

POWER BIPOLAR TRANSISTORS

DATABOOK

1st EDITION

JUNE 1989

USE IN LIFE SUPPORT MUST BE EXPRESSLY AUTHORIZED

SGS-THOMSON' PRODUCTS ARE NOT AUTHORIZED FOR USE AS CRITICAL COMPONENTS IN LIFE SUPPORT DEVICES OR SYSTEMS WITHOUT THE EXPRESS WRITTEN APPROVAL OF THE PRESIDENT OF SGS-THOMSON Microelectronics. As used herein:

1. Life support devices to systems are devices or systems which, are intended for surgical implant into the body to support or sustain life, and whose failure to perform, when properly used in accordance with instructions for use provided in the labeling, can be reasonably expected to result in a significant injury to the user.
2. A critical component is any component of a life support device or system whose failure to perform can be reasonably expected to cause the failure of the life support device or system, or to affect its safety or effectiveness.

TABLE OF CONTENTS

INTRODUCTION	Page	5
General Information		7
Technologies Overview		8
Selection Guide by Part Number		
- General Purpose		14
- Switching Transistors		24
Selection Guide by Voltage		
- General Purpose		33
- Switching Transistors		39
Selection Guide by Package		
- General Purpose		48
- Switching Transistors		57
Cross Reference		69
Alphabetical List of Symbols		92
Rating Systems for Electronic Devices		94
Handling of Power Plastic Transistors		95
Accessories and Mounting Instruction		98
Isowatt Packages Informations		108
TOP-3I Information		111
Extension of FBSOA Above the BV_{CEO}		112
Improved Specification for Power Transistors		122

DATASHEETS	131
-------------------	------------

PACKAGES	1189
-----------------	-------------

INTRODUCTION

This Power Bipolar Transistor DATABOOK contains data on the range of the Company's discrete BIPOLAR POWER devices for applications in industrial, automotive, computer, telecommunication, professional, and consumer equipment.

Introduced for the first time are ETD transistors for high voltage, high reliability applications, that are made using a new cellular emitter technology. Also introduced for many devices is the option of an ISOLATED PACKAGE, either ISOWATT220, ISOWATT218, or TOP 3I.

Selection guides are provided in the following pages to facilitate rapid identification of the most suitable device for the intended use.

The extensive information makes it easy to evaluate the performance of the product within any required equipment design.

This DATABOOK is complemented by the POWER TRANSISTOR APPLICATION MANUAL (order code AMPOWTRANST/1) which is a collection of technical notes concerning POWER TRANSISTORS.

EPITAXIAL BASE - I_{CM} UP TO 30A; V_{CEO} UP TO 100V

MAIN FEATURES

- NPN and PNP types (perfect complementary pairs)
- Medium switching speed
- Medium f_T (2 to 20 MHz)
- High ruggedness

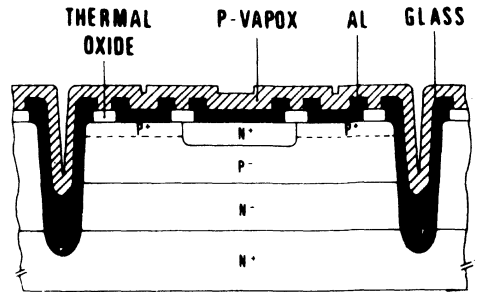

INTERNAL SCHEMATIC DIAGRAMS

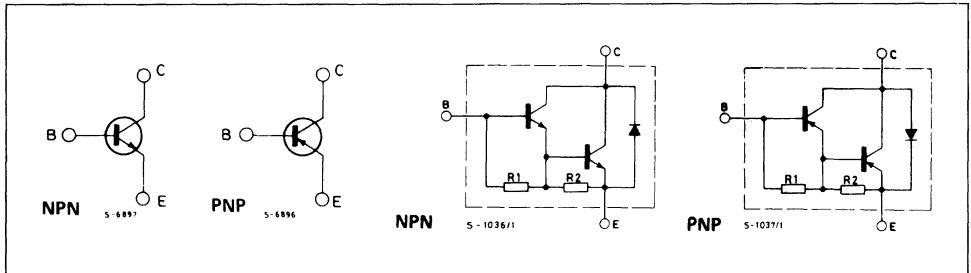

Epitaxial Base Technology is a general purpose low voltage technology for NPN/PNP transistors and monolithic Darlingtonts.

This low voltage complementary technology consists of epitaxial layers of N and P type silicon. The emitter efficiency is maximized by the appropriate choice of emitter geometry.

In this technology the base is obtained by an epitaxial growth.

The thickness of the base epitaxy and the impurity level control obtained during the process enables the production of perfect complementary devices.

This makes them ideally suited for applications where a V_{CEO} rating of up to 100 V is required

with breakdown voltages of 200V, and transition frequencies up to 20 MHz.

Due to the base obtained by epitaxial growth, a mesa channel is then etched that defines the base-collector junction and allows the devices to be separated from each other. The mesa channel is then passivated with glass.

While epitaxial base transistors give high ruggedness to forward secondary breakdown, their switching speed makes epitaxial base transistors the ideal choice for general purpose uses.

Applications include amplifiers, regulators, switches and drivers produced in a wide range of packages, such as the TIP, BD, 2N and MJE series transistors and Darlingtonts.

EPITAXIAL PLANAR - I_{CM} UP TO 70A; V_{CEO} UP TO 350V

MAIN FEATURES

- NPN and PNP types
- Good voltage capability (V_{CES} up to 450V)
- Good h_{FE} linearity
- Low saturation voltage
- Low leakage
- Very high f_T (up to 100 MHz)
- Very high speed
- Rugged
- Total base-collector passivation

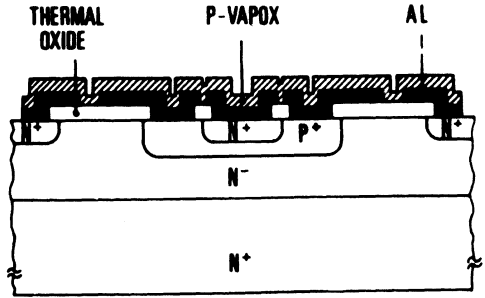

INTERNAL SCHEMATIC DIAGRAMS

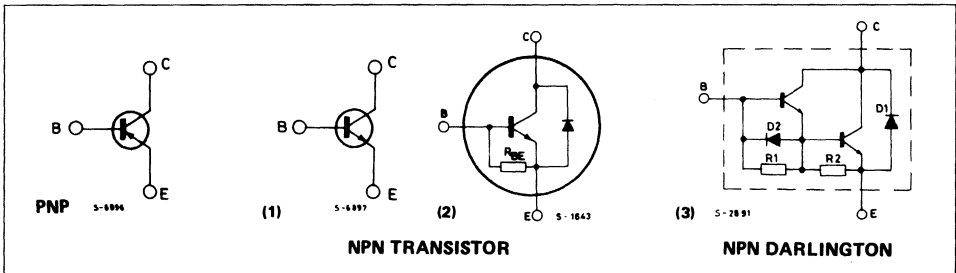

Epitaxial planar is a medium voltage fast switching technology for NPN/PNP transistors and monolithic NPN Darlington. This medium voltage technology consists of epitaxial layers of N or P type silicon whose planar construction method permits very high speed switching, a low saturation voltage, and low leakage. The emitter efficiency is maximized by an appropriate choice of emitter geometry.

The base is obtained by a planar diffusion into the epitaxially grown collector.

These features make it ideally suited for applica-

tions where a V_{CEO} rating of up-to 200 V is required and cut-off frequencies up to 100 MHz; the breakdown voltage can be as high as 450V. Epitaxial planar transistors are characterized by high speed, and are generally produced for medium power applications in SOT-32 and TO-220 packages.

Applications include drivers, DC-DC converters and general fast switching uses. A family of NPN Darlington and transistors are produced for monochrome deflection applications.

MULTIEPITAXIAL PLANAR - I_{CM} UP TO 70A; V_{CEO} UP TO 450V

MAIN FEATURES

- NPN types
- I_C range up to 70A
- Good h_{FE} linearity
- Low leakage
- High switching speed
- Total base-collector passivation

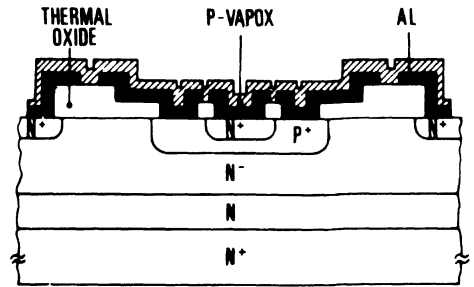

INTERNAL SCHEMATIC DIAGRAMS

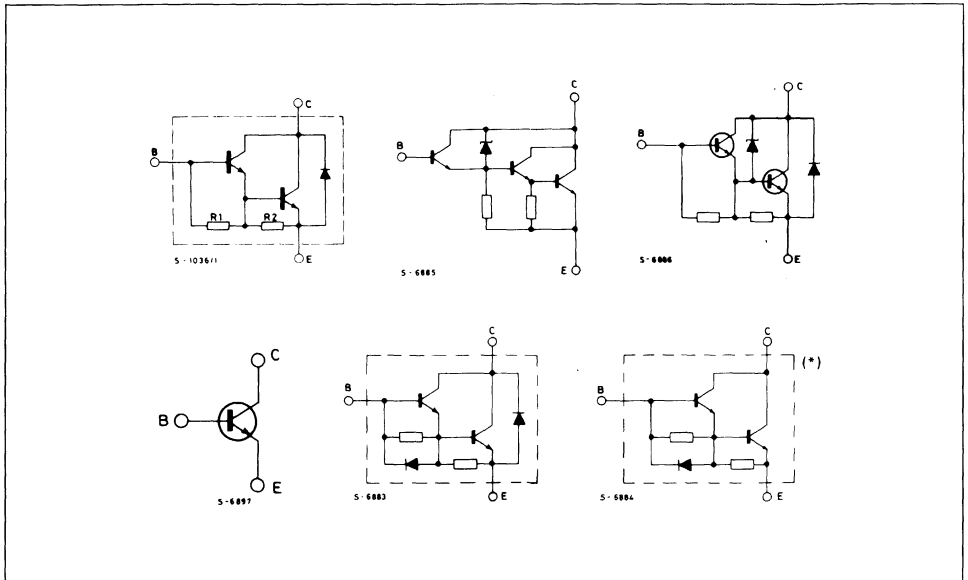

Multiepitaxial planar technology is a medium voltage, rugged, high switching speed technology for NPN transistors and Darlington's, with or without collector-emitter protective diodes.

This medium voltage technology consists of epitaxial layers of N type silicon: an additional energy layer of N type silicon in the collector region increases the ruggedness of the device while operating in the RBSOA. The emitter efficiency is maximized by the appropriate choice of emitter geometry.

The base is obtained by a planar diffusion inside the epitaxial collector.

These features make this technology ideally suited for applications where a V_{EO} rating of up to 450 V is required at high switching speeds. The breakdown voltage boundary is around 800V. Applications include high power DC-DC converters and motor controls. A very high gain Trilington is also produced for automotive applications.

MULTIEPITAXIAL MESA - I_{CM} UP TO 30A; V_{CEO} UP TO 700V

MAIN FEATURES

- NPN type
- High voltage (V_{CES} UP TO 1500V)
- High power
- Very good $I_{s/b}$ and $E_{s/b}$ performance)
- High switching speed
- High f_T (20MHz)

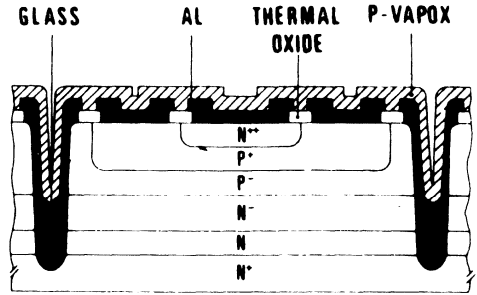

INTERNAL SCHEMATIC DIAGRAM

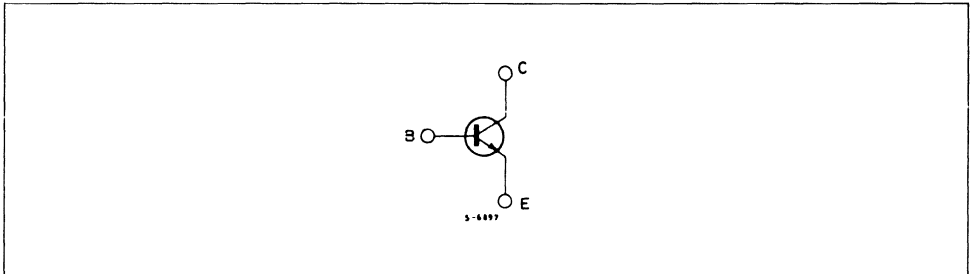

The multi-epitaxial mesa technology is used to produce high voltage and fast switching NPN transistors, and NPN Darlingtons. NPN medium voltage devices, with V_{CES} up to 500V are also produced.

While in the epitaxial base technology the base is obtained by an epitaxial layer, in the multi-epitaxial mesa it is made up of two parts. Firstly an epitaxial base is grown as in the epibase technology. Then inside it a masked diffusion takes place. As a result, two different base regions are created: the epitaxial P^- region close to the mesa channel and the active region that consist of a P^+ diffusion plus the underlying residual P^- epitaxial region. This base structure allows the reduction of the electric field both at the die surface and in the mesa channel zone, with an excellent effect on the reliability. The intermediate energy layer N between the N^-

collector and the N^+ substrate strongly improve the RBSOA characteristics. The high power density generated in the crystal during switching transients is safely dispersed in the thickness of the energy layer avoiding risky hot spots.

A deep mesa channel is then etched to allow the separation of devices and to define the base-collector junction.

Additionally, as well as passivating the mesa channel with glass, an aluminium equipotential ring (EQR) is deposited around the upper outer edge of the mesa channel. This EQR is at the same potential as the collector to provide a well defined and controlled boundary for the electric field.

Applications for this high voltage and very rugged technology include: off-line switching power supplies, lamp ballast, CTV deflection and motor control.

MULTIEPITAXIAL MESA HOLLOW EMITTER - I_{CM} UP TO 12A; V_{CEO} UP TO 450V

MAIN FEATURES

- Suitable for high frequency switching power supplies
- NPN types
- High voltage (V_{CBO} up to 1300V)
- High power
- Very good $I_{s/b}$ and $E_{s/b}$ performance
- Very high switching speed up to 70 KHz

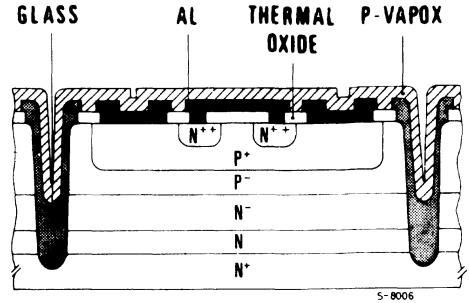

INTERNAL SCHEMATIC DIAGRAM

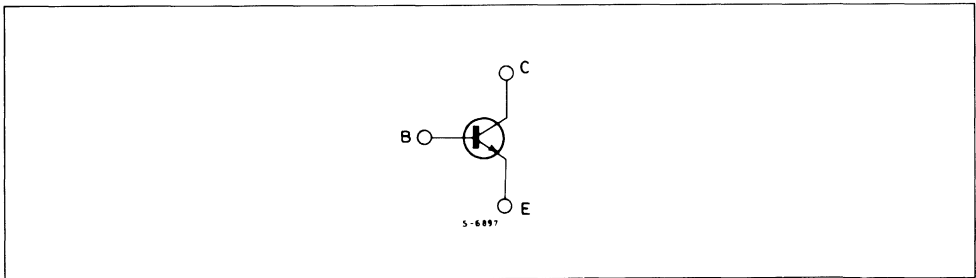

The Multiepitaxial Mesa FASTSWITCH technology is an improvement of the established and proven multiepitaxial mesa process. This new technology is used to produce high voltage and very fast switching NPN transistors.

Multiepitaxial Mesa FASTSWITCH technology consists of epitaxial layers of N and P type silicon, a thin intermediate energy layer and a glass filled mesa around the edge of the chip.

A hollow emitter geometry reduces charge crow-

ding under the emitter and improves turn-off time. This features and a thinner energy layer, which lowers the saturation voltage, optimize the performance of this technology for high voltage and very fast switching applications.

Low dynamic saturation, very fast switching and high voltage capability make this technology ideal for off-line switching power supplies, lamp ballast and high line rate CTV deflection applications.

MULTIEPITAXIAL PLANAR ETD™ - I_{CM} UP TO 30A; V_{CEO} UP TO 450V

MAIN FEATURES

- Suitable for high efficiency power conversion
- NPN types
- High voltage (V_{CEV} UP TO 1000V)
- High power (switching up to 12kVA)
- Optimised multicellular emitter design
- Excellent RBSOA
- Very high switching speed - up to 100kHz
- Simplified base drive

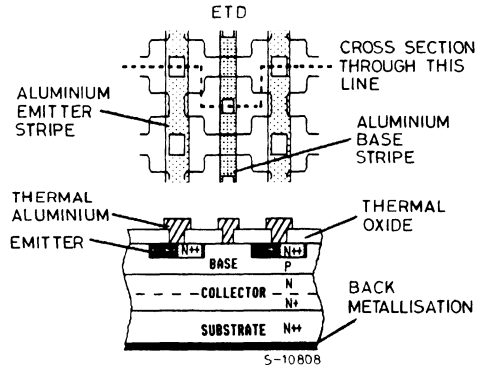

INTERNAL SCHEMATIC DIAGRAM

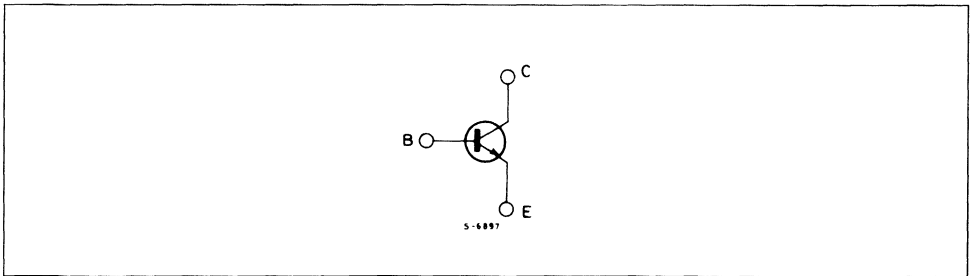

The Multiepitaxial planar ETD technology is an optimisation of the multiepitaxial planar process. This new technology is used to produce high voltage, very fast switching transistors with very low losses. The intermediate energy layer N, between the N^+ substrate and the N collector layer, improves the RBSOA. The P^- base ring diffusion allows to reach the bulk avalanche limit: this in turn allows the N collector layer thickness to be optimised, and improves the device's reliability.

The planar diffused base and multicellular emitter structure provides very high switching speeds and avoids charge crowding under the emitter area. The low dynamic and static losses together with the very fast switching and high voltage rating make this technology ideal for professional and industrial equipment such as off-line power supplies, power conversion and motor controls.

SELECTION GUIDE BY PART NUMBER

GENERAL PURPOSE TRANSISTORS

Type	Complementary	V _{CEO} (V)	V _{CBO} (V)	I _C (A)	h _{FE} @		V _{CE} (V)	V _{CEsat} @		I _B (mA)	R _{thj-c} (°C/W)	Case	Page
					I _C (A)	I _C (A)		I _C (A)	I _C (A)				
2N3055	MJ2955	60	100	15	20	4.00	4.0	1.10	4.00	400	1.5	TO - 3	1399
2N3715	2N3791	60	80	10	30	3.00	2.0	0.80	5.00	500	1.17	TO - 3	1047
2N3716	2N3792	80	100	10	30	3.00	2.0	0.80	5.00	500	1.17	TO - 3	1047
2N3771		40	50	15	15	15.00	4.0	2.00	15.00	1500	1.17	TO - 3	1053
2N3772		60	100	15	15	10.00	4.0	1.40	10.00	1000	1.17	TO - 3	1053
2N3791	2N3715	60	80	10	30	3.00	2.0	0.80	5.00	500	1.17	TO - 3	1047
2N3792	2N3716	80	100	10	30	3.00	2.0	0.80	5.00	500	1.17	TO - 3	1047
2N4234		40	40	3	20	0.50	1.0	0.60	1.00	100	29	TO - 39	1057
2N4398	2N5301	40	40	30	15	15.00	2.0	1.00	15.00	1500	0.875	TO - 3	1083
2N4399	2N5302	60	60	30	15	15.00	2.0	1.00	15.00	1500	0.875	TO - 3	1083
2N4918	2N4921	40	40	1	30	0.50	1.0	0.60	1.00	100	4.16	SOT - 32	1063
2N4919	2N4922	60	60	1	30	0.50	1.0	0.60	1.00	100	4.16	SOT - 32	1063
2N4920	2N4923	80	80	1	30	0.50	1.0	0.60	1.00	100	4.16	SOT - 32	1063
2N4921	2N4918	40	40	1	30	0.50	1.0	0.60	1.00	100	4.16	SOT - 32	1063
2N4922	2N4919	60	60	1	30	0.50	1.0	0.60	1.00	100	4.16	SOT - 32	1063
2N4923	2N4920	80	80	1	30	0.50	1.0	0.60	1.00	100	4.16	SOT - 32	1063
2N5151	2N5152	80	100	5	30	2.50	5.0	0.70	2.50	250	15	TO - 39	1073
2N5152	2N5151	80	100	5	30	2.50	5.0	0.70	2.50	250	15	TO - 39	1075
2N5153	2N5154	80	100	5	70	2.50	5.0	0.70	2.50	250	15	TO - 39	1073
2N5154	2N5153	80	100	5	70	2.50	5.0	0.70	2.50	250	15	TO - 39	1075
2N5190	2N5193	40	40	4	25	1.50	2.0	0.60	1.50	150	3.12	SOT - 32	1077
2N5191	2N5194	60	60	4	25	1.50	2.0	0.60	1.50	150	3.12	SOT - 32	1077
2N5192	2N5195	80	80	4	20	1.50	2.0	0.60	1.50	150	3.12	SOT - 32	1077
2N5193	2N5190	40	40	4	25	1.50	2.0	0.60	1.50	150	3.12	SOT - 32	1077
2N5194	2N5191	60	60	4	25	1.50	2.0	0.60	1.50	150	3.12	SOT - 32	1077
2N5195	2N5192	80	80	4	20	1.50	2.0	0.60	1.50	150	3.12	SOT - 32	1077
2N5301	2N4398	40	40	30	15	15.00	2.0	1.00	15.00	1500	0.875	TO - 3	1083
2N5302	2N4399	60	60	30	15	15.00	2.0	1.00	15.00	1500	0.875	TO - 3	1083
2N5303	2N5745	80	80	20	15	10.00	2.0	1.50	15.00	1500	0.875	TO - 3	1083
2N5336		80	80	5	20	5.00	2.0	1.20	5.00	500	29	TO - 39	1089
2N5337		80	80	5	40	5.00	2.0	1.20	5.00	500	29	TO - 39	1089
2N5338		100	100	5	20	5.00	2.0	1.20	5.00	500	29	TO - 39	1089
2N5339		100	100	5	40	5.00	2.0	1.20	5.00	500	29	TO - 39	1089
2N5629	2N6029	100	100	16	25	8.00	2.0	1.00	10.00	1000	0.875	TO - 3	1097
2N5679	2N5681	100	100	1	40	0.25	2.0	1.00	0.50	50	17.5	TO - 39	1111
2N5680	2N5682	120	120	1	40	0.25	2.0	1.00	0.50	50	17.5	TO - 39	1111
2N5681	2N5679	100	100	1	40	0.25	2.0	1.00	0.50	50	17.5	TO - 39	1113
2N5682	2N5680	120	120	1	40	0.25	2.0	1.00	0.50	50	17.5	TO - 39	1113
2N5745	2N5303	80	80	20	15	10.00	2.0	1.50	15.00	1500	0.875	TO - 3	1083
2N5875	2N5877	60	60	10	20	4.00	4.0	1.00	5.00	500	1.17	TO - 3	1115
2N5876	2N5878	80	80	10	20	4.00	4.0	1.00	5.00	500	1.17	TO - 3	1115
2N5877	2N5875	60	60	10	20	4.00	4.0	1.00	5.00	500	1.17	TO - 3	1115
2N5878	2N5876	80	80	10	20	4.00	4.0	1.00	5.00	500	1.17	TO - 3	1115
2N5883	2N5885	60	60	25	20	10.00	4.0	1.00	15.00	1500	0.875	TO - 3	1121
2N5884	2N5886	80	80	25	20	10.00	4.0	1.00	15.00	1500	0.875	TO - 3	1121

PNP Type in bold.

GENERAL PURPOSE TRANSISTORS (cont'd)

Type	Complementary	V _{CEO} (V)	V _{CBO} (V)	I _C (A)	h _{FE} @ I _C (A)	V _{CE} (V)	V _{CEsat} @ (V)	I _C (A)	I _B (mA)	R _{thj-c} (°C/W)	Case	Page	
2N5885	2N5883	60	60	25	20	10.00	4.0	1.00	15.00	1500	0.875	TO - 3	1121
2N5886	2N5884	80	80	25	20	10.00	4.0	1.00	15.00	1500	0.875	TO - 3	1121
2N6029	2N5629	100	100	16	25	8.00	2.0	1.00	10.00	1000	0.875	TO - 3	1097
2N6034	2N6037	40	40	4	500	0.50	3.0	2.00	2.00	8	3.12	SOT - 32	1131
2N6035	2N6038	60	60	4	500	0.50	3.0	2.00	2.00	8	3.12	SOT - 32	1131
2N6036	2N6039	80	80	4	500	0.50	3.0	2.00	2.00	8	3.12	SOT - 32	1131
2N6037	2N6034	40	40	4	500	0.50	3.0	2.00	2.00	8	3.12	SOT - 32	1131
2N6038	2N6035	60	60	4	500	0.50	3.0	2.00	2.00	8	3.12	SOT - 32	1131
2N6039	2N6036	80	80	4	500	0.50	3.0	2.00	2.00	8	3.12	SOT - 32	1131
2N6042	2N6045	100	100	8	1000	3.00	4.0	2.00	3.00	12	1.56	TO - 220	1135
2N6045	2N6042	100	100	8	1000	3.00	4.0	2.00	3.00	12	1.56	TO - 220	1135
2N6050	2N6057	60	60	12	750	6.00	3.0	2.00	6.00	24	1.17	TO - 3	1137
2N6051	2N6058	80	80	12	750	6.00	3.0	2.00	6.00	24	1.17	TO - 3	1137
2N6052	2N6059	100	100	12	750	6.00	3.0	2.00	6.00	24	1.17	TO - 3	1137
2N6053	2N6055	60	60	8	750	4.00	3.0	2.00	4.00	16	1.75	TO - 3	1139
2N6055	2N6053	60	60	8	750	4.00	3.0	2.00	4.00	16	1.75	TO - 3	1139
2N6057	2N6050	60	60	12	750	6.00	3.0	2.00	6.00	24	1.17	TO - 3	1137
2N6058	2N6051	80	80	12	750	6.00	3.0	2.00	6.00	24	1.17	TO - 3	1137
2N6059	2N6052	100	100	12	750	6.00	3.0	2.00	6.00	24	1.17	TO - 3	1137
2N6107	2N6292	70	80	7	30	4.00	2.0	1.00	2.00	200	3.12	TO - 220	1141
2N6109	2N6290	50	60	7	30	4.00	2.5	1.00	2.50	250	3.12	TO - 220	1141
2N6111	2N6288	30	40	7	30	4.00	3.0	1.00	3.00	300	1.92	TO - 220	1141
2N6121	2N6124	45	45	4	25	1.00	2.0	0.60	1.50	150	3.12	TO - 220	1143
2N6122	2N6125	60	60	4	25	1.50	2.0	0.60	1.50	150	3.12	TO - 220	1143
2N6123	2N6126	80	80	4	20	1.50	2.0	0.60	1.50	150	3.12	TO - 220	1143
2N6124	2N6121	45	45	4	25	1.00	2.0	0.60	1.50	150	3.12	TO - 220	1143
2N6125	2N6122	60	60	4	25	1.50	2.0	0.60	1.50	150	3.12	TO - 220	1143
2N6126	2N6123	80	80	4	20	1.50	2.0	0.60	1.50	150	3.12	TO - 220	1143
2N6282	2N6285	60	60	20	750	10.00	3.0	3.00	20.00	200	1.09	TO - 3	1149
2N6283	2N6286	80	80	20	750	10.00	3.0	3.00	20.00	200	1.09	TO - 3	1149
2N6284	2N6287	100	100	20	750	10.00	3.0	3.00	20.00	200	1.09	TO - 3	1149
2N6285	2N6282	60	60	20	750	10.00	3.0	3.00	20.00	200	1.09	TO - 3	1149
2N6286	2N6283	80	80	20	750	10.00	3.0	3.00	20.00	200	1.09	TO - 3	1149
2N6287	2N6284	100	100	20	750	10.00	3.0	3.00	20.00	200	1.09	TO - 3	1149
2N6288	2N6111	30	40	7	30	4.00	3.0	1.00	3.00	300	1.92	TO - 220	1141
2N6290	2N6109	50	60	7	30	4.00	2.5	1.00	2.50	250	3.12	TO - 220	1141
2N6292	2N6107	70	80	7	30	4.00	2.0	1.00	2.00	200	3.12	TO - 220	1141
2N6386		40	40	8	1000	3.00	3.0	2.00	3.00	6	1.92	TO - 220	1153
2N6387		60	60	10	1000	5.00	3.0	2.00	5.00	10	1.92	TO - 220	1153
2N6388		80	80	10	1000	5.00	3.0	2.00	5.00	10	1.92	TO - 220	1153
2N6486	2N6489	50	50	15	20	5.00	4.0	1.30	5.00	500	1.67	TO - 220	1157
2N6487	2N6490	70	70	15	20	5.00	4.0	1.30	5.00	500	1.67	TO - 220	1157
2N6488	2N6491	90	90	15	20	5.00	4.0	1.30	5.00	500	1.67	TO - 220	1157
2N6489	2N6486	50	50	15	20	5.00	4.0	1.30	5.00	500	1.67	TO - 220	1157
2N6490	2N6487	70	70	15	20	5.00	4.0	1.30	5.00	500	1.67	TO - 220	1157

PNP Type in bold.

SELECTION GUIDE BY PART NUMBER

GENERAL PURPOSE TRANSISTORS (cont'd)

Type	Complementary	V _{CEO} (V)	V _{CBO} (V)	I _C (A)	h _{FE} @ I _C (A)	V _{CE} (V)	V _{CEsat} (V)	I _C (A)	I _B (mA)	R _{thj-c} (°C/W)	Case	Page	
2N6491	2N6488	90	90	15	20	5.00	4.0	1.30	5.00	500	1.67	TO - 220	1157
BD135	BD136	45	45	1.5	25	0.50	2.0	0.50	0.50	50	10	SOT - 32	133
BD136	BD135	45	45	1.5	25	0.50	2.0	0.50	0.50	50	10	SOT - 32	137
BD137	BD138	60	60	1.5	25	0.50	2.0	0.50	0.50	50	10	SOT - 32	133
BD138	BD137	60	60	1.5	25	0.50	2.0	0.50	0.50	50	10	SOT - 32	137
BD139	BD140	80	80	1.5	25	0.50	2.0	0.50	0.50	50	10	SOT - 32	133
BD140	BD139	80	80	1.5	25	0.50	2.0	0.50	0.50	50	10	SOT - 32	137
BD175	BD176	45	45	3	15	1.00	2.0	0.80	1.00	100	4.16	SOT - 32	143
BD176	BD175	45	45	3	15	1.00	2.0	0.80	1.00	100	4.16	SOT - 32	143
BD177	BD178	60	60	3	15	1.00	2.0	0.80	1.00	100	4.16	SOT - 32	143
BD178	BD177	60	60	3	15	1.00	2.0	0.80	1.00	100	4.16	SOT - 32	143
BD179	BD180	80	80	3	15	1.00	2.0	0.80	1.00	100	4.16	SOT - 32	143
BD180	BD179	80	80	3	15	1.00	2.0	0.80	1.00	100	4.16	SOT - 32	143
BD233	BD234	45	45	2	25	1.00	2.0	0.60	1.00	100	5	SOT - 32	149
BD234	BD233	45	45	2	25	1.00	2.0	0.60	1.00	100	5	SOT - 32	149
BD235	BD236	60	60	2	25	1.00	2.0	0.60	1.00	100	5	SOT - 32	149
BD236	BD235	60	60	2	25	1.00	2.0	0.60	1.00	100	5	SOT - 32	149
BD237	BD238	80	100	2	25	1.00	2.0	0.60	1.00	100	5	SOT - 32	149
BD238	BD237	80	100	2	25	1.00	2.0	0.60	1.00	100	5	SOT - 32	149
BD239	BD240	45	45	2	15	1.00	4.0	0.70	1.00	200	4.16	TO - 220	153
BD239A	BD240A	60	60	2	15	1.00	4.0	0.70	1.00	200	3.12	TO - 220	153
BD239B	BD240B	80	80	2	15	1.00	4.0	0.70	1.00	200	4.16	TO - 220	153
BD239C	BD240C	100	100	2	15	1.00	4.0	0.70	1.00	200	4.16	TO - 220	153
BD240	BD239	45	45	2	15	1.00	4.0	0.70	1.00	200	4.16	TO - 220	153
BD240A	BD239A	60	60	2	15	1.00	4.0	0.70	1.00	200	3.12	TO - 220	153
BD240B	BD239B	80	80	2	15	1.00	4.0	0.70	1.00	200	4.16	TO - 220	153
BD240C	BD239C	100	100	2	15	1.00	4.0	0.70	1.00	200	4.16	TO - 220	153
BD241	BD242	45	45	3	25	1.00	4.0	1.20	3.00	600	4.16	TO - 220	155
BD241A	BD242A	60	60	3	25	1.00	4.0	1.20	3.00	600	3.12	TO - 220	155
BD241B	BD242B	80	80	3	25	1.00	4.0	1.20	3.00	600	3.12	TO - 220	155
BD241C	BD242C	100	100	3	25	1.00	4.0	1.20	3.00	600	3.12	TO - 220	155
BD242	BD241	45	45	3	25	1.00	4.0	1.20	3.00	600	4.16	TO - 220	155
BD242A	BD241A	60	60	3	25	1.00	4.0	1.20	3.00	600	3.12	TO - 220	155
BD242B	BD241B	80	80	3	25	1.00	4.0	1.20	3.00	600	3.12	TO - 220	155
BD242C	BD241C	100	100	3	25	1.00	4.0	1.20	3.00	600	3.12	TO - 220	155
BD243	BD244	45	45	6	15	3.00	4.0	1.50	6.00	1000	4.16	TO - 220	157
BD243A	BD244A	60	60	6	15	3.00	4.0	1.50	6.00	1000	3.12	TO - 220	157
BD243B	BD244B	80	80	6	15	3.00	4.0	1.50	6.00	1000	1.92	TO - 220	157
BD243C	BD244C	100	100	6	15	3.00	4.0	1.50	6.00	1000	3.12	TO - 220	157
BD244	BD243	45	45	6	15	3.00	4.0	1.50	6.00	1000	4.16	TO - 220	157
BD244A	BD243A	60	60	6	15	3.00	4.0	1.50	6.00	1000	3.12	TO - 220	157
BD244B	BD243B	80	80	6	15	3.00	4.0	1.50	6.00	1000	1.92	TO - 220	157
BD244C	BD243C	100	100	6	15	3.00	4.0	1.50	6.00	1000	3.12	TO - 220	157
BD331	BD332	60	60	6	750	3.00	3.0	2.00	3.00	12	2.08	SOT - 82	159
BD332	BD331	60	60	6	750	3.00	3.0	2.00	3.00	12	2.08	SOT - 82	159

PNP Type in bold.

GENERAL PURPOSE TRANSISTORS (cont'd)

Type	Complementary	V _{CEO} (V)	V _{CB0} (V)	I _C (A)	h _{FE} @ I _C (A)	V _{CE} (V)	V _{CEsat} @ I _C (V)	I _B (mA)	R _{thj-c} (°C/W)	Case	Page		
BD333	BD334	80	80	6	750	3.00	3.0	2.00	3.00	12	2.08	SOT - 82	159
BD334	BD333	80	80	6	750	3.00	3.0	2.00	3.00	12	2.08	SOT - 82	159
BD335	BD336	100	100	6	750	3.00	3.0	2.00	3.00	12	2.08	SOT - 82	159
BD336	BD335	100	100	6	750	3.00	3.0	2.00	3.00	12	2.08	SOT - 82	159
BD433	BD434	22	22	4	50	2.00	1.0	0.50	2.00	200	3.5	SOT - 32	163
BD434	BD433	22	22	4	50	2.00	1.0	0.50	2.00	200	3.5	SOT - 32	163
BD435	BD436	32	32	4	50	2.00	1.0	0.50	2.00	200	3.5	SOT - 32	163
BD436	BD435	32	32	4	50	2.00	1.0	0.50	2.00	200	3.5	SOT - 32	163
BD437	BD438	45	45	4	40	2.00	1.0	0.60	2.00	200	3.5	SOT - 32	163
BD438	BD437	45	45	4	40	2.00	1.0	0.60	2.00	200	3.5	SOT - 32	163
BD439	BD440	60	60	4	25	2.00	1.0	0.80	2.00	200	3.5	SOT - 32	169
BD440	BD439	60	60	4	25	2.00	1.0	0.80	2.00	200	3.5	SOT - 32	169
BD441	BD442	80	80	4	15	2.00	1.0	0.80	2.00	200	3.5	SOT - 32	169
BD442	BD441	80	80	4	15	2.00	1.0	0.80	2.00	200	3.5	SOT - 32	169
BD533	BD534	45	45	8	25	2.00	2.0	0.80	2.00	200	2.5	TO - 220	171
BD534	BD533	45	45	8	25	2.00	2.0	0.80	2.00	200	2.5	TO - 220	171
BD535	BD536	60	60	8	25	2.00	2.0	0.80	2.00	200	2.5	TO - 220	171
BD536	BD535	60	60	8	25	2.00	2.0	0.80	2.00	200	2.5	TO - 220	171
BD537	BD538	80	80	8	15	2.00	2.0	0.80	2.00	200	2.5	TO - 220	171
BD538	BD537	80	80	8	15	2.00	2.0	0.80	2.00	200	2.5	TO - 220	171
BD675	BD676	45	45	4	750	1.50	3.0	2.50	1.50	30	3.12	SOT - 32	175
BD675A	BD676A	45	45	4	750	2.00	3.0	2.80	2.00	40	3.12	SOT - 32	175
BD676	BD675	45	45	4	750	1.50	3.0	2.50	1.50	30	3.12	SOT - 32	175
BD676A	BD675A	45	45	4	750	2.00	3.0	2.80	2.00	40	3.12	SOT - 32	175
BD677	BD678	60	60	4	750	1.50	3.0	2.50	1.50	30	3.12	SOT - 32	175
BD677A	BD678A	60	60	4	750	2.00	3.0	2.80	2.00	40	3.12	SOT - 32	175
BD678	BD677	60	60	4	750	1.50	3.0	2.50	1.50	30	3.12	SOT - 32	175
BD678A	BD677A	60	60	4	750	2.00	3.0	2.80	2.00	40	3.12	SOT - 32	175
BD679	BD680	80	80	4	750	1.50	3.0	2.50	1.50	30	3.12	SOT - 32	175
BD679A	BD680A	80	80	4	750	2.00	3.0	2.80	2.00	40	3.12	SOT - 32	175
BD680	BD679	80	80	4	750	1.50	3.0	2.50	1.50	30	3.12	SOT - 32	175
BD680A	BD679A	80	80	4	750	2.00	3.0	2.80	2.00	40	3.12	SOT - 32	175
BD681	BD682	100	100	4	750	1.50	3.0	2.50	1.50	30	3.12	SOT - 32	175
BD682	BD681	100	100	4	750	1.50	3.0	2.50	1.50	30	3.12	SOT - 32	175
BD705	BD706	45	45	12	20	4.00	4.0	1.00	4.00	400	1.67	TO - 220	179
BD706	BD705	45	45	12	20	4.00	4.0	1.00	4.00	400	1.67	TO - 220	179
BD707	BD708	60	60	12	15	4.00	4.0	1.00	4.00	400	1.67	TO - 220	179
BD708	BD707	60	60	12	15	4.00	4.0	1.00	4.00	400	1.67	TO - 220	179
BD709	BD710	80	80	12	15	4.00	4.0	1.00	4.00	400	1.67	TO - 220	179
BD710	BD709	80	80	12	15	4.00	4.0	1.00	4.00	400	1.67	TO - 220	179
BD711	BD712	100	100	12	15	4.00	4.0	1.00	4.00	400	1.4	TO - 220	179
BD712	BD711	100	100	12	15	4.00	4.0	1.00	4.00	400	1.4	TO - 220	179
BD905	BD906	45	45	15	15	5.00	4.0	1.00	5.00	500	1.4	TO - 220	185
BD906	BD905	45	45	15	15	5.00	4.0	1.00	5.00	500	1.4	TO - 220	185
BD907	BD908	60	60	15	15	5.00	4.0	1.00	5.00	500	1.4	TO - 220	185
BD908	BD907	60	60	15	15	5.00	4.0	1.00	5.00	500	1.4	TO - 220	185

PNP Type in bold.

GENERAL PURPOSE TRANSISTORS (cont'd)

Type	Complementary	V _{CEO} (V)	V _{CBO} (V)	I _C (A)	h _{FE} @ I _C (A)	V _{CE} (V)	V _{CEsat} (V)	I _C (A)	I _B (mA)	R _{thj-c} (°C/W)	Case	Page	
BD908	BD907	60	60	15	15	5.00	4.0	1.00	5.00	500	1.4	TO - 220	185
BD909	BD910	80	80	15	15	5.00	4.0	1.00	5.00	500	1.4	TO - 220	185
BD910	BD909	80	80	15	15	5.00	4.0	1.00	5.00	500	1.4	TO - 220	185
BD911	BD912	100	100	15	15	5.00	4.0	1.00	5.00	500	4.2	TO - 220	185
BD912	BD911	100	100	15	15	5.00	4.0	1.00	5.00	500	4.2	TO - 220	185
BDV64	BDV65	60	60	12	1000	5.00	4.0	2.00	5.00	20	1	TO - 218	189
BDV64A	BDV65A	80	80	12	1000	5.00	4.0	2.00	5.00	20	1	TO - 218	189
BDV65	BDV65B	100	100	12	1000	5.00	4.0	2.00	5.00	20	1	TO - 218	189
BDV64B	BDV64	60	60	12	1000	5.00	4.0	2.00	5.00	20	1	TO - 218	189
BDV65A	BDV64A	80	80	12	1000	5.00	4.0	2.00	5.00	20	1	TO - 218	189
BDV65B	BDV65B	100	100	12	1000	5.00	4.0	2.00	5.00	20	1	TO - 218	189
BDW51	BDW52	45	45	15	20	5.00	4.0	1.00	5.00	500	1.4	TO - 3	193
BDW51A	BDW52A	60	60	15	20	5.00	4.0	1.00	5.00	500	1.4	TO - 3	193
BDW51B	BDW52B	80	80	15	20	5.00	4.0	1.00	5.00	500	1.4	TO - 3	193
BDW51C	BDW52C	100	100	15	20	5.00	4.0	1.00	5.00	500	1.4	TO - 3	193
BDW52	BDW51	45	45	15	20	5.00	4.0	1.00	5.00	500	1.4	TO - 3	193
BDW52A	BDW51A	60	60	15	20	5.00	4.0	1.00	5.00	500	1.4	TO - 3	193
BDW52B	BDW51B	80	80	15	20	5.00	4.0	1.00	5.00	500	1.4	TO - 3	193
BDW52C	BDW51C	100	100	15	20	5.00	4.0	1.00	5.00	500	1.4	TO - 3	193
BDW83A	BDW84A	60	60	15	750	6.00	3.0	2.50	6.00	12	0.96	TO - 218	199
BDW83B	BDW84B	80	80	15	750	6.00	3.0	2.50	6.00	12	0.96	TO - 218	199
BDW83C	BDW84C	100	100	15	750	6.00	3.0	2.50	6.00	12	0.96	TO - 218	199
BDW84A	BDW83A	60	60	15	750	6.00	3.0	2.50	6.00	12	0.96	TO - 218	199
BDW84B	BDW83B	80	80	15	750	6.00	3.0	2.50	6.00	12	0.96	TO - 218	199
BDW84C	BDW83C	100	100	15	750	6.00	3.0	2.50	6.00	12	0.96	TO - 218	199
BDW91	BDW92	180	180	4	1000	2.00	5.0	2.00	2.00	4	17.5	TO - 39	201
BDW92	BDW91	180	180	4	1000	2.00	5.0	2.00	2.00	4	17.5	TO - 39	201
BDW93	BDW94	45	45	12	750	5.00	3.0	2.00	5.00	20	1.56	TO - 220	205
BDW93A	BDW94A	60	60	12	750	5.00	3.0	2.00	5.00	20	1.56	TO - 220	205
BDW93B	BDW94B	80	80	12	750	5.00	3.0	2.00	5.00	20	1.56	TO - 220	205
BDW93C	BDW94C	100	100	12	750	5.00	3.0	2.00	5.00	20	1.56	TO - 220	205
BDW94	BDW93	45	45	12	750	5.00	3.0	2.00	5.00	20	1.56	TO - 220	205
BDW94A	BDW93A	60	60	12	750	5.00	3.0	2.00	5.00	20	1.56	TO - 220	205
BDW94B	BDW93B	80	80	12	750	5.00	3.0	2.00	5.00	20	1.56	TO - 220	205
BDW94C	BDW93C	100	100	12	750	5.00	3.0	2.00	5.00	20	1.56	TO - 220	205
BDX33	BDX34	45	45	10	750	4.00	3.0	2.50	4.00	8	1.78	TO - 220	211
BDX33A	BDX34A	60	60	10	750	4.00	3.0	2.50	4.00	8	1.78	TO - 220	211
BDX33B	BDX34B	80	80	10	750	3.00	3.0	2.50	3.00	6	1.78	TO - 220	211
BDX33C	BDX34C	100	100	10	750	3.00	3.0	2.50	3.00	6	1.78	TO - 220	211
BDX34	BDX33	45	45	10	750	4.00	3.0	2.50	4.00	8	1.78	TO - 220	211
BDX34A	BDX33A	60	60	10	750	4.00	3.0	2.50	4.00	8	1.78	TO - 220	211
BDX34B	BDX33B	80	80	10	750	3.00	3.0	2.50	3.00	6	1.78	TO - 220	211
BDX34C	BDX33C	100	100	10	750	3.00	3.0	2.50	3.00	6	1.78	TO - 220	211
BDX53	BDX54	45	45	8	750	3.00	3.0	2.00	3.00	12	2.08	TO - 220	217
BDX53A	BDX54A	60	60	8	750	3.00	3.0	2.00	3.00	12	2.08	TO - 220	217

PNP Type in bold.

GENERAL PURPOSE TRANSISTORS (cont'd)

Type	Complementary	V _{CEO} (V)	V _{CBO} (V)	I _C (A)	h _{FE} @		V _{CE} (V)	V _{CEsat} (V)	I _C (A)	I _B (mA)	R _{thj-c} (°C/W)	Case	Page
					I _C (A)	V _{CE} (V)							
BDX53B	BDX54B	80	80	8	750	3.00	3.0	2.00	3.00	12	2.08	TO - 220	217
BDX53C	BDX54C	100	100	8	750	3.00	3.0	2.00	3.00	12	2.08	TO - 220	217
BDX53E	BDX54E	140	140	6	500	2.00	5.0	2.00	2.00	10	2.08	TO - 220	219
BDX53F	BDX54F	160	160	6	500	2.00	5.0	2.00	2.00	10	2.08	TO - 220	219
BDX53S	BDX54S	150	150	6	500	2.00	5.0	2.00	2.00	8	11.66	TO - 39	223
BDX54	BDX53	45	45	8	750	3.00	3.0	2.00	3.00	12	2.08	TO - 220	217
BDX54A	BDX53A	60	60	8	750	3.00	3.0	2.00	3.00	12	2.08	TO - 220	217
BDX54B	BDX53B	80	80	8	750	3.00	3.0	2.00	3.00	12	2.08	TO - 220	217
BDX54C	BDX53C	100	100	8	750	3.00	3.0	2.00	3.00	12	2.08	TO - 220	217
BDX54E	BDX53E	140	140	6	500	2.00	5.0	2.00	2.00	10	2.08	TO - 220	219
BDX54F	BDX53F	160	160	6	500	2.00	5.0	2.00	2.00	10	2.08	TO - 220	219
BDX54S	BDX53S	150	150	6	500	2.00	5.0	2.00	2.00	8	11.66	TO - 39	223
BDX85	BDX86	45	45	10	1000	3.00	3.0	2.00	4.00	16	1.75	TO - 3	227
BDX85A	BDX86A	60	60	10	1000	3.00	3.0	2.00	4.00	16	1.75	TO - 3	227
BDX85B	BDX86B	80	80	10	1000	3.00	3.0	2.00	4.00	16	1.75	TO - 3	227
BDX85C	BDX86C	100	100	10	1000	3.00	3.0	2.00	4.00	16	1.17	TO - 3	227
BDX86	BDX85	45	45	10	1000	3.00	3.0	2.00	4.00	16	1.75	TO - 3	227
BDX86A	BDX85A	60	60	10	1000	3.00	3.0	2.00	4.00	16	1.75	TO - 3	227
BDX86B	BDX85B	80	80	10	1000	3.00	3.0	2.00	4.00	16	1.75	TO - 3	227
BDX86C	BDX85C	100	100	10	1000	3.00	3.0	2.00	4.00	16	1.17	TO - 3	227
BDX87A	BDX88A	60	60	12	1000	5.00	3.0	2.00	6.00	24	1.75	TO - 3	223
BDX87B	BDX88B	80	80	12	1000	5.00	3.0	2.00	6.00	24	1.45	TO - 3	223
BDX87C	BDX88C	100	100	12	1000	5.00	3.0	2.00	6.00	24	1.45	TO - 3	223
BDX88A	BDX87A	60	60	12	1000	5.00	3.0	2.00	6.00	24	1.75	TO - 3	223
BDX88B	BDX87B	80	80	12	1000	5.00	3.0	2.00	6.00	24	1.45	TO - 3	223
BDX88C	BDX87C	100	100	12	1000	5.00	3.0	2.00	6.00	24	1.75	TO - 3	223
BFX34		60	100	5	40	2.00	2.0	1.00	5.00	500	35	TO - 39	243
BSS44		60	65	5	40	2.00	2.0	1.00	5.00	500	35	TO - 39	247
BU911		450	400	6	20	4.00	1.8	1.80	2.50	50	2.08	TO - 220	329
BU921		450	400	10	50	7.00	1.8	1.80	5.00	50	1.25	TO - 3	329
BU921P		450	400	10	50	7.00	1.8	1.80	5.00	50	1.2	TO - 218	329
BU921PFI		450	400	10	50	7.00	1.8	1.80	5.00	50	2.27	ISOWATT218	329
BU921T		450	400	10	50	7.00	1.8	1.80	5.00	50	1.2	TO - 220	329
BU921TFI		450	400	10	50	1.00	1.8	1.80	5.00	50	3.12	ISOWATT220	*
BU931R		450	400	15	300	5.00	10.0	1.60	7.00	70	1	TO - 3	337
BU931RP		450	400	15	300	5.00	10.0	1.60	7.00	70	1	TO - 218	337
BU931RPFI		450	400	15	300	5.00	10.0	1.60	7.00	70	2.08	ISOWATT218	337
BU931Z		350	350	15	80	8.00	1.8	1.60	7.00	70	1	TO - 3	343
BU931ZP		350	350	15	80	8.00	1.8	1.60	7.00	70	1	TO - 218	343
BU931ZPFI		350	350	15	80	8.00	1.8	1.60	7.00	70	2.08	ISOWATT218	343
BUY68		60	100	7	40	1.00	1.0	1.00	5.00	500	17.5	TO - 39	795
D44C1		30	40	4	10	1.00	1.0	0.50	1.00	100	4.2	TO - 220	801
D44C2		30	40	4	20	1.00	1.0	0.50	1.00	50	4.2	TO - 220	801
D44C3		30	40	4	20	2.00	1.0	0.50	1.00	50	4.2	TO - 220	801
D44C4		45	55	4	10	1.00	1.0	0.50	1.00	100	4.2	TO - 220	801

PNP Type in bold.

* Datasheet available on request

SELECTION GUIDE BY PART NUMBER

GENERAL PURPOSE TRANSISTORS (cont'd)

Type	Complementary	V _{CEO} (V)	V _{CBO} (V)	I _C (A)	h _{FE} @ I _C (A)	V _{CE} (V)	V _{CEsat} @ I _C (A)	I _B (mA)	R _{thj-c} (°C/W)	Case	Page		
D44C5		45	55	4	20	1.00	1.0	0.50	1.00	50	4.2	TO - 220	801
D44C6		45	55	4	20	2.00	1.0	0.50	1.00	50	4.2	TO - 220	801
D44C7		60	70	4	10	1.00	1.0	0.50	1.00	100	4.2	TO - 220	801
D44C8		60	70	4	20	1.00	1.0	0.50	1.00	50	4.2	TO - 220	801
D44C9		60	70	4	20	2.00	1.0	0.50	1.00	50	4.2	TO - 220	801
D44C10		80	90	4	10	1.00	1.0	0.50	1.00	100	4.2	TO - 220	801
D44C11		80	90	4	20	1.00	1.0	0.50	1.00	50	4.2	TO - 220	801
D44C12		80	90	4	20	2.00	1.0	0.50	1.00	50	4.2	TO - 220	801
D44H1	D45H1	30	30	10	20	4.00	1.0	1.00	8.00	800	2.5	TO - 220	803
D44H2	D45H2	30	30	10	40	4.00	1.0	1.00	8.00	400	2.5	TO - 220	803
D44H4	D45H4	45	45	10	20	4.00	1.0	1.00	8.00	800	2.5	TO - 220	803
D44H5	D45H5	45	45	10	40	4.00	1.0	1.00	8.00	400	2.5	TO - 220	803
D44H7	D45H7	60	60	10	20	4.00	1.0	1.00	8.00	800	2.5	TO - 220	803
D44H8	D45H8	60	60	10	40	4.00	1.0	1.00	8.00	400	2.5	TO - 220	803
D44H10	D45H10	80	80	10	20	4.00	1.0	1.00	8.00	800	2.5	TO - 220	803
D44H11		80	80	10	40	4.00	1.0	1.00	8.00	400	2.5	TO - 220	803
D45H1	D44H1	30	30	10	20	4.00	1.0	1.00	8.00	800	2.5	TO - 220	807
D45H2	D44H2	30	30	10	40	4.00	1.0	1.00	8.00	400	2.5	TO - 220	807
D45H4	D44H4	45	45	10	20	4.00	1.0	1.00	8.00	800	2.5	TO - 220	807
D45H5	D44H5	45	45	10	40	4.00	1.0	1.00	8.00	400	2.5	TO - 220	807
D45H7	D44H7	60	60	10	20	4.00	1.0	1.00	8.00	800	2.5	TO - 220	807
D45H8	D44H8	60	60	10	40	4.00	1.0	1.00	8.00	400	2.5	TO - 220	807
D45H10	D44H10	80	80	10	20	4.00	1.0	1.00	8.00	800	2.5	TO - 220	807
MJ802	MJ4502	90	100	30	25	7.50	2.0	0.80	7.50	750	0.875	TO - 3	809
MJ900	MJ1000	60	60	8	1000	3.00	3.0	2.00	3.00	12	1.94	TO - 3	815
MJ901	MJ1001	80	80	8	1000	3.00	3.0	2.00	3.00	12	1.94	TO - 3	815
MJ1000	MJ900	60	60	8	1000	3.00	3.0	2.00	3.00	12	1.94	TO - 3	815
MJ1001	MJ901	80	80	8	1000	3.00	3.0	2.00	3.00	12	1.94	TO - 3	815
MJ2500	MJ3000	60	60	10	1000	5.00	3.0	2.00	5.00	20	1.17	TO - 3	817
MJ2501	MJ3001	80	80	10	1000	5.00	3.0	2.00	5.00	20	1.17	TO - 3	817
MJ2955	2N3055	60	100	15	20	4.00	4.0	1.10	4.00	400	1.5	TO - 3	819
MJ3000	MJ2500	60	60	10	1000	5.00	3.0	2.00	5.00	20	1.17	TO - 3	817
MJ3001	MJ2501	80	80	10	1000	5.00	3.0	2.00	5.00	20	1.17	TO - 3	817
MJ4030	MJ4033	60	60	16	1000	10.00	3.0	4.00	16.00	80	1.17	TO - 3	821
MJ4031	MJ4034	80	80	16	1000	10.00	3.0	4.00	16.00	80	1.17	TO - 3	821
MJ4032	MJ4035	100	100	16	1000	10.00	3.0	4.00	16.00	80	1.17	TO - 3	821
MJ4033	MJ4030	60	60	16	1000	10.00	3.0	4.00	16.00	80	1.17	TO - 3	821
MJ4034	MJ4031	80	80	16	1000	10.00	3.0	4.00	16.00	80	1.17	TO - 3	821
MJ4035	MJ4032	100	100	16	1000	10.00	3.0	4.00	16.00	80	1.17	TO - 3	821
MJ4502	MJ802	90	100	30	25	7.50	2.0	0.80	7.50	750	0.875	TO - 3	809
MJ11011	MJ11012	60	60	30	1000	20.00	5.0	4.00	30.00	300	0.875	TO - 3	825
MJ11012	MJ11011	60	60	30	1000	20.00	5.0	4.00	30.00	300	0.875	TO - 3	825
MJ11013	MJ11014	90	90	30	1000	20.00	5.0	4.00	30.00	300	0.875	TO - 3	825
MJ11014	MJ11013	90	90	30	1000	20.00	5.0	4.00	30.00	300	0.875	TO - 3	825
MJ11015	MJ11016	120	120	30	1000	20.00	5.0	4.00	30.00	300	0.875	TO - 3	825

PNP Type in bold.

GENERAL PURPOSE TRANSISTORS (cont'd)

Type	Complementary	V _{CEO} (V)	V _{CB0} (V)	I _C (A)	h _{FE} @ I _C (A)	V _{CE} (V)	V _{CEsat} (V)	I _C (A)	I _B (mA)	R _{thj-c} (°C/W)	Case	Page	
MJ11016	MJ11015	120	120	30	1000	20.00	5.0	4.00	30.00	300	0.875	TO - 3	825
MJE170	MJE180	40	60	3	30	0.50	1.0	0.90	1.50	150	10	SOT - 32	829
MJE171	MJE181	60	80	3	30	0.50	1.0	0.90	1.50	150	10	SOT - 32	829
MJE172	MJE182	80	100	3	30	0.50	1.0	0.90	1.50	150	10	SOT - 32	829
MJE180	MJE170	40	60	3	30	0.50	1.0	0.90	1.50	150	10	SOT - 32	829
MJE181	MJE171	60	80	3	30	0.50	1.0	0.90	1.50	150	10	SOT - 32	829
MJE182	MJE172	80	100	3	30	0.50	1.0	0.90	1.50	150	10	SOT - 32	829
MJE200	MJE210	25	40	5	70	0.50	1.0	0.30	0.50	50	8.34	SOT - 32	833
MJE210	MJE200	25	40	5	70	0.50	1.0	0.30	0.50	50	8.34	SOT - 32	833
MJE370	MJE520	30	30	3	25	1.00	1.0				5	SOT - 32	841
MJE371	MJE521	40	40	4	40	1.00	1.0				3.12	SOT - 32	845
MJE520	MJE370	30	30	3	25	1.00	1.0				5	SOT - 32	841
MJE521	MJE371	40	40	4	40	1.00	1.0				3.12	SOT - 32	845
MJE700	MJE800	60	60	4	750	1.50	3.0	3.00	4.00	40	3.12	SOT - 32	849
MJE701	MJE801	60	60	4	750	2.00	3.0	3.00	4.00	40	3.12	SOT - 32	849
MJE702	MJE802	80	80	4	750	1.50	3.0	3.00	4.00	40	3.12	SOT - 32	849
MJE703	MJE803	80	80	4	750	2.00	3.0	3.00	4.00	40	3.12	SOT - 32	849
MJE800	MJE700	60	60	4	750	1.50	3.0	3.00	4.00	40	3.12	SOT - 32	849
MJE801	MJE701	60	60	4	750	2.00	3.0	3.00	4.00	40	3.12	SOT - 32	849
MJE802	MJE702	80	80	4	750	1.50	3.0	3.00	4.00	40	3.12	SOT - 32	849
MJE803	MJE703	80	80	4	750	2.00	3.0	3.00	4.00	40	3.12	SOT - 32	849
MJE2955T	MJE3055T	60	70	10	20	4.00	4.0	1.10	4.00	400	1.66	TO - 220	853
MJE3055T	MJE2955T	60	70	10	20	4.00	4.0	1.10	4.00	400	1.66	TO - 220	853
SGS110	SGS115	60	60	4	1000	1.00	4.0	2.50	2.00	8	2.5	SOT - 82	1017
SGS111	SGS116	80	80	4	1000	1.00	4.0	2.50	2.00	8	2.5	SOT - 82	1017
SGS112	SGS117	100	100	4	1000	1.00	4.0	2.50	2.00	8	2.5	SOT - 82	1017
SGS115	SGS110	60	60	4	1000	1.00	4.0	2.50	2.00	8	2.5	SOT - 82	1017
SGS116	SGS111	80	80	4	1000	1.00	4.0	2.50	2.00	8	2.5	SOT - 82	1017
SGS117	SGS112	100	100	4	1000	1.00	4.0	2.50	2.00	8	2.5	SOT - 82	1017
SGS130	SGS135	60	60	8	1000	4.00	4.0	2.00	4.00	16	1.78	SOT - 82	1029
SGS131	SGS136	80	80	8	1000	4.00	4.0	2.00	4.00	16	1.78	SOT - 82	1029
SGS132	SGS137	100	100	8	1000	4.00	4.0	2.00	4.00	16	1.78	SOT - 82	1029
SGS135	SGS130	60	60	8	1000	4.00	4.0	2.00	4.00	16	1.78	SOT - 82	1029
SGS136	SGS131	80	80	8	1000	4.00	4.0	2.00	4.00	16	1.78	SOT - 82	1029
SGS137	SGS132	100	100	8	1000	4.00	4.0	2.00	4.00	16	1.78	SOT - 82	1029
SGSD100	SGSD200	80	80	25	300	20.00	3.0	1.75	10.00	40	0.96	TO - 218	885
SGSD200	SGSD100	80	80	25	300	20.00	3.0	1.75	10.00	40	0.96	TO - 218	885
SGSD93E		140	160	12	1000	3.00	3.0	2.00	10.00	20	1.56	TO - 220	881
SGSD93F		160	180	12	1000	3.00	3.0	2.00	10.00	20	1.56	TO - 220	881
SGSD93FFI		160	180	12	1000	3.00	3.0	2.00	10.00	20	4.16	ISOWATT220	*
SGSD93G		180	200	12	1000	3.00	3.0	2.00	10.00	20	1.56	TO - 220	881
TIP31	TIP32	40	80	3	25	1.00	4.0	1.20	3.00	375	3.12	TO - 220	995
TIP31A	TIP32A	60	100	3	25	1.00	4.0	1.20	3.00	375	3.12	TO - 220	995
TIP31B	TIP32B	80	120	3	25	1.00	4.0	1.20	3.00	375	3.12	TO - 220	995
TIP31C	TIP32C	100	140	3	25	1.00	4.0	1.20	3.00	375	3.12	TO - 220	995

PNP Type in bold.

* Datasheet available on request

SELECTION GUIDE BY PART NUMBER

GENERAL PURPOSE TRANSISTORS (cont'd)

Type	Complementary	V _{CE0} (V)	V _{CB0} (V)	I _C (A)	h _{FE} @ I _C (A)	V _{CE} (V)	V _{CEsat} @ (V)	I _C (A)	I _B (mA)	R _{thj-c} (°C/W)	Case	Page	
TIP32	TIP31	40	80	3	25	1.00	4.0	1.20	3.00	3.12	TO - 220	995	
TIP32A	TIP31A	60	100	3	25	1.00	4.0	1.20	3.00	3.12	TO - 220	995	
TIP32B	TIP31B	80	120	3	25	1.00	4.0	1.20	3.00	3.12	TO - 220	985	
TIP32C	TIP31C	100	140	3	25	1.00	4.0	1.20	3.00	3.12	TO - 220	995	
TIP33A	TIP34A	60	100	10	20	3.00	4.0	1.00	3.00	1.39	TO - 218	999	
TIP33B	TIP34B	80	120	10	20	3.00	4.0	1.00	3.00	1.39	TO - 218	999	
TIP33C	TIP34C	100	140	10	20	3.00	4.0	1.00	3.00	1.39	TO - 218	999	
TIP34A	TIP33A	60	100	10	20	3.00	4.0	1.00	3.00	1.39	TO - 218	999	
TIP34B	TIP33B	80	120	10	20	3.00	4.0	1.00	3.00	1.39	TO - 218	999	
TIP34C	TIP33C	100	140	10	20	3.00	4.0	1.00	3.00	1.39	TO - 218	999	
TIP35A	TIP36A	60	100	25	10	15.00	4.0	1.80	15.00	1	TO - 218	1001	
TIP35B	TIP36B	80	120	25	10	15.00	4.0	1.80	15.00	1	TO - 218	1001	
TIP35C	TIP36C	100	140	25	10	15.00	4.0	1.80	15.00	1	TO - 218	1001	
TIP36A	TIP35A	60	100	25	10	15.00	4.0	1.80	15.00	1	TO - 218	1001	
TIP36B	TIP35B	80	120	25	10	15.00	4.0	1.80	15.00	1	TO - 218	1001	
TIP36C	TIP35C	100	140	25	10	15.00	4.0	1.80	15.00	1	TO - 218	1001	
TIP41	TIP42	40	80	6	15	3.00	4.0	1.50	6.00	600	1.92	TO - 220	1003
TIP41A	TIP42A	60	100	6	15	3.00	4.0	1.50	6.00	600	1.92	TO - 220	1003
TIP41B	TIP42B	80	120	6	15	3.00	4.0	1.50	6.00	600	1.92	TO - 220	1003
TIP41C	TIP42C	100	140	6	15	3.00	4.0	1.50	6.00	600	1.92	TO - 220	1003
TIP42	TIP41	40	80	6	15	3.00	4.0	1.50	6.00	600	1.92	TO - 220	1003
TIP42A	TIP41A	60	100	6	15	3.00	4.0	1.50	6.00	600	1.92	TO - 220	1003
TIP42B	TIP41B	80	120	6	15	3.00	4.0	1.50	6.00	600	1.92	TO - 220	1003
TIP42C	TIP41C	100	140	6	15	3.00	4.0	1.50	6.00	600	1.92	TO - 220	1003
TIP100	TIP105	60	60	8	1000	3.00	4.0	2.00	3.00	6	1.56	TO - 220	1011
TIP101	TIP106	80	80	8	1000	3.00	4.0	2.00	3.00	6	1.56	TO - 220	1011
TIP102	TIP107	100	100	8	1000	3.00	4.0	2.00	3.00	6	1.56	TO - 220	1011
TIP105	TIP100	60	60	8	1000	3.00	4.0	2.00	3.00	6	1.56	TO - 220	1011
TIP106	TIP101	80	80	8	1000	3.00	4.0	2.00	3.00	6	1.56	TO - 220	1011
TIP107	TIP102	100	100	8	1000	3.00	4.0	2.00	3.00	6	1.56	TO - 220	1011
TIP110	TIP115	60	60	4	1000	1.00	4.0	2.50	2.00	8	2.5	TO - 220	1017
TIP111	TIP116	80	80	4	1000	1.00	4.0	2.50	2.00	8	2.5	TO - 220	1017
TIP112	TIP117	100	100	4	1000	1.00	4.0	2.50	2.00	8	2.5	TO - 220	1017
TIP115	TIP110	60	60	4	1000	1.00	4.0	2.50	2.00	8	2.5	TO - 220	1017
TIP116	TIP111	80	80	4	1000	1.00	4.0	2.50	2.00	8	2.5	TO - 220	1017
TIP117	TIP112	100	100	4	1000	1.00	4.0	2.50	2.00	8	2.5	TO - 220	1017
TIP120	TIP125	60	60	5	1000	3.00	3.0	2.00	3.00	12	1.92	TO - 220	1023
TIP121	TIP126	80	80	5	1000	3.00	3.0	2.00	3.00	12	1.92	TO - 220	1023
TIP122	TIP127	100	100	5	1000	3.00	3.0	2.00	3.00	12	1.92	TO - 220	1023
TIP125	TIP120	60	60	5	1000	3.00	3.0	2.00	3.00	12	1.92	TO - 220	1023
TIP126	TIP121	80	80	5	1000	3.00	3.0	2.00	3.00	12	1.92	TO - 220	1023
TIP127	TIP122	100	100	5	1000	3.00	3.0	2.00	3.00	12	1.92	TO - 220	1023
TIP130	TIP135	60	60	8	1000	4.00	4.0	2.00	4.00	16	1.78	TO - 220	1029
TIP131	TIP136	80	80	8	1000	4.00	4.0	2.00	4.00	16	1.78	TO - 220	1029
TIP132	TIP137	100	100	8	1000	4.00	4.0	2.00	4.00	16	1.78	TO - 220	1029

PNP Type in bold.

GENERAL PURPOSE TRANSISTORS (cont'd)

Type	Complementary	V _{CE0} (V)	V _{CB0} (V)	I _C (A)	h _{FE} @ I _C (A)	V _{CE} (V)	V _{CEsat} @ I _C (V)	I _C (A)	I _B (mA)	R _{thj-c} (°C/W)	Case	Page	
TIP135	TIP130	60	60	8	1000	4.00	4.0	2.00	4.00	16	1.78	TO - 220	1029
TIP136	TIP131	80	80	8	1000	4.00	4.0	2.00	4.00	16	1.78	TO - 220	1029
TIP137	TIP132	100	100	8	1000	4.00	4.0	2.00	4.00	16	1.78	TO - 220	1029
TIP140	TIP145	60	60	10	1000	5.00	4.0	3.00	10.00	40	1	TO - 218	1031
TIP140T	TIP145T	60	60	15	1000	5.00	4.0	3.00	10.00	40	1.25	TO - 220	1035
TIP141	TIP146	80	80	10	1000	5.00	4.0	3.00	10.00	40	1	TO - 218	1031
TIP141T	TIP146T	80	80	15	1000	5.00	4.0	3.00	10.00	40	1.25	TO - 220	1035
TIP142	TIP147	100	100	10	1000	5.00	4.0	3.00	10.00	40	1	TO - 218	1031
TIP142T	TIP147T	100	100	15	1000	5.00	4.0	3.00	10.00	40	1.25	TO - 220	1035
TIP145	TIP140	60	60	10	1000	5.00	4.0	3.00	10.00	40	1	TO - 218	1031
TIP145T	TIP140T	60	60	15	1000	5.00	4.0	3.00	10.00	40	1.25	TO - 220	1035
TIP146	TIP141	80	80	10	1000	5.00	4.0	3.00	10.00	40	1	TO - 218	1031
TIP146T	TIP141T	80	80	15	1000	5.00	4.0	3.00	10.00	40	1.25	TO - 220	1035
TIP147	TIP142	100	100	10	1000	5.00	4.0	3.00	10.00	40	1	TO - 218	1031
TIP147T	TIP142T	100	100	15	1000	5.00	4.0	3.00	10.00	40	1.25	TO - 220	1035
TIP2955	TIP3055	60	100	15	20	4.00	4.0	1.10	4.00	400	1.39	TO - 218	1037
TIP3055	TIP2955	60	100	15	20	4.00	4.0	1.10	4.00	400	1.39	TO - 218	1037

PNP Type in bold.

SWITCHING TRANSISTORS

Type	Complementary	V _{CBO} (V)	V _{CEO} (V)	I _C (A)	V _{CEsat} @ I _C (V)	I _B (mA)	t _s (μs)	t _f (μs)	R _{thj-c} (°C/W)	Case	Page
2N3439		450	350	1	0.50	0.05	4		17.5	TO - 39	1043
2N3440		300	250	1	0.50	0.05	4		17.5	TO - 39	1043
2N4895		120	60	5	1.00	5.00	500	0.35	0.3	TO - 39	1059
2N4896		120	60	5	1.00	5.00	500	0.35	0.3	TO - 39	1059
2N4897		150	80	5	1.00	5.00	500	0.35	0.3	TO - 39	1059
2N5038		150	90	20	1.00	12.00	1200	1.5	0.5	TO - 3	1067
2N5039		120	75	20	1.00	10.00	1000	1.5	0.5	TO - 3	1067
2N5415		200	200	1	2.50	0.05	5	0.3	0.2	TO - 39	1093
2N5416		350	300	1	2.50	0.05	5	0.3	0.2	TO - 39	1093
2N5655		275	250	0.5	1.00	0.10	10		6.25	SOT - 32	1103
2N5656		325	300	0.5	1.00	0.10	10		6.25	SOT - 32	1103
2N5657		375	350	0.5	1.00	0.10	10		6.25	SOT - 32	1103
2N5671		120	90	30	0.75	15.00	1200	1.5	0.5	TO - 3	1107
2N5672		150	120	30	0.75	15.00	1200	1.5	0.5	TO - 3	1107
2N6032		120	90	50	1.30	50.00	5000	1.5	0.5	TO - 3	1127
2N6033		150	120	40	1.00	40.00	4000	1.5	0.5	TO - 3	1127
2N6497		350	250	5	1.00	2.50	500	1.8	0.8	TO - 220	1159
2N6498		400	300	5	1.25	2.50	500	1.8	0.8	TO - 220	1158
2N6499		450	350	5	1.50	2.50	500	1.8	0.8	TO - 220	1159
2N6544		650	300	8	1.5	5.00	1000	4	0.9	TO - 3	1163
2N6545		850	400	8	1.5	5.00	1000	4	0.9	TO - 3	1163
2N6671		450	300	8	1.00	5.00	1000	2.5	0.4	TO - 3	1167
2N6672		550	350	8	1.00	5.00	1000	2.5	0.4	TO - 3	1167
2N6673		650	400	8	1.00	5.00	1000	2.5	0.4	TO - 3	1167
2N6674		450	300	15	1.00	10.00	2000	2.5	0.5	TO - 3	1171
2N6675		650	400	15	1.00	10.00	2000	2.5	0.5	TO - 3	1171
2N6676		450	300	15	1.00	15.00	3000	2.5	0.5	TO - 3	1175
2N6677		550	350	15	1.00	15.00	3000	2.5	0.5	TO - 3	1175
2N6678		650	400	15	1.00	15.00	3000	2.5	0.5	TO - 3	1175
2N6702		140	90	7	0.80	5.00	500	1	0.5	TO - 220	1179
2N6928		450	300	8	1.00	8.00	1600	2.5	0.4	TO - 220	*
2N6929		550	350	8	1.00	8.00	1600	2.5	0.4	TO - 220	*
2N6930		650	400	8	1.00	8.00	1600	2.5	0.4	TO - 220	*
2N6931		450	300	10	1.00	10.00	2000	2.5	0.5	SOT - 93	1181
2N6932		650	400	10	1.00	10.00	2000	2.5	0.5	SOT - 93	1181
2N6933		450	300	15	1.00	15.00	3000	2.5	0.5	SOT - 93	1185
2N6934		550	350	15	1.00	15.00	3000	2.5	0.5	SOT - 93	1185
2N6935		650	400	15	1.00	15.00	3000	2.5	0.5	SOT - 93	1185
2SC3412		1300	500	8	5.0	5.00	1000			TO - 3	*
2SD818		1500	600	2.5	8.0	2.00	600			TO - 3	*
2SD819		1500	600	3.5	8.0	3.00	800			TO - 3	*
2SD869		1500	600	3.5	8.0	3.00	800			TO - 3	*
2SD1425FI		1500	600	2.5	8.0	2.00	600			ISOWATT218	*
2SD1426FI		1500	600	3.5	8.0	3.00	800			ISOWATT218	*
2SD1427FI		1500	600	5	5.0	4.00	800			ISOWATT218	*

PNP Type in bold.

* Datasheet available on request

SWITCHING TRANSISTORS (cont'd)

Type	Complementary	V _{CB0} (V)	V _{CEO} (V)	I _C (A)	V _{CEsat} @ (V)	I _C (A)	I _B (mA)	t _s (μs)	t _f (μs)	R _{thj-c} (°C/W)	Case	Page
2SD1428FI		1500	600	6	5.0	5.00	1000				ISOWATT218	*
2SD1429FI		1500	600	2.5	8.0	2.00	600				ISOWATT218	*
2SD1430FI		1500	600	3.5	8.0	3.00	800				ISOWATT218	*
2SD1431FI		1500	600	5	5.0	4.00	800				ISOWATT218	*
2SD1432FI		1500	600	6	5.0	5.00	1000				ISOWATT218	*
2SD1441		1500	700	4	1.0	3.00	1000				TO - 218	*
2SD1453		1500	700	3	5.0	2.50	800				TO - 218	*
2SD1455		1500	700	5	5.0	4.50	1200				TO - 218	*
2SD1577FI		1500	700	5	2.0	4.50	2000				ISOWATT218	*
2SD1650FI		1500	700	3.5	8.0	2.50	800				ISOWATT218	*
2SD1730		1500	700	5	8.0	4.00	1000				TO - 218	*
2SD1910FI		1500	700	3	5.0	2.50	800				ISOWATT218	*
2ST1396		1500	700	2.5	8.0	2.00	600				TO - 218	*
2ST1651FI		1500	700	5	5.0	4.00	800				ISOWATT218	*
2ST1877FI		1500	700	4	5.0	2.50	800				ISOWATT218	*
2ST1942		1500	700	3	5.0	2.50	800				TO - 3	*
2ST2000		1500	700	7.5	1.0	4.00	2000				TO - 218	*
2ST2000FI		1500	700	7	1.0	4.00	2000				ISOWATT218	*
2ST3153		1000	550	6	2.0	3.00	600				TO - 218	*
2ST3412		1200	600	8	5.0	5.00	1000				TO - 3	*
2ST3460		1500	700	6	2.0	3.00	600				TO - 218	*
2ST3461		1500	700	8	2.0	4.00	800				TO - 218	*
2ST3485		1500	700	5	5.0	4.00	1000				TO - 218	*
2ST3485FI		1500	700	5	5.0	4.00	1000				ISOWATT218	*
2ST3552		1200	600	12	2.0	6.00	1200				TO - 218	*
2ST3642		1200	600	6	5.0	4.00	800				TO - 218	*
2ST3679FI		1000	500	5	0.5	2.00	400				ISOWATT218	*
BD157		275	250	0.5						6.25	SOT - 32	141
BD158		325	300	0.5						6.25	SOT - 32	141
BD159		375	350	0.5						6.25	SOT - 32	141
BDY57		120	80	25	1.40	10.00	1000	1.5	0.5	1	TO - 3	239
BDY58		160	125	25	1.40	10.00	1000	1.5	0.5	1	TO - 3	239
BDY90		100	120	10	0.50	5.00	500	1.3	0.2	2.5	TO - 3	241
BDY91		80	100	10	0.50	5.00	500	1.3	0.2	2.5	TO - 3	241
BDY92		60	80	10	0.50	5.00	500	1.3	0.2	2.5	TO - 3	241
BSW67		120	120	1.5	1.00	1.00	150	0.7●	0.22●	35	TO - 39	251
BSW68		150	150	1.5	1.00	1.00	150	0.7●	0.22●	35	TO - 39	251
BU125		130	60	6	1.00	5.00	500			15	TO - 39	255
BU125S		250	150	3	1.50	0.50	50			17.5	TO - 39	259
BU184		400	200	8	1.50	5.00	50	0.5	0.44●	2.08	TO - 220	263
BU189		330	150	8	1.50	5.00	50	0.5	0.44●	2.08	TO - 220	263
BU208		1500	700	8	5.0	4.50	2000	7●	0.55●	1	TO - 3	267
BU208A		1500	700	8	1.0	4.50	2000	7●	0.55●	1	TO - 3	267
BU208D		1500	700	8	1.0	4.50	2000	7●	0.55●	1	TO - 3	271
BU325		200	200	3	1.50	0.50	50	0.75●	0.20●	5	SOT - 32	277

● Typical value

* Datasheet available on request

SWITCHING TRANSISTORS (cont'd)

Type	Complementary	V _{CE0} (V)	V _{CE0} (V)	I _C (A)	V _{CEsat} (V) @	I _C (A)	I _B (mA)	t _s (μs)	t _f (μs)	R _{thj-c} (°C/W)	Case	Page
BU326A		900	400	6	1.5	2.50	500	3.5	0.5	2.33	TO - 3	281
BU406		400	200	7	1.00	5.00	500	0.9●	0.3●	2.08	TO - 220	285
BU406D		400	200	7	1.00	5.00	650	0.9●	0.3●	2.08	TO - 220	291
BU407		330	150	7	1.00	5.00	500	0.9●	0.3●	2.08	TO - 220	297
BU407D		330	150	7	1.00	5.00	650	0.9●	0.3●	2.08	TO - 220	291
BU426		800	375	6	1.5	2.50	500	3.5	0.5	1.16	TO - 218	303
BU426A		900	400	6	1.5	2.50	500	3.5	0.5	1.1	TO - 218	303
BU426AFI		900	400	6	1.5	2.50	500	3.5	0.5	2.5	ISOWATT218	303
BU426FI		800	375	6	1.5	2.50	500	3.5	0.5	2.5	ISOWATT218	303
BU508		1500	700	8	5.0	4.50	2000	7●	0.55●	1	TO - 218	267
BU508A		1500	700	8	1.0	4.50	2000	7●	0.55●	1	TO - 218	267
BU508AFI		1500	700	8	1.0	4.50	2000	7●	0.55●	2.08	ISOWATT218	267
BU508D		1500	700	8	1.0	4.50	2000	7●	0.55●	1	TO - 218	271
BU508DFI		1500	700	8	1.0	4.50	2000	7●	0.55●	2.08	ISOWATT218	271
BU508FI		1500	700	8	5.0	4.50	2000	7●	0.55●	2.08	ISOWATT218	267
BU706		1500	700	5	5.0	3.00	1330				TO - 218	305
BU801		600	400	3	2.20	1.00	15	1	0.5	3.12	SOT - 32	307
BU806		400	200	8	1.50	5.00	50	0.55●	0.2●	2.08	TO - 220	311
BU806FI		400	200	8	1.50	5.00	50	0.55●	0.22●	4.16	ISOWATT220	311
BU807		330	150	8	1.50	5.00	50	0.55●	0.2●	2.08	TO - 220	311
BU807FI		330	150	8	1.50	5.00	50	0.55●	0.2●	2.08	ISOWATT220	311
BU808FI		1400	700	10	1.6	5.00	500			2.5	ISOWATT218	317
BU808TFI		1400	700	10	1.6	5.00	500			2.5	ISOWATT218	317
BU810		600	400	7	2.50	4.00	200	1.5	0.5	1.66	TO - 220	321
BU999		160	140	25	0.80	10.00	1000	1.5	0.25	1.17	TO - 218	347
BUF405		850	450	7.5	0.5●	5.00	1000			1.56	TO - 220	349
BUF405A		1000	450	7.5	0.5●	5.00	1000			1.56	TO - 220	349
BUF410		850	450	15	0.5●	10.00	2000			1	TO - 218	353
BUF410A		1000	450	15	0.5●	10.00	2000			1	TO - 218	353
BUF410AI		1000	450	15	0.5●	10.00	2000			1.47	TOP - 3I	353
BUF410I		850	450	15	0.5●	10.00	2000			1.47	TOP - 3I	353
BUF420		850	450	30	0.5●	20.00	4000			0.63	TO - 218	357
BUF420A		1000	450	30	0.5●	20.00	4000			0.63	TO - 218	357
BUF420AI		1000	450	30	0.5●	20.00	4000			1.09	TOP - 3I	357
BUF420AM		1000	450	30	0.5●	20.00	4000			0.63	TO - 3	357
BUF420M		850	450	30	0.5●	20.00	4000			0.63	TO - 3	357
BUF420I		850	450	30	0.5●	20.00	4000			1.09	TOP - 3I	357
BUF460(V)		850	450	90	2.0#	60	12000	3.5▲■	0.12▲■	0.41	ISOTOP	*
BUF460A(V)		1000	450	90	2.0#	60	12000	3.5▲■	0.12▲■	0.41	ISOTOP	*
BUR20		200	125	50	1.00	25.00	2000			0.7	TO - 3	361
BUR21		300	200	40	0.60	12.00	1200				TO - 3	363
BUR22		350	250	40	1.00	10.00	1000				TO - 3	365
BUR50		200	125	70	1.00	35.00	2000	2	0.5	0.5	TO - 3	367
BUR50S		200	125	70	1.00	35.00	2000	2	0.5	0.5	TO - 3	367
BUR51		300	200	60	1.00	35.00	2000	2	0.6	0.5	TO - 3	371

▲ Inductive load

● Typical value

T_J = 125°C

■ T_J = 100°C

* Datasheet available on request

SWITCHING TRANSISTORS (cont'd)

Type	Complementary	V _{CEO} (V)	V _{CE0} (V)	I _C (A)	V _{CEsat} (V)	I _C (A)	I _B (mA)	t _s (μs)	t _f (μs)	R _{thj-c} (°C/W)	Case	Page
BUR52		350	250	60	1.80	25.00	2000	2	0.6	0.5	TO - 3	375
BUT11		850	400	5	1.5	3.00	600	4	0.8	1.5	TO - 220	379
BUT11A		1000	450	5	1.5	2.50	500	4	0.8	1.5	TO - 220	379
BUT11AFI		1000	450	5	1.5	2.50	500	4	0.8	3.57	ISOWATT220	379
BUT11FI		850	400	5	1.5	3.00	600	4	0.8	3.57	ISOWATT220	379
BUT12AFI		1000	450	10	1.5	5.00	1000				ISOWATT220	*
BUT12FI		850	400	10	1.5	6.00	1200				ISOWATT220	*
BUT13		600	400	28	2.00	10.00	500	1.5	0.6	1	TO - 3	385
BUT13P		600	400	28	2.00	10.00	500	1.5	0.6	1	TO - 218	385
BUT13PFI		600	400	28	2.00	10.00	500	1.5	0.6	2.08	ISOWATT218	385
BUT30(V)		200	125	100	0.9	100	10000	2▲	0.2▲	0.5	ISOTOP	*
BUT32(V)		400	300	80	0.9	40	4000	3▲	0.4▲	0.5	ISOTOP	*
BUT60		200	125	16	0.90	12.00	600	1.5▲	0.2▲	1	TO - 220	*
BUT62		400	300	16	0.90	10.00	1000	2.2▲	0.4▲	1	TO - 220	*
BUT70		200	125	40	0.90	35.00	1750	1.8▲	0.2▲	0.63	TO - 218	*
BUT72		400	300	40	0.90	30.00	3000	3▲	0.4▲	0.63	TO - 218	*
BUT90		200	125	50	0.90	35.00	1750	1.5	0.4	0.7	TO - 3	391
BUT91		300	200	50	1.20	40.00	4000	1.2	0.3	0.7	TO - 3	397
BUT92		350	250	50	1.20	35.00	3500	3▲	0.4▲	0.7	TO - 3	405
BUT92A		400	300	50	0.90	30.00	3000	3▲	0.4▲	0.7	TO - 3	411
BUT100		200	125	50	0.90	50.00	2500	2▲	0.2▲	0.58	TO - 3	417
BUT102		400	300	50	0.90	40.00	4000	3▲	0.4▲	0.7	TO - 3	421
BUT230(V)		200	125	200	0.9	200	20000	2▲	0.2▲	0.41	ISOTOP	*
BUV18		60	120	50	0.60	40.00	4000	1.1	0.3	0.7	TO - 3	425
BUV19		80	160	50	0.60	30.00	3000	1.1	0.25	0.7	TO - 3	425
BUV20		160	125	50	0.60	25.00	2500	1.2	0.25	0.7	TO - 3	433
BUV21		250	200	40	0.60	12.00	1200	1.8	0.4	0.7	TO - 3	433
BUV22		300	250	40	1.00	10.00	1000	2	0.5	0.7	TO - 3	433
BUV23		400	325	30	1.00	16.00	3200	2.5	1.2		TO - 3	437
BUV24		450	400	20	1.00	12.00	2400	3	1.4	0.7	TO - 3	437
BUV25		500	500	15	1.00	8.00	1600	5	1.6	0.7	TO - 3	437
BUV26		180	90	14	0.60	6.00	600	1	0.25	1.76	TO - 220	441
BUV27		240	120	12	0.70	4.00	400	1.2	0.25	1.76	TO - 220	447
BUV28		400	200	10	1.50	6.00	600	1.5	0.25	1.76	TO - 220	453
BUV39		160	90	25	1.20	20.00	2500	1	0.25	1.46	TO - 3	459
BUV40		250	125	20	0.90	11.00	1100	1	0.3	1.46	TO - 3	467
BUV41		300	200	15	0.90	6.00	600	1.2	0.3	1.46	TO - 3	475
BUV42		350	250	12	0.90	4.00	400	1.6	0.3	1.46	TO - 3	483
BUV42A		400	300	12	0.90	4.00	400	3▲	0.4▲	1.46	TO - 3	491
BUV46		850	400	5	1.5	2.50	500	3	0.8	1.76	TO - 220	495
BUV46A		1000	450	5	1.5	2.00	400	3	0.8	1.76	TO - 220	495
BUV46AFI		1000	450	5	1.5	2.00	400				ISOWATT220	495
BUV46FI		850	400	5	1.5	2.50	500	3	0.8	4.16	ISOWATT220	495
BUV47		850	400	9	1.5	6.00	1200	2.5	0.8	1.25	TO - 218	735
BUV47A		1000	450	9	1.5	5.00	1000	3	0.8	1.25	TO - 218	735

▲ Inductive load

■ T_j = 100°C

* Datasheet available on request

SELECTION GUIDE BY PART NUMBER

SWITCHING TRANSISTORS (cont'd)

Type	Complementary	V _{CEO} (V)	V _{CE0} (V)	I _C (A)	V _{CEsat} @ I _C (V)	I _C (A)	I _B (mA)	t _s (μs)	t _f (μs)	R _{thj-c} (°C/W)	Case	Page
BUV47AFI		1000	450	9	1.5	5.00	1000	3	0.8	2.27	ISOWATT218	735
BUV47FI		850	400	9	1.5	6.00	1200	2.5	0.8	2.27	ISOWATT218	735
BUV48		850	400	15	1.5	10.00	2000	3	0.8	1	TO - 218	745
BUV48A		1000	450	15	1.5	8.00	1600	3	0.8	1	TO - 218	745
BUV48AFI		1000	450	15	1.5	8.00	1600	3	0.8	1.92	ISOWATT218	745
BUV48B		1200	600	15	1.5	6.00	1500	3	0.7	1	TO - 218	755
BUV48BFI		1200	600	15	1.5	6.00	1500	3	0.7	1.92	ISOWATT218	755
BUV48C		1200	700	15	1.5	6.00	1500	3	0.7	1	TO - 218	755
BUV48CFI		1200	700	15	1.5	6.00	1500	3	0.7	1.92	ISOWATT218	745
BUV48FI		850	400	15	1.5	10.00	2000	3	0.8	1.92	ISOWATT218	745
BUV50		250	125	25	0.90	20.00	2000	1.2	0.3	1.17	TO - 3	497
BUV51		300	200	20	0.90	10.00	1000	1.4	0.3	1.17	TO - 3	505
BUV52		350	250	20	0.90	8.00	800	1.6	0.3	1.17	TO - 3	513
BUV52A		400	300	20	0.90	7.00	700	3▲	0.4▲	1.17	TO - 3	521
BUV56		850	450	9	1.2	5.00	1000	3▲	0.4▲	1.76	TO - 220	525
BUV60		250	125	50	0.90	50.00	5000	1.1	0.2	0.7	TO - 3	529
BUV61		300	200	50	0.90	25.00	2500	1.2	0.3	0.7	TO - 3	537
BUV62		350	250	40	0.90	16.00	1600	1.8	0.35	0.7	TO - 3	545
BUV62A		400	300	40	0.90	15.00	1500	3▲	0.4▲	0.7	TO - 3	553
BUV66		850	450	15	1.2	8.00	1600	3▲	0.4▲	1.25	TO - 220	557
BUV98(V)		850	450	30	1.5	20	4000	5▲■	0.4▲■	0.83	ISOTOP	*
BUV98A(V)		1000	450	30	1.5	16	3200	5▲■	0.4▲■	0.83	ISOTOP	*
BUV98C(V)		1200	700	30	1.5	12	3000	6▲#	0.6▲#	0.83	ISOTOP	*
BUV298(V)		850	450	60	1.2	40	8000	4.5▲■	0.4▲■	0.5	ISOTOP	*
BUV298A(V)		1000	450	50	1.2	32	6400	4.5▲■	0.4▲■	0.5	ISOTOP	*
BUW12		850	400	8	1.5	6.00	1200	4	0.8	1.2	TO - 218	561
BUW12A		1000	450	8	1.5	6.00	1200	4	0.8	1.2	TO - 218	561
BUW22AP		450	400	6	1.50	2.50	1000	1.5	0.7	2	TO - 220	563
BUW22P		400	350	6	1.50	2.50	1000	1.5	0.7	2	TO - 220	563
BUW32		400	350	10	1.50	5.00	1500	1.5	0.6	1.2	TO - 3	569
BUW32A		450	400	10	1.50	5.00	1500	1.5	0.6	1.2	TO - 3	569
BUW32AP		450	400	10	1.50	5.00	1500	1.5	0.6	1.2	SOT - 93	569
BUW32APFI		450	400	10	1.50	5.00	1500	1.5	0.6	2.27	ISOWATT218	569
BUW32P		400	350	10	1.50	5.00	1500	1.5	0.6	1.2	SOT - 93	569
BUW32PFI		400	350	10	1.50	5.00	1500	1.5	0.6	2.27	ISOWATT218	569
BUW34		500	400	10	1.50	5.00	1000	3	0.8	1.4	TO - 3	575
BUW35		800	400	10	1.50	5.00	1000	3	0.8	1.4	TO - 3	575
BUW36		900	450	10	1.50	5.00	1000	3	0.8	1.4	TO - 3	575
BUW38		120	60	30	0.60	20.00	2000	1.1	0.39	1.17	TO - 3	583
BUW39		160	80	30	0.50	15.00	1500	1.1	0.39	1.17	TO - 3	583
BUW42		400	350	15	1.50	10.00	3000	1.5	0.6	1	TO - 3	593
BUW42A		450	400	15	1.50	10.00	3000	1.5	0.6	1	TO - 3	593
BUW42AP		450	400	15	1.50	10.00	3000	1.5	0.5	1.2	SOT - 93	593
BUW42APFI		450	400	15	1.50	10.00	3000	1.5	0.6	1.92	ISOWATT218	593
BUW42P		400	350	15	1.50	10.00	3000	1.5	0.6	1.2	SOT - 93	593

PNP Type in bold.

▲ Inductive load

T_j = 125°C

■ T_j = 100°C

* Datasheet available on request

SWITCHING TRANSISTORS (cont'd)

Type	Complementary	V _{CB0} (V)	V _{CEO} (V)	I _C (A)	V _{CEsat} @ (V)	I _C (A)	I _B (mA)	t _s (μs)	t _f (μs)	R _{thj-c} (°C/W)	Case	Page
BUW42PFI		400	350	15	1.50	10.00	3000	1.5	0.6	1.92	ISOWATT218	593
BUW44		500	400	15	3.00	10.00	2000	3	0.8	1	TO - 3	597
BUW45		800	400	15	1.50	10.00	2000	3	0.8	1	TO - 3	597
BUW46		900	450	15	1.50	10.00	2000	3	0.8	1	TO - 3	597
BUW48		120	60	30	0.60	20.00	2000	1.1	0.25	1	TO - 218	601
BUW49		160	80	30	0.50	15.00	1500	1.1	0.25	1	TO - 218	601
BUW50		250	125	25	0.90	20.00	2000	1.2	0.3	1	TO - 218	609
BUW51		300	200	20	0.90	10.00	1000	1.4	0.3	1	TO - 218	617
BUW52		350	250	20	0.80	4.00	260	1.6	0.3	1	SOT - 93	625
BUW89		160	90	25	0.90	15.00	1500	1	0.25	1.2	TO - 218	633
BUW90		250	125	20	0.90	11.00	1100	1	0.3	1.2	TO - 218	641
BUW91		300	200	15	0.90	6.00	600	1.2	0.3	1.2	TO - 218	649
BUW92		350	250	12	0.80	2.00	130	1.6	0.3	1.2	TO - 218	657
BUX10		160	125	25	0.60	10.00	1000	1.2	0.3	1.17	TO - 3	665
BUX10P		160	125	25	0.60	10.00	1000	1.2	0.3	1.17	TO - 218	669
BUX11		250	200	20	0.60	6.00	600	1.8	0.4	1.17	TO - 3	671
BUX11N		220	160	20	0.60	8.00	800	1.5	0.5	1.17	TO - 3	675
BUX12		300	250	20	1.00	5.00	500	2	0.5	1.17	TO - 3	679
BUX13		400	325	15	1.50	8.00	1600	3	1.2	1.17	TO - 3	683
BUX14		450	400	10	1.60	6.00	1200	3	1.2	1.17	TO - 3	685
BUX20		160	125	50	0.60	25.00	2500	1.2	0.3	0.5	TO - 3	687
BUX21		250	200	40	0.60	12.00	1200	1.8	0.4	0.5	TO - 3	691
BUX22		300	250	40	1.00	10.00	1000	2	0.5	0.5	TO - 3	695
BUX23		400	325	30	1.00	16.00	3200	2.5	1.2	0.5	TO - 3	699
BUX24		450	400	20	1.00	12.00	2400	3	1.4	0.7	TO - 3	705
BUX25		500	500	30	1.00	8.00	1600	5	1.2	0.5	TO - 3	711
BUX40		160	125	20	1.20	10.00	1000	1	0.4	1.46	TO - 3	715
BUX41		250	200	15	1.20	4.00	400	1.7	0.8	1.46	TO - 3	719
BUX41N		220	160	18	1.20	8.00	800	1.5	0.8	1.46	TO - 3	723
BUX42		300	250	12	1.20	4.00	400	2	1.2	1.46	TO - 3	727
BUX43		400	325	10	2.00	5.00	1000	2.2	1.2	1.46	TO - 3	731
BUX44		450	400	8	1.50	4.00	800	2.5	1.2	1.46	TO - 3	733
BUX47		850	400	9	1.5	6.00	1200	2.5	0.8	1.2	TO - 3	735
BUX47A		1000	450	9	1.5	5.00	1000	2.5	0.8	1.2	TO - 3	735
BUX48		850	400	15	1.5	10.00	2000	3	0.8	1	TO - 3	745
BUX48A		1000	450	15	1.5	8.00	1600	3	0.8	1	TO - 3	745
BUX48B		1200	600	15	1.5	6.00	1500	3	0.7	1	TO - 3	755
BUX48C		1200	700	15	1.5	6.00	1500	3	0.7	1	TO - 3	755
BUX80		800	400	10	1.5	5.00	1000	3.5	0.5	1.75	TO - 3	761
BUX84		800	400	2	3.0	1.00	200	3.5	0.4●	3.12	TO - 220	765
BUX85		1000	450	2	1.0	1.00	200	3.5	0.4●	2.5	TO - 220	*
BUX98		850	400	30	1.5	20.00	4000	3	0.8	0.7	TO - 3	767
BUX98A		1000	450	30	1.5	16.00	3200	3	0.8	0.7	TO - 3	767
BUX98B		1200	600	30	1.5	12.00	3000	3	0.8	0.7	TO - 3	769
BUX98C		1200	700	30	1.5	12.00	3000	3	0.8	0.7	TO - 3	769

PNP Type in bold.

● Typical value

* Datasheet available on request

SELECTION GUIDE BY PART NUMBER

SWITCHING TRANSISTORS (cont'd)

Type	Complementary	V _{CB0} (V)	V _{CEO} (V)	I _C (A)	V _{CEsat} (V)	I _C (A)	I _B (mA)	t _s (μs)	t _f (μs)	R _{thj-c} (°C/W)	Case	Page
BUX98P		850	450	30	0.9	20.00	4000	3	0.8	0.63	TO - 218	773
BUX348		850	450	45	0.9	30.00	6000			0.58	TO - 3	779
BUY47		150	120	7	1.00	5.00	500	0.7	0.04	15	TO - 39	785
BUY48		200	170	7	1.00	5.00	500	0.7	0.04●	15	TO - 39	785
BUY49P		250	200	3	0.20	0.50	50	0.75	0.20	8.33	SOT - 32	789
BUY49S		250	200	3	0.20	0.50	50	0.75	0.30	17.5	TO - 39	791
BUY69A		1000	400	10	3.3	8.00	2500	1.7●	0.3●	1.75	TO - 3	799
BUY69B		800	325	10	3.3	8.00	2500	1.7●	0.3●	1.75	TO - 3	799
BUY69C		500	200	10	3.3	8.00	2500	1.7●	0.3●	1.75	TO - 3	799
D44Q1		200	125	4	1.00	2.00	200	2	1.7	4	TO - 220	805
D44Q3		250	175	4	1.00	2.00	200	2	1.7	4	TO - 220	805
D44Q5		300	225	4	1.00	2.00	200	2	1.7	4	TO - 220	805
ESM2012D(V)		150	125	120	1.5#	70	250	2▲	0.4▲	0.7	ISOTOP	*
ESM2030D(V)		400	300	67	2.0#	56	1600	3.5▲	0.7▲	0.83	ISOTOP	*
ESM3030D(V)		400	300	100	1.7#	60	600	3.5▲	0.7▲	0.83	ISOTOP	*
ESM3045A(V)		1000	450	24	2.0#	18	720	4.5▲	0.5▲	1	ISOTOP	*
ESM3045D(V)		600	450	24	2.0#	15	300	4▲	0.4▲	1	ISOTOP	*
ESM4045A(V)		1000	450	42	2.0#	30	1200	5▲	0.6▲	0.83	ISOTOP	*
ESM4045D(V)		600	450	42	2.0#	25	500	4.5▲	0.5▲	0.83	ISOTOP	*
ESM5045D(V)		600	450	60	2.0#	35	700	5▲	0.5▲	0.71	ISOTOP	*
ESM6045A(V)		1000	450	84	2.0#	60	2400	6▲	0.6▲	0.5	ISOTOP	*
ESM6045D(V)		600	450	84	2.0#	50	1000	5.5▲	0.5▲	0.5	ISOTOP	*
ESM7545D(V)		600	450	75	2.5	75	1500	5▲●	1▲●	0.41	ISOTOP	*
ESMT5070D(V)		1000	700	50	3.0	50	500	15▲	3▲	0.41	ISOTOP	*
MJ10004		400	350	20	1.90	10.00	400	1.5	0.5	1	TO - 3	823
MJ10004P		400	350	20	1.90	10.00	400	1.5	0.5	1	TO - 218	823
MJ10004PFI		400	350	20	1.90	10.00	400	1.5	0.5	2.08	ISOWATT218	823
MJ10005		450	400	20	1.90	10.00	400	1.5	0.5	1	TO - 3	823
MJ10005P		450	400	20	1.90	10.00	400	1.5	0.5	1	TO - 218	823
MJ10005PFI		450	400	20	1.90	10.00	400	1.5	0.5	2.08	ISOWATT218	823
MJ13335		800	500	20	1.8	10.00	2000				TO - 3	*
MJE340	MJE350	300	300	0.5						6	SOT - 32	837
MJE340T	MJE350T	300	300	0.5						6	TO - 220	837
MJE350	MJE340	300	300	0.5						6	SOT - 32	837
MJE350T	MJE340T	300	300	0.5						6	TO - 220	837
MJE3439		450	350	0.3	0.50	0.05	4			8.33	SOT - 32	855
MJE3440		350	250	0.3	0.50	0.05	4			8.33	SOT - 32	855
MJE13004		600	300	4	1.00	4.00	1000	4	0.9	1.67	TO - 220	859
MJE13005		700	400	4	1.0	4.00	1000	4	0.9	1.67	TO - 220	859
MJE13006		600	300	8	1.50	5.00	1000	3	0.7	1.56	TO - 220	863
MJE13007		700	400	8	1.5	5.00	1000	3	0.7	1.56	TO - 220	863
MJE13007A		850	400	8	1.5	5.00	1000	3	0.7	1.56	TO - 220	863
MJE13008		600	300	12	1.50	8.00	1600	3	0.7	1.25	TO - 220	871
MJE13009		700	400	12	1.5	8.00	1600	3	0.7	1.25	TO - 220	871
MJH16006		850	450	8	3.0	5.00	660				TO - 218	*

PNP Type in bold. ▲ Inductive load ● Typical value #T_J = 125°C ■ T_J = 100°C * Datasheet available on request

SWITCHING TRANSISTORS (cont'd)

Type	Complementary	V _{CEO} (V)	V _{CE0} (V)	I _C (A)	V _{CEsat} @ (V)	I _C (A)	I _B (mA)	t _s (μs)	t _f (μs)	R _{thj-c} (°C/W)	Case	Page
MJH16008		850	450	8	3.0	5.00	500				TO - 218	*
MJH16010		850	450	15	3.0	10.00	1300				TO - 218	*
MJH16012		850	450	15	3.0	10.00	1000				TO - 218	*
S2000FI		1500	700	7.5	5.0	4.50	2000				ISOWATT218	*
S2056FI		1500	700	2.5	5.0	2.00	1000				ISOWATT218	*
SGS340	SGS350	300	300	0.5						6	SOT - 82	837
SGS350	SGS340	300	300	0.5						6	SOT - 82	837
SGS3439		450	350	0.3	0.50	0.05	4			8.33	SOT - 82	855
SGS3440		350	250	0.3	0.50	0.05	4			8.33	SOT - 82	855
SGS13002		600	300	1.5	1.00	1.00	250	2.5	0.5	2.5	SOT - 82	877
SGS13002T		600	300	1.5	1.00	1.00	250	2.5	0.5	2.5	TO - 220	877
SGS13003		700	400	1.5	1.0	1.00	250	2.5	0.5	2.5	SOT - 82	877
SGS13003T		700	400	1.5	1.0	1.00	250	2.5	0.5	2.5	TO - 220	877
SGSD00020		650	400	8	4.00	3.00	3				TO - 220	895
SGSD00030		650	400	28	2.50	12.00	100	1.5	0.5	1	TO - 218	897
SGSD00030FI		650	400	28	2.50	12.00	100	1.5	0.5	2.08	ISOWATT218	897
SGSD00031		650	400	28	2.50	12.00	100	1.5	0.5	1	TO - 3	897
SGSD00055		1000	400	7	2.5	3.00	200	0.8	0.15	1.66	TO - 220	905
SGSD310		600	400	28	2.50	18.00	1800	1.5	0.5	1	TO - 3	889
SGSD311		600	400	28	2.50	18.00	1800	1.5	0.5	1	TO - 218	889
SGSD311FI		600	400	28	2.50	18.00	1800	1.5	0.5	2.08	ISOWATT218	889
SGSF321		850	400	5	1.5	3.50	700	2.5	0.3	1.78	TO - 220	907
SGSF323		1000	450	5	1.5	2.50	500	2.5	0.3	1.78	TO - 220	913
SGSF324		1200	600	4	1.5	1.75	350	4.5	0.35	1.78	TO - 220	919
SGSF341		850	400	10	1.5	6.00	1200	2.5	0.3	1.47	TO - 220	931
SGSF343		1000	450	8	1.5	4.50	900	2.5	0.35	1.47	TO - 220	937
SGSF344		1200	600	7	1.5	3.50	700	3.5	0.3	1.47	TO - 220	943
SGSF421		850	400	5	1.5	3.50	700	2.5	0.3	1.56	TO - 218	907
SGSF423		1000	450	5	1.5	2.50	500	2.5	0.3	1.56	TO - 218	913
SGSF424		1200	600	4	1.5	1.75	350	4.5	0.35	1.56	TO - 218	919
SGSF425		1300	600	4	1.5	1.25	250	4.5	0.35	1.56	TO - 218	925
SGSF441		850	400	10	1.5	6.00	1200	2.5	0.3	1.31	TO - 218	931
SGSF443		1000	450	8	1.5	4.50	900	2.5	0.35	1.31	TO - 218	937
SGSF444		1200	600	7	1.5	3.50	700	3.5	0.3	1.31	TO - 218	943
SGSF445		1300	600	7	1.5	3.00	600	3.5	0.3	1.31	TO - 218	949
SGSF461		850	400	15	1.5	10.00	2000	2.3	0.5	1	TO - 218	955
SGSF463		1000	450	12	1.5	7.00	1400	2.3	0.5	1	TO - 218	961
SGSF464		1200	600	10	1.5	6.00	1200	3.5	0.4	1	TO - 218	967
SGSF465		1300	600	10	1.5	5.00	1000	3.5	0.4	1	TO - 218	973
SGSF541		850	400	10	1.5	6.00	1200	2.5	0.35	1.3	TO - 3	931
SGSF543		1000	450	8	1.5	4.50	900	2.5	0.35	1.3	TO - 3	937
SGSF544		1200	600	7	1.5	3.50	700	3.5	0.3	1.3	TO - 3	943
SGSF561		850	400	15	1.5	10.00	2000	2.3	0.5	1	TO - 3	955
SGSF563		1000	450	12	1.5	7.00	1400	2.3	0.5	1	TO - 3	961
SGSF564		1200	600	10	1.5	6.00	1200	3.5	0.4	1	TO - 3	967

PNP Type in bold.

* Datasheet available on request

SWITCHING TRANSISTORS (cont'd)

Type	Complementary	V _{CEO} (V)	V _{CE0} (V)	I _C (A)	V _{CEsat} @ (V)	I _C (A)	I _B (mA)	t _s (μs)	t _f (μs)	R _{thj-c} (°C/W)	Case	Page
SGSF565		1300	600	10	1.5	5.00	1000	3.5	0.4	1	TO - 3	973
SGSF661		850	400	30	1.5	20.00	4000	2.3	0.5	0.6	TO - 3	979
SGSF663		1000	450	24	1.5	14.00	2800	2.3	0.5	0.6	TO - 3	983
SGSF664		1200	600	20	1.5	12.00	2400	3.5	0.4	0.6	TO - 3	987
SGSF665		1300	600	20	1.5	10.00	2000	3.5	0.4	0.6	TO - 3	991
SGSIF321		850	400	5	1.5	3.50	700	2.5	0.3	3.57	ISOWATT220	907
SGSIF323		1000	450	5	1.5	2.50	500	2.5	0.3	3.57	ISOWATT220	913
SGSIF324		1200	600	4	1.5	1.75	350	4.5	0.35	3.57	ISOWATT220	919
SGSIF341		850	400	10	1.5	6.00	1200	2.5	0.3	3.12	ISOWATT220	931
SGSIF343		1000	450	8	1.5	4.50	900	2.5	0.35	3.12	ISOWATT220	937
SGSIF344		1200	600	7	1.5	3.50	700	3.5	0.3	3.12	ISOWATT220	943
SGSIF421		850	400	5	1.5	3.50	700	2.5	0.3	2.77	ISOWATT218	907
SGSIF423		1000	450	5	1.5	2.50	500	2.5	0.3	2.77	ISOWATT218	913
SGSIF424		1200	600	4	1.5	1.75	350	4.5	0.35	2.77	ISOWATT218	919
SGSIF425		1300	600	4	1.5	1.25	250	4.5	0.35	2.77	ISOWATT218	925
SGSIF441		850	400	10	1.5	6.00	1200	2.5	0.3	2.77	ISOWATT218	931
SGSIF443		1000	450	8	1.5	4.50	900	2.5	0.35	2.77	ISOWATT218	937
SGSIF444		1200	600	7	1.5	3.50	700	3.5	0.3	2.77	ISOWATT218	943
SGSIF445		1300	600	7	1.5	3.00	600	3.5	0.3	2.77	ISOWATT218	949
SGSIF461		850	400	15	1.5	10.00	2000	2.3	0.5	1.92	ISOWATT218	955
SGSIF463		1000	450	12	1.5	7.00	1400	2.3	0.5	1.92	ISOWATT218	961
SGSIF464		1200	600	10	1.5	6.00	1200	3.5	0.4	1.92	ISOWATT218	967
SGSIF465		1300	600	10	1.50	1.50	5000	3.5	0.4	1.92	ISOWATT218	973
TIP47		350	250	1	1.00	1.00	200	1.2●	0.45●	3.12	TO - 220	1005
TIP48		400	300	1	1.00	1.00	200	1.3●	0.45●	3.12	TO - 220	1005
TIP49		450	350	1	1.00	1.00	200	1.3●	0.45●	3.12	TO - 220	1005
TIP50		500	400	1	1.00	1.00	200	1.3●	0.45●	3.12	TO - 220	1005
TIP51		350	250	5	1.50	3.00	600	2.5●	0.2●	1.25	SOT - 93	1009
TIP52		400	300	5	1.50	3.00	600	2.5●	0.2●	1.25	SOT - 93	1009
TIP53		450	350	5	1.50	3.00	600	2.5●	0.2●	1.25	SOT - 93	1009
TIP54		500	400	5	1.50	3.00	600	2.5●	0.2●	1.25	SOT - 93	1009

● Typical value

GENERAL PURPOSE TRANSISTORS

V _{CEO} (V)	V _{CBO} (V)	I _C (A)	TYPE		h _{FE} @ I _C (A)	V _{CE} (V)	V _{CEsat} @ I _C (V)	I _B (mA)	R _{thj-c} (°C/W)	Case	Page		
			NPN	PNP									
22	22	4	BD433	BD434	50	2.00	1.0	0.50	2.00	200	3.5	SOT- 32	163
25	40	5	MJE200	MJE210	70	0.50	1.0	0.30	0.50	50	8.34	SOT - 32	833
30	30	3	MJE520	MJE370	25	1.00	1.0				5	SOT - 32	841
30	30	10	D44H1	D45H1	20	4.00	1.0	1.00	8.00	800	2.5	TO - 220	803
30	30	10	D44H2	D45H2	40	4.00	1.0	1.00	8.00	400	2.5	TO - 220	803
30	40	4	D44C1		10	1.00	1.0	0.50	1.00	100	4.2	TO - 220	801
30	40	4	D44C2		20	1.00	1.0	0.50	1.00	50	4.2	TO - 220	801
30	40	4	D44C3		20	2.00	1.0	0.50	1.00	50	4.2	TO - 220	801
30	40	7	2N6288	2N6111	30	4.00	3.0	1.00	3.00	300	1.92	TO - 220	1140
32	32	4	BD435	BD436	50	2.00	1.0	0.50	2.00	200	3.5	SOT - 32	163
40	40	1	2N4921	2N4918	30	0.50	1.0	0.60	1.00	100	4.16	SOT - 32	1063
40	40	3		2N4234	20	0.50	1.0	0.60	1.00	100	29	TO - 39	1057
40	40	4	2N5190	2N5193	25	1.50	2.0	0.60	1.50	150	3.12	SOT - 32	1077
40	40	4	2N6037	2N6034	500	0.50	3.0	2.00	2.00		8	SOT - 32	1131
40	40	4	MJE521	MJE371	40	1.00	1.0				3.12	SOT - 32	845
40	40	8	2N6386		1000	3.00	3.0	2.00	3.00	6	1.92	TO - 220	1153
40	40	30	2N5301	2N4398	15	15.00	2.0	1.00	15.00	1500	0.875	TO - 3	1083
40	50	15	2N3771		15	15.00	4.0	2.00	15.00	1500	1.17	TO - 3	1053
40	60	3	MJE180	MJE170	30	0.50	1.0	0.90	1.50	150	10	SOT - 32	829
40	80	3	TIP31	TIP32	25	1.00	4.0	1.20	3.00	375	3.12	TO - 220	995
40	80	6	TIP41	TIP42	15	3.00	4.0	1.50	6.00	600	1.92	TO - 220	1003
45	45	1.5	BD135	BD136	25	0.50	2.0	0.50	0.50	50	10	SOT - 32	133
45	45	2	BD233	BD234	25	1.00	2.0	0.60	1.00	100	5	SOT - 32	149
45	45	2	BD239	BD240	15	1.00	4.0	0.70	1.00	200	4.16	TO - 220	153
45	45	3	BD175	BD176	15	1.00	2.0	0.80	1.00	100	4.16	SOT - 32	143
45	45	3	BD241	BD242	25	1.00	4.0	1.20	3.00	600	4.16	TO - 220	155
45	45	4	2N6121	2N6124	25	1.00	2.0	0.60	1.50	150	3.12	TO - 220	1143
45	45	4	BD437	BD438	40	2.00	1.0	0.60	2.00	200	3.5	SOT - 32	163
45	45	4	BD675	BD676	750	1.50	3.0	2.50	1.50	30	3.12	SOT - 32	175
45	45	4	BD675A	BD676A	750	2.00	3.0	2.80	2.00	40	3.12	SOT - 32	175
45	45	6	BD243	BD244	15	3.00	4.0	1.50	6.00	1000	4.16	TO - 220	157
45	45	8	BD533	BD534	25	2.00	2.0	0.80	2.00	200	2.5	TO - 220	171
45	45	8	BDX53	BDX54	750	3.00	3.0	2.00	3.00	12	2.08	TO - 220	217
45	45	10	BDX33	BDX34	750	4.00	3.0	2.50	4.00	8	1.78	TO - 220	211
45	45	10	BDX85	BDX86	1000	3.00	3.0	2.00	4.00	16	1.75	TO - 3	227
45	45	10	D44H4	D45H4	20	4.00	1.0	1.00	8.00	800	2.5	TO - 220	803
45	45	10	D44H5	D45H5	40	4.00	1.0	1.00	8.00	400	2.5	TO - 220	803
45	45	12	BD705	BD706	20	4.00	4.0	1.00	4.00	400	1.67	TO - 220	179
45	45	12	BDW93	BDW94	750	5.00	3.0	2.00	5.00	20	1.56	TO - 220	205
45	45	15	BD905	BD906	15	5.00	4.0	1.00	5.00	500	1.4	TO - 220	185
45	45	15	BDW51	BDW52	20	5.00	4.0	1.00	5.00	500	1.4	TO - 3	193
45	55	4	D44C4		10	1.00	1.0	0.50	1.00	100	4.2	TO - 220	801
45	55	4	D44C5		20	1.00	1.0	0.50	1.00	50	4.2	TO - 220	801
45	55	4	D44C6		20	2.00	1.0	0.50	1.00	50	4.2	TO - 220	801
50	50	15	2N6486	2N6489	20	5.00	4.0	1.30	5.00	500	1.67	TO - 220	1157

SELECTION GUIDE BY VOLTAGE

GENERAL PURPOSE TRANSISTORS (cont'd)

V _{CEO} (V)	V _{CBO} (V)	I _C (A)	TYPE		h _{FE} @	I _C (A)	V _{CE} (V)	V _{CEsat} (V)	I _C (A)	I _B (mA)	R _{thj-c} (°C/W)	Case	Page
			NPN	PNP									
50	60	7	2N6290	2N6109	30	4.00	2.5	1.00	2.50	250	3.12	TO - 220	1140
60	60	1	2N4922	2N4919	30	0.50	1.0	0.60	1.00	100	4.16	SOT - 32	1063
60	60	1.5	BD137	BD138	25	0.50	2.0	0.50	0.50	50	10	SOT - 32	133
60	60	2	BD235	BD236	25	1.00	2.0	0.60	1.00	100	5	SOT - 32	149
60	60	2	BD239A	BD240A	15	1.00	4.0	0.70	1.00	200	3.12	TO - 220	153
60	60	3	BD177	BD178	15	1.00	2.0	0.80	1.00	100	4.16	SOT - 32	143
60	60	3	BD241A	BD242A	25	1.00	4.0	1.20	3.00	600	3.12	TO - 220	155
60	60	4	2N5191	2N5194	25	1.50	2.0	0.60	1.50	150	3.12	SOT - 32	1077
60	60	4	2N6038	2N6035	500	0.50	3.0	2.00	2.00	8	3.12	SOT - 32	1131
60	60	4	2N6122	2N6125	25	1.50	2.0	0.60	1.50	150	3.12	TO - 220	1143
60	60	4	BD439	BD440	25	2.00	1.0	0.80	2.00	200	3.5	SOT - 32	169
60	60	4	BD677	BD678	750	1.50	3.0	2.50	1.50	30	3.12	SOT - 32	175
60	60	4	BD677A	BD678A	750	2.00	3.0	2.80	2.00	40	3.12	SOT - 32	175
60	60	4	MJE800	MJE700	750	1.50	3.0	3.00	4.00	40	3.12	SOT - 32	849
60	60	4	MJE801	MJE701	750	2.00	3.0	3.00	4.00	40	3.12	SOT - 32	849
60	60	4	SGS110	SGS115	1000	1.00	4.0	2.50	2.00	8	2.5	SOT - 82	1017
60	60	4	TIP110	TIP115	1000	1.00	4.0	2.50	2.00	8	2.5	TO - 220	1017
60	60	5	TIP120	TIP125	1000	3.00	3.0	2.00	3.00	12	1.92	TO - 220	1023
60	60	6	BD243A	BD244A	15	3.00	4.0	1.50	6.00	1000	3.12	TO - 220	157
60	60	6	BD331	BD332	750	3.00	3.0	2.00	3.00	12	2.08	SOT - 82	159
60	60	8	2N6055	2N6053	750	4.00	3.0	2.00	4.00	16	1.75	TO - 3	1139
60	60	8	BD535	BD536	25	2.00	2.0	0.80	2.00	200	2.5	SOT - 82	171
60	60	8	BDX53A	BDX54A	750	3.00	3.0	2.00	3.00	12	2.08	SOT - 82	217
60	60	8	MJ1000	MJ900	1000	3.00	3.0	2.00	3.00	12	1.94	TO - 3	815
60	60	8	SGS130	SGS135	1000	4.00	4.0	2.00	4.00	16	1.78	SOT - 82	1029
60	60	8	TIP100	TIP105	1000	3.00	4.0	2.00	3.00	6	1.56	TO - 220	1011
60	60	8	TIP130	TIP135	1000	4.00	4.0	2.00	4.00	16	1.78	TO - 220	1029
60	60	10	2N5877	2N5875	20	4.00	4.0	1.00	5.00	500	1.17	TO - 3	1115
60	60	10	2N6387		1000	5.00	3.0	2.00	5.00	10	1.92	TO - 220	1153
60	60	10	BDX33A	BDX34A	750	4.00	3.0	2.50	4.00	8	1.78	TO - 220	211
60	60	10	BDX85A	BDX86A	1000	3.00	3.0	2.00	4.00	16	1.75	TO - 3	227
60	60	10	D44H7	D45H7	20	4.00	1.0	1.00	8.00	800	2.5	TO - 220	803
60	60	10	D44H8	D45H8	40	4.00	1.0	1.00	8.00	400	2.5	TO - 220	803
60	60	10	MJ3000	MJ2500	1000	5.00	3.0	2.00	5.00	20	1.17	TO - 3	817
60	60	10	TIP140	TIP145	1000	5.00	4.0	3.00	10.00	40	1	TO - 218	1031
60	60	12	2N6057	2N6050	750	6.00	3.0	2.00	6.00	24	1.17	TO - 3	1137
60	60	12	BD707	BD708	15	4.00	4.0	1.00	4.00	400	1.67	TO - 220	179
60	60	12	BDV65	BDV64	1000	5.00	4.0	2.00	5.00	20	1	TO - 218	189
60	60	12	BDW93A	BDW94A	750	5.00	3.0	2.00	5.00	20	1.56	TO - 220	205
60	60	12	BDX87A	BDX88A	1000	5.00	3.0	2.00	6.00	24	1.75	TO - 3	233
60	60	15	BD907	BD908	15	5.00	4.0	1.00	5.00	500	1.4	TO - 220	185
60	60	15	BDW51A	BDW52A	20	5.00	4.0	1.00	5.00	500	1.4	TO - 3	193
60	60	15	BDW83A	BDW84A	750	6.00	3.0	2.50	6.00	12	0.96	TO - 218	199
60	60	16	MJ4033	MJ4030	1000	10.00	3.0	4.00	16.00	80	1.17	TO - 3	821
60	60	20	2N6282	2N6285	750	10.00	3.0	3.00	20.00	200	1.09	TO - 3	1149

GENERAL PURPOSE TRANSISTORS (cont'd)

V _{CEO} (V)	V _{CB0} (V)	I _C (A)	TYPE		h _{FE} @		V _{CE} (V)	V _{CEsat} @ (V)	I _C (A)	I _B (mA)	R _{thj-c} (°C/W)	Case	Page
			NPN	PNP	I _C (A)	I _C (A)							
60	60	25	2N5885	2N5883	20	10.00	4.0	1.00	15.00	1500	0.875	TO - 3	1121
60	60	30	2N5302	2N4399	15	15.00	2.0	1.00	15.00	1500	0.875	TO - 3	1083
60	60	30	MJ11012	MJ11011	1000	20.00	5.0	4.00	30.00	300	0.875	TO - 3	825
60	60	15	TIP140T	TIP145T	1000	5.00	4.0	3.00	10.00	40	1.25	TO - 220	1035
60	65	5		BSS44	40	2.00	2.0	1.00	5.00	500	35	TO - 39	247
60	70	4	D44C7		10	1.00	1.0	0.50	1.00	100	4.2	TO - 220	801
60	70	4	D44C8		20	1.00	1.0	0.50	1.00	50	4.2	TO - 220	801
60	70	4	D44C9		20	2.00	1.0	0.50	1.00	50	4.2	TO - 220	801
60	70	10	MJE3055T	MJE2955T	20	4.00	4.0	1.10	4.00	400	1.66	TO - 220	853
60	80	3	MJE181	MJE171	30	0.50	1.0	0.90	1.50	150	10	SOT - 32	829
60	80	10	2N3715	2N3791	30	3.00	2.0	0.80	5.00	500	1.17	TO - 3	1047
60	100	3	TIP31A	TIP32A	25	1.00	4.0	1.20	3.00	375	3.12	TO - 220	995
60	100	5	BFX34		40	2.00	2.0	1.00	5.00	500	35	TO - 39	243
60	100	6	TIP41A	TIP42A	15	3.00	4.0	1.50	6.00	600	1.92	TO - 220	1003
60	100	7	BUY68		40	1.00	1.0	1.00	5.00	500	17.5	TO - 39	795
60	100	10	TIP33A	TIP34A	20	3.00	4.0	1.00	3.00	300	1.39	TO - 218	999
60	100	15	2N3055	MJ2955	20	4.00	4.0	1.10	4.00	400	1.5	TO - 3	1039
60	100	15	2N3772		15	10.00	4.0	1.40	10.00	1000	1.17	TO - 3	1053
60	100	15	TIP3055	TIP2955	20	4.00	4.0	1.10	4.00	400	1.39	TO - 218	1037
60	100	25	TIP35A	TIP36A	10	15.00	4.0	1.80	15.00	1500	1	TO - 218	1001
70	70	15	2N6487	2N6490	20	5.00	4.0	1.30	5.00	500	1.67	TO - 220	1157
70	80	7	2N6292	2N6107	30	4.00	2.0	1.00	2.00	200	3.12	TO - 220	1140
80	80	1	2N4923	2N4920	30	0.50	1.0	0.60	1.00	100	4.16	SOT - 32	1063
80	80	1.5	BD139	BD140	25	0.50	2.0	0.50	0.50	50	10	SOT - 32	133
80	80	2	BD239B	BD240B	15	1.00	4.0	0.70	1.00	200	4.16	TO - 220	155
80	80	3	BD179	BD180	15	1.00	2.0	0.80	1.00	100	4.16	SOT - 32	143
80	80	3	BD241B	BD242B	25	1.00	4.0	1.20	3.00	600	3.12	TO - 220	155
80	80	4	2N5192	2N5195	20	1.50	2.0	0.60	1.50	150	3.12	SOT - 32	1077
80	80	4	2N6039	2N6036	500	0.50	3.0	2.00	2.00	8	3.12	SOT - 32	1131
80	80	4	2N6123	2N6126	20	1.50	2.0	0.60	1.50	150	3.12	TO - 220	1143
80	80	4	BD441	BD442	15	2.00	1.0	0.80	2.00	200	3.5	SOT - 32	169
80	80	4	BD679	BD680	750	1.50	3.0	2.50	1.50	30	3.12	SOT - 32	175
80	80	4	BD679A	BD680A	750	2.00	3.0	2.80	2.00	40	3.12	SOT - 32	175
80	80	4	MJE802	MJE702	750	1.50	3.0	3.00	4.00	40	3.12	SOT - 32	849
80	80	4	MJE803	MJE703	750	2.00	3.0	3.00	4.00	40	3.12	SOT - 32	849
80	80	4	SGS111	SGS116	1000	1.00	4.0	2.50	2.00	8	2.5	SOT - 82	1017
80	80	4	TIP111	TIP116	1000	1.00	4.0	2.50	2.00	8	2.5	TO - 220	1017
80	80	5	2N5336		20	5.00	2.0	1.20	5.00	500	29	TO - 39	1089
80	80	5	2N5337		40	5.00	2.0	1.20	5.00	500	29	TO - 39	1089
80	80	5	TIP121	TIP126	1000	3.00	3.0	2.00	3.00	12	1.92	TO - 220	1023
80	80	6	BD243B	BD244B	15	3.00	4.0	1.50	6.00	1000	1.92	TO - 220	157
80	80	6	BD333	BD334	750	3.00	3.0	2.00	3.00	12	2.08	SOT - 82	159
80	80	8	BD537	BD538	15	2.00	2.0	0.80	2.00	200	2.5	TO - 220	171
80	80	8	BDX53B	BDX54B	750	3.00	3.0	2.00	3.00	12	2.08	TO - 220	217
80	80	8	MJ1001	MJ901	1000	3.00	3.0	2.00	3.00	12	1.94	TO - 3	815

SELECTION GUIDE BY VOLTAGE

GENERAL PURPOSE TRANSISTORS (cont'd)

V _{CEO} (V)	V _{CBO} (V)	I _C (A)	TYPE		h _{FE} @ I _C (A)	V _{CE} (V)	V _{CEsat} (V)	I _C (A)	I _B (mA)	R _{thj-c} (°C/W)	Case	Page	
			NPN	PNP									
80	80	8	SGS131	SGS136	1000	4.00	4.0	2.00	3.00	6	1.56	TO - 220	1011
80	80	8	TIP101	TIP106	1000	3.00	4.0	2.00	3.00	6	1.56	TO - 220	1011
80	80	8	TIP131	TIP136	1000	4.00	4.0	2.00	4.00	16	1.78	TO - 220	1029
80	80	10	2N5878	2N5876	20	4.00	4.0	1.00	5.00	500	1.17	TO - 3	1115
80	80	10	2N6388		1000	5.00	3.0	2.00	5.00	10	1.92	TO - 220	1153
80	80	10	BDX33B	BDX34B	750	3.00	3.0	2.50	3.00	6	1.78	TO - 220	211
80	80	10	BDX85B	BDX86B	1000	3.00	3.0	2.00	4.00	16	1.75	TO - 3	227
80	80	10	D44H10	D45H10	20	4.00	1.0	1.00	8.00	800	2.5	TO - 220	803
80	80	10	D44H11		40	4.00	1.0	1.00	8.00	400	2.5	TO - 220	803
80	80	10	MJ3001	MJ2501	1000	5.00	3.0	2.00	5.00	20	1.17	TO - 3	817
80	80	10	TIP141	TIP146	1000	5.00	4.0	3.00	10.00	40	1	TO - 218	1031
80	80	12	2N6058	2N6051	750	6.00	3.0	2.00	6.00	24	1.17	TO - 3	1137
80	80	12	BD709	BD710	15	4.00	4.0	1.00	4.00	400	1.67	TO - 220	179
80	80	12	BDV65A	BDV64A	1000	5.00	4.0	2.00	5.00	20	1	TO - 218	189
80	80	12	BDW93B	BDW94B	750	5.00	3.0	2.00	5.00	20	1.56	TO - 220	205
80	80	12	BDX87B	BDX88B	1000	5.00	3.0	2.00	6.00	24	1.45	TO - 3	233
80	80	15	BD909	BD910	15	5.00	4.0	1.00	5.00	500	1.4	TO - 220	185
80	80	15	BDW51B	BDW52B	20	5.00	4.0	1.00	5.00	500	1.4	TO - 3	193
80	80	15	BDW83B	BDW84B	750	6.00	3.0	2.50	6.00	12	0.96	TO - 218	199
80	80	16	MJ4034	MJ4031	1000	10.00	3.0	4.00	16.00	80	1.17	TO - 3	821
80	80	20	2N5303	2N5745	15	10.00	2.0	1.50	15.00	1500	0.875	TO - 3	1083
80	80	20	2N6283	2N6286	750	10.00	3.0	3.00	20.00	200	1.09	TO - 3	1149
80	80	25	2N5886	2N5884	20	10.00	4.0	1.00	15.00	1500	0.875	TO - 3	1121
80	80	25	SGSD100	SGSD200	300	20.00	3.0	1.75	10.00	40	0.96	TO - 218	885
80	80	15	TIP141T	TIP146T	1000	5.00	4.0	3.00	10.00	40	1.25	TO - 220	1035
80	90	4	D44C10		10	1.00	1.0	0.50	1.00	100	4.2	TO - 220	801
80	90	4	D44C11		20	1.00	1.0	0.50	1.00	50	4.2	TO - 220	801
80	90	4	D44C12		20	2.00	1.0	0.50	1.00	50	4.2	TO - 220	801
80	100	2	BD237	BD238	25	1.00	2.0	0.60	1.00	100	5	SOT - 32	149
80	100	3	MJE182	MJE172	30	0.50	1.0	0.90	1.50	150	10	SOT - 32	829
80	100	5	2N5152	2N5151	30	2.50	5.0	0.70	2.50	250	15	TO - 39	1075
80	100	5	2N5154	2N5153	70	2.50	5.0	0.70	2.50	250	15	TO - 39	1075
80	100	10	2N3716	2N3792	30	3.00	2.0	0.80	5.00	500	1.17	TO - 3	1047
80	120	3	TIP31B	TIP32B	25	1.00	4.0	1.20	3.00	375	3.12	TO - 220	995
80	120	6	TIP41B	TIP42B	15	3.00	4.0	1.50	6.00	600	1.92	TO - 220	1003
80	120	10	TIP33B	TIP34B	20	3.00	4.0	1.00	3.00	300	1.39	TO - 218	999
80	120	25	TIP35B	TIP36B	10	15.00	4.0	1.80	15.00	1500	1	TO - 218	1001
90	90	15	2N6488	2N6491	20	5.00	4.0	1.30	5.00	500	1.67	TO - 220	1157
90	90	30	MJ11014	MJ11013	1000	20.00	5.0	4.00	30.00	300	0.875	TO - 3	825
90	100	30	MJ802	MJ4502	25	7.50	2.0	0.80	7.50	750	0.875	TO - 3	809
100	100	1	2N5681	2N5679	40	0.25	2.0	1.00	0.50	50	17.5	TO - 39	1113
100	100	2	BD239C	BD240C	15	1.00	4.0	0.70	1.00	200	4.16	TO - 220	153
100	100	3	BD241C	BD242C	25	1.00	4.0	1.20	3.00	600	3.12	TO - 220	155
100	100	4	BD681	BD682	750	1.50	3.0	2.50	1.50	30	3.12	SOT - 32	175
100	100	4	SGS112	SGS117	1000	1.00	4.0	2.50	2.00	8	2.5	SOT - 82	1017

GENERAL PURPOSE TRANSISTORS (cont'd)

V_{CE0} (V)	V_{CBO} (V)	I_C (A)	TYPE		h_{FE} @ I_C (A)	V_{CE} (V)	V_{CEsat} @ I_C (V)	I_C (A)	I_B (mA)	R_{th-c} (°C/W)	Case	Page	
			NPN	PNP									
100	100	4	TIP112	TIP117	1000	1.00	4.0	2.50	2.00	8	2.5	TO - 220	1017
100	100	5	2N5338		20	5.00	2.0	1.20	5.00	500	29	TO - 39	1089
100	100	5	2N5339		40	5.00	2.0	1.20	5.00	500	29	TO - 39	1089
100	100	5	TIP122	TIP127	1000	3.00	3.0	2.00	3.00	12	1.92	TO - 220	1023
100	100	6	BD243C	BD244C	15	3.00	4.0	1.50	6.00	1000	3.12	TO - 220	157
100	100	6	BD335	BD336	750	3.00	3.0	2.00	3.00	12	2.08	SOT - 82	159
100	100	8	2N6045	2N6042	1000	3.00	4.0	2.00	3.00	12	1.56	TO - 220	1135
100	100	8	BDX53C	BDX54C	750	3.00	3.0	2.00	3.00	12	2.08	TO - 220	217
100	100	8	SGS132	SGS137	1000	4.00	4.0	2.00	4.00	16	1.78	SOT - 82	1029
100	100	8	TIP102	TIP107	1000	3.00	4.0	2.00	3.00	6	1.56	TO - 220	1011
100	100	8	TIP132	TIP137	1000	4.00	4.0	2.00	4.00	16	1.78	TO - 220	1029
100	100	10	BDX33C	BDX34C	750	3.00	3.0	2.50	3.00	6	1.78	TO - 220	211
100	100	10	BDX85C	BDX86C	1000	3.00	3.0	2.00	4.00	16	1.17	TO - 3	227
100	100	10	TIP142	TIP147	1000	5.00	4.0	3.00	10.00	40	1	TO - 218	1031
100	100	12	2N6059	2N6052	750	6.00	3.0	2.00	6.00	24	1.17	TO - 3	1137
100	100	12	BD711	BD712	15	4.00	4.0	1.00	4.00	400	1.4	TO - 220	179
100	100	12	BDV65B	BDV64B	1000	5.00	4.0	2.00	5.00	20	1	TO - 218	189
100	100	12	BDW93C	BDW94C	750	5.00	3.0	2.00	5.00	20	1.56	TO - 220	205
100	100	12	BDX87C	BDX88C	1000	5.00	3.0	2.00	6.00	24	1.45	TO - 3	233
100	100	15	BD911	BD912	15	5.00	4.0	1.00	5.00	500	4.2	TO - 220	185
100	100	15	BDW51C	BDW52C	20	5.00	4.0	1.00	5.00	500	1.4	TO - 3	193
100	100	15	BDW83C	BDW84C	750	6.00	3.0	2.50	6.00	12	0.96	TO - 218	199
100	100	16	2N5629	2N6029	25	8.00	2.0	1.00	10.00	1000	0.875	TO - 3	1097
100	100	16	MJ4035	MJ4032	1000	10.00	3.0	4.00	16.00	80	1.17	TO - 3	821
100	100	20	2N6284	2N6287	750	10.00	3.0	3.00	20.00	200	1.09	TO - 3	1149
100	100	15	TIP142T	TIP147T	1000	5.00	4.0	3.00	10.00	40	1.25	TO - 220	1035
100	140	3	TIP31C	TIP32C	25	1.00	4.0	1.20	3.00	375	3.12	TO - 220	995
100	140	6	TIP41C	TIP42C	15	3.00	4.0	1.50	6.00	600	1.92	TO - 220	1003
100	140	10	TIP33C	TIP34C	20	3.00	4.0	1.00	3.00	300	1.39	TO - 218	999
100	140	25	TIP35C	TIP36C	10	15.00	4.0	1.80	15.00	1500	1	TO - 218	1001
120	120	1	2N5682	2N5680	40	0.25	2.0	1.00	0.50	50	17.5	TO - 39	1113
120	120	30	MJ11016	MJ11015	1000	20.00	5.0	4.00	30.00	300	0.875	TO - 3	825
140	140	6	BDX53E	BDX54E	500	2.00	5.0	2.00	2.00	10	2.08	TO - 220	219
140	160	12	SGSD93E		1000	3.00	3.0	2.00	10.00	20	1.56	TO - 220	881
150	150	6	BDX53S	BDX54S	500	2.00	5.0	2.00	2.00	8	11.66	TO - 39	223
160	160	6	BDX53F	BDX54F	500	2.00	5.0	2.00	2.00	10	2.08	TO - 220	219
160	180	12	SGSD93F		1000	3.00	3.0	2.00	10.00	20	1.56	TO - 220	881
180	180	4	BDW91	BDW92	1000	2.00	5.0	2.00	2.00	4	17.5	TO - 39	201
180	200	12	SGSD93G		1000	3.00	3.0	2.00	10.00	20	1.56	TO - 220	881
350	350	15	BU931Z		80	8.00	1.8	1.60	7.00	70	1	TO - 3	343
350	350	15	BU931ZP		80	8.00	1.8	1.60	7.00	70	2.08	ISOWATT218	343
450	400	6	BU911		20	4.00	1.8	1.80	2.50	50	2.08	TO - 220	325
450	400	10	BU921		50	7.00	1.8	1.80	5.00	50	1.25	TO - 3	329
450	400	10	BU921P		50	7.00	1.8	1.80	5.00	50	1.2	TO - 218	329

GENERAL PURPOSE TRANSISTORS (cont'd)

V_{CE0} (V)	V_{CBO} (V)	I_C (A)	TYPE		h_{FE}	@ I_C (A)	V_{CE} (V)	V_{CEsat} (V)	@ I_C (A)	I_B (mA)	R_{thj-c} (°C/W)	Case	Page
			NPN	PNP									
450	400	10	BU921PFI		50	7.00	1.8	1.80	5.00	50	2.27	ISOWATT218	329
450	400	10	BU921T		50	7.00	1.8	1.80	5.00	50	1.2	TO-220	329
450	400	10	BU921TFI		50	1.00	1.8	1.80	5.00	50	3.12	ISOWATT220	*
450	400	15	BU931R		300	5.00	10.0	1.60	7.00	70	1	TO-3	337
450	400	15	BU931RP		300	5.00	10.0	1.60	7.00	70	1	TO-218	337
450	400	15	BU931RPFI		300	5.00	10.0	1.60	7.00	70	2.08	ISOWATT218	337

* Datasheet available on request

SWITCHING TRANSISTORS

V _{CB0} (V)	V _{CEO} (V)	I _C (A)	TYPE		V _{CEsat} @ (V)	I _C (A)	I _B (mA)	t _s (μs)	t _f (μs)	R _{thj-c} (°C/W)	Case	Page
			NPN	PNP								
60	80	10	BDY92		0.50	5.00	500	1.3	0.2	2.5	TO - 3	241
60	120	50	BUV18		0.60	40.00	4000	1.1	0.3	0.7	TO - 3	425
80	100	10	BDY91		0.50	5.00	500	1.3	0.2	2.5	TO - 3	241
80	160	50	BUV19		0.60	30.00	3000	1.1	0.25	0.7	TO - 3	425
100	120	10	BDY90		0.50	5.00	500	1.3	0.2	2.5	TO - 3	241
120	60	5	2N4895		1.00	5.00	500	0.35	0.3	25	TO - 39	1059
120	60	5	2N4896		1.00	5.00	500	0.35	0.3	25	TO - 39	1059
120	60	30	BUW38		0.60	20.00	2000	1.1	0.39	1.17	TO - 3	583
120	60	30	BUW48		0.60	20.00	2000	1.1	0.25	1	TO - 218	601
120	75	20	2N5039		1.00	10.00	1000	1.5	0.5	1.25	TO - 3	1067
120	80	25	BDY57		1.40	10.00	1000	1.5	0.5	1	TO - 3	239
120	90	30	2N5671		0.75	15.00	1200	1.5	0.5	1.25	TO - 3	1107
120	90	50	2N6032		1.30	50.00	5000	1.5	0.5	1.25	TO - 3	1127
120	120	1.5	BSW67		1.00	1.00	150	0.7●	0.22●	35	TO - 39	251
130	60	6	BU125		1.00	5.00	500			15	TO - 39	255
140	90	7	2N6702		0.80	5.00	500	1	0.5	2.5	TO - 220	1179
150	80	5	2N4897		1.00	5.00	500	0.35	0.3	25	TO - 39	1059
150	90	20	2N5038		1.00	12.00	1200	1.5	0.5	1.25	TO - 3	1067
150	120	7	BUY47		1.00	5.00	500	0.7	0.04	15	TO - 39	785
150	120	30	2N5672		0.75	15.00	1200	1.5	0.5	1.25	TO - 3	1107
150	120	30	2N6033		1.00	40.00	4000	1.5	0.5	1.25	TO - 3	1127
150	125	120	ESM2012D(V)		1.5#	70	250	2▲	0.4▲	0.7	ISOTOP	*
150	150	1.5	BSW68		1.00	1.00	150	0.7●	0.22●	35	TO - 39	251
160	80	30	BUW39		0.50	15.00	1500	1.1	0.39	1.17	TO - 3	583
160	80	30	BUW49		0.50	15.00	1500	1.1	0.25	1	TO - 218	601
160	90	25	BUV39		1.20	20.00	2500	1	0.25	1.46	TO - 3	459
160	90	25	BUW89		0.90	15.00	1500	1	0.25	1.2	TO - 218	633
160	125	20	BUX40		1.20	10.00	1000	1	0.4	1.46	TO - 3	715
160	125	25	BDY58		1.40	10.00	1000	1.5	0.5	1	TO - 3	239
160	125	25	BUX10		0.60	10.00	1000	1.2	0.3	1.17	TO - 3	665
160	125	25	BUX10P		0.60	10.00	1000	1.2	0.3	1.17	TO - 218	669
160	125	50	BUV20		0.60	25.00	2500	1.2	0.25	0.7	TO - 3	433
160	125	50	BUX20		0.60	25.00	2500	1.2	0.3	0.5	TO - 3	687
160	140	25	BU999		0.80	10.00	1000	1.5	0.25	1.17	TO - 218	347
180	90	14	BUV26		0.60	6.00	600	1	0.25	1.76	TO - 220	441
200	125	4	D44Q1		1.00	2.00	200	2	1.7	4	TO - 220	805
200	125	16	BUT60		0.90	12.00	600	1.5▲	0.2▲	1	TO - 220	*
200	125	40	BUT70		0.90	35.00	1750	1.8▲	0.2▲	0.63	TO - 218	*
200	125	50	BUR20		1.00	25.00	2000			0.7	TO - 3	361
200	125	50	BUT100		0.90	50.00	2500	2▲	0.2▲	0.58	TO - 3	417
200	125	50	BUT90		0.90	35.00	1750	1.5	0.4	0.7	TO - 3	991
200	125	70	BUR50		1.00	35.00	2000	2	0.5	0.5	TO - 3	367
200	125	70	BUR50S		1.00	35.00	2000	2	0.5	0.5	TO - 3	367
200	125	100	BUT30(V)		0.9	100	10000	2▲	0.2▲	0.5	ISOTOP	*
200	125	200	BUT230(V)		0.9	200	20000	2▲	0.2▲	0.41	ISOTOP	*

▲ Inductive load

● Typical value

T_j = 125°C

■ T_j = 100°C

* Datasheet available on request

SWITCHING TRANSISTORS (cont'd)

V _{CEO} (V)	V _{CE0} (V)	I _C (A)	TYPE		V _{CEsat} (V)	I _C (A)	I _B (mA)	t _s (μs)	t _f (μs)	R _{thj-c} (°C/W)	Case	Page
			NPN	PNP								
200	170	7	BUY48		1.00	5.00	500	0.7	0.04●	15	TO - 39	785
200	200	1		2N5415	2.50	0.05	5	0.3	0.2	17.5	TO - 39	1093
200	200	3	BU325		1.50	0.50	50	0.75●	0.20●	5	SOT - 32	227
220	160	18	BUX41N		1.20	8.00	800	1.5	0.8	1.46	TO - 3	723
220	160	20	BUX11N		0.60	8.00	800	1.5	0.5	1.17	TO - 3	675
240	120	12	BUV27		0.70	4.00	400	1.2	0.25	1.76	TO - 220	447
250	125	20	BUV40		0.90	11.00	1100	1	0.3	1.46	TO - 3	467
250	125	20	BUW90		0.90	11.00	1100	1	0.3	1.2	TO - 218	641
250	125	25	BUV50		0.90	20.00	2000	1.2	0.3	1.17	TO - 3	497
250	125	25	BUW50		0.90	20.00	2000	1.2	0.3	1	TO - 218	607
250	125	50	BUV60		0.90	50.00	5000	1.1	0.2	0.7	TO - 3	529
250	150	3	BU125S		1.50	0.50	50			17.5	TO - 39	259
250	175	4	D44Q3		1.00	2.00	200	2	1.7	4	TO - 220	805
250	200	3	BUY49P		0.20	0.50	50	0.75	0.20	8.33	SOT - 32	789
250	200	3	BUY49S		0.20	0.50	50	0.75	0.30	17.5	TO - 39	791
250	200	15	BUX41		1.20	4.00	400	1.7	0.8	1.46	TO - 3	719
250	200	20	BUX11		0.60	6.00	600	1.8	0.4	1.17	TO - 3	671
250	200	40	BUV21		0.60	12.00	1200	1.8	0.4	0.7	TO - 3	433
250	200	40	BUX21		0.60	12.00	1200	1.8	0.4	0.5	TO - 3	691
275	250	0.5	2N5655		1.00	0.10	10			6.25	SOT - 32	1103
275	250	0.5	BD157							6.25	SOT - 32	141
300	200	15	BUV41		0.90	6.00	600	1.2	0.3	1.46	TO - 3	475
300	200	15	BUW91		0.90	6.00	600	1.2	0.3	1.2	TO - 218	647
300	200	20	BUV51		0.90	10.00	1000	1.4	0.3	1.17	TO - 3	505
300	200	20	BUW51		0.90	10.00	1000	1.4	0.3	1	TO - 218	617
300	200	40	BUR21		0.60	12.00	1200				TO - 3	363
300	200	50	BUT91		1.20	40.00	4000	1.2	0.3	0.7	TO - 3	397
300	200	50	BUV61		0.90	25.00	2500	1.2	0.3	0.7	TO - 3	537
300	200	60	BUR51		1.00	30.00	2000	2	0.6	0.5	TO - 3	371
300	225	4	D44Q5		1.00	2.00	200	2	1.7	4	TO - 220	805
300	250	1	2N3440		0.50	0.05	4			17.5	TO - 39	1043
300	250	12	BUX42		1.20	4.00	400	2	1.2	1.46	TO - 3	727
300	250	20	BUX12		1.00	5.00	500	2	0.5	1.17	TO - 3	679
300	250	40	BUV22		1.00	10.00	1000	2	0.5	0.7	TO - 3	433
300	250	40	BUX22		1.00	10.00	1000	2	0.5	0.5	TO - 3	695
300	300	0.5	MJE340	MJE350						6	SOT - 32	837
300	300	0.5	MJE340T	MJE350T						6	TO - 220	837
300	300	0.5	SGS340	SGS350						6	SOT - 82	837
325	300	0.5	2N5656		1.00	0.10	10			6.25	SOT - 32	1103
325	300	0.5	BD158							6.25	SOT - 32	141
330	150	7	BU407		1.00	5.00	500	0.9●	0.3●	2.08	TO - 220	297
330	150	7	BU407D		1.00	5.00	650	0.9●	0.3●	2.08	TO - 220	291
330	150	8	BU189		1.50	5.00	50	0.5	0.44●	2.08	TO - 220	263
330	150	8	BU807		1.50	5.00	50	0.55●	0.2●	2.08	TO - 220	311
330	150	8	BU807FI		1.50	5.00	50	0.55●	0.2●	2.08	ISOWATT220	311

● Typical value

SWITCHING TRANSISTORS (cont'd)

V _{CE0} (V)	V _{CEO} (V)	I _c (A)	TYPE		V _{CEsat} @ (V)	I _c (A)	I _B (mA)	t _s (μs)	t _f (μs)	R _{thj-c} (°C/W)	Case	Page
			NPN	PNP								
350	250	0.3	MJE3440		0.50	0.05	4			8.33	SOT - 32	855
350	250	0.3	SGS3440		0.50	0.05	4			8.33	SOT - 82	855
350	250	1	TIP47		1.00	1.00	200	1.2●	0.45●	3.12	TO - 220	1005
350	250	5	2N6497		1.00	2.50	500	1.8	0.8	1.56	TO - 220	1159
350	250	5	TIP51		1.50	3.00	600	2.5●	0.2●	1.25	TO - 218	1009
350	250	12	BUV42		0.90	4.00	400	1.6	0.3	1.46	TO - 3	483
350	250	12	BUW92		0.80	2.00	130	1.6	0.3	1.2	TO - 218	657
350	250	20	BUV52		0.90	8.00	800	1.6	0.3	1.17	TO - 3	513
350	250	20	BUW52		0.80	4.00	260	1.6	0.3	1	TO - 218	625
350	250	40	BUR22		1.00	10.00	1000				TO - 3	365
350	250	40	BUV62		0.90	16.00	1600	1.8	0.35	0.7	TO - 3	545
350	250	50	BUT92		1.20	35.00	3500	3▲	0.4▲	0.7	TO - 3	405
350	250	60	BUR52		1.80	25.00	2000	2	0.6	0.5	TO - 3	375
350	300	1		2N5416	2.50	0.05	5	0.3	0.2	17.5	TO - 39	1093
375	350	0.5	2N5657		1.00	0.10	10			6.25	SOT - 32	1103
375	350	0.5	BD159							6.25	SOT - 32	141
400	200	7	BU406		1.00	5.00	500	0.9●	0.3●	2.08	TO - 220	285
400	200	7	BU406D		1.00	5.00	650	0.9●	0.3●	2.08	TO - 220	291
400	200	8	BU184		1.50	5.00	50	0.5	0.44●	2.08	TO - 220	263
400	200	8	BU806		1.50	5.00	50	0.55●	0.2●	2.08	TO - 220	305
400	200	8	BU806FI		1.50	5.00	50	0.55●	0.22●	4.16	ISOWATT220	311
400	200	10	BUV28		1.50	6.00	600	1.5	0.25	1.76	TO - 220	453
400	300	1	TIP48		1.00	1.00	200	1.3●	0.45●	3.12	TO - 220	1005
400	300	5	2N6498		1.25	2.50	500	1.8	0.8	1.56	TO - 220	1159
400	300	5	TIP52		1.50	3.00	600	2.5●	0.2●	1.25	TO - 218	1009
400	300	12	BUV42A		0.90	4.00	400	3▲	0.4▲	1.46	TO - 3	491
400	300	16	BUT62		0.90	10.00	1000	2.2▲	0.4▲	1	TO - 220	*
400	300	20	BUV52A		0.90	7.00	700	3▲	0.4▲	1.17	TO - 3	521
400	300	40	BUT72		0.90	30.00	3000	3▲	0.4▲	0.63	TO - 218	*
400	300	40	BUV62A		0.90	15.00	1500	3▲	0.4▲	0.7	TO - 3	553
400	300	50	BUT102		0.90	40.00	4000	3▲	0.4▲	0.7	TO - 3	421
400	300	50	BUT92A		0.90	30.00	3000	3▲	0.4▲	0.7	TO - 3	411
400	300	67	ESM2030D(V)		2.0#	56	1600	3.5▲■	0.7▲■	0.83	ISOTOP	*
400	300	80	BUT32(V)		0.9	40	4000	3▲■	0.4▲■	0.5	ISOTOP	*
400	300	100	ESM3030D(V)		1.7#	60	600	3.5▲■	0.7▲■	0.83	ISOTOP	*
400	325	10	BUX43		2.00	5.00	1000	2.2	1.2	1.46	TO - 3	731
400	325	15	BUX13		1.50	8.00	1600	3	1.2	1.17	TO - 3	683
400	325	30	BUV23		1.00	16.00	3200	2.5	1.2		TO - 3	437
400	325	30	BUX23		1.00	16.00	3200	2.5	1.2	0.5	TO - 3	699
400	350	6		BUW22P	1.50	2.50	1000	1.5	0.7	2	TO - 220	563
400	350	10		BUW32	1.50	5.00	1500	1.5	0.6	1.2	TO - 3	569
400	350	10		BUW32P	1.50	5.00	1500	1.5	0.6	1.2	TO - 218	569
400	350	10		BUW32PFI	1.50	5.00	1500	1.5	0.6	2.27	ISOWATT218	569
400	350	15		BUW42	1.50	10.00	3000	1.5	0.6	1	TO - 3	593
400	350	15		BUW42P	1.50	10.00	3000	1.5	0.6	1.2	TO - 218	593

▲ Inductive load

● Typical value

* Datasheet available on request

SWITCHING TRANSISTORS (cont'd)

V _{CB0} (V)	V _{CEO} (V)	I _C (A)	TYPE		V _{CEsat} @ (V)	I _C (A)	I _B (mA)	t _s (μs)	t _f (μs)	R _{thj-c} (°C/W)	Case	Page
			NPN	PNP								
400	350	15		BUW42PFI	1.50	10.00	3000	1.5	0.6	1.92	ISOWATT218	593
400	350	20	MJ10004		1.90	10.00	400	1.5	0.5	1	TO - 3	823
400	350	20	MJ10004P		1.90	10.00	400	1.5	0.5	1	TO - 218	823
400	350	20	MJ10004PFI		1.90	10.00	400	1.5	0.5	2.08	ISOWATT218	823
450	300	8	2N6671		1.00	5.00	1000	2.5	0.4	1.17	TO - 3	1167
450	300	8	2N6928		1.00	8.00	1600	2.5	0.4	1.25	TO - 220	*
450	300	10	2N6931		1.00	10.00	2000	2.5	0.5	0.83	TO - 218	1181
450	300	15	2N6674		1.00	10.00	2000	2.5	0.5	1	TO - 3	1171
450	300	15	2N6676		1.00	15.00	3000	2.5	0.5	1	TO - 3	1175
450	300	15	2N6933		1.00	15.00	3000	2.5	0.5	0.71	TO - 218	1185
450	350	0.3	MJE3439		0.50	0.05	4			8.33	SOT - 32	855
450	350	0.3	SGS3439		0.50	0.05	4			8.33	SOT - 82	855
450	350	1	2N3439		0.50	0.05	4			17.5	TO - 39	1043
450	350	1	TIP49		1.00	1.00	200	1.3●	0.45●	3.12	TO - 220	1005
450	350	5	2N6499		1.50	2.50	500	1.8	0.8	1.56	TO - 220	1159
450	350	5	TIP53		1.50	3.00	600	2.5●	0.2●	1.25	TO - 218	1005
450	400	6		BUW22AP	1.50	2.50	1000	1.5	0.7	2	TO - 220	563
450	400	8	BUX44		1.50	4.00	800	2.5	1.2	1.46	TO - 3	733
450	400	10		BUW32A	1.50	5.00	1500	1.5	0.6	1.2	TO - 3	569
450	400	10		BUW32AP	1.50	5.00	1500	1.5	0.6	1.2	TO - 218	569
450	400	10		BUW32APFI	1.50	5.00	1500	1.5	0.6	2.27	ISOWATT218	569
450	400	10	BUX14		1.60	6.00	1200	3	1.2	1.17	TO - 3	685
450	400	15		BUW42A	1.50	10.00	3000	1.5	0.6	1	TO - 3	593
450	400	15		BUW42AP	1.50	10.00	3000	1.5	0.5	1.2	TO - 218	593
450	400	15		BUW42APFI	1.50	10.00	3000	1.5	0.6	1.92	ISOWATT218	593
450	400	20	BUV24		1.00	12.00	2400	3	1.4	0.7	TO - 3	437
450	400	20	BUX24		1.00	12.00	2400	3	1.4	0.7	TO - 3	705
450	400	20	MJ10005		1.90	10.00	400	1.5	0.5	1	TO - 3	823
450	400	20	MJ10005P		1.90	10.00	400	1.5	0.5	1	TO - 218	823
450	400	20	MJ10005PFI		1.90	10.00	400	1.5	0.5	2.08	ISOWATT218	823
500	200	10	BUY69C		3.3	8.00	2500	1.7●	0.3●	1.75	TO - 3	799
500	400	1	TIP50		1.00	1.00	200	1.3●	0.45●	3.12	TO - 220	1005
500	400	5	TIP54		1.50	3.00	600	2.5●	0.2●	1.25	TO - 218	1009
500	400	10	BUW34		1.50	5.00	1000	3	0.8	1.4	TO - 3	575
500	400	15	BUW44		3.00	10.00	2000	3	0.8	1	TO - 3	597
500	500	15	BUV25		1.00	8.00	1600	5	1.6	0.7	TO - 3	437
500	500	30	BUX25		1.00	8.00	1600	5	1.2	0.5	TO - 3	711
550	350	8	2N6672		1.00	5.00	1000	2.5	0.4	1.17	TO - 3	1167
550	350	8	2N6929		1.00	8.00	1600	2.5	0.4	1.25	TO - 220	*
550	350	15	2N6677		1.00	15.00	3000	2.5	0.5	1	TO - 3	1175
550	350	15	2N6934		1.00	15.00	3000	2.5	0.5	0.71	TO - 218	1185
600	300	1.5	SGS13002		1.00	1.00	250	2.5	0.5	2.5	SOT - 82	877
600	300	1.5	SGS13002T		1.00	1.00	250	2.5	0.5	2.5	TO - 220	877
600	300	4	MJE13004		1.00	4.00	1000	4	0.9	1.67	TO - 220	859
600	300	8	MJE13006		1.50	5.00	1000	3	0.7	1.56	TO - 220	863

● Typical value

* Datasheet available on request

SWITCHING TRANSISTORS (cont'd)

V _{CB0} (V)	V _{CEO} (V)	I _C (A)	TYPE		V _{CEsat} @		I _B (mA)	t _s (μs)	t _f (μs)	R _{thj-c} (°C/W)	Case	Page
			NPN	PNP	(V)	(A)						
600	300	12	MJE13008		1.50	8.00	1600	3	0.7	1.25	TO - 220	871
600	400	3	BU801		2.20	1.00	15	1	0.5	3.12	SOT - 32	307
600	400	7	BU810		2.50	4.00	200	1.5	0.5	1.66	TO - 220	321
600	400	28	BUT13		2.00	10.00	500	1.5	0.6	1	TO - 3	385
600	400	28	BUT13P		2.00	10.00	500	1.5	0.6	1	TO - 218	385
600	400	28	BUT13PFI		2.00	10.00	500	1.5	0.6	2.08	ISOWATT218	385
600	400	28	SGSD310		2.50	18.00	1800	1.5	0.5	1	TO - 3	889
600	400	28	SGSD311		2.50	18.00	1800	1.5	0.5	1	TO - 218	889
600	400	28	SGSD311FI		2.50	18.00	1800	1.5	0.5	2.08	ISOWATT218	889
600	450	24	ESM3045D(V)		2.0#	15	300	4▲	0.4▲	1	ISOTOP	*
600	450	42	ESM4045D(V)		2.0#	25	500	4.5▲	0.5▲	0.83	ISOTOP	*
600	450	60	ESM5045D(V)		2.0#	35	700	5▲	0.5▲	0.71	ISOTOP	*
600	450	75	ESM7545D(V)		2.5	75	1500	5▲	1▲	0.41	ISOTOP	*
600	450	84	ESM6045D(V)		2.0#	50	1000	5.5▲	0.5▲	0.5	ISOTOP	*
650	300	8	2N6544		1.5	5.00	1000	4	0.9	1.4	TO - 3	1163
650	400	8	2N6673		1.00	5.00	1000	2.5	0.4	1.17	TO - 3	1167
650	400	8	2N6930		1.00	8.00	1600	2.5	0.4	1.25	TO - 220	*
650	400	8	SGSD00020		4.00	3.00	3				TO - 220	895
650	400	10	2N6932		1.00	10.00	2000	2.5	0.5	0.83	TO - 218	1181
650	400	15	2N6675		1.00	10.00	2000	2.5	0.5	1	TO - 3	1171
650	400	15	2N6678		1.00	15.00	3000	2.5	0.5	1	TO - 3	1175
650	400	15	2N6935		1.00	15.00	3000	2.5	0.5	0.71	TO - 218	1185
650	400	28	SGSD00030		2.50	12.00	100	1.5	0.5	1	TO - 218	897
650	400	28	SGSD00030FI		2.50	12.00	100	1.5	0.5	2.08	ISOWATT218	897
650	400	28	SGSD00031		2.50	12.00	100	1.5	0.5	1	TO - 3	897
700	400	1.5	SGS13003		1.0	1.00	250	2.5	0.5	2.5	SOT - 82	877
700	400	1.5	SGS13003T		1.0	1.00	250	2.5	0.5	2.5	TO - 220	877
700	400	4	MJE13005		1.0	4.00	1000	4	0.9	1.67	TO - 220	859
700	400	8	MJE13007		1.5	5.00	1000	3	0.7	1.56	TO - 220	863
700	400	12	MJE13009		1.5	8.00	1600	3	0.7	1.25	TO - 220	871
800	325	10	BUY69B		3.3	8.00	2500	1.7●	0.3●	1.75	TO - 3	799
800	375	6	BU426		1.5	2.50	500	3.5	0.5	1.16	TO - 218	303
800	375	6	BU426FI		1.5	2.50	500	3.5	0.5	2.5	ISOWATT218	303
800	400	2	BUX84		3.0	1.00	200	3.5	0.4●	3.12	TO - 220	765
800	400	10	BUW35		1.50	5.00	1000	3	0.8	1.4	TO - 3	575
800	400	10	BUX80		1.5	5.00	1000	3.5	0.5	1.75	TO - 3	761
800	400	15	BUW45		1.50	10.00	2000	3	0.8	1	TO - 3	597
800	500	20	MJ13335		1.8	10.00	2000				TO - 3	*
850	400	5	BUT11		1.5	3.00	600	4	0.8	1.5	TO - 220	379
850	400	5	BUT11FI		1.5	3.00	600	4	0.8	3.57	ISOWATT220	379
850	400	5	BUV46		1.5	2.50	500	3	0.8	1.76	TO - 220	495
850	400	5	BUV46FI		1.5	2.50	500	3	0.8	4.16	ISOWATT220	495
850	400	5	SGSF321		1.5	3.50	700	2.5	0.3	1.78	TO - 220	907
850	400	5	SGSF421		1.5	3.50	700	2.5	0.3	1.56	TO - 218	907
850	400	5	SGSIF321		1.5	3.50	700	2.5	0.3	3.57	ISOWATT220	907

▲ Inductive load

● Typical value

T_j = 125°C

■ T_j = 100°C

* Datasheet available on request

SELECTION GUIDE BY VOLTAGE

SWITCHING TRANSISTORS (cont'd)

V _{CEO} (V)	V _{CE0} (V)	I _C (A)	TYPE		V _{CEsat} @ (V)	I _C (A)	I _B (mA)	t _s (μs)	t _f (μs)	R _{thj-c} (°C/W)	Case	Page
			NPN	PNP								
850	400	5	SGSIF421		1.5	3.50	700	2.5	0.3	2.77	ISOWATT218	907
850	400	8	2N6545		1.5	5.00	1000	4	0.9	1.4	TO - 3	1163
850	400	8	BUW12		1.5	6.00	1200	4	0.8	1.2	TO - 218	561
850	400	8	MJE13007A		1.5	5.00	1000	3	0.7	1.56	TO - 220	863
850	400	9	BUV47		1.5	6.00	1200	2.5	0.8	1.25	TO - 218	735
850	400	9	BUV47FI		1.5	6.00	1200	2.5	0.8	2.27	ISOWATT218	735
850	400	9	BUX47		1.5	6.00	1200	2.5	0.8	1.2	TO - 3	735
850	400	10	BUT12FI		1.5	6.00	1200				ISOWATT220	*
850	400	10	SGSF341		1.5	6.00	1200	2.5	0.3	1.47	TO - 220	931
850	400	10	SGSF441		1.5	6.00	1200	2.5	0.3	1.31	TO - 218	931
850	400	10	SGSF541		1.5	6.00	1200	2.5	0.35	1.3	TO-3	931
850	400	10	SGSIF341		1.5	6.00	1200	2.5	0.3	3.12	ISOWATT220	931
850	400	10	SGSIF441		1.5	6.00	1200	2.5	0.3	2.27	ISOWATT218	931
850	400	15	BUV48		1.5	10.00	2000	3	0.8	1	TO - 218	745
850	400	15	BUV48FI		1.5	10.00	2000	3	0.8	1.92	ISOWATT218	745
850	400	15	BUX48		1.5	10.00	2000	3	0.8	1	TO - 3	745
850	400	15	SGSF461		1.5	10.00	2000	2.3	0.5	1	TO - 218	955
850	400	15	SGSF561		1.5	10.00	2000	2.3	0.5	1	TO - 3	955
850	400	15	SGSIF461		1.5	10.00	2000	2.3	0.5	1.92	ISOWATT218	955
850	400	30	BUX98		1.5	20.00	4000	3	0.8	0.7	TO - 3	767
850	400	30	SGSF661		1.5	20.00	4000	2.3	0.5	0.6	TO - 3	979
850	450	7.5	BUF405		0.5●	5.00	1000				TO - 220	349
850	450	8	MJH16006		3.0	5.00	660				TO - 218	*
850	450	8	MJH16008		3.0	5.00	500				TO - 218	*
850	450	9	BUV56		1.2	5.00	1000	3▲	0.4▲	1.76	TO - 220	525
850	450	15	BUF410		0.5●	10.00	2000				TO - 218	353
850	450	15	BUF410I		0.5●	10.00	2000				TOP - 3I	353
850	450	15	BUV66		1.2	8.00	1600	3▲	0.4▲	1.25	TO - 220	557
850	450	15	MJH16010		3.0	10.00	1300				TO - 218	*
850	450	15	MJH16012		3.0	10.00	1000				TO - 218	*
850	450	30	BUF420		0.5●	20.00	4000				TO - 218	357
850	450	30	BUF420I		0.5●	20.00	4000				TOP - 3I	357
850	450	30	BUF420M		0.5●	20.00	4000				TO - 3	357
850	450	30	BUX98P		0.9	20.00	4000	3	0.8	0.63	TO - 218	773
850	450	30	BUV98(V)		1.5	20	4000	5▲	0.4▲	0.83	ISOTOP	*
850	450	45	BUX348		0.9	30.00	6000			0.58	TO - 3	779
850	450	60	BUV298(V)		1.2	40	8000	4.5▲	0.4▲	0.5	ISOTOP	*
850	450	90	BUF460(V)		2.0#	60	12000	3.5▲	0.12▲	0.41	ISOTOP	*
900	400	6	BU326A		1.5	2.50	500	3.5	0.5	2.33	TO - 3	281
900	400	6	BU426A		1.5	2.50	500	3.5	0.5	1.1	TO - 218	303
900	400	6	BU426AFI		1.5	2.50	500	3.5	0.5	2.5	ISOWATT218	303
900	450	10	BUW36		1.5	5.00	1000	3	0.8	1.4	TO - 3	575
900	450	15	BUW46		1.5	10.00	2000	3	0.8	1	TO - 3	597
1000	400	7	SGSD00055		2.5	3.00	200	0.8	0.15	1.66	TO - 220	905
1000	400	10	BUY69A		3.3	8.00	2500	1.7●	0.3●	1.75	TO - 3	799

▲ Inductive load

● Typical value

T_j = 125°C

■ T_j = 100°C

* Datasheet available on request

SWITCHING TRANSISTORS (cont'd)

V _{CBO} (V)	V _{CEO} (V)	I _C (A)	TYPE		V _{CEsat} @		I _B (mA)	t _s (μs)	t _f (μs)	R _{th-jc} (°C/W)	Case	Page
			NPN	PNP	(V)	(A)						
1000	450	2	BUX85		1.0	1.00	200	3.5	0.4●	2.5	TO - 220	*
1000	450	5	BUT11A		1.5	2.50	500	4	0.8	1.5	TO - 220	379
1000	450	5	BUT11AFI		1.5	2.50	500	4	0.8	3.57	ISOWATT220	379
1000	450	5	BUV46A		1.5	2.00	400	3	0.8	1.76	TO - 220	495
1000	450	5	BUV46AFI		1.5	2.00	400				ISOWATT220	495
1000	450	5	SGSF323		1.5	2.50	500	2.5	0.3	1.78	TO - 220	913
1000	450	5	SGSF423		1.5	2.50	500	2.5	0.3	1.56	TO - 218	913
1000	450	5	SGSIF323		1.5	2.50	500	2.5	0.3	3.57	ISOWATT220	913
1000	450	5	SGSIF423		1.5	2.50	500	2.5	0.3	2.77	ISOWATT218	913
1000	450	7.5	BUF405A		0.5●	5.00	1000				TO - 220	349
1000	450	8	BUW12A		1.5	6.00	1200	4	0.8	1.2	TO - 218	561
1000	450	8	SGSF343		1.5	4.50	900	2.5	0.35	1.47	TO - 220	937
1000	450	8	SGSF443		1.5	4.50	900	2.5	0.35	1.31	TO - 218	937
1000	450	8	SGSF543		1.5	4.50	900	2.5	0.35	1.3	TO - 3	937
1000	450	8	SGSIF343		1.5	4.50	900	2.5	0.35	3.12	ISOWATT220	937
1000	450	8	SGSIF443		1.5	4.50	900	2.5	0.35	2.27	ISOWATT218	937
1000	450	9	BUV47A		1.5	5.00	1000	3	0.8	1.25	TO - 218	735
1000	450	9	BUV47AFI		1.5	5.00	1000	3	0.8	2.27	ISOWATT218	735
1000	450	9	BUX47A		1.5	5.00	1000	2.5	0.8	1.2	TO - 3	735
1000	450	10	BUT12AFI		1.5	5.00	1000				ISOWATT220	*
1000	450	12	SGSF463		1.5	7.00	1400	2.3	0.5	1	TO - 218	961
1000	450	12	SGSF563		1.5	7.00	1400	2.3	0.5	1	TO - 3	961
1000	450	12	SGSIF463		1.5	7.00	1400	2.3	0.5	1.92	ISOWATT218	961
1000	450	15	BUF410A		0.5●	10.00	2000				TO - 218	353
1000	450	15	BUF410AI		0.5●	10.00	2000				TOP - 3I	353
1000	450	15	BUV48A		1.5	8.00	1600	3	0.8	1	TO - 218	745
1000	450	15	BUV48AFI		1.5	8.00	1600	3	0.8	1.92	ISOWATT218	745
1000	450	15	BUX48A		1.5	8.00	1600	3	0.8	1	TO - 3	745
1000	450	24	ESM3045A(V)		2.0#	18	720	4.5■	0.5■	1	ISOTOP	*
1000	450	24	SGSF663		1.5	14.00	2800	2.3	0.5	0.6	TO - 3	983
1000	450	30	BUF420A		0.5●	20.00	4000				TO - 218	357
1000	450	30	BUF420AI		0.5●	20.00	4000				TOP - 3I	357
1000	450	30	BUF420AM		0.5●	20.00	4000				TO - 3	357
1000	450	30	BUV98A(V)		1.5	16	3200	5■	0.4■	0.83	ISOTOP	*
1000	450	30	BUX98A		1.5	16.00	3200	3	0.8	0.7	TO - 3	767
1000	450	42	ESM4045A(V)		2.0#	30	1200	5■	0.6■	0.83	ISOTOP	*
1000	450	50	BUV298A(V)		1.2	32	6400	4.5■	0.4■	0.5	ISOTOP	*
1000	450	84	ESM6045A(V)		2.0#	60	2400	6■	0.6■	0.5	ISOTOP	*
1000	450	90	BUF460A(V)		2.0#	60	12000	3.5■	0.12■	0.41	ISOTOP	*
1000	700	50	ESMT5070D(V)		3.0	50	500	15■	3■	0.41	ISOTOP	*
1000	500	5	2ST3679FI		0.5	2.00	400				ISOWATT218	*
1000	550	6	2ST3153		2.0	3.00	600				TO - 218	*
1200	600	4	SGSF324		1.5	1.75	350	4.5	0.35	1.78	TO - 220	919
1200	600	4	SGSF424		1.5	1.75	350	4.5	0.35	1.56	TO - 218	919
1200	600	4	SGSIF324		1.5	1.75	350	4.5	0.35	3.57	ISOWATT220	919

▲ Inductive load

● Typical value

T_J = 125°C■ T_J = 100°C

* Datasheet available on request

SELECTION GUIDE BY VOLTAGE

SWITCHING TRANSISTORS (cont'd)

V _{CEO} (V)	V _{CE0} (V)	I _C (A)	TYPE		V _{CEsat} @ (V)	I _C (A)	I _B (mA)	t _s (μs)	t _f (μs)	R _{thj-c} (°C/W)	Case	Page
			NPN	PNP								
1200	600	4	SGSIF424		1.5	1.75	350	4.5	0.35	2.77	ISOWATT218	919
1200	600	6	2ST3642		5.0	4.00	800				TO - 218	*
1200	600	7	SGSF344		1.5	3.50	700	3.5	0.3	1.47	TO - 220	344
1200	600	7	SGSF444		1.5	3.50	700	3.5	0.3	1.31	TO - 218	943
1200	600	7	SGSF544		1.5	3.50	700	3.5	0.3	1.3	TO - 3	943
1200	600	7	SGSIF344		1.5	3.50	700	3.5	0.3	3.12	ISOWATT220	943
1200	600	7	SGSIF444		1.5	3.50	700	3.5	0.3	2.27	ISOWATT218	943
1200	600	8	2ST3412		5.0	5.00	1000				TO - 3	*
1200	600	10	SGSF464		1.5	6.00	1200	3.5	0.4	1	TO - 218	967
1200	600	10	SGSF564		1.5	6.00	1200	3.5	0.4	1	TO - 3	967
1200	600	10	SGSIF464		1.5	6.00	1200	3.5	0.4	1.92	ISOWATT218	967
1200	600	12	2ST3552		2.0	6.00	1200				TO - 218	*
1200	600	15	BUV48B		1.5	6.00	1500	3	0.7	1	TO - 218	755
1200	600	15	BUV48BFI		1.5	6.00	1500	3	0.7	1.92	ISOWATT218	755
1200	600	15	BUX48B		1.5	6.00	1500	3	0.7	1	TO - 3	755
1200	600	20	SGSF664		1.5	12.00	2400	3.5	0.4	0.6	TO - 3	987
1200	600	30	BUX98B		1.5	12.00	3000	3	0.8	0.7	TO - 3	769
1200	700	15	BUV48C		1.5	6.00	1500	3	0.7	1	TO - 218	755
1200	700	15	BUV48CFI		1.5	6.00	1500	3	0.7	1.92	ISOWATT218	755
1200	700	15	BUX48C		1.5	6.00	1500	3	0.7	1	TO - 3	755
1200	700	30	BUV98C(V)		1.5	12	3000	6▲#	0.6▲#	0.83	ISOTOP	*
1200	700	30	BUX98C		1.5	12.00	3000	3	0.8	0.7	TO - 3	769
1300	500	8	2SC3412		5.0	5.00	1000				TO - 3	*
1300	600	4	SGSF425		1.5	1.25	250	4.5	0.35	1.56	TO - 218	925
1300	600	4	SGSIF425		1.5	1.25	250	4.5	0.35	2.77	ISOWATT218	925
1300	600	7	SGSF445		1.5	3.00	600	3.5	0.3	1.31	TO - 218	949
1300	600	7	SGSIF445		1.5	3.00	600	3.5	0.3	2.27	ISOWATT218	949
1300	600	10	SGSF465		1.5	5.00	1000	3.5	0.4	1	TO - 218	973
1300	600	10	SGSF565		1.5	5.00	1000	3.5	0.4	1	TO - 3	973
1300	600	10	SGSIF465		1.5	5.00	1000	3.5	0.4	1.92	ISOWATT218	973
1300	600	20	SGSF665		1.5	10.00	2000	3.5	0.4	0.6	TO - 3	991
1400	700	10	BU808FI		1.6	5.00	500			2.5	ISOWATT218	317
1400	700	10	BU808DFI		1.6	5.00	500			2.5	ISOWATT218	317
1500	600	2.5	2SD1425FI		8.0	2.00	600				ISOWATT218	*
1500	600	2.5	2SD1429FI		8.0	2.00	600				ISOWATT218	*
1500	600	2.5	2SD818		8.0	2.00	600				TO - 3	*
1500	600	3.5	2SD819		8.0	3.00	800				TO - 3	*
1500	600	3.5	2SD869		8.0	3.00	800				TO - 3	*
1500	600	3.5	2SD1426FI		8.0	3.00	800				ISOWATT218	*
1500	600	3.5	2SD1430FI		8.0	3.00	800				ISOWATT218	*
1500	600	5	2SD1427FI		5.0	4.00	800				ISOWATT218	*
1500	600	5	2SD1431FI		5.0	4.00	800				ISOWATT218	*
1500	600	6	2SD1428FI		5.0	5.00	1000				ISOWATT218	*
1500	600	6	2SD1432FI		5.0	5.00	1000				ISOWATT218	*
1500	700	2.5	2ST1396		8.0	2.00	600				TO - 218	*

▲ Inductive load

T_j = 125°C

* Datasheet available on request

SWITCHING TRANSISTORS (cont'd)

V _{CB0} (V)	V _{CE0} (V)	I _C (A)	TYPE		V _{CEsat} @ (V)	I _C (A)	I _B (mA)	t _s (μs)	t _f (μs)	R _{thj-c} (°C/W)	Case	Page
			NPN	PNP								
1500	700	2.5	S2056FI		5.0	2.00	1000				ISOWATT218	*
1500	700	3	2SD1453		5.0	2.50	800				TO - 218	*
1500	700	3	2SD1910FI		5.0	2.50	800				ISOWATT218	*
1500	700	3	2ST1942		5.0	2.50	800				TO - 3	*
1500	700	3.5	2SD1650FI		8.0	2.50	800				ISOWATT218	*
1500	700	4	2SD1441		1.0	3.00	1000				TO - 218	*
1500	700	4	2ST1877FI		5.0	2.50	800				ISOWATT218	*
1500	700	5	2SD1455		5.0	4.50	1200				TO - 218	*
1500	700	5	2SD1577FI		2.0	4.50	2000				ISOWATT218	*
1500	700	5	2SD1730		8.0	4.00	1000				TO - 218	*
1500	700	5	2ST1651FI		5.0	4.00	800				ISOWATT218	*
1500	700	5	2ST3485		5.0	4.00	1000				TO - 218	*
1500	700	5	2ST34851FI		5.0	4.00	1000				ISOWATT218	*
1500	700	5	BU706		5.0	3.00	1330				TO - 218	305
1500	700	6	2ST3460		2.0	3.00	600				TO - 218	*
1500	700	7	2ST2000FI		1.0	4.00	2000				ISOWATT218	*
1500	700	7.5	2ST2000		1.0	4.00	2000				TO - 218	*
1500	700	7.5	S2000FI		5.0	4.50	2000				ISOWATT218	*
1500	700	8	2ST3461		2.0	4.00	800				TO - 218	*
1500	700	8	BU208		5.0	4.50	2000	7●	0.55●	1	TO - 3	267
1500	700	8	BU208A		1.0	4.50	2000	7●	0.55●	1	TO - 3	267
1500	700	8	BU208D		1.0	4.50	2000	7●	0.55●	1	TO - 3	271
1500	700	8	BU508		5.0	4.50	2000	7●	0.55●	1	TO - 218	267
1500	700	8	BU508A		1.0	4.50	2000	7●	0.55●	1	TO - 218	267
1500	700	8	BU508AFI		1.0	4.50	2000	7●	0.55●	2.08	ISOWATT218	267
1500	700	8	BU508D		1.0	4.50	2000	7●	0.55●	1	TO - 218	271
1500	700	8	BU508DFI		1.0	4.50	2000	7●	0.55●	2.08	ISOWATT218	271
1500	700	8	BU508FI		5.0	4.50	2000	7●	0.55●	2.08	ISOWATT218	267

● Typical value

* Datasheet available on request

SELECTION GUIDE BY PACKAGE

GENERAL PURPOSE TRANSISTORS

SOT-32

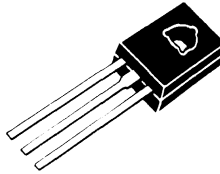

V_{CE0} (V)	V_{CBO} (V)	I_C (A)	TYPE	Complementary	h_{FE} @	I_C (A)	V_{CE} (V)	V_{CEsat} @	I_C (A)	I_B (mA)	R_{thj-c} (°C/W)	Page
22	22	4	BD433	BD434	50	2.00	1.0	0.50	2.00	200	3.5	163
25	40	5	MJE200	MJE210	70	0.50	1.0	0.30	0.50	50	8.34	833
30	30	3	MJE520	MJE370	25	1.00	1.0			5		841
32	32	4	BD435	BD436	50	2.00	1.0	0.50	2.00	200	3.5	163
40	40	1	2N4921	2N4918	30	0.50	1.0	0.60	1.00	100	4.16	1063
40	40	4	2N5190	2N5193	25	1.50	2.0	0.60	1.50	150	3.12	1077
40	40	4	2N6037	2N6034	500	0.50	3.0	2.00	2.00	8	3.12	1131
40	40	4	MJE521	MJE371	40	1.00	1.0				3.12	845
40	60	3	MJE180	MJE170	30	0.50	1.0	0.90	1.50	150	10	829
45	45	1.5	BD135	BD136	25	0.50	2.0	0.50	0.50	50	10	133
45	45	2	BD233	BD234	25	1.00	2.0	0.60	1.00	100	5	149
45	45	3	BD175	BD176	15	1.00	2.0	0.80	1.00	100	4.16	143
45	45	4	BD437	BD438	40	2.00	1.0	0.60	2.00	200	3.5	163
45	45	4	BD675	BD676	750	1.50	3.0	2.50	1.50	30	3.12	175
45	45	4	BD675A	BD676A	750	2.00	3.0	2.80	2.00	40	3.12	175
60	60	1	2N4922	2N4919	30	0.50	1.0	0.60	1.00	100	4.16	1063
60	60	1.5	BD137	BD138	25	0.50	2.0	0.50	0.50	50	10	133
60	60	2	BD235	BD236	25	1.00	2.0	0.60	1.00	100	5	149
60	60	3	BD177	BD178	15	1.00	2.0	0.80	1.00	100	4.16	143
60	60	4	2N5191	2N5194	25	1.50	2.0	0.60	1.50	150	3.12	1077
60	60	4	2N6038	2N6035	500	0.50	3.0	2.00	2.00	8	3.12	1131
60	60	4	BD439	BD440	25	2.00	1.0	0.80	2.00	200	3.5	169
60	60	4	BD677	BD678	750	1.50	3.0	2.50	1.50	30	3.12	175
60	60	4	BD677A	BD678A	750	2.00	3.0	2.80	2.00	40	3.12	175
60	60	4	MJE800	MJE700	750	1.50	3.0	3.00	4.00	40	3.12	849
60	60	4	MJE801	MJE701	750	2.00	3.0	3.00	4.00	40	3.12	849
60	80	3	MJE181	MJE171	30	0.50	1.0	0.90	1.50	150	10	829
80	80	1	2N4923	2N4920	30	0.50	1.0	0.60	1.00	100	4.16	1063
80	80	1.5	BD139	BD140	25	0.50	2.0	0.50	0.50	50	10	133
80	80	3	BD179	BD180	15	1.00	2.0	0.80	1.00	100	4.16	143
80	80	4	2N5192	2N5195	20	1.50	2.0	0.60	1.50	150	3.12	1077
80	80	4	2N6039	2N6036	500	0.50	3.0	2.00	2.00	8	3.12	1131
80	80	4	BD441	BD442	15	2.00	1.0	0.80	2.00	200	3.5	169
80	80	4	BD679	BD680	750	1.50	3.0	2.50	1.50	30	3.12	175
80	80	4	BD679A	BD680A	750	2.00	3.0	2.80	2.00	40	3.12	175

GENERAL PURPOSE TRANSISTORS (cont'd)

SOT-32 (cont'd)

V_{CE0} (V)	V_{CB0} (V)	I_C (A)	TYPE	Complement- ary	h_{FE} @ I_C (A)	V_{CE} (V)	V_{CEsat} @ I_C (V)	I_C (A)	I_B (mA)	R_{thj-c} (°C/W)	Page	
80	80	4	MJE802	MJE702	750	1.50	3.0	3.00	4.00	40	3.12	849
80	80	4	MJE803	MJE703	750	2.00	3.0	3.00	4.00	40	3.12	849
80	100	2	BD237	BD238	25	1.00	2.0	0.60	1.00	100	5	149
80	100	3	MJE182	MJE172	30	0.50	1.0	0.90	1.50	150	10	829
100	100	4	BD681	BD682	750	1.50	3.0	2.50	1.50	30	3.12	175

TO-39

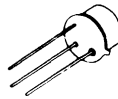

V_{CE0} (V)	V_{CB0} (V)	I_C (A)	TYPE	Complement- ary	h_{FE} @ I_C (A)	V_{CE} (V)	V_{CEsat} (V)	I_C (A)	I_B (mA)	R_{thj-c} (°C/W)	Page	
40	40	3		2N4234	20	0.50	1.0	0.60	1.00	100	29	1057
60	65	5		BSS44	40	2.00	2.0	1.00	5.00	500	35	247
60	100	5	BFX34		40	2.00	2.0	1.00	5.00	500	35	243
60	100	7	BUY68		40	1.00	1.0	1.00	5.00	500	17.5	795
80	80	5	2N5336		20	5.00	2.0	1.20	5.00	500	29	1089
80	80	5	2N5337		40	5.00	2.0	1.20	5.00	500	29	1089
80	100	5	2N5152	2N5151	30	2.50	5.0	0.70	2.50	250	15	1075
80	100	5	2N5154	2N5153	70	2.50	5.0	0.70	2.50	250	15	1075
100	100	1	2N5681	2N5679	40	0.25	2.0	1.00	0.50	50	17.5	1113
100	100	5	2N5338		20	5.00	2.0	1.20	5.00	500	29	1089
100	100	5	2N5339		40	5.00	2.0	1.20	5.00	500	29	1089
120	120	1	2N5682	2N5680	40	0.25	2.0	1.00	0.50	50	17.5	1163
150	150	6	BDX53S	BDX54S	500	2.00	5.0	2.00	2.00	8	11.66	223
180	180	4	BDW91	BDW92	1000	2.00	5.0	2.00	2.00	4	17.5	201

SELECTION GUIDE BY PACKAGE

GENERAL PURPOSE TRANSISTORS (cont'd)

SOT-82

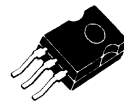
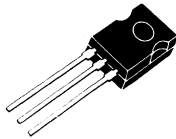

OPTION
SOT-194

V_{CE0} (V)	V_{CBO} (V)	I_C (A)	TYPE	Complement- ary	h_{FE} @ I_C (A)	V_{CE} (V)	V_{CEsat} (V)	I_C @ (A)	I_B (mA)	R_{thj-c} (°C/W)	Page	
60	60	4	SGS110	SGS115	1000	1.00	4.0	2.50	2.00	8	2.5	1017
60	60	6	BD331	BD332	750	3.00	3.0	2.00	3.00	12	2.08	159
60	60	8	SGS130	SGS135	1000	4.00	4.0	2.00	4.00	16	1.78	1029
80	80	4	SGS111	SGS116	1000	1.00	4.0	2.50	2.00	8	2.5	1017
80	80	6	BD333	BD334	750	3.00	3.0	2.00	3.00	12	2.08	159
80	80	8	SGS131	SGS136	1000	4.00	4.0	2.00	4.00	16	1.78	1029
100	100	4	SGS112	SGS117	1000	1.00	4.0	2.50	2.00	8	2.5	1017
100	100	6	BD335	BD336	750	3.00	3.0	2.00	3.00	12	2.08	159
100	100	8	SGS132	SGS137	1000	4.00	4.0	2.00	4.00	16	1.78	1029

TO-220

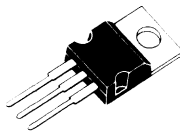

V_{CE0} (V)	V_{CBO} (V)	I_C (A)	TYPE	Complement- ary	h_{FE} @ I_C (A)	V_{CE} (V)	V_{CEsat} (V)	I_C (A)	I_B (mA)	R_{thj-c} (°C/W)	Page	
30	30	10	D44H1	D45H1	20	4.00	1.0	1.00	8.00	800	2.5	803
30	30	10	D44H2	D45H2	40	4.00	1.0	1.00	8.00	400	2.5	803
30	40	4	D44C1		10	1.00	1.0	0.50	1.00	100	4.2	801
30	40	4	D44C2		20	1.00	1.0	0.50	1.00	50	4.2	801
30	40	4	D44C3		20	2.00	1.0	0.50	1.00	50	4.2	801
30	40	7	2N6288	2N6111	30	4.00	3.0	1.00	3.00	300	1.92	1140
40	40	8	2N6386		1000	3.00	3.0	2.00	3.00	6	1.92	1153
40	80	3	TIP31	TIP32	25	1.00	4.0	1.20	3.00	375	3.12	995
40	80	6	TIP41	TIP42	15	3.00	4.0	1.50	6.00	600	1.92	1003
45	45	2	BD239	BD240	15	1.00	4.0	0.70	1.00	200	4.16	153

GENERAL PURPOSE TRANSISTORS (cont'd)

TO-220 (cont'd)

V _{CE0} (V)	V _{CBD} (V)	I _c (A)	TYPE	Complement- ary	h _{FE} @ I _c (A)	V _{CE} (V)	V _{CEsat} @ (V)	I _c (A)	I _B (mA)	R _{thj-c} (°C/W)	Page	
45	45	3	BD241	BD242	25	1.00	4.0	1.20	3.00	600	4.16	155
45	45	4	2N6121	2N6124	25	1.00	2.0	0.60	1.50	150	3.12	1143
45	45	6	BD243	BD244	15	3.00	4.0	1.50	6.00	1000	4.16	157
45	45	8	BD533	BD534	25	2.00	2.0	0.80	2.00	200	2.5	171
45	45	8	BDX53	BDX54	750	3.00	3.0	2.00	3.00	12	2.08	217
45	45	10	BDX33	BDX34	750	4.00	3.0	2.50	4.00	8	1.78	211
45	45	10	D44H4	D45H4	20	4.00	1.0	1.00	8.00	800	2.5	803
45	45	10	D44H5	D45H5	40	4.00	1.0	1.00	8.00	400	2.5	803
45	45	12	BD705	BD706	20	4.00	4.0	1.00	4.00	400	1.67	179
45	45	12	BDW93	BDW94	750	5.00	3.0	2.00	5.00	20	1.56	205
45	45	15	BD905	BD906	15	5.00	4.0	1.00	5.00	500	1.4	185
45	55	4	D44C4		10	1.00	1.0	0.50	1.00	100	4.2	801
45	55	4	D44C5		20	1.00	1.0	0.50	1.00	50	4.2	801
45	55	4	D44C6		20	2.00	1.0	0.50	1.00	50	4.2	801
50	50	15	2N6486	2N6489	20	5.00	4.0	1.30	5.00	500	1.67	1157
60	60	7	2N6290	2N6109	30	4.00	2.5	1.00	2.50	250	3.12	1140
60	60	2	BD239A	BD240A	15	1.00	4.0	0.70	1.00	200	3.12	153
60	60	3	BD241A	BD242A	25	1.00	4.0	1.20	3.00	600	3.12	155
60	60	4	2N6122	2N6125	25	1.50	2.0	0.60	1.50	150	3.12	1143
60	60	4	TIP110	TIP115	1000	1.00	4.0	2.50	2.00	8	2.5	1017
60	60	5	TIP120	TIP125	1000	3.00	3.0	2.00	3.00	12	1.92	1023
60	60	6	BD243A	BD244A	15	3.00	4.0	1.50	6.00	1000	3.12	153
60	60	8	BD535	BD536	25	2.00	2.0	0.80	2.00	200	2.5	171
60	60	8	BDX53A	BDX54A	750	3.00	3.0	2.00	3.00	12	2.08	217
60	60	8	TIP100	TIP105	1000	3.00	4.0	2.00	3.00	6	1.56	1011
60	60	8	TIP130	TIP135	1000	4.00	4.0	2.00	4.00	16	1.78	1029
60	60	10	2N6387		1000	5.00	3.0	2.00	5.00	10	1.92	1153
60	60	10	BDX33A	BDX34A	750	4.00	3.0	2.50	4.00	8	1.78	211
60	60	10	D44H7	D45H7	20	4.00	1.0	1.00	8.00	800	2.5	803
60	60	10	D44H8	D45H8	40	4.00	1.0	1.00	8.00	400	2.5	803
60	60	12	BD707	BD708	15	4.00	4.0	1.00	4.00	400	1.67	179
60	60	12	BDW93A	BDW94A	750	5.00	3.0	2.00	5.00	20	1.56	205
60	60	15	BD907	BD908	15	5.00	4.0	1.00	5.00	500	1.4	185
60	60	15	TIP140T	TIP145T	1000	5.00	4.0	3.00	10.00	40	1.25	1035
60	70	4	D44C7		10	1.00	1.0	0.50	1.00	100	4.2	801
60	70	4	D44C8		20	1.00	1.0	0.50	1.00	50	4.2	801
60	70	4	D44C9		20	2.00	1.0	0.50	1.00	50	4.2	801
60	70	10	MJE3055T	MJE2955T	20	4.00	4.0	1.10	4.00	400	1.66	853
60	100	3	TIP31A	TIP32A	25	1.00	4.0	1.20	3.00	375	3.12	995
60	100	6	TIP41A	TIP42A	15	3.00	4.0	1.50	6.00	600	1.92	1003
70	70	15	2N6487	2N6490	20	5.00	4.0	1.30	5.00	500	1.67	1157
70	80	7	2N6292	2N6107	30	4.00	2.0	1.00	2.00	200	3.12	1140
80	80	2	BD239B	BD240B	15	1.00	4.0	0.70	1.00	200	4.16	153
80	80	3	BD241B	BD242B	25	1.00	4.0	1.20	3.00	600	3.12	155

SELECTION GUIDE BY PACKAGE

GENERAL PURPOSE TRANSISTORS (cont'd)

TO-220 (cont'd)

V _{CEO} (V)	V _{CBO} (V)	I _C (A)	TYPE	Complementary	h _{FE} @	I _C (A)	V _{CE} (V)	V _{CEsat} @	I _C (A)	I _B (mA)	R _{thj-c} (°C/W)	Page
80	80	4	2N6123	2N6126	20	1.50	2.0	0.60	1.50	150	3.12	1143
80	80	4	TIP111	TIP116	1000	1.00	4.0	2.50	2.00	8	2.5	1017
80	80	5	TIP121	TIP126	1000	3.00	3.0	2.00	3.00	12	1.92	1023
80	80	6	BD243B	BD244B	15	3.00	4.0	1.50	6.00	1000	1.92	157
80	80	8	BD537	BD538	15	2.00	2.0	0.80	2.00	200	2.5	171
80	80	8	BDX53B	BDX54B	750	3.00	3.0	2.00	3.00	12	2.08	271
80	80	8	TIP101	TIP106	1000	3.00	4.0	2.00	3.00	6	1.56	1011
80	80	8	TIP131	TIP136	1000	4.00	4.0	2.00	4.00	16	1.78	1029
80	80	10	2N6388		1000	5.00	3.0	2.00	5.00	10	1.92	1153
80	80	10	BDX33B	BDX34B	750	3.00	3.0	2.50	3.00	6	1.78	211
80	80	10	D44H10	D45H10	20	4.00	1.0	1.00	8.00	800	2.5	803
80	80	10	D44H11		40	4.00	1.0	1.00	8.00	400	2.5	803
80	80	12	BD709	BD710	15	4.00	4.0	1.00	4.00	400	1.67	179
80	80	12	BDW93B	BDW94B	750	5.00	3.0	2.00	5.00	20	1.56	205
80	80	15	BD909	BD910	15	5.00	4.0	1.00	5.00	500	1.4	185
80	80	15	TIP141T	TIP146T	1000	5.00	4.0	3.00	10.00	40	1.25	1035
80	90	4	D44C10		10	1.00	1.0	0.50	1.00	100	4.2	801
80	90	4	D44C11		20	1.00	1.0	0.50	1.00	50	4.2	801
80	90	4	D44C12		20	2.00	1.0	0.50	1.00	50	4.2	801
80	120	3	TIP31B	TIP32B	25	1.00	4.0	1.20	3.00	375	3.12	995
80	120	6	TIP41B	TIP42B	15	3.00	4.0	1.50	6.00	600	1.92	1003
90	90	15	2N6488	2N6491	20	5.00	4.0	1.30	5.00	500	1.67	1157
100	100	2	BD239C	BD240C	15	1.00	4.0	0.70	1.00	200	4.16	153
100	100	3	BD241C	BD242C	25	1.00	4.0	1.20	3.00	600	3.12	155
100	100	4	TIP112	TIP117	1000	1.00	4.0	2.50	2.00	8	2.5	1017
100	100	5	TIP122	TIP127	1000	3.00	3.0	2.00	3.00	12	1.92	1023
100	100	6	BD243C	BD244C	15	3.00	4.0	1.50	6.00	1000	3.12	157
100	100	8	2N6045	2N6042	1000	3.00	4.0	2.00	3.00	12	1.56	1135
100	100	8	BDX53C	BDX54C	750	3.00	3.0	2.00	3.00	12	2.08	217
100	100	8	TIP102	TIP107	1000	3.00	4.0	2.00	3.00	6	1.56	1011
100	100	8	TIP132	TIP137	1000	4.00	4.0	2.00	4.00	16	1.78	1029
100	100	10	BDX33C	BDX34C	750	3.00	3.0	2.50	3.00	6	1.78	211
100	100	12	BD711	BD712	15	4.00	4.0	1.00	4.00	400	1.4	179
100	100	12	BDW93C	BDW94C	750	5.00	3.0	2.00	5.00	20	1.56	205
100	100	15	BD911	BD912	15	5.00	4.0	1.00	5.00	500	4.2	185
100	100	15	TIP142T	TIP147T	1000	5.00	4.0	3.00	10.00	40	1.25	1035
100	140	3	TIP31C	TIP32C	25	1.00	4.0	1.20	3.00	375	3.12	995
100	140	6	TIP41C	TIP42C	15	3.00	4.0	1.50	6.00	600	1.92	1003
140	140	6	BDX53E	BDX54E	500	2.00	5.0	2.00	2.00	10	2.08	219
140	160	12	SGSD93E		1000	3.00	3.0	2.00	10.00	20	1.56	881
160	160	6	BDX53F	BDX54F	500	2.00	5.0	2.00	2.00	10	2.08	219
160	180	12	SGSD93F		1000	3.00	3.0	2.00	10.00	20	1.56	881
180	200	12	SGSD93G		1000	3.00	3.0	2.00	10.00	20	1.56	881
400	450	6	BU911		20	4.00	1.8	1.80	2.50	50	2.08	325
400	450	10	BU921T		50	7.00	1.8	1.80	5.00	50	1.2	329

GENERAL PURPOSE TRANSISTORS (cont'd)

TO-218

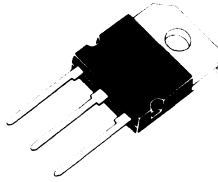

V_{CE0} (V)	V_{CB0} (V)	I_C (A)	TYPE	Complementary	h_{FE} @ I_C	I_C (A)	V_{CE} (V)	V_{CEsat} @ I_C	I_C (A)	I_B (mA)	R_{thj-c} (°C/W)	Page
60	60	10	TIP140	TIP145	1000	5.00	4.0	3.00	10.00	40	1	1031
60	60	12	BDV65	BDV64	1000	5.00	4.0	2.00	5.00	20	1	189
60	60	15	BDW83A	BDW84A	750	6.00	3.0	2.50	6.00	12	0.96	199
60	100	10	TIP33A	TIP34A	20	3.00	4.0	1.00	3.00	300	1.39	999
60	100	15	TIP3055	TIP2955	20	4.00	4.0	1.10	4.00	400	1.39	1037
60	100	25	TIP35A	TIP36A	10	15.00	4.0	1.80	15.00	1500	1	1001
80	80	10	TIP141	TIP146	1000	5.00	4.0	3.00	10.00	40	1	1031
80	80	12	BDV65A	BDV64A	1000	5.00	4.0	2.00	5.00	20	1	189
80	80	15	BDW83B	BDW84B	750	6.00	3.0	2.50	6.00	12	0.96	199
80	80	25	SGSD100	SGSD200	300	20.00	3.0	1.75	10.00	40	0.96	885
80	120	10	TIP33B	TIP34B	20	3.00	4.0	1.00	3.00	300	1.39	999
80	120	25	TIP35B	TIP36B	10	15.00	4.0	1.80	15.00	1500	1	1001
100	100	10	TIP142	TIP147	1000	5.00	4.0	3.00	10.00	40	1	1031
100	100	12	BDV65B	BDV64B	1000	5.00	4.0	2.00	5.00	20	1	189
100	100	15	BDW83C	BDW84C	750	6.00	3.0	2.50	6.00	12	0.96	199
100	140	10	TIP33C	TIP34C	20	3.00	4.0	1.00	3.00	300	1.39	999
100	140	25	TIP35C	TIP36C	10	15.00	4.0	1.80	15.00	1500	1	1001
350	350	15	BU9312P		80	8.00	1.8	1.60	7.00	70	1	343
400	450	10	BU921P		50	7.00	1.8	1.80	5.00	50	1.2	329
400	450	15	BU931RP		300	5.00	10.0	1.60	7.00	70	1	337

GENERAL PURPOSE TRANSISTORS (cont'd)

ISOWATT220

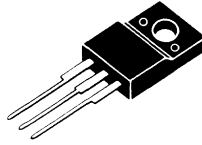

V_{CE0} (V)	V_{CB0} (V)	I_C (A)	TYPE	Complementary	h_{FE} @ I_C (A)	V_{CE} (V)	V_{CEsat} @ I_C (V)	I_C (A)	I_B (mA)	R_{thj-c} (°C/W)	Page
400	450	10	BU921TFI		50	1.8	1.80	5.00	50	3.12	*

* Datasheet available on request

ISOWATT218

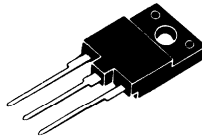

V_{CE0} (V)	V_{CB0} (V)	I_C (A)	TYPE	Complementary	h_{FE} @ I_C (A)	V_{CE} (V)	V_{CEsat} @ I_C (V)	I_C (A)	I_B (mA)	R_{thj-c} (°C/W)	Page
350	350	15	BU931ZPFI		80	1.8	1.60	7.00	70	2.08	343
400	450	10	BU921PFI		50	1.8	1.80	5.00	50	2.27	329
400	450	15	BU931RPF1		300	10.0	1.60	7.00	70	2.08	337

GENERAL PURPOSE TRANSISTORS (cont'd)

TO-3

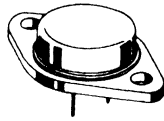

V_{CE0} (V)	V_{CB0} (V)	I_C (A)	TYPE	Complement- ary	$h_{FE} @$	I_C (A)	V_{CE} (V)	$V_{CEsat} @$	I_C (A)	I_B (mA)	R_{th-j-c} (°C/W)	Page
40	40	30	2N5301	2N4398	15	15.00	2.0	1.00	15.00	1500	0.875	1083
40	50	15	2N3771		15	15.00	4.0	2.00	15.00	1500	1.17	1053
45	45	10	BDX85	BDX86	1000	3.00	3.0	2.00	4.00	16	1.75	227
45	45	15	BDW51	BDW52	20	5.00	4.0	1.00	5.00	500	1.4	193
60	60	8	2N6055	2N6053	750	4.00	3.0	2.00	4.00	16	1.75	1139
60	60	8	MJ1000	MJ900	1000	3.00	3.0	2.00	3.00	12	1.94	815
60	60	10	2N5877	2N5875	20	4.00	4.0	1.00	5.00	500	1.17	1115
60	60	10	BDX85A	BDX86A	1000	3.00	3.0	2.00	4.00	16	1.75	227
60	60	10	MJ3000	MJ2500	1000	5.00	3.0	2.00	5.00	20	1.17	817
60	60	12	2N6057	2N6050	750	6.00	3.0	2.00	6.00	24	1.17	1137
60	60	12	BDX87A	BDX88A	1000	5.00	3.0	2.00	6.00	24	1.75	233
60	60	15	BDW51A	BDW52A	20	5.00	4.0	1.00	5.00	500	1.4	193
60	60	16	MJ4033	MJ4030	1000	10.00	3.0	4.00	16.00	80	1.17	821
60	60	20	2N6282	2N6285	750	10.00	3.0	3.00	20.00	200	1.09	1149
60	60	25	2N5885	2N5883	20	10.00	4.0	1.00	15.00	1500	0.875	1121
60	60	30	2N5302	2N4399	15	15.00	2.0	1.00	15.00	1500	0.875	1083
60	60	30	MJ11012	MJ11011	1000	20.00	5.0	4.00	30.00	300	0.875	825
60	80	10	2N3715	2N3791	30	3.00	2.0	0.80	5.00	500	1.17	1047
60	100	15	2N3055	MJ2955	20	4.00	4.0	1.10	4.00	400	1.5	1037
60	100	15	2N3772		15	10.00	4.0	1.40	10.00	1000	1.17	1053
80	80	8	MJ1001	MJ901	1000	3.00	3.0	2.00	3.00	12	1.94	815
80	80	10	2N5878	2N5876	20	4.00	4.0	1.00	5.00	500	1.17	1115
80	80	10	BDX85B	BDX86B	1000	3.00	3.0	2.00	4.00	16	1.75	227
80	80	10	MJ3001	MJ2501	1000	5.00	3.0	2.00	5.00	20	1.17	817
80	80	12	2N6058	2N6051	750	6.00	3.0	2.00	6.00	24	1.17	1137
80	80	12	BDX87B	BDX88B	1000	5.00	3.0	2.00	6.00	24	1.45	233
80	80	15	BDW51B	BDW52B	20	5.00	4.0	1.00	5.00	500	1.4	193
80	80	16	MJ4034	MJ4031	1000	10.00	3.0	4.00	16.00	80	1.17	821
80	80	20	2N5303	2N5745	15	10.00	2.0	1.50	15.00	1500	0.875	1083
80	80	20	2N6283	2N6286	750	10.00	3.0	3.00	20.00	200	1.09	1149
80	80	25	2N5886	2N5884	20	10.00	4.0	1.00	15.00	1500	0.875	1121
80	100	10	2N3716	2N3792	30	3.00	2.0	0.80	5.00	500	1.17	1047
90	90	30	MJ11014	MJ11013	1000	20.00	5.0	4.00	30.00	300	0.875	825
90	100	30	MJ802	MJ4502	25	7.50	2.0	0.80	7.50	750	0.875	809
100	100	10	BDX85C	BDX86C	1000	3.00	3.0	2.00	4.00	16	1.17	227

GENERAL PURPOSE TRANSISTORS (cont'd)

TO-3 (cont'd)

V_{CE0} (V)	V_{CBO} (V)	I_C (A)	TYPE	Complementary	h_{FE} @ I_C		V_{CE} (V)	V_{CEsat} @ I_C		I_B (mA)	R_{thj-c} (°C/W)	Page
						(A)		(V)	(A)			
100	100	12	2N6059	2N6052	750	6.00	3.0	2.00	6.00	24	1.17	1137
100	100	12	BDX87C	BDX88C	1000	5.00	3.0	2.00	6.00	24	1.45	233
100	100	15	BDW51C	BDW52C	20	5.00	4.0	1.00	5.00	500	1.4	193
100	100	16	2N5629	2N6029	25	8.00	2.0	1.00	10.00	1000	0.875	1097
100	100	16	MJ4035	MJ4032	1000	10.00	3.0	4.00	16.00	80	1.17	821
100	100	20	2N6284	2N6287	750	10.00	3.0	3.00	20.00	200	1.09	1149
120	120	30	MJ11016	MJ11015	1000	20.00	5.0	4.00	30.00	300	0.875	825
350	350	15	BU931Z		80	8.00	1.8	1.60	7.00	70	1	343
450	400	10	BU921		50	7.00	1.8	1.80	5.00	50	1.25	329
450	400	15	BU931R		300	5.00	10.0	1.60	7.00	70	1	337

SWITCHING TRANSISTORS

SOT-32

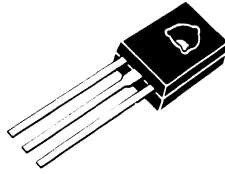

V_{CBO} (V)	V_{CEO} (V)	I_C (A)	TYPE	Complementary	V_{CEsat} [ⓐ] (V)	I_C (A)	I_B (mA)	t_s (μ s)	t_f (μ s)	R_{thj-c} ($^{\circ}$ C/W)	Page
200	200	3	BU325	MJE350	1.50	0.50	50	0.75●	0.20●	5	277
250	200	3	BUY49P		0.20	0.50	50	0.75	0.20	8.33	789
275	250	0.5	2N5655		1.00	0.10	10			6.25	1103
275	250	0.5	BD157							6.25	141
300	300	0.5	MJE340							6	837
325	300	0.5	2N5656		1.00	0.10	10			6.25	1103
325	300	0.5	BD158							6.25	141
350	250	0.3	MJE3440		0.50	0.05	4			8.33	855
375	350	0.5	2N5657		1.00	0.10	10			6.25	1103
375	350	0.5	BD159							6.25	141
450	350	0.3	MJE3439		0.50	0.05	4			8.33	855
600	400	3	BU801		2.20	1.00	15	1	0.5	3.12	307

● Typical value

SOT-82

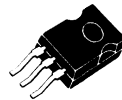
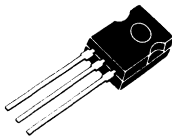
OPTION
SOT-194

V_{CBO} (V)	V_{CEO} (V)	I_C (A)	TYPE	Complementary	V_{CEsat} [ⓐ] (V)	I_C (A)	I_B (mA)	t_s (μ s)	t_f (μ s)	R_{thj-c} ($^{\circ}$ C/W)	Page
300	300	0.5	SGS340	SGS350						6	837
350	250	0.3	SGS3440		0.50	0.05	4			8.33	855
450	350	0.3	SGS3439		0.50	0.05	4			8.33	855
600	300	1.5	SGS13002		1.00	1.00	250	2.5	0.5	2.5	877
700	400	1.5	SGS13003		1.0	1.00	250	2.5	0.5	2.5	877

SWITCHING TRANSISTORS (cont'd)

TO-39

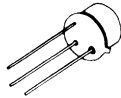

V _{CB0} (V)	V _{CEO} (V)	I _C (A)	TYPE	Complementary	V _{CEsat} ^① (V)	I _C (A)	I _B (mA)	t _s (μs)	t _f (μs)	R _{thj-c} (°C/W)	Page
120	60	5	2N4895		1.00	5.00	500	0.35	0.3	25	1059
120	60	5	2N4896		1.00	5.00	500	0.35	0.3	25	1059
120	120	1.5	BSW67		1.00	1.00	150	0.7●	0.22●	35	651
130	60	6	BU125		1.00	5.00	500			15	255
150	80	5	2N4897		1.00	5.00	500	0.35	0.3	25	1059
150	120	7	BUY47		1.00	5.00	500	0.7	0.04	15	785
150	150	1.5	BSW68		1.00	1.00	150	0.7●	0.22●	35	651
200	170	7	BUY48		1.00	5.00	500	0.7	0.04●	15	785
200	200	1		2N5415	2.50	0.05	5	0.3	0.2	17.5	1093
250	150	3	BU125S		1.50	0.50	50			17.5	259
250	200	3	BUY49S		0.20	0.50	50	0.75	0.30	17.5	791
300	250	1	2N3440		0.50	0.05	4			17.5	1043
350	300	1		2N5416	2.50	0.05	5	0.3	0.2	17.5	1093
450	350	1	2N3439		0.50	0.05	4			17.5	1043

● Typical value

TO-220

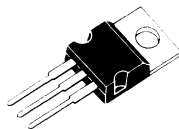

V _{CB0} (V)	V _{CEO} (V)	I _C (A)	TYPE	Complementary	V _{CEsat} ^① (V)	I _C (A)	I _B (mA)	t _s (μs)	t _f (μs)	R _{thj-c} (°C/W)	Page
140	90	7	2N6702		0.80	5.00	500	1	0.5	2.5	1179
180	90	14	BUV26		0.60	6.00	600	1	0.25	1.76	441
200	125	4	D44Q1		1.00	2.00	200	2	1.7	4	805
200	125	16	BUT60		0.90	12.00	600	1.5▲	0.2▲	1	*
240	120	12	BUV27		0.70	4.00	400	1.2	0.25	1.76	447

▲ Inductive load

* Datasheet on request

SWITCHING TRANSISTORS (cont'd)

TO-220 (cont'd)

V _{CEO} (V)	V _{CE0} (V)	I _C (A)	TYPE	Complementary	V _{CEsat} ^① (V)	I _C (A)	I _B (mA)	t _s (μs)	t _f (μs)	R _{thj-c} (°C/W)	Page
250	175	4	D44Q3	MJE350T	1.00	2.00	200	2	1.7	4	805
300	225	4	D44Q3		1.00	2.00	200	2	1.7	4	805
300	300	0.5	MJE340T							6	837
330	150	7	BU407		1.00	5.00	500	0.9●	0.3●	2.08	297
330	150	7	BU407D		1.00	5.00	650	0.9●	0.3●	2.08	291
330	150	8	BU189			1.50	5.00	50	0.5	0.44●	2.08
330	150	8	BU807		1.50	5.00	50	0.55●	0.2●	2.08	311
350	250	1	TIP47		1.00	1.00	200	1.2●	0.45●	3.12	1005
350	250	5	2N6497		1.00	2.50	500	1.8	0.8	1.56	1159
400	200	7	BU406		1.00	5.00	500	0.9●	0.3●	2.08	285
400	200	7	BU406D		1.00	5.00	650	0.9●	0.3●	2.08	291
400	200	8	BU184		1.50	5.00	50	0.5	0.44●	2.08	263
400	200	8	BU806		1.50	5.00	50	0.55●	0.2●	2.08	311
400	200	10	BUV28		1.50	6.00	600	1.5	0.25	1.76	453
400	300	1	TIP48		1.00	1.00	200	1.3●	0.45●	3.12	1005
400	300	5	2N6498	BUW22P	1.25	2.50	500	1.8	0.8	1.56	1159
400	300	16	BUT62		0.90	10.00	1000	2.2▲	0.4▲	1	*
400	350	6			1.50	2.50	1000	1.5	0.7	2	563
450	300	8	2N6928		1.00	8.00	1600	2.5	0.4	1.25	*
450	350	1	TIP49		1.00	1.00	200	1.3●	0.45●	3.12	1005
450	350	5	2N6499	BUW22AP	1.50	2.50	500	1.8	0.8	1.56	1159
450	400	6			1.50	2.50	1000	1.5	0.7	2	563
500	400	1	TIP50		1.00	1.00	200	1.3●	0.45●	3.12	1005
550	350	8	2N6929		1.00	8.00	1600	2.5	0.4	1.25	*
600	300	1.5	SGS13002T		1.00	1.00	250	2.5	0.5	2.5	877
600	300	4	MJE13004		1.00	4.00	1000	4	0.9	1.67	859
600	300	8	MJE13006		1.50	5.00	1000	3	0.7	1.56	863
600	300	12	MJE13008		1.50	8.00	1600	3	0.7	1.25	871
600	400	7	BU810		2.50	4.00	200	1.5	0.5	1.66	321
650	400	8	2N6930		1.00	8.00	1600	2.5	0.4	1.25	*
650	400	8	SGSD00020		4.00	3.00	3				895
700	400	1.5	SGS13003T		1.0	1.00	250	2.5	0.5	2.5	877
700	400	4	MJE13005		1.0	4.00	1000	4	0.9	1.67	859
700	400	8	MJE13007		1.5	5.00	1000	3	0.7	1.56	863
700	400	12	MJE13009		1.5	8.00	1600	3	0.7	1.25	871
800	400	2	BUX84		3.0	1.00	200	3.5	0.4●	3.12	765
850	400	5	BUT11		1.5	3.00	600	4	0.8	1.5	379
850	400	5	BUV46		1.5	2.50	500	3	0.8	1.76	195
850	400	5	SGSF321		1.5	3.50	700	2.5	0.3	1.78	907
850	400	8	MJE13007A		1.5	5.00	1000	3	0.7	1.56	863
850	400	10	SGSF341		1.5	6.00	1200	2.5	0.3	1.47	931
850	450	7.5	BUF405		0.5●	5.00	1000				349
850	450	9	BUV56		1.2	5.00	1000	3▲	0.4▲	1.76	525
850	450	15	BUV66		1.2	8.00	1600	3▲	0.4▲	1.25	557

▲ Inductive load

● Typical value

T_J = 125°C

* Datasheet on request

SWITCHING TRANSISTORS (cont'd)

TO-220 (cont'd)

V_{CBO} (V)	V_{CEO} (V)	I_C (A)	TYPE	Complementary	V_{CEsat} @ (V)	I_C (A)	I_B (mA)	t_s (μ s)	t_f (μ s)	R_{thj-c} ($^{\circ}$ C/W)	Page
1000	400	7	SGSD00055		2.5	3.00	200	0.8	0.15	1.66	905
1000	450	2	BUX85		1.0	1.00	200	3.5	0.4●	2.5	*
1000	450	5	BUT11A		1.5	2.50	500	4	0.8	1.5	379
1000	450	5	BUV46A		1.5	2.00	400	3	0.8	1.76	495
1000	450	5	SGSF323		1.5	2.50	500	2.5	0.3	1.78	913
1000	450	7.5	BUF405A		0.5●	5.00	1000				349
1000	450	8	SGSF343		1.5	4.50	900	2.5	0.35	1.47	937
1200	600	4	SGSF324		1.5	1.75	350	4.5	0.35	1.78	919
1200	600	7	SGSF344		1.5	3.50	700	3.5	0.3	1.47	943

TO-218

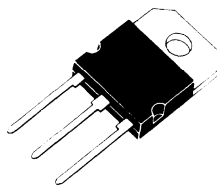

V_{CBO} (V)	V_{CEO} (V)	I_C (A)	TYPE	Complementary	V_{CEsat} @ (V)	I_C (A)	I_B (mA)	t_s (μ s)	t_f (μ s)	R_{thj-c} ($^{\circ}$ C/W)	Page
120	60	30	BUW48		0.60	20.00	2000	1.1	0.25	1	601
160	80	30	BUW49		0.50	15.00	1500	1.1	0.25	1	601
160	90	25	BUW89		0.90	15.00	1500	1	0.25	1.2	633
160	125	25	BUX10P		0.60	10.00	1000	1.2	0.3	1.17	669
160	140	25	BU999		0.80	10.00	1000	1.5	0.25	1.17	347
200	125	40	BUT70		0.90	35.00	1750	1.8▲	0.2▲	0.63	*
250	125	20	BUW90		0.90	11.00	1100	1	0.3	1.2	641
250	125	25	BUW50		0.90	20.00	2000	1.2	0.3	1	609
300	125	15	BUW91		0.90	6.00	600	1.2	0.3	1.2	649
300	200	20	BUW51		0.90	10.00	1000	1.4	0.3	1	617
350	250	5	TIP51		1.50	3.00	600	2.5●	0.2●	1.25	1009
350	250	12	BUW92		0.80	2.00	130	1.6	0.3	1.2	657
350	250	20	BUW52		0.80	4.00	260	1.6	0.3	1	625
400	300	5	TIP52		1.50	3.00	600	2.5●	0.2●	1.25	1009
400	300	40	BUT72		0.90	30.00	3000	3▲	0.4▲	0.63	*

▲ Inductive load

● Typical value

* Datasheet on request

SWITCHING TRANSISTORS (cont'd)

TO-218 (cont'd)

V_{CE0} (V)	V_{CE0} (V)	I_C (A)	TYPE	Complementary	V_{CEsat} ^① (V)	I_C (A)	I_B (mA)	t_s ^② (μ s)	t_f (μ s)	R_{thj-c} ($^{\circ}$ C/W)	Page
400	350	10		BUW32P	1.50	5.00	1500	1.5	0.6	1.2	569
400	350	15		BUW42P	1.50	10.00	3000	1.5	0.6	1.2	593
400	350	20	MJ10004P		1.90	10.00	400	1.5	0.5	1	823
450	300	10	2N6931		1.00	10.00	2000	2.5	0.5	0.83	1181
450	300	15	2N6933		1.00	15.00	3000	2.5	0.5	0.71	1185
450	350	5	TIP53		1.50	3.00	600	2.5●	0.2●	1.25	1009
450	400	10		BUW32AP	1.50	5.00	1500	1.5	0.6	1.2	569
450	400	15		BUW42AP	1.50	10.00	3000	1.5	0.5	1.2	593
450	400	20	MJ10005P		1.90	10.00	400	1.5	0.5	1	823
500	400	5	TIP54		1.50	3.00	600	2.5●	0.2●	1.25	1009
550	350	15	2N6934		1.00	15.00	3000	2.5	0.5	0.71	1185
600	400	28	BUT13P		2.00	10.00	500	1.5	0.6	1	385
600	400	28	SGSD311		2.50	18.00	1800	1.5	0.5	1	889
650	400	10	2N6932		1.00	10.00	2000	2.5	0.5	0.83	1181
650	400	15	2N6935		1.00	15.00	3000	2.5	0.5	0.71	1185
650	400	28	SGSD00030		2.50	12.00	100	1.5	0.5	1	897
800	375	6	BU426		1.5	2.50	500	3.5	0.5	1.16	303
850	400	5	SGSF421		1.5	3.50	700	2.5	0.3	1.56	907
850	400	8	BUW12		1.5	6.00	1200	4	0.8	1.2	561
850	400	9	BUV47		1.5	6.00	1200	2.5	0.8	1.25	735
850	400	10	SGSF441		1.5	6.00	1200	2.5	0.3	1.31	931
850	400	15	BUV48		1.5	10.00	2000	3	0.8	1	745
850	400	15	SGSF461		1.5	10.00	2000	2.3	0.5	1	955
850	450	8	MJH16006		3.0	5.00	660				*
850	450	8	MJH16008		3.0	5.00	500				*
850	450	15	BUF410		0.5*	10.00	2000				353
850	450	15	MJH16010		3.0	10.00	1300				*
850	450	15	MJH16012		3.0	10.00	1000				*
850	450	30	BUF420		0.5*	20.00	4000				357
850	450	30	BUX98P		0.9	20.00	4000	3	0.8	0.63	773
900	400	6	BU426A		1.5	2.50	500	3.5	0.5	1.1	303
1000	450	5	SGSF423		1.5	2.50	500	2.5	0.3	1.56	913
1000	450	8	BUW12A		1.5	6.00	1200	4	0.8	1.2	561
1000	450	8	SGSF443		1.5	4.50	900	2.5	0.35	1.31	937
1000	450	9	BUV47A		1.5	5.00	1000	3	0.8	1.25	735
1000	450	12	SGSF463		1.5	7.00	1400	2.3	0.5	1	961
1000	450	15	BUF410A		0.5*	10.00	2000				353
1000	450	15	BUV48A		1.5	8.00	1600	3	0.8	1	745
1000	450	30	BUF420A		0.5*	20.00	4000				357
1000	550	6	2ST3153		2.0	3.00	600				*
1200	600	4	SGSF424		1.5	1.75	350	4.5	0.35	1.56	919
1200	600	6	2ST3642		5.0	4.00	800				*
1200	600	7	SGSF444		1.5	3.50	700	3.5	0.3	1.31	943
1200	600	10	SGSF464		1.5	6.00	1200	3.5	0.4	1	967

* Datasheet on request

● Typical value

SWITCHING TRANSISTORS (cont'd)

TO-218 (cont'd)

V _{CE0} (V)	V _{CEO} (V)	I _C (A)	TYPE	Complementary	V _{CEsat} [ⓐ] (V)	I _C (A)	I _B (mA)	t _s (μs)	t _f (μs)	R _{thj-c} (°C/W)	Page
1200	600	12	2ST3552		2.0	6.00	1200				*
1200	600	15	BUV48B		1.5	6.00	1500	3	0.7	1	755
1200	700	15	BUV48C		1.5	6.00	1500	3	0.7	1	755
1300	600	4	SGSF425		1.5	1.25	250	4.5	0.35	1.56	925
1300	600	7	SGSF445		1.5	3.00	600	3.5	0.3	1.31	949
1300	600	10	SGSF465		1.5	5.00	1000	3.5	0.4	1	973
1500	700	2.5	2ST1396		8.0	2.00	600				*
1500	700	3	2SD1453		5.0	2.50	800				*
1500	700	4	2SD1441		1.0	3.00	1000				*
1500	700	5	2SD1455		5.0	4.50	1200				*
1500	700	5	2SD1730		8.0	4.00	1000				*
1500	700	5	2ST3485		5.0	4.00	1000				*
1500	700	5	BU706		5.0	3.00	1330				305
1500/700	6	2ST3460			2.0	3.00	600				*
1500	700	7.5	2ST2000		1.0	4.00	2000				*
1500	700	8	2ST3461		2.0	4.00	800				*
1500	700	8	BU508		5.0	4.50	2000	7●	0.55●	1	267
1500	700	8	BU508A		1.0	4.50	2000	7●	0.55●	1	267
1500	700	8	BU508D		1.0	4.50	2000	7●	0.55●	1	271

ISOWATT220

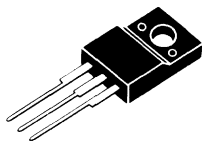

V _{CE0} (V)	V _{CEO} (V)	I _C (A)	TYPE	Complementary	V _{CEsat} [ⓐ] (V)	I _C (A)	I _B (mA)	t _s [ⓐ] (μs)	t _f (μs)	R _{thj-c} (°C/W)	Page
330	150	8	BU807FI		1.5	5.00	50	0.55●	0.2●	2.08	311
400	200	8	BU806FI		1.5	5.00	50	0.55●	0.22●	4.16	311
850	400	5	BUT11FI		1.5	3.00	600	4	0.8	3.57	379
850	400	5	BUV46FI		1.5	2.50	500	3	0.8	4.16	495
850	400	5	SGSIF321		1.5	3.50	700	2.5	0.3	3.57	907
850	400	10	BUT12FI		1.5	6.00	1200				*
850	400	10	SGSIF341		1.5	6.00	1200	2.5	0.3	3.12	931
1000	450	5	BUT11AFI		1.5	2.50	500	4	0.8	3.57	379
1000	450	5	BUV46AFI		1.5	2.00	400				495
1000	450	5	SGSIF323		1.5	2.50	500	2.5	0.3	3.57	913

* Datasheet on request

● Typical value

SWITCHING TRANSISTORS (cont'd)

ISOWATT220 (cont'd)

V _{CEO} (V)	V _{CE0} (V)	I _C (A)	TYPE	Complementary	V _{CEsat} [®] (V)	I _C (A)	I _B (mA)	t _s (μs)	t _f (μs)	R _{thj-c} (°C/W)	Page
1000	450	8	SGSIF343		1.5	4.50	900	2.5	0.35	3.12	937
1000	450	10	BUT12AFI		1.5	5.00	1000				*
1200	600	4	SGSIF324		1.5	1.75	350	4.5	0.35	3.57	919
1200	600	7	SGSIF344		1.5	3.50	700	3.5	0.3	3.12	943

ISOWATT218

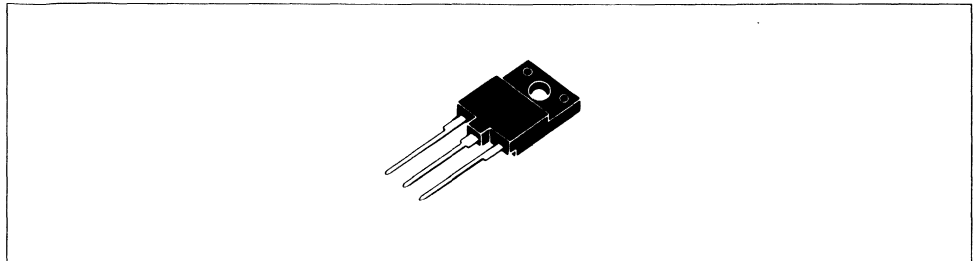

V _{CEO} (V)	V _{CE0} (V)	I _C (A)	TYPE	Complementary	V _{CEsat} [®] (V)	I _C (A)	I _B (mA)	t _s (μs)	t _f (μs)	R _{thj-c} (°C/W)	Page
400	350	10		BUW32PFI	1.50	5.00	1500	1.5	0.6	2.27	569
400	350	15		BUW42PFI	1.50	10.00	3000	1.5	0.6	1.92	593
400	350	20	MJ10004PFI		1.90	10.00	400	1.5	0.5	2.08	823
450	400	10		BUW32APFI	1.50	5.00	1500	1.5	0.6	2.27	569
450	400	15		BUW42APFI	1.50	10.00	3000	1.5	0.6	1.92	593
450	400	20	MJ10005PFI		1.90	10.00	400	1.5	0.5	2.08	823
600	400	28	BUT13PFI		2.00	10.00	500	1.5	0.6	2.08	385
600	400	28	SGSD311FI		2.50	18.00	1800	1.5	0.5	2.08	889
650	400	28	SGSD00030FI		2.50	12.00	100	1.5	0.5	2.08	897
800	375	6	BU426FI		1.5	2.50	500	3.5	0.5	2.5	303
850	400	5	SGSIF421		1.5	3.50	700	2.5	0.3	2.77	907
850	400	9	BUV47FI		1.5	6.00	1200	2.5	0.8	2.27	303
850	400	10	SGSIF441		1.5	6.00	1200	2.5	0.3	2.27	931
850	400	15	BUV48FI		1.5	10.00	2000	3	0.8	1.92	745
850	400	15	SGSIF461		1.5	10.00	2000	2.3	0.5	1.92	955
900	400	6	BU426AFI		1.5	2.50	500	3.5	0.5	2.5	303
1000	450	5	SGSIF423		1.5	2.50	500	2.5	0.3	2.77	913
1000	450	8	SGSIF443		1.5	4.50	900	2.5	0.35	2.27	937
1000	450	9	BUV47AFI		1.5	5.00	1000	3	0.8	2.27	735
1000	450	12	SGSIF463		1.5	7.00	1400	2.3	0.5	1.92	961
1000	450	15	BUV48AFI		1.5	8.00	1600	3	0.8	1.92	745
1000	500	5	2ST3679FI		0.5	2.00	400				*
1200	600	4	SGSIF424		1.5	1.75	350	4.5	0.35	2.77	919
1200	600	7	SGSIF444		1.5	3.50	700	3.5	0.3	2.27	943
1200	600	10	SGSIF464		1.5	6.00	1200	3.5	0.4	1.92	967
1200	600	15	BUV48BFI		1.5	6.00	1500	3	0.7	1.92	755

* Datasheet on request

SELECTION GUIDE BY PACKAGE

SWITCHING TRANSISTORS (cont'd)

ISOWATT218 (cont'd)

V_{CB0} (V)	V_{CEO} (V)	I_C (A)	TYPE	Complementary	V_{CEsat} ^① (V)	I_C (A)	I_B (mA)	t_s (μ s)	t_f (μ s)	R_{thj-c} ($^{\circ}$ C/W)	Page
1200	700	15	BUV48CFI		1.5	6.00	1500	3	0.7	1.92	755
1300	600	4	SGSIF425		1.5	1.25	250	4.5	0.35	2.77	925
1300	600	7	SGSIF445		1.5	3.00	600	3.5	0.3	2.27	949
1300	600	10	SGSIF465		1.5	5.00	1000	3.5	0.4	1.92	973
1400	700	10	BU808FI		1.6	5.00	500			2.5	317
1400	700	10	BU808DFI		1.6	5.00	500			2.5	317
1500	600	2.5	2SD1425FI		8.0	2.00	600				*
1500	600	2.5	2SD1429FI		8.0	2.00	600				*
1500	600	3.5	2SD1426FI		8.0	3.00	800				*
1500	600	3.5	2SD1430FI		8.0	3.00	800				*
1500	600	5	2SD1427FI		5.0	4.00	800				*
1500	600	5	2SD1431FI		5.0	4.00	800				*
1500	600	6	2SD1428FI		5.0	5.00	1000				*
1500	600	6	2SD1432FI		5.0	5.00	1000				*
1500	700	2.5	S2056FI		5.0	2.00	1000				*
1500	700	3	2SD1910FI		5.0	2.50	800				*
1500	700	3.5	2SD1650FI		8.0	2.50	800				*
1500	700	4	2ST1877FI		5.0	2.50	800				*
1500	700	5	2ST1577FI		2.0	4.50	2000				*
1500	700	5	2ST1651FI		5.0	4.00	800				*
1500	700	5	2ST3485FI		5.0	4.00	1000				*
1500	700	7	2ST2000FI		1.0	4.00	2000				*
1500	700	7.5	S2000FI		5.0	4.50	2000				*
1500	700	8	BU508AFI		1.0	4.50	2000	7●	0.55●	2.08	267
1500	700	8	BU508DFI		1.0	4.50	2000	7●	0.55●	2.08	271
1500	700	8	BU508FI		5.0	4.50	2000	7●	0.55●	2.08	267

TO-31

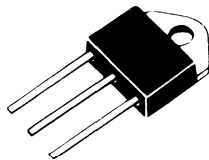

V_{CB0} (V)	V_{CEO} (V)	I_C (A)	TYPE	Complementary	V_{CEsat} ^① (V)	I_C (A)	I_B (mA)	t_s (μ s)	t_f (μ s)	R_{thj-c} ($^{\circ}$ C/W)	Page
850	450	15	BUF410I		0.5●	10.00	2000			1.47	353
850	450	30	BUF420I		0.5●	20.00	4000			1.09	357
1000	450	15	BUF410AI		0.5●	10.00	2000			1.47	353
1000	450	30	BUF420AI		0.5●	20.00	4000			1.09	357

* Datasheet on request

● Typical value

SWITCHING TRANSISTORS (cont'd)

TO-3

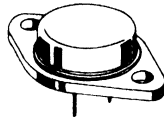

V_{CBO} (V)	V_{CEO} (V)	I_C (A)	TYPE	Complementary	V_{CEsat} ^① (V)	I_C (A)	I_B (mA)	t_s (μ s)	t_f (μ s)	R_{thj-c} ($^{\circ}$ C/W)	Page
60	80	10	BDY92		0.50	5.00	500	1.3	0.2	2.5	241
60	120	50	BUV18		0.60	40.00	4000	1.1	0.3	0.7	425
80	100	10	BDY91		0.50	5.00	500	1.3	0.2	2.5	241
80	160	50	BUV19		0.60	30.00	3000	1.1	0.25	0.7	425
100	120	10	BDY90		0.50	5.00	500	1.3	0.2	2.5	241
120	60	30	BUW38		0.60	20.00	2000	1.1	0.39	1.17	583
120	75	20	2N5039		1.00	10.00	1000	1.5	0.5	1.25	1067
120	80	25	BDY57		1.40	10.00	1000	1.5	0.5	1	239
120	90	30	2N5671		0.75	15.00	1200	1.5	0.5	1.25	1107
120	90	50	2N6032		1.30	50.00	5000	1.5	0.5	1.25	1127
150	90	20	2N5038		1.00	12.00	1200	1.5	0.5	1.25	1067
150	120	30	2N5672		0.75	15.00	1200	1.5	0.5	1.25	1107
150	120	40	2N6033		1.00	40.00	4000	1.5	0.5	1.25	1127
160	80	30	BUW39		0.50	15.00	1500	1.1	0.39	1.17	583
160	90	25	BUV39		1.20	20.00	2500	1	0.25	1.46	459
160	125	20	BUX40		1.20	10.00	1000	1	0.4	1.46	715
160	125	25	BDY58		1.40	10.00	1000	1.5	0.5	1	239
160	125	25	BUX10		0.60	10.00	1000	1.2	0.3	1.17	665
160	125	50	BUV20		0.60	25.00	2500	1.2	0.25	0.7	433
160	125	50	BUX20		0.60	25.00	2500	1.2	0.3	0.5	687
200	125	50	BUR20		1.00	25.00	2000			0.7	361
200	125	50	BUT100		0.90	50.00	2500	2#	0.2#	0.58	417
200	125	50	BUT90		0.90	35.00	1750	1.5	0.4	0.7	391
200	125	70	BUR50		1.00	35.00	2000	2	0.5	0.5	367
200	125	70	BUR50S		1.00	35.00	2000	2	0.5	0.5	367
220	160	18	BUX41N		1.20	8.00	800	1.5	0.8	1.46	723
220	160	20	BUX11N		0.60	8.00	800	1.5	0.5	1.17	675
250	125	20	BUV40		0.90	11.00	1100	1	0.3	1.46	467
250	125	25	BUV50		0.90	20.00	2000	1.2	0.3	1.17	497
250	125	50	BUV60		0.90	50.00	5000	1.1	0.2	0.7	529
250	200	15	BUX41		1.20	4.00	400	1.7	0.8	1.46	719
250	200	20	BUX11		0.60	6.00	600	1.8	0.4	1.17	671
250	200	40	BUV21		0.60	12.00	1200	1.8	0.4	0.7	433
250	200	40	BUX21		0.60	12.00	1200	1.8	0.4	0.5	691
300	200	15	BUV41		0.90	6.00	600	1.2	0.3	1.46	475

$T_j = 125^{\circ}$ C

SWITCHING TRANSISTORS (cont'd)

TO-3 (cont'd)

V _{CEO} (V)	V _{CE0} (V)	I _C (A)	TYPE	Complementary	V _{CEsat} [ⓐ] (V)	I _C (A)	I _B (mA)	t _s [ⓐ] (μs)	t _f (μs)	R _{thj-c} (°C/W)	Page
300	200	20	BUV51		0.90	10.00	1000	1.4	0.3	1.17	505
300	200	40	BUR21		0.60	12.00	1200				363
300	200	50	BUT91		1.20	40.00	4000	1.2	0.3	0.7	397
300	200	50	BUV61		0.90	25.00	2500	1.2	0.3	0.7	537
300	200	60	BUR51		1.00	30.00	2000	2	0.6	0.5	371
300	250	12	BUX42		1.20	4.00	400	2	1.2	1.46	727
300	250	20	BUX12		1.00	5.00	500	2	0.5	1.17	679
300	250	40	BUV22		1.00	10.00	1000	2	0.5	0.7	433
300	250	40	BUX22		1.00	10.00	1000	2	0.5	0.5	695
350	250	12	BUV42		0.90	4.00	400	1.6	0.3	1.46	483
350	250	20	BUV52		0.90	8.00	800	1.6	0.3	1.17	513
350	250	40	BUR22		1.00	10.00	1000				365
350	250	40	BUV62		0.90	16.00	1600	1.8	0.35	0.7	545
350	250	50	BUT92		1.20	35.00	3500	3▲	0.4▲	0.7	405
350	250	60	BUR52		1.80	25.00	2000	2	0.6	0.5	375
400	300	12	BUV42A		0.90	4.00	400	3▲	0.4▲	1.46	491
400	300	20	BUV52A		0.90	7.00	700	3▲	0.4▲	1.17	521
400	300	40	BUV62A		0.90	15.00	1500	3▲	0.4▲	0.7	553
400	300	50	BUT102		0.90	40.00	4000	3▲	0.4▲	0.7	421
400	300	50	BUT92A		0.90	30.00	3000	3▲	0.4▲	0.7	411
400	325	10	BUX43		2.00	5.00	1000	2.2	1.2	1.46	731
400	325	15	BUX13		1.50	8.00	1600	3	1.2	1.17	683
400	325	30	BUV23		1.00	16.00	3200	2.5	1.2		437
400	325	30	BUX23		1.00	16.00	3200	2.5	1.2	0.5	699
400	350	10		BUW32	1.50	5.00	1500	1.5	0.6	1.2	569
400	350	15		BUW42	1.50	10.00	3000	1.5	0.6	1	593
400	350	20	MJ10004		1.90	10.00	400	1.5	0.5	1	823
450	300	8	2N6671		1.00	5.00	1000	2.5	0.4	1.17	1167
450	300	15	2N6674		1.00	10.00	2000	2.5	0.5	1	1171
450	300	15	2N6676		1.00	15.00	3000	2.5	0.5	1	1175
450	400	8	BUX44		1.50	4.00	800	2.5	1.2	1.46	733
450	400	10		BUW32A	1.50	5.00	1500	1.5	0.6	1.2	569
450	400	10	BUX14		1.60	6.00	1200	3	1.2	1.17	685
450	400	15		BUW42A	1.50	10.00	3000	1.5	0.6	1	593
450	400	20	BUV24		1.00	12.00	2400	3	1.4	0.7	437
450	400	20	BUX24		1.00	12.00	2400	3	1.4	0.7	705
450	400	20	MJ10005		1.90	10.00	400	1.5	0.5	1	823
500	200	10	BUY69C		3.3	8.00	2500	1.7●	0.3●	1.75	799
500	400	10	BUW34		1.50	5.00	1000	3	0.8	1.4	575
500	400	15	BUW44		3.00	10.00	2000	3	0.8	1	597
500	500	15	BUV25		1.00	8.00	1600	5	1.6	0.7	437
500	500	30	BUX25		1.00	8.00	1600	5	1.2	0.5	711
550	350	8	2N6672		1.00	5.00	1000	2.5	0.4	1.17	1167
550	350	15	2N6677		1.00	15.00	3000	2.5	0.5	1	1175

▲ Inductive load

● Typical value

SWITCHING TRANSISTORS (cont'd)

TO-3(cont'd)

V_{CE0} (V)	V_{CEO} (V)	I_C (A)	TYPE	Complementary	V_{CEsat} [@] (V)	I_C (A)	I_B (mA)	t_s [@] (μ s)	t_f (μ s)	R_{thj-c} ($^{\circ}$ C/W)	Page
600	400	28	BUT13		2.00	10.00	500	1.5	0.6	1	385
600	400	28	SGSD310		2.50	18.00	1800	1.5	0.5	1	889
650	300	8	2N6544		1.5	5.00	1000	4	0.9	1.4	1163
650	400	8	2N6673		1.00	5.00	1000	2.5	0.4	1.17	1167
650	400	15	2N6675		1.00	10.00	2000	2.5	0.5	1	1171
650	400	15	2N6678		1.00	15.00	3000	2.5	0.5	1	1175
650	400	28	SGSD00031		2.50	12.00	100	1.5	0.5	1	897
800	325	10	BUY69B		3.3	8.00	2500	1.7●	0.3●	1.75	799
800	400	10	BUX80		1.5	5.00	1000	3.5	0.5	1.75	761
800	400	10	BUW35		1.50	5.00	1000	3	0.8	1.4	575
800	400	15	BUW45		1.50	10.00	2000	3	0.8	1	597
800	500	20	MJ13335		1.8	10.00	2000			*	
850	400	8	2N6545		1.5	5.00	1000	4	0.9	1.4	1163
850	400	9	BUX47		1.5	6.00	1200	2.5	0.8	1.2	735
850	400	10	SGSF541		1.5	6.00	1200	2.5	0.35	1.3	931
850	400	15	BUX48		1.5	10.00	2000	3	0.8	1	745
850	400	15	SGSF561		1.5	10.00	2000	2.3	0.5	1	955
850	400	30	BUX98		1.5	20.00	4000	3	0.8	0.7	767
850	400	30	SGSF661		1.5	20.00	4000	2.3	0.5	0.6	979
850	450	30	BUF420M		0.5●	20.00	4000				357
850	450	45	BUX348		0.9	30.00	6000			0.58	779
900	400	6	BU326A		1.5	2.50	500	3.5	0.5	2.33	281
900	450	10	BUW36		1.50	5.00	1000	3	0.8	1.4	575
900	450	15	BUW46		1.50	10.00	2000	3	0.8	1	597
1000	400	10	BUY69A		3.3	8.00	2500	1.7●	0.3●	1.75	799
1000	450	8	SGSF543		1.5	4.50	900	2.5	0.35	1.3	937
1000	450	9	BUX47A		1.5	5.00	1000	2.5	0.8	1.2	735
1000	450	12	SGSF563		1.5	7.00	1400	2.3	0.5	1	961
1000	450	15	BUX48A		1.5	8.00	1600	3	0.8	1	745
1000	450	24	SGSF663		1.5	14.00	2800	2.3	0.5	0.6	983
1000	450	30	BUF420AM		0.5●	20.00	4000				357
1000	450	30	BUX98A		1.5	16.00	3200	3	0.8	0.7	767
1200	600	7	SGSF544		1.5	3.50	0.70	3.5	0.3	1.3	943
1200	600	8	2ST3412		5.0	5.00	1.00			*	
1200	600	10	SGSF564		1.5	6.00	1.20	3.5	0.4	1	967
1200	600	15	BUX48B		1.5	6.00	1.50	3	0.7	1	755
1200	600	20	SGSF664		1.5	12.00	2.40	3.5	0.4	0.6	987
1200	600	30	BUX98B		1.5	12.00	3.00	3	0.8	0.7	769
1200	700	15	BUX48C		1.5	6.00	1.50	3	0.7	1	755
1200	700	30	BUX98C		1.5	12.00	3.00	3	0.8	0.7	769
1300	500	8	2SC3412		5.0	5.00	1.00			*	
1300	600	10	SGSF565		1.5	5.00	1.00	3.5	0.4	1	973
1300	600	20	SGSF665		1.5	10.00	2.00	3.5	0.4	0.6	991
1500	600	2.5	2SD818		8.0	2.00	0.60			*	

* Datasheet on request

● Typical value

SELECTION GUIDE BY PACKAGE

SWITCHING TRANSISTORS (cont'd)

TO-3(cont'd)

V _{CEO} (V)	V _{CE0} (V)	I _C (A)	TYPE	Complementary	V _{CEsat} [@] (V)	I _C (A)	I _B (mA)	t _s (μs)	t _f (μs)	R _{thj-c} (°C/W)	Page
1500	600	3.5	2SD819		8.0	3.00	0.80				*
1500	600	3.5	2SD869		8.0	3.00	0.80				*
1500	700	3	2ST1942		5.0	2.50	0.80				*
1500	700	8	BU208		5.0	4.50	2.00	7●	0.55●	1	267
1500	700	8	BU208A		1.0	4.50	2.00	7●	0.55●	1	267
1500	700	8	BU208D		1.0	4.50	2.00	7●	0.55●	1	267

ISOTOP

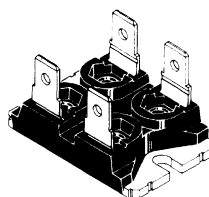
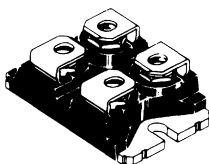

V _{CEO} (V)	V _{CE0} (V)	I _C (A)	TYPE	Complementary	V _{CEsat} [@] (V)	I _C (A)	I _B (mA)	t _s (μs)	t _f (μs)	R _{thj-c} (°C/W)	Page
150	125	120	ESM2012D(V)		1.5#	70	250	2▲	0.4▲	0.7	*
200	125	100	BUT30(V)		0.9	100	10000	2▲	0.2▲	0.5	*
200	125	200	BUT230(V)		0.9	200	20000	2▲	0.2▲	0.41	*
400	300	67	ESM2030D(V)		2.0#	56	1600	3.5▲	0.7▲	0.83	*
400	300	80	BUT32(V)		0.9	40	4000	3▲	0.4▲	0.5	*
400	300	100	ESM3030D(V)		1.7#	60	600	3.5▲	0.7▲	0.83	*
600	450	24	ESM3045D(V)		2.0#	15	300	4▲	0.4▲	1	*
600	450	42	ESM4045D(V)		2.0#	25	500	4.5▲	0.5▲	0.83	*
600	450	60	ESM5045D(V)		2.0#	35	700	5▲	0.5▲	0.71	*
600	450	75	ESM7545D(V)		2.5	75	1500	5▲	1▲	0.41	*
600	450	84	ESM6045D(V)		2.0#	50	1000	5.5▲	0.5▲	0.5	*
850	450	30	BUV98(V)		1.5	20	4000	5▲	0.4▲	0.83	*
850	450	60	BUV298(V)		1.2	40	8000	4.5▲	0.4▲	0.5	*
850	450	90	BUF460(V)		2.0#	60	12000	3.5▲	0.12▲	0.41	*
1000	450	24	ESM3045A(V)		2.0#	18	720	4.5▲	0.5▲	1	*
1000	450	30	BUV98A(V)		1.5	16	3200	5▲	0.4▲	0.83	*
1000	450	42	ESM4045A(V)		2.0#	30	1200	5▲	0.6▲	0.83	*
1000	450	50	BUV298A(V)		1.2	32	6400	4.5▲	0.4▲	0.5	*
1000	450	84	ESM6045A(V)		2.0#	60	2400	6▲	0.6▲	0.5	*
1000	450	90	BUF460A(V)		2.0#	60	12000	3.5▲	0.12▲	0.41	*
1000	700	50	ESMT5070D(V)		3.0	50	500	15▲	3▲	0.41	*
1200	700	30	BUV98C(V)		1.5	12	3000	6▲	0.6▲	0.83	*

▲ Inductive load

● Typical value

T_J = 125°C

■ T_J = 100°C

* Datasheet available on request

INDUSTRY STANDARD	SGS-THOMSON	SGS-THOMSON NEAREST	PAGE	INDUSTRY STANDARD	SGS-THOMSON	SGS-THOMSON NEAREST	PAGE
BD135	BD135		133	BD203		BD707	179
BD136	BD136		137	BD204		BD708	179
BD137	BD137		133	BD205		BD905	185
BD138	BD138		137	BD206		BD906	185
BD139	BD139		133	BD207		BD907	185
BD140	BD140		137	BD208		BD908	185
BD142		2N3055	1039	BD213-45		2N6486	1157
BD144		BUX47	735	BD213-60		2N6487	1157
BD157	BD157		141	BD213-80		2N6488	1157
BD158	BD158		141	BD214-45		2N6489	1157
BD159	BD159		141	BD214-60		2N6490	1157
BD160		2N5878	1115	BD214-80		2N6491	1157
BD165		BD437	163	BD220		BD537	171
BD166		BD438	163	BD221		BD533	171
BD167		BD439	169	BD222		BD535	171
BD168		BD440	169	BD223		BD538	171
BD169		BD441	169	BD224		BD534	171
BD170		BD442	169	BD225		BD536	171
BD171		BD237	149	BD226		BD175	143
BD172		BD238	149	BD227		BD176	143
BD173		BD325	*	BD228		BD177	143
BD175	BD175		143	BD229		BD178	143
BD176	BD176		143	BD230		BD179	143
BD177	BD177		143	BD231		BD180	143
BD178	BD178		143	BD232		MJE3489	*
BD179	BD179		143	BD233	BD233		149
BD180	BD180		143	BD234	BD234		149
BD181		2N3715	1047	BD235	BD235		149
BD182		2N3715	1047	BD236	BD236		149
BD183		2N3716	1047	BD237	BD237		149
BD184		2N3716	1047	BD238	BD238		149
BD185		BD435	163	BD239	BD239		153
BD186		BD436	163	BD239A	BD239A		153
BD187		BD437	163	BD239B	BD239B		153
BD188		BD438	163	BD239C	BD239C		153
BD189		BD439	169	BD240	BD240		153
BD190		BD440	169	BD240A	BD240A		153
BD195		BD533	171	BD240B	BD240B		153
BD196		BD534	171	BD240C	BD240C		153
BD197		BD535	171	BD241	BD241		155
BD198		BD536	171	BD241A	BD241A		155
BD199		BD537	171	BD241B	BD241B		155
BD200		BD538	171	BD241C	BD241C		155
BD201		BD705	179	BD242	BD242		155
BD202		BD706	179	BD242A	BD242A		155

* Datasheet available on request

CROSS REFERENCE

INDUSTRY STANDARD	SGS-THOMSON	SGS-THOMSON NEAREST	PAGE	INDUSTRY STANDARD	SGS-THOMSON	SGS-THOMSON NEAREST	PAGE
BD242B	BD242B		155	BD267		BDX53A	217
BD242C	BD242C		155	BD267A		BDX53B	217
BD243	BD243		157	BD267B		BDX53C	217
BD243A	BD243A		157	BD268		BDW94A	205
BD243B	BD243B		157	BD268A		BDW94B	205
BD243C	BD243C		157	BD269		BDW93A	205
BD244	BD244		157	BD269A		BDW93B	205
BD244A	BD244A		157	BD271		BD533	171
BD244B	BD244B		157	BD272		BD534	171
BD244C	BD244C		157	BD273		BD535	171
BD245	TIP33A		999	BD274		BD536	171
BD245A	TIP33A		999	BD275		BD537	171
BD245B	TIP33B		999	BD276		BD538	171
BD245C	TP33C		999	BD277		BD708	179
BD246	TIP34A		999	BD278		BD707	179
BD246A	TIP34A		999	BD278A		BD707	179
BD246B	TIP34B		999	BD301		BD533	171
BD246C	TIP34C		999	BD302		BD534	171
BD249	TIP35A		1001	BD303		BD535	171
BD249A	TIP35A		1001	BD304		BD536	171
BD249B	TIP35B		1001	BD311		BDW51A	193
BD249C	TIP35C		1001	BD312		BDW52A	193
BD250	TIP36A		1001	BD313		BDW51B	193
BD250A	TIP36A		1001	BD314		BDW52B	193
BD250B	TIP36B		1001	BD331	BD331		159
BD250C	TIP36C		1001	BD332	BD332		159
BD253		BU326	281	BD333	BD333		159
BD253A		BU326	281	BD334	BD334		159
BD253B		BU326	281	BD335	BD335		159
BD253C		BU326A	281	BD336	BD336		159
BD262		BD678	175	BD361		BD433	163
BD262A		BD680	175	BD361A		BD433	163
BD262B		BD682	175	BD362		BD434	163
BD263		BD677	175	BD362A		BD434	163
BD363A		BD679	175	BD375		BD235	149
BD263B		BD681	175	BD376		BD236	149
BD264		BDX34A	211	BD377		BD237	149
BD264A		BDX34B	211	BD378		BD238	149
BD264B		BDX34C	211	BD379		BD237	149
BD265		BDX33B	211	BD380		BD238	149
BD265A		BDX33B	211	BD410		MJE3439	855
BD265B		BDX33C	211	BD433	BD433		163
BD266		BDX54A	217	BD434	BD434		163
BD266A		BDX54B	217	BD435	BD435		163
BD266B		BDX54C	217	BD436	BD436		163

* Datasheet available on request

INDUSTRY STANDARD	SGS-THOMSON	SGS-THOMSON NEAREST	PAGE	INDUSTRY STANDARD	SGS-THOMSON	SGS-THOMSON NEAREST	PAGE
BD437	BD437		163	BD575		BD533	171
BD438	BD438		163	BD576		BD534	171
BD439	BD439		169	BD577		BD535	171
BD440	BD440		169	BD578		BD536	171
BD441	BD441		169	BD579		BD537	171
BD442	BD442		169	BD580		BD538	171
BD450		2N3055	1039	BD581		MJE182	829
BD451		2N3055	1039	BD582		MJE172	829
BD500		BD908	185	BD585		BD533	171
BD500A		BD910	185	BD586		BD534	171
BD500B		BD910	185	BD587		BD535	171
BD501		BD907	185	BD588		BD536	171
BD501A		BD909	185	BD589		BD537	171
BD501B		BD909	185	BD590		BD538	171
BD533	BD533		171	BD591		MJE182	829
BD534	BD534		171	BD592		MJE172	829
BD535	BD535		171	BD595		BD701	*
BD536	BD536		171	BD596		BD708	179
BD537	BD537		171	BD597		BD707	179
BD538	BD538		171	BD598		BD708	179
BD539		BD241	155	BD599		BD709	179
BD539A		BD241A	155	BD600		BD710	179
BD539B		BD241B	155	BD601		BD711	179
BD539C		BD241C	155	BD602		BD712	179
BD540		BD242	155	BD605		BD907	185
BD540A		BD242A	155	BD606		BD908	185
BD540B		BD242B	155	BD607		BD907	185
BD540C		BD242C	155	BD608		BD908	185
BD543		BD905	185	BD609		BD909	185
BD543A		BD907	185	BD610		BD910	185
BD5423B		BD909	185	BD633		BD533	171
BD544		BD906	185	BD634		BD534	171
BD544A		BD908	185	BD635		BD535	171
BD544B		BD910	185	BD636		BD536	171
BD545		TIP35A	1001	BD637		BD537	171
BD545A		TIP35A	1001	BD638		BD538	171
BD545B		TIP35B	1001	BD643		BDX53	217
BD545C		TIP35C	1001	BD644		BDX54	217
BD546		TIP36A	1001	BD645		BDX53A	217
BD546A		TIP36A	1001	BD646		BDX54A	217
BD546B		TIP36B	1001	BD647		BDX53B	217
BD546C		TIP36C	1001	BD648		BDX54B	217
BD550B		BUX42	727	BD649		BDX53C	217
BD561		BD437	163	BD650		BDX54C	217
BD562		BD438	163	BD651		BDX53E	219

* Datasheet available on request

CROSS REFERENCE

INDUSTRY STANDARD	SGS-THOMSON	SGS-THOMSON NEAREST	PAGE	INDUSTRY STANDARD	SGS-THOMSON	SGS-THOMSON NEAREST	PAGE
BD652		BDX54E	219	BD745		TIP35A	1001
BD663		2N6488	1157	BD745A		TIP35A	1001
BD664		2N6491	1157	BD745B		TIP35B	1001
BD675	BD675		175	BD745C		TIP35C	1001
BD676	BD676		175	BD746		TIP36A	1001
BD677	BD677		175	BD746A		TIP36A	1001
BD678	BD678		175	BD746B		TIP36B	1001
BD679	BD679		175	BD746C		TIP36C	1001
BD680	BD680		175	BD795		BD707	179
BD681	BD681		175	BD796		BD708	179
BD682	BD682		175	BD797		BD707	179
BD695A		BDX53	217	BD798		BD708	179
BD696A		BDX54	217	BD799		BD709	179
BD697		BDX53A	217	BD800		BD710	179
BD697A		BDX53A	217	BD801		BD711	179
BD698		BDX54A	217	BD802		BD712	179
BD698A		BDX54A	217	BD805		BD907	185
BD699		BDX53B	217	BD806		BD908	185
BD699A		BDX53B	217	BD807		BD907	185
BD700		BDX54B	217	BD808		BD908	185
BD700A		BDX54B	217	BD809		BD909	185
BD701		BDX53C	217	BD810		BD910	185
BD702		BDX54C	217	BD875		BD675	175
BD705	BD705		179	BD876		BD676	175
BD706	BD706		179	BD877		BD677	175
BD707	BD707		179	BD878		BD678	175
BD708	BD708		179	BD879		BD679	175
BD709	BD709		179	BD880		BD680	175
BD710	BD710		179	BD895		BDW93	205
BD711	BD711		179	BD895A		BDW93	205
BD712	BD712		179	BD896		BDW94	205
BD733		BD533	171	BD896A		BDW94	205
BD734		BD534	171	BD897		BDW93A	205
BD735		BD533	171	BD897A		BDW93A	205
BD736		BD534	171	BD898		BDW94A	205
BD737		BD533	171	BD898A		BDW94A	205
BD738		BD534	171	BD899		BDW93B	205
BD743		BD911	185	BD899A		BDW93B	205
BD743A		BD911	185	BD900		BDW94B	205
BD743B		BD911	185	BD900A		BDW94B	205
BD743C		BD911	185	BD901		BDW94C	205
BD744		BD912	185	BD902		BDW94C	205
BD744A		BD912	185	BD905	BD905		185
BD744B		BD912	185	BD906	BD906		185
BD744C		BD912	185	BD907	BD907		185

* Datasheet available on request

CROSS REFERENCE

INDUSTRY STANDARD	SGS-THOMSON	SGS-THOMSON NEAREST	PAGE	INDUSTRY STANDARD	SGS-THOMSON	SGS-THOMSON NEAREST	PAGE
BD908	BD908		185	BDT42		TIP42	1003
BD909	BD909		185	BDT42A		TIP42A	1003
BD910	BD910		185	BDT42B		TIP42B	1003
BD911	BD911		185	BDT42C		TIP42C	1003
BD912	BD912		185	BDT60		TIP115	1017
BD933		BD239	153	BDT60A		TIP116	1017
BD934		BD240	153	BDT60B		TIP117	1017
BD935		BD239A	153	BDT61		TIP110	1017
BD936		BD240A	153	BDT61A		TIP111	1017
BD937		BD239B	153	BDT61B		TIP112	1017
BD938		BD240B	153	BDT62		BDW94A	205
BD939		BD239C	153	BDT62A		BDW94B	205
BD940		BD240C	153	BDT62B		BDW94C	205
BD943		BD533	171	BDT63		BDW93A	205
BD944		BD534	171	BDT63A		BDW93B	205
BD945		BD533	171	BDT63B		BDW93C	205
BD946		BD534	171	BDT64		TIP145T	1035
BD947		BD533	171	BDT64A		TIP146T	1035
BD948		BD534	171	BDT64B		TIP147T	1035
BD949		BD241A	155	BDT65		TIP140T	1035
BD950		BD242A	155	BDT65A		TIP141T	1035
BD951		BD241B	155	BDT 65B		TIP142T	1035
BD952		BD242B	155	BDT91		BD907	185
BD953		BD241C	155	BDT92		BD908	185
BD954		BD242C	155	BDT93		BD909	185
BDT29		TIP31	995	BDT94		BD910	185
BDT29A		TIP31A	995	BDT95		BD911	185
BDT29B		TIP31B	995	BDT96		BD912	185
BDT29C		TIP31C	995	BDV64	BDV64		189
BDT30		TIP32	995	BDV64A	BDV64A		189
BDT30A		TIP32A	995	BDV64B	BDV64B		189
BDT30B		TIP32B	995	BDV65	BDV65		189
BDT30C		TIP32C	995	BDV65A	BDV65A		189
BDT31		TIP31	995	BDV65B	BDV65B		189
BDT31A		TIP31A	995	BDV66		BDW84A	199
BDT31B		TIP31B	995	BDV66A		BDW84B	199
BDT31C		TIP31C	995	BDV66B		BDW84C	199
BDT32		TIP32	995	BDV67		BDW85A	*
BDT32A		TIP32A	995	BDV67A		BDW85B	*
BDT32B		TIP32B	995	BDV67B		BDW85C	*
BDT32C		TIP32C	995	BDV91		TIP33A	999
BDT41		TIP41	1003	BDV92		TIP34A	999
BDT41A		TIP41A	1003	BDV93		TIP33B	999
BDT41B		TIP41B	1003	BDV94		TIP34B	999
BDT41C		TIP41C	1003	BDV95		TIP33C	999

* Datasheet available on request

CROSS REFERENCE

INDUSTRY STANDARD	SGS-THOMSON	SGS-THOMSON NEAREST	PAGE	INDUSTRY STANDARD	SGS-THOMSON	SGS-THOMSON NEAREST	PAGE
BDV96		TIP34C	999	BDW64		BDX54	217
BDW21		BDW51	193	BDW64A		BDX54A	217
BDW21A		BDW51A	193	BDW64B		BDX54B	217
BDW21B		BDW51B	193	BDW64C		BDX54C	217
BDW21C		BDW51C	193	BDW73		BDW93	205
BDW22		BDW52	193	BDW73A		BDW93A	205
BDW22A		BDW52A	193	BDW73B		BDW93B	205
BDW22B		BDW52B	193	BDW73C		BDW93C	205
BDW22C		BDW52C	193	BDW74		BDW94	205
BDW23		BDX53	217	BDW74A		BDW94A	205
BDW23A		BDX53A	217	BDW74B		BDW94B	205
BDW23B		BDX53B	217	BDW74C		BDW94C	205
BDW23C		BDX53C	217	BDW83	BDW83		199
BDW24		BDX54	217	BDW83A	BDW83A		199
BDW24A		BDX54A	217	BDW83B	BDW83B		199
BDW24B		BDX54B	217	BDW83C	BDW83C		199
BDW24C		BDX54C	217	BDW84	BDW84		199
BDW39		TIP140T	1035	BDW84A	BDW84A		199
BDW40		TIP140T	1035	BDW84B	BDW84B		199
BDW41		TIP141T	1035	BDW84C	BDW84C		199
BDW42		TIP142T	1035	BDW91	BDW91		201
BDW44		TIP145T	1035	BDW92	BDW92		201
BDW45		TIP145T	1035	BDW93	BDW93		205
BDW46		TIP146T	1035	BDW93A	BDW93A		205
BDW47		TIP147T	1035	BDW93B	BDW93B		205
BDW51	BDW51		193	BDW93C	BDW93C		205
BDW51A	BDW51A		193	BDW94	BDW94		205
BDW51B	BDW51B		193	BDW94A	BDW94A		205
BDW51C	BDW51C		193	BDW94B	BDW94B		205
BDW52	BDW52		193	BDW94C	BDW94C		205
BDW52A	BDW52A		193	BDX13		BDW51A	193
BDW52B	BDW52B		193	BDX18		BDW52B	193
BDW52C	BDW52C		193	BDX33	BDX33		211
BDW53		TIP110T	*	BDX33A	BDX33A		211
BDW53A		TIP110T	*	BDX33B	BDX33B		211
BDW53B		TIP111T	*	BDX33C	BDX33C		211
BDW53C		TIP112T	*	BDX34	BDX34		211
BDW54		TIP115T	*	BDX34A	BDX34A		211
BDW54A		TIP115T	*	BDX34B	BDX34B		211
BDW54B		TIP116T	*	BDX34C	BDX34C		211
BDW54C		TIP117T	*	BDX42		BD677	175
BDW63		BDX53	217	BDX43		BD679	175
BDW63A		BDW53A	*	BDX44		BD681	175
BDW63B		BDX53B	217	BDX45		BD678	175
BDW63C		BDX53C	217	BDX46		BD680	175

* Datasheet available on request

CROSS REFERENCE

INDUSTRY STANDARD	SGS-THOMSON	SGS-THOMSON NEAREST	PAGE	INDUSTRY STANDARD	SGS-THOMSON	SGS-THOMSON NEAREST	PAGE
BDX47		BD682	175	BDX78		BD710	179
BDX53	BDX53		217	BDX83		BDX87	233
BDX53A	BDX53A		*	BDX83A		BDX87A	233
BDX53B	BDX53B		*	BDX83B		BDX87B	233
BDX53C	BDX53C		217	BDX83C		BDX87C	233
BDX53D	BDX53D		*	BDX84		BDX88	233
BDX53E	BDX53E		219	BDX84A		BDX88A	233
BDX53F	BDX53F		219	BDX84B		BDX88B	233
BDX53S	BDX53S		223	BDX84C		BDX88C	233
BDX54	BDX54		217	BDX85	BDX85		227
BDX54A	BDX54A		217	BDX85A	BDX85A		227
BDX54B	BDX54B		217	BDX85B	BDX85B		227
BDX54C	BDX54C		217	BDX85C	BDX85C		227
BDX54D	BDX54D		*	BDX86	BDX86		227
BDX54E	BDX54E		219	BDX86A	BDX86A		227
BDX54F	BDX54F		219	BDX86B	BDX86B		227
BDX54S	BDX54S		223	BDX86C	BDX86C		227
BDX62		BDX86A	227	BDX87	BDX87		233
BDX62A		BDX86B	227	BDX87A	BDX87A		233
BDX62B		BDX86C	227	BDX87B	BDX87B		233
BDX63		BDX85A	227	BDX87C	BDX87C		233
BDX63A		BDX85B	227	BDX88	BDX88		233
BDX63B		BDX85C	227	BDX88A	BDX88A		233
BDX64		BDX88A	233	BDX88B	BDX88B		233
BDX64A		BDX88B	233	BDX88C	BDX88C		233
BDX64B		BDX88C	233	BDX91		BDW51A	193
BDX65		BDX87A	233	BDX92		BDW52A	193
BDX65A		BDX87B	233	BDX93		BDW51B	193
BDX65B		BDX87C	233	BDX94		BDW52B	193
BDX66		MJ2500	817	BDX95		BDW51C	193
BDX66A		MJ2501	817	BDX96		BDW52C	193
BDX66B		MJ4032	821	BDY45		BDX48	*
BDX67		MJ3000	817	BDY46		BDX48	*
BDX67A		MJ3001	817	BDY47		BDX48	*
BDX67B		MJ4035	821	BDY53		BDY57	239
BDX68		MJ11011	825	BDY54		BDY58	239
BDX68A		MJ11013	825	BDY55		BDY57	239
BDX68B		MJ11015	825	BDY56		BDY58	239
BDX68C		MJ11015	825	BDY57	BDY57		239
BDX69		MJ11012	825	BDY58	BDY58		239
BDX69A		MJ11014	825	BDY76		2N3772	1053
BDX69B		MJ11016	825	BDY80		BD241	155
BDX69C		MJ11016	825	BDY81		BD241A	155
BDX71		2N6487	1157	BDY82		BD242	155
BDX77		BD709	179	BDY83		BD242A	155

* Datasheet available on request

CROSS REFERENCE

INDUSTRY STANDARD	SGS-THOMSON	SGS-THOMSON NEAREST	PAGE	INDUSTRY STANDARD	SGS-THOMSON	SGS-THOMSON NEAREST	PAGE
BDY90	BDY90		241	BU406	BU406		285
BDY91	BDY91		241	BU406D	BU406D		291
BDY92	BDY92		241	BU406H	BU406H		285
BDY93		BU326	281	BU407	BU407		297
BDY94		BU326	281	BU407D	BU407D		291
BDY95		BU326	281	BU407H	BU407H		297
BDY96		BUX47	735	BU408	BU408		285
BDY87		2N6672	1167	BU408D	BU408D		291
BDY98		2N6671	1167	BU411		BU607D	*
BFX34	BFX34		243	BU412		BU607D	*
BSS44	BSS44		247	BU426	BU426		303
BSW67	BSW67		251	BU426A	BU426A		303
BSW68	BSW68		251	BU508	BU508		267
BU104		BU606	*	BU508A	BU508A		267
BU104D		BU606D	*	BU508D	BU508D		271
BU104DP		BU406D	291	BU606	BU606		*
BU106		BU607	*	BU606D	BU606D		*
BU107		BU607	*	BU607	BU607		*
BU109		BU607	*	BU607D	BU607D		*
BU109D		BU607D	*	BU608	BU608		*
BU109DP		BU407D	291	BU608D	BU608D		*
BU110		BU607	*	BU801	BU801		307
BU111		BUW24	*	BU806	BU806		311
BU125	BU125		255	BU807	BU807		311
BU125S	BU125S		259	BU810	BU810		321
BU126		BU326	281	BU910	BU910		325
BU129		BU606	*	BU911	BU911		325
BU133		BU326	281	BU912	BU912		325
BU134		BU326	281	BU920	BU920		329
BU137		BUY69A	799	BU920P	BU920P		329
BU208	BU208		267	BU920T	BU920T		329
BU208A	BU208A		267	BU921	BU921		329
BU208D	BU208D		271	BU921P	BU921P		329
BU310		BU607	*	BU921T	BU921T		329
BU311		BU607	*	BU922	BU922		329
BU312		BU607	*	BU922P	BU922P		329
BU322		BU920	329	BU922T	BU922T		329
BU322A		BU922	329	BU930		BU930R	*
BU323		BU931R	337	BU930P		BU930RP	*
BU323A		BU932R	337	BU930Z		BU931Z	343
BU325	BU325		277	BU930ZP		BU931ZP	343
BU326	BU326		281	BU931		BU931R	337
BU326A	BU326A		281	BU931P		BU931RP	337
BU326S	BU326S		*	BU931R	BU931R		337
BU361		BUW35	575	BU931RP	BU931RP		337

* Datasheet available on request

INDUSTRY STANDARD	SGS-THOMSON	SGS-THOMSON NEAREST	PAGE	INDUSTRY STANDARD	SGS-THOMSON	SGS-THOMSON NEAREST	PAGE
BU932		BU932R	337	BUV39	BUV39		*
BU932P		BU932RP	337	BUV40	BUV40		467
BU932R	BU932R		337	BUV41	BUV41		475
BU932RP	BU932RP		337	BUV42	BUV42		483
BU999	BU999		347	BUV42A	BUV42A		491
BUR20	BUR20		361	BUV46	BUV46		495
BUR21	BUR21		363	BUV47	BUV47		735
BUR22	BUR22		365	BUV47A	BUV47A		735
BUR23	BUR23		*	BUV48	BUV48		745
BUR24	BUR24		*	BUV48A	BUV48A		745
BUR50	BUR50		367	BUV48B	BUV48B		755
BUR50S	BUR50S		367	BUV48C	BUV48C		755
BUR51	BUR51		371	BUV50	BUV50		497
BUR52	BUR52		375	BUV51	BUV51		505
BUS12		BUW35	575	BUV52	BUV52		513
BUS13		BUX48	*	BUV56	BUV56		525
BUS13A		BUW46	597	BUV60	BUV60		529
BUT11	BUT11		379	BUV61	BUV61		537
BUT11A	BUT11A		379	BUV62	BUV62		545
BUT13	BUT13		385	BUV62A	BUV62A		553
BUT13P	BUT13P		385	BUW11	BUW11		*
BUT55		BUT921T	*	BUW11A	BUW11A		*
BUT57		BUT931RP	*	BUW12	BUW12		561
BUT60	BUT60		*	BUW12A	BUW12A		561
BUT62	BUT62		*	BUW13	BUW13		*
BUT70	BUT70		*	BUW13A	BUW13A		*
BUT72	BUT72		*	BUW22		BUW22P	563
BUT90	BUT90		391	BUW22A		BUW22AP	563
BUT91	BUT91		397	BUW22AP	BUW22AP		563
BUT92	BUT92		405	BUW22P	BUW22P		563
BUT92A	BUT92A		411	BUW24	BUW24		*
BUT100	BUT100		417	BUW25	BUW25		*
BUT102	BUT102		421	BUW26	BUW26		*
BUV18	BUV18		425	BUW32	BUW32		569
BUV19	BUV19		425	BUW32A	BUW32A		569
BUV20	BUV20		433	BUW32AP	BUW32AP		569
BUV21	BUV21		433	BUW32P	BUW32P		569
BUV22	BUV22		433	BUW34	BUW34		575
BUV23	BUV23		437	BUW35	BUW35		575
BUV24	BUV24		437	BUW36	BUW36		575
BUV25	BUV25		437	BUW38	BUW38		583
BUV26	BUV26		441	BUW39	BUW39		583
BUV27	BUV27		447	BUW42	BUW42		593
BUV28	BUV28		453	BUW42A	BUW42A		593
BUV37	BUV37		*	BUW42AP	BUW42AP		593

* Datasheet available on request

CROSS REFERENCE

INDUSTRY STANDARD	SGS-THOMSON	SGS-THOMSON NEAREST	PAGE	INDUSTRY STANDARD	SGS-THOMSON	SGS-THOMSON NEAREST	PAGE
BUW42P	BUW42P		593	BUX22	BUX22		695
BUW44	BUW44		597	BUX23	BUX23		699
BUW45	BUW45		597	BUX24	BUX24		705
BUW46	BUW46		597	BUX25	BUX25		711
BUW48	BUW48		601	BUX28		BU920	329
BUW49	BUW49		601	BUX29		BU921	329
BUW50	BUW50		609	BUX37		BU931R	337
BUW51	BUW51		617	BUX40	BUX40		715
BUW52	BUW52		625	BUX41	BUX41		719
BUW57		BUX10	665	BUX41N	BUX41N		723
BUW58		BUX11N	675	BUX41S		BUX41	719
BUW60	BUW60		*	BUX42	BUX42		727
BUW61	BUW61		*	BUX43	BUX43		731
BUW62	BUW62		*	BUX44	BUX44		733
BUW66	BUW66		*	BUX46		BU236	*
BUW67	BUW67		*	BUX47	BUX47		735
BUW73		BUX11	671	BUX47A	BUX47A		735
BUW89	BUW89		633	BUX48	BUX48		745
BUW90	BUW90		641	BUX48A	BUX48A		745
BUW91	BUW91		649	BUX48B	BUX48B		755
BUW92	BUW92		657	BUX48C	BUX48C		755
BUX10	BUX10		665	BUX77	BUX77		*
BUX10P	BUX10P		669	BUX78	BUX78		*
BUX10S		BUX10	665	BUX80	BUX80		761
BUX11	BUX11		671	BUX82	BUX82		*
BUX11N	BUX11N		675	BUX84	BUX84		765
BUX11S		BUX11	671	BUX84A	BUX84A		765
BUX12	BUX12		679	BUX85	BUX85		*
BUX13	BUX13		683	BUX97B	BUX97B		*
BUX14	BUX14		685	BUX98	BUX98		767
BUX15		BUW44	597	BUX98A	BUX98A		767
BUX16		BUW24	*	BUX98B	BUX98B		769
BUX16A		BUW24	*	BUX98C	BUX98C		769
BUX16B		BUW24	*	BUX348	BUX348		779
BUX16C		BUW24	*	BUY18S	BUY18S		*
BUX17		BUX41N	723	BUY47	BUY47		785
BUX17A		BUX42	727	BUY48	BUY48		785
BUX17B		BUW44	597	BUY49P	BUY49P		789
BUX17C		BUW44	597	BUY49S	BUY49S		791
BUX18		BUX41	719	BUY57	BUX40		715
BUX18A		BUX42	727	BUY58	BUX41N		723
BUX18B		BUW35	575	BUY68	BUY68		795
BUX18C		BUW35	575	BUY69A	BUY69A		799
BUX20	BUX20		687	BUY69B	BUY69B		799
BUX20S	BUX20S		*	BUY69C	BUY69C		799

* Datasheet available on request

CROSS REFERENCE

INDUSTRY STANDARD	SGS-THOMSON	SGS-THOMSON NEAREST	PAGE	INDUSTRY STANDARD	SGS-THOMSON	SGS-THOMSON NEAREST	PAGE
D44C1	D44C1		801	MJ3042		BU922	329
D44C2	D44C2		801	MJ4030	MJ4030		821
D44C3	D44C3		801	MJ4031	MJ4031		821
D44C4	D44C4		801	MJ4032	MJ4032		821
D44C5	D44C5		801	MJ4033	MJ4033		821
D44C6	D44C6		801	MJ4034	MJ4034		821
D44C7	D44C7		801	MJ4035	MJ4035		821
D44C8	D44C8		801	MJ4502	MJ4502		809
D44C9	D44C9		801	MJ10000		BU931R	337
D44C10	D44C10		801	MJ10000		MJ10004	823
D44C11	D44C11		801	MJ10001		BU931R	337
D44H1	D44H1		803	MJ10001		MJ10005	823
D44H2	D44H2		803	MJ10002		BU920P	329
D44H4	D44H4		803	MJ10003		BU921P	329
D44H5	D44H5		803	MJ10004	MJ10004		823
D44H7	D44H7		803	MJ10004P	MJ10004P		823
D44H8	D44H8		803	MJ10005	MJ10005		823
D44H10	D44H10		803	MJ10005P	MJ10005P		823
D44H11	D44H11		803	MJ10012		BU931R	337
D44Q1	D44Q1		805	MJ11011	MJ11011		825
D44Q3	D44Q3		805	MJ11012	MJ11012		825
D44Q5	D44Q5		805	MJ11013	MJ11013		825
D45H1	D45H1		807	MJ11014	MJ11014		825
D45H2	D45H2		807	MJ11015	MJ11015		825
D45H4	D45H4		807	MJ11016	MJ11016		825
D45H5	D45H5		807	MJ13014		BUW34	575
D45H7	D45H7		807	MJ13015		BUW34	575
D45H8	D45H8		807	MJ13015		BUW34	575
D45H10	D45H10		807	MJ13330		BUX41	719
MJ424		BUW35	575	MJ13331		BUX42	727
MJ425		BUW35	575	MJ13332		BUV23	437
MJ802	MJ802		809	MJ13333		BUV24	437
MJ900	MJ900		815	MJ13334		BUV24	437
MJ901	MJ901		815	MJE170	MJE170		829
MJ1000	MJ1000		815	MJE171	MJE171		829
MJ1001	MJ1001		815	MJE172	MJE172		829
MJ2500	MJ2500		817	MJE180	MJE180		829
MJ2501	MJ2501		817	MJE181	MJE181		829
MJ2955	MJ2955		819	MJE182	MJE182		829
MJ3000	MJ3000		817	MJE200	MJE200		833
MJ3001	MJ3001		817	MJE210	MJE210		833
MJ3029		BUW24	*	MJE340	MJE340		837
MJ3030		BUW25	*	MJE350	MJE350		837
MJ3040		BU920	329	MJE371	MJE371		845
MJ3041		BU920	329	MJE520	MJE520		841

* Datasheet available on request

CROSS REFERENCE

INDUSTRY STANDARD	SGS-THOMSON	SGS-THOMSON NEAREST	PAGE	INDUSTRY STANDARD	SGS-THOMSON	SGS-THOMSON NEAREST	PAGE
MJE521	MJE521		845	SGS130	SGS130		1029
MJE700	MJE700		849	SGS131	SGS131		1029
MJE701	MJE701		849	SGS132	SGS132		1029
MJE702	MJE702		849	SGS135	SGS135		1029
MJE703	MJE703		849	SGS136	SGS136		1029
MJE800	MJE800		849	SGS137	SGS137		1029
MJE801	MJE801		849	SGS910	SGS910		*
MJE802	MJE802		849	SGS911	SGS911		*
MJE803	MJE803		849	SGS912	SGS912		*
MJE2955T	MJE2955T		853	SGS3055	SGS3055		*
MJE3055T	MJE3055T		853	SGS3439		MJE3439	855
MJE3439	MJE3439		855	SGS3440		MJE3440	855
MJE3440	MJE3440		855	SGS6386	SGS6386		*
MJE13002		SGS13002	877	SGS6387	SGS6387		*
MJE13003		SGS13003	877	SGS6388	SGS6388		*
MJE13004	MJE13004		859	SGS10004	SGS10004		*
MJE13005	MJE13005		859	SGS10004P	SGS10004P		*
MJE13006	MJE13006		863	SGS10005	SGS10005		*
MJE13007A	MJE13007A		863	SGS10005P	SGS10005P		*
MJE13008	MJE13008		871	SGS13002	SGS13002		877
MJE13009	MJE13009		871	SGS13002T	SGS13002T		877
SE9300		BDW93A	205	SGS13003	SGS13003		877
SE9301		BDW93B	205	SGS13003T	SGS13003T		877
SE9302		BDW93C	205	SGSD100	SGSD100		855
SE9303		BDX87A	233	SGSD200	SGSD200		855
SE9304		BDX87B	233	SGSD310	SGSD310		889
SE9305		BDX87C	233	SGSD311	SGSD311		889
SE9400		BDW94A	205	SGSD00020	SGSD00020		895
SE9401		BDW94B	205	SGSD00030	SGSD00030		897
SE9402		BDW94C	205	SGSD00031	SGSD00031		897
SE9403		BDX88A	233	SGSD000055	SGSD000055		905
SE9404		BDX88B	233	SGSF321	SGSF321		907
SE9405		BDX88C	233	SGSF323	SGSF323		913
SGS110	SGS110		1017	SGSF324	SGSF324		919
SGS111	SGS111		1017	SGSF341	SGSF341		931
SGS112	SGS112		1017	SGSF343	SGSF343		937
SGS115	SGS115		1017	SGSF344	SGSF344		943
SGS116	SGS116		1017	SGSF421	SGSF421		907
SGS117	SGS117		1017	SGSF423	SGSF423		913
SGS120	SGS120		*	SGSF424	SGSF424		919
SGS121	SGS121		*	SGSF425	SGSF425		925
SGS122	SGS122		*	SGSF441	SGSF441		931
SGS125	SGS125		*	SGSF443	SGSF443		937
SGS126	SGS126		*	SGSF444	SGSF444		943
SGS127	SGS127		*	SGSF445	SGSF445		949

* Datasheet available on request

INDUSTRY STANDARD	SGS-THOMSON	SGS-THOMSON NEAREST	PAGE	INDUSTRY STANDARD	SGS-THOMSON	SGS-THOMSON NEAREST	PAGE
SGSF461	SGSF461		955	TIP31A	TIP31A		995
SGSF463	SGSF463		961	TIP31B	TIP31B		995
SGSF464	SGSF464		967	TIP31C	TIP31C		995
SGSF465	SGSF465		973	TIP32	TIP32		995
SGSF541	SGSF541		931	TIP32A	TIP32A		995
SGSF543	SGSF543		937	TIP32B	TIP32B		995
SGSF544	SGSF544		943	TIP32C	TIP32C		995
SGSF545	SGSF545		949	TIP33	TIP33		*
SGSF561	SGSF561		955	TIP33A	TIP33A		999
SGSF563	SGSF563		961	TIP33B	TIP33B		999
SGSF564	SGSF564		967	TIP33C	TIP33C		999
SGSF565	SGSF565		973	TIP34	TIP34		*
SGSF661	SGSF661		979	TIP34A	TIP34A		999
SGSF663	SGSF663		983	TIP34B	TIP34B		999
SGSF664	SGSF664		987	TIP34C	TIP34C		999
SGSF665	SGSF665		991	TIP35	TIP35		1001
SGSIF321	SGSIF321		907	TIP35A	TIP35A		1001
SGSIF323	SGSIF323		913	TIP35B	TIP35B		1001
SGSIF324	SGSIF324		919	TIP35C	TIP35C		1001
SGSIF325	SGSIF325		925	TIP36A	TIP36A		1001
SGSIF341	SGSIF341		931	TIP36B	TIP36B		1001
SGSIF343	SGSIF343		937	TIP36C	TIP36C		1001
SGSIF344	SGSIF344		943	TIP41	TIP41		1003
SGSIF345	SGSIF345		949	TIP41A	TIP41A		1003
SGSIF421	SGSIF421		907	TIP41B	TIP41B		1003
SGSIF423	SGSIF423		913	TIP41C	TIP41C		1003
SGSIF424	SGSIF424		919	TIP42	TIP42		1003
SGSIF425	SGSIF425		925	TIP42A	TIP42A		1003
SGSIF441	SGSIF441		931	TIP42B	TIP42B		1003
SGSIF443	SGSIF443		937	TIP42C	TIP42C		1003
SGSIF444	SGSIF444		943	TIP47	TIP47		1005
SGSIF445	SGSIF445		949	TIP48	TIP48		1005
SGSIF461	SGSIF461		955	TIP49	TIP49		1005
SGSIF463	SGSIF463		961	TIP50	TIP50		1005
SGSIF464	SGSIF464		967	TIP51	TIP51		1009
SGSIF465	SGSIF465		973	TIP52	TIP52		1009
TIP29	TIP29		*	TIP53	TIP53		1009
TIP29A	TIP29A		*	TIP54	TIP54		1009
TIP29B	TIP29B		*	TIP73		BD905	185
TIP29C	TIP29C		*	TIP73A		BD907	185
TIP30	TIP30		*	TIP73B		BD909	185
TIP30A	TIP30A		*	TIP73C		BD911	185
TIP30B	TIP30B		*	TIP74		BD906	185
TIP30C	TIP30C		*	TIP74A		BD908	185
TIP31	TIP31		995	TIP74B		BD910	185

* Datasheet available on request

CROSS REFERENCE

INDUSTRY STANDARD	SGS-THOMSON	SGS-THOMSON NEAREST	PAGE	INDUSTRY STANDARD	SGS-THOMSON	SGS-THOMSON NEAREST	PAGE
TIP74C		BD912	185	2N3055	2N3055		1039
TP100	TIP100		1011	2N3418	2N3418		*
TIP101	TIP101		1011	2N3419	2N3419		*
TIP102	TIP102		1011	2N3420	2N3420		*
TIP105	TIP105		1011	2N3421	2N3421		*
TIP106	TIP106		1011	2N3439	2N3439		1043
TIP107	TIP107		1011	2N3440	2N3440		1043
TIP110	TIP110		1017	2N3445		BDW51A	193
TIP111	TIP111		1017	2N3446		BDW51B	193
TIP112	TIP112		1017	2N3553		BUY68	795
TIP115	TIP115		1017	2N3554		BUY68	795
TIP116	TIP116		1017	2N3713	2N3713		1047
TIP117	TIP117		1017	2N3714	2N3714		1047
TIP120	TIP120		1023	2N3715	2N3715		1047
TIP121	TIP121		1023	2N3716	2N3716		1047
TIP122	TIP122		1023	2N3719		BSS44	247
TIP125	TIP125		1023	2N3720		BSS44	247
TIP126	TIP126		1023	2N3771	2N3771		1053
TIP127	TIP127		1023	2N3772	2N3772		1053
TIP130	TIP130		1029	2N3789	2N3789		1047
TIP131	TIP131		1029	2N3790	2N3790		1047
TIP132	TIP132		1029	2N3791	2N3791		1047
TIP135	TIP135		1029	2N3792	2N3792		1047
TIP136	TIP136		1029	2N3830		BUY68	795
TIP137	TIP137		1029	2N3831		BUY68	795
TIP140	TIP140		1031	2N3924		BUY68	795
TIP140T	TIP140T		1035	2N4234	2N4234		1057
TIP141	TIP141		1031	2N4235	2N4235		1057
TIP141T	TIP141T		1035	2N4236	2N4236		1057
TIP142	TIP142		1031	2N4398	2N4398		*
TIP142T	TIP142T		1035	2N4399	2N4399		*
TIP145	TIP145		1031	2N4895	2N4895		1059
TIP145T	TIP145T		1035	2N4896	2N4896		1059
TIP146	TIP146		1031	2N4897	2N4897		1059
TIP146T	TIP146T		1035	2N4918	2N4918		1063
TIP147	TIP147		1031	2N4919	2N4919		1063
TIP147T	TIP147T		1035	2N4920	2N4920		1063
TIP150		BU910	325	2N4921	2N4921		1063
TIP151		BU910	325	2N4922	2N4922		1063
TIP152		BU911	325	2N4923	2N4923		1063
TIP660		BU920	329	2N5038	2N5038		1067
TIP661		BU920	329	2N5039	2N5039		1067
TIP662		BU921	329	2N5151	2N5151		1073
TIP2955	TIP2955		1037	2N5252	2N5252		1075
TIP3055	TIP3055		1037	2N5153	2N5153		1073

* Datasheet available on request

CROSS REFERENCE

INDUSTRY STANDARD	SGS-THOMSON	SGS-THOMSON NEAREST	PAGE	INDUSTRY STANDARD	SGS-THOMSON	SGS-THOMSON NEAREST	PAGE
2N5154	2N5154	BUW35	1075	2N5880		BDW52B	193
2N5157			575	2N5881		BDW51A	193
2N5190	2N5190		1077	2N5882		BDW51B	193
2N5191	2N5191		1077	2N5883	2N5883		1121
2N5192	2N5192		1077	2N5884	2N5884		1121
2N5193	2N5193		1077	2N5885	2N5885		1121
2N5194	2N5194		1077	2N5886	2N5886		1121
2N5195	2N5195		1077	2N6029	2N6029		1097
2N5301	2N5301		1083	2N6032	2N6032		1127
2N5302	2N5302		1083	2N6033	2N6033		1127
2N5303	2N5303	BSS44 BUY68 BUY47	1083	2N6034	2N6034		1131
2N5333			247	2N6035	2N6035		1131
2N5334			795	2N6036	2N6036		1131
2N5335			785	2N6037	2N6037		1131
2N5336	2N5336		1089	2N6038	2N6038		1131
2N5337	2N5337			1089	2N6039	2N6039	
2N5338	2N5338		1089	2N6040	2N6040		*
2N5339	2N5339		1089	2N6041	2N6041		*
2N5415	2N5415		1093	2N6042	2N6042		1135
2N5416	2N5416		1093	2N6043	2N6043		*
2N5490		BD705	179	2N6044	2N6044		*
2N5492		BD707	179	2N6045	2N6045		1135
2N5494		BD705	179	2N6050	2N6050		1137
2N5496		BD709	179	2N6051	2N6051		1137
2N5629	2N5629		1097	2N6052	2N6052		1137
2N5655	2N5655		1103	2N6053	2N6053		1139
2N5656	2N5656		1103	2N6054	2N6054		*
2N5657	2N5657		1103	2N6055	2N6055		1139
2N5671	2N5671		1107	2N6056	2N6056		*
2N5672	2N5672		1107	2N6057	2N6057		1137
2N5679	2N5679		1111	2N6058	2N6058		1137
2N5680	2N5680		1111	2N6059	2N6059		1137
2N5681	2N5681		1113	2N6107	2N6107		1140
2N5682	2N5682		1113	2N6109	2N6109		1140
2N5758		BDW51C	193	2N6111	2N6111		1140
2N5781		BSS44	247	2N6121	2N6121		1143
2N5782		BSS44	247	2N6122	2N6122		1143
2N5783		BSS44	247	2N6123	2N6123		1143
2N5784		BUY68	795	2N6124	2N6124		1143
2N5785		BUY68	795	2N6125	2N6125		1143
2N5875	2N5875		1115	2N6126	2N6126		1143
2N5876	2N5876		1115	2N6226		BDW52C	193
2N5877	2N5877		1115	2N6246		BDW52A	193
2N5878	2N5878		1115	2N6247		BDW52B	193
2N5879		BDW52A	193	2N6249		BUX41	719

* Datasheet available on request

CROSS REFERENCE

INDUSTRY STANDARD	SGS-THOMSON	SGS-THOMSON NEAREST	PAGE	INDUSTRY STANDARD	SGS-THOMSON	SGS-THOMSON NEAREST	PAGE
2N6250		BUX42	727	2N6514		BUW34	575
2N6251		BUW44	597	2N6531		BDX53C	217
2N6274		BUV20	433	2N6532		BDX53C	217
2N6275		BUV20	433	2N6544	2N6544		1163
2N6276		BUV21	433	2N6545	2N6545		1163
2N6277		BUV21	433	2N6546	2N6546		*
2N6282	2N6282		1149	2N6547	2N6547		*
2N6283	2N6283		1149	2N6569		BDW51	193
2N6284	2N6284		1149	2N6573		BUW44	597
2N6285	2N6285		1149	2N6574		2N6546	*
2N6286	2N6286		1149	2N6575		BUW45	597
2N6287	2N6287		1149	2N6594		BDW52	625
2N6288	2N6288		1140	2N6648		BDX88	233
2N6290	2N6290		1140	2N6649		BDX88A	233
2N6292	2N6292		1140	2N6650		BDXC88B	*
2N6306		BUW34	575	2N6666		BDX54	217
2N6307		BUW35	575	2N6667		BDX54A	217
2N6308		BUW35	575	2N6668		BDX54B	217
2N6338		BUX10	665	2N6702	2N6702		1179
2N6339		BUX10	665	2SA489		BD242B	155
2N6340		BUX11N	675	2SA490		BD242A	155
2N6341		BUX11N	675	2SA496		2N4918	1063
2N6383		BDX87	233	2SA505		2N4919	1063
2N6384		BDX87A	233	2SA626		BDW52B	193
2N6385		BDX87B	233	2SA627		BDW52B	193
2N6386	2N6386		1153	2SA657		BDW52C	193
2N6387	2N6387		1153	2SA658		BDW52B	193
2N6388	2N6388		1153	2SA663		BDW52C	193
2N6470		BDW51	193	2SA671		BD242A	155
2N6471		BDW51A	193	2SA680		BDW52B	193
2N6472		BDW51B	193	2SA682		BD180	143
2N6473		BD711	179	2SA699		TIP30	*
2N6475		BD712	179	2SA699A		TIP30A	*
2N6486	2N6486		1157	2SA700		TIP30	*
2N6487	2N6487		1157	2SA715		MJE170	829
2N6488	2N6488		1157	2SA738		MJE170	829
2N6489	2N6489		1157	2SA743		BD238	149
2N6490	2N6490		1157	2SA748		BD240B	153
2N6491	2N6491		1157	2SA755		BD240A	153
2N6496	2N6496		*	2SA756		BDW52C	193
2N6497	2N6497		1159	2SA768		BD242A	155
2N6498	2N6498		1159	2SA769		BD242B	155
2N6511		BUW34	575	2SA770		2N6109	1140
2N6512		BUW34	575	2SA771		2N6107	1140
2N6513		BUW34	575	2SA775		TIP30C	*

* Datasheet available on request

INDUSTRY STANDARD	SGS-THOMSON	SGS-THOMSON NEAREST	PAGE	INDUSTRY STANDARD	SGS-THOMSON	SGS-THOMSON NEAREST	PAGE
2SA779		BD438	169	2SB531		BDW52C	193
2SA780		BD440	169	2SB532		BDW52B	193
2SA780A		BD442	169	2SB536		MJE350	837
2SA795		MJE350	837	2SB553		TIP42B	1003
2SA807		2N3789	1047	2SB565		BD706	179
2SA808		2N3790	1047	2SB566		BD706	179
2SA815		TIP30C	*	2SB566A		BD706	179
2SA816		TIP30B	*	2SB569		BD676	175
2SA837		BDW52C	193	2SB570		BD678	175
2SA877		2N5876	1115	2SB571		BD680	175
2SA885		BD438	163	2SB572		2N5193	1077
2SA886		BD438	163	2SB573		2N5194	1077
2SA887		BD242B	155	2SB574		2N5195	1077
2SA898		MJE350	837	2SB575		2N5193	1077
2SA899		MJE350	837	2SB576		2N5194	1077
2SA900		MJE210	833	2SB577		2N5195	1077
2SA922		2N4918	1063	2SB578		MJ2955	819
2SA939		MJE350	837	2SB579		2N5875	1115
2SA963		MJE171	829	2SB580		2N5876	1115
2SA966		TIP32	995	2SB581		BDW52C	193
2SA1008		TIP32C	995	2SB585		2N6053	1139
2SA1010		TIP42C	1003	2SB586		2N6054	*
2SA1012		TIP42A	1003	2SB587		2N6050	1137
2SA1020		TIP32	995	2SB588		2N6051	1137
2SA1045		2N6052	1137	2SB589		2N6052	1137
2SA1046		2N6052	1137	2SB595		BD712	179
2SA1069		TIP42B	1003	2SB596		BD244B	157
2SA1110		MJE350	837	2SB604		BD244B	157
2SB434		BD244A	157	2SB631		2N4920	1063
2SB435		BD244	157	2SB632		MJE370	841
2SB507		BD242A	155	2SB633		TIP42C	1003
2SB509		BD244A	157	2SB638		BDX88C	233
2SB511		TIP32	995	2SB639		BDX88C	233
2SB513		2N6126	1143	2SB648		MJE350	837
2SB514		TIP32A	995	2SB655		BUW42	593
2SB515		TIP32A	995	2SB668		TIP32A	995
2SB518		BDW52C	193	2SB669		TIP32B	995
2SB521		TIP42A	1003	2SB673		BDW94C	205
2SB522		TIP42A	1003	2SB674		BDW94B	205
2SB523		2N5193	1077	2SB675		BDW94A	205
2SB524		2N5194	1077	2SB676		TIP127	1023
2SB526		MJE350	837	2SB677		TIP125	1023
2SB527		MJE350	837	2SB679		TIP117	1017
2SB528		MJE350	837	2SB681		BUW42	593
2SB529		2N5193	1077	2SB686		TIP36C	1001

* Datasheet available on request

CROSS REFERENCE

INDUSTRY STANDARD	SGS-THOMSON	SGS-THOMSON NEAREST	PAGE	INDUSTRY STANDARD	SGS-THOMSON	SGS-THOMSON NEAREST	PAGE
2SB689		TIP42C	1003	2SC681		BUW34	575
2SB690		TIP42C	1003	2SC758		BUW34	575
2SB693		2N6287	1149	2SC759		BUW34	575
2SB694		MJ11015	825	2SC760		BUW34	575
2SB696		BUW42	593	2SC768		2N3055	1039
2SB697		BUW42	593	2SC789		TIP31B	995
2SB707		2N6107	1140	2SC790		TIP31A	995
2SB708		2N6107	1140	2SC791		TIP31C	995
2SB711		2N6041	*	2SC793		BDW51C	193
2SB712		2N6042	1135	2SC794		BDW51C	193
2SB717		MJE350	837	2SC861		BUW25	*
2SB718		MJE350	837	2SC885		BU326	281
2SB722		BUW42	593	2SC886		BU326	281
2SB724		TIP32A	995	2SC887		BU326	281
2SB743		MJE170	829	2SC901		BU326	281
2SB744		MJE172	829	2SC901A		BU326	281
2SB750		TIP115	1017	2SC902		BU326	281
2SB751		BDX54B	217	2SC931		BD241A	155
2SB753		BD912	185	2SC932		BD241	155
2SB754		TIP36A	1001	2SC935		BUW34	575
2SB772		MJE170	829	2SC936		BU208	267
2SB833		MJ11013	825	2SC937		BU208	267
2SB834		TIP32A	995	2SC939		BU326	281
2SB855		TIP32A	995	2SC940		BU326	281
2SB856		TIP32A	995	2SC962		BDW51C	193
2SC407		BUX41	719	2SC999		BU208	267
2SC408		BUX41	719	2SC1004		BU208	267
2SC409		BUX41	719	2SC1004A		BU208	267
2SC410		BUX41	719	2SC1005		BU208	267
2SC411		BUX43	731	2SC1050		BU236	*
2SC412		BUX43	731	2SC1060		TIP31A	995
2SC431		BUX21	691	2SC1061		TIP31A	995
2SC432		BUX21	691	2SC1080		BDW51C	193
2SC433		BUX22	695	2SC1086		BU208	267
2SC434		BUX22	695	2SC1088		MJE3439	855
2SC495		2N4923	1063	2SC1089		MJE3439	855
2SC496		2N4921	1063	2SC1099		BU208	267
2SC558		BUW24	*	2SC1100		BU208	267
2SC646		2N3055	1039	2SC1101		BU208	267
2SC647		BDW51B	193	2SC1106		BU326	281
2SC664		BDW51C	193	2SC1107		BD243B	157
2SC675		BUW34	575	2SC1108		BS243C	157
2SC676		BUW34	575	2SC1109		BD243B	157
2SC677		BUW34	575	2SC1110		BD243C	157
2SC678		BUW34	575	2SC1114		BU326	281

* Datasheet available on request

CROSS REFERENCE

INDUSTRY STANDARD	SGS-THOMSON	SGS-THOMSON NEAREST	PAGE	INDUSTRY STANDARD	SGS-THOMSON	SGS-THOMSON NEAREST	PAGE
2SC1130		BU326	281	2SC1418		TIP31A	995
2SC1131		BU326	281	2SC1419		TIP31A	995
2SC1132		BU208	267	2SC1434		2N6546	*
2SC1133		BU208	267	2SC1440		BUW44	597
2SC1140		BUW45	597	2SC1441		BUW44	597
2SC1141		BUW45	597	2SC1447		TIP47	1005
2SC1142		BUW35	575	2SC1448		TIP47	1005
2SC1143		BUW35	575	2SC1449		MJE180	829
2SC1151		BU208	267	2SC1454		BU326	281
2SC1153		BU208	267	2SC1463		BU326	281
2SC1154		BU208	267	2SC1468		BUW34	999
2SC1162		MJE180	829	2SC1469		BUW34	999
2SC1167		BU208	267	2SC1477		BUW34	999
2SC1170		BU208	267	2SC1501		MJE3439	855
2SC1170A		BU208	267	2SC1505		TIP48	1005
2SC1171		BU208	267	2SC1506		TIP48	1005
2SC1172		BU208	267	2SC1507		TIP48	1005
2SC1173		TIP31	995	2SC1514		MJE3439	855
2SC1174		BU208	267	2SC1516		BD437	163
2SC1184		BU208	267	2SC1517		BD439	169
2SC1185		BU326	281	2SC1517A		BD441	169
2SC1212		BD235	149	2SC1565		MJE340	837
2SC1212A		BD237	149	2SC1576		BUW34	999
2SC1226		TIP31	995	2SC1577		BUW34	999
2SC1226A		TIP31A	995	2SC1578		BUW35	575
2SC1227		BUW34	999	2SC1579		BUW44	597
2SC1228		BUW34	999	2SC1580		BUW45	597
2SC1229		BUW34	999	2SC1584		BUX41	719
2SC1230		BUW34	999	2SC1585		BUX41	719
2SC1292		BU326	281	2SC1586		BUX42	727
2SC1295		BU208	267	2SC1617		BU326	281
2SC1308		BU208	267	2SC1618		BDW51B	193
2SC1309		BU208	267	2SC1619		BDW51C	193
2SC1325		BU208	267	2SC1625		TIP29C	*
2SC1348		BU208	267	2SC1626		TIP29B	*
2SC1358		BU208	267	2SC1667		BDW51C	193
2SC1367		BU208	267	2SC1669		TIP47	1005
2SC1368		MJE180	829	2SC1672		BUX11N	675
2SC1381		MJE182	829	2SC1683		TIP47	1005
2SC1382		MJE182	829	2SC1722		TIP48	1005
2SC1398		BD239B	153	2SC1723		TIP48	1005
2SC1409		TIP47	1005	2SC1749		MJE340	837
2SC1410		TIP47	1005	2SC1768		BU931R	337
2SC1413		BU208	267	2SC1777		2N3055	1039
2SC1413A		BU208	267	2SC1785		BUX41	719

* Datasheet available on request

CROSS REFERENCE

INDUSTRY STANDARD	SGS-THOMSON	SGS-THOMSON NEAREST	PAGE	INDUSTRY STANDARD	SGS-THOMSON	SGS-THOMSON NEAREST	PAGE
2SC1786		BUX42	727	2SC2248		2N6545	1163
2SC1818		BUX11N	675	2SC2256		BUX41	719
2SC1826		TIP41B	1003	2SC2260		BUX41	719
2SC1827		TIP41C	1003	2SC2261		BUX41	719
2SC1829		BU931R	337	2SC2262		BUX41	719
2SC1831		2N6056	*	2SC2278		MJE3439	855
2SC1832		BU932R	337	2SC2311		2N4922	1063
2SC1846		MJE180	829	2SC2323		BUW44	597
2SC1847		MJE181	829	2SC2324		2N6038	1131
2SC1848		BD241B	155	2SC2331		MJ13004	*
2SC1870		2N6546	*	2SC2333		MJE13005	859
2SC1875		BU208	267	2SC2344		TIP47	1005
2SC1880		TIP112	1017	2SC2373		MJE13006	863
2SC1881		TIP110	1017	2SC2397		MJE3055T	853
2SC1883		TIP122	1023	2SC2402		2N6546	*
2SC1891		BU208	267	2SC2428		BUX41	719
2SC1892		BU208	267	2SC2432		BDW51B	193
2SC1893		BU208	267	2SC2433		MJ11016	825
2SC1894		BU208	267	2SC4235		2N6059	1137
2SC1922		BU208	267	2SC4236		2N6059	1137
2SC1929		TIP48	1005	2SC2500		TIP31	995
2SC1942		BU208	267	2SC2516		2N6497	1159
2SC1983		TP111	1017	2SC2534		SGS13003	877
2SC1984		TIP112	1017	2SC2535		MJE13005	859
2SC1985		TIP41B	1003	2SC2552		MJE13005	859
2SC1986		TIP41C	1003	2SC2553		MJE13007	863
2SC2024		2N4923	1063	2SC2562		TIP41A	1003
2SC2027		BU208	267	2SC2612		SGDD00042	*
2SC2071		MJE3440	1043	2SC2613		SGSD00042	*
2SC2080		MJE180	829	2SC2815		SGSD00040	*
2SC2127		BUX41	719	2SC2816		SGSD00040	*
2SC2189		BUW34	575	2SD12		BDW51C	193
2SC2190		2N6545	1163	2SD15		BDW51C	193
2SC2191		2N6547	*	2SD16		BDW51C	193
2SC2209		MJE181	829	2SD26		BDW51C	193
2SC2229		TIP47	1005	2SD26A		BDW51C	193
2SC2230		TIP47	1005	2SD26B		BDW51C	193
2SC2233		2N6497	1159	2SD47		BDW51C	193
2SC2235		TIP47	1005	2SD50		BDW51C	193
2SC2236		TIP31	995	2SD51		BDW51C	193
2SC2238		TIP47	1005	2SD52		BDW51C	193
2SC2238A		TIP47	1005	2SD68		BDW51C	193
2SC2238B		TIP47	1005	2SD73		BDW51C	193
2SC2244		2N6545	1163	2SD80		BDW51C	193
2SC2246		2N6547	*	2SD81		BDW51C	193

* Datasheet available on request

CROSS REFERENCE

INDUSTRY STANDARD	SGS-THOMSON	SGS-THOMSON NEAREST	PAGE	INDUSTRY STANDARD	SGS-THOMSON	SGS-THOMSON NEAREST	PAGE
2SD88		BDW51C	193	2SD317		TIP31A	995
2SD107		MJ1001	815	2SD318		TIP31A	995
2SD108		MJ1001	815	2SD321		BUW34	575
2SD116		BDW51C	193	2SD325		TIP31	995
2SD119		BDW51C	193	2SD330		TIP31A	995
2SD124		BDW51C	193	2SD331		TIP31A	995
2SD124A		BDW51C	193	2SD335		BDW51C	193
2SD125		BDW51C	193	2SD338		BDW51B	193
2SD125A		BDW51C	193	2SD339		BDW51C	193
2SD131		BDW51C	193	2SD342		TIP31B	995
2SD163		2N3715	1047	2SD343		TIP31B	995
2SD168		BDX87B	233	2SD344		TIP31B	995
2SD172		2N5877	1115	2SD345		TIP31B	995
2SD174		2N5877	1115	2SD346		TIP41A	1003
2SD180		BDW51C	193	2SD347		TIP41A	1003
2SD181		BUW44	597	2SD348		BU208	267
2SD188		BDW51C	193	2SD351		2N6545	1163
2SD189		BDW51B	193	2SD356		2N4923	1063
2SD189A		BDW51C	193	2SD357		2N4923	1063
2SD201		BDW51C	193	2SD358		2N4923	1063
2SD206		2N5877	1115	2SD359		2N5190	1077
2SD211		2N5877	1115	2SD360		2N5190	1077
2SD231		2N5302	1083	2SD361		2N5191	1077
2SD232		BUV20	433	2SD365		TIP31A	995
2SD234		TIP31A	995	2SD366A		TIP31B	995
2SD235		TIP31A	995	2SD368		BU208	267
2SD246		BU208	267	2SD369		2N3716	1047
2SD247		BUW51B	*	2SD371		BDW51C	193
2SD249		2N5302	1083	2SD375		BUX41	719
2SD260		BDW51C	193	2SD376		BUX42	727
2SD262		2N6546	*	2SD377		BUV24	437
2SD265		2N6545	1163	2SD379		BDW51	193
2SD266		2N6545	1163	2SD380		BU208	267
2SD273		2N6545	1163	2SD386		MJE13004	859
2SD274		2N6545	1163	2SD387		MJE13004	859
2SD288		TIP31B	995	2SD389		TIP31A	995
2SD288		TIP31B	995	2SD390		TIP31A	995
2SD289		TIP31B	995	2SD396		2N6547	*
2SD293		2N6547	*	2SD401		TIP47	1005
2SD294		2N6547	*	2SD402		TIP47	1005
2SD301		BDX87B	233	2SD417		BUW34	575
2SD310		2N6547	*	2SD429		2N6547	*
2SD311		2N6547	*	2SD434		BUX41	719
2SD313		TIP31A	995	2SD435		BUV23	437
2SD314		TIP31A	995	2SD436		BUV24	437

* Datasheet available on request

CROSS REFERENCE

INDUSTRY STANDARD	SGS-THOMSON	SGS-THOMSON NEAREST	PAGE	INDUSTRY STANDARD	SGS-THOMSON	SGS-THOMSON NEAREST	PAGE
2SD439		2N4921	1063	2SD600		2N492	1063
2SD459		TIP121	1023	2SD604		BU920	329
2SD460		TIP122	1023	2SD605		BU920	329
2SD463		2N6056	*	2SD608		TIP47	1005
2SD464		2N6056	*	2SD610		TIP47	1005
2SD473		MJ11016	825	2SD612		MJE520	841
2SD475		2N6122	1143	2SD613		TIP41C	1003
2SD476		2N6123	1143	2SD626		BU931R	337
2SD478		TIP47	1005	2SD628		BDX87C	233
2SD479		2N6037	1131	2SD629		BDX87C	233
2SD480		2N6038	1131	2SD630		2N5302	1083
2SD481		2N6039	1131	2SD631		2N5302	1083
2SD482		2N5655	1103	2SD633		BDW93C	205
2SD483		2N5656	1103	2SD634		BDW93B	205
2SD484		2N5657	1103	2SD635		BDW93A	205
2SD485		2N5190	1077	2SD640		2N6545	1163
2SD486		2N5191	1077	2SD650		BU920	329
2SD487		2N5192	1077	2SD663		BU920	329
2SD488		2N4921	1063	2SD665		BUX41	719
2SD489		2N4922	1063	2SD668		MJE340	837
2SD490		2N4923	1063	2SD668A		MJE340	837
2SD491		MJE3055T	853	2SD670		MJ11016	825
2SD492		2N3055	1039	2SD678		TIP110	1017
2SD493		2N5877	1115	2SD679		TIP111	1017
2SD494		2N5878	1115	2SD683		BUT13	385
2SD495		BDW51C	193	2SD685		BU932R	337
2SD499		MJE3055T	853	2SD686		TIP122	1023
2SD500		MJE3055T	853	2SD687		TIP121	1023
2SD502		2N6055	1139	2SD689		TIP112	1017
2SD503		2N6056	*	2SD692		2N6056	*
2SD504		2N6057	1137	2SD693		BU931R	337
2SD505		2N6058	1137	2SD705		BU931R	337
2SD506		2N6059	1137	2SD709		BU920	329
2SD523		2N6055	1139	2SD710		MJ10004	823
2SD524		MJ11014	825	2SD716		TIP35C	1001
2SD525		TIP41C	1003	2SD717		D44H10	803
2SD526		TIP41B	1003	2SD721		2N6045	1135
2SD531		TIP41C	1003	2SD722		2N6045	1135
2SD544		TIP41C	1003	2SD723		TIP31C	995
2SD552		BUX42	727	2SD724		MJE13004	859
2SD553		TIP41B	1003	2SD725		BU208A	267
2SD570		BD241B	155	2SD726		TIP31C	995
2SD574		MJ11016	825	2SD729		2N6284	1149
2SD575		BU208	267	2SD730		MJ11016	825
2SD597		BDW51C	193	2SD731		BUW44	597

* Datasheet available on request

INDUSTRY STANDARD	SGS-THOMSON	SGS-THOMSON NEAREST	PAGE	INDUSTRY STANDARD	SGS-THOMSON	SGS-THOMSON NEAREST	PAGE
2SD732		BUW44	597	2SD956		BU208D	271
2SD733		BUW44	597	2SD957A		BU208D	271
2SD753		BUW41	*	2SD978		BU920T	329
2SD757		MJE3440	855	2SD979		BU920T	329
2SD758		MJE3440	855	2SD990		TIP112	1017
2SD759		TIP47	1005	2SD993		BU208D	271
2SD760		TIP47	1005	2SD994		BU208D	271
2SD761		TIP47	1005	2SD1061		D44H8	803
2SD762		TIP31A	995	2SD1062		D44H8	803
2SD764		BU208	267	2SD1069		BU407D	291
2SD783		BU208	267	2SD1131		D44H8	863
2SD793		MJE180	829	2SD1132		D44H8	803
2SD794		MJE182	829	2SD1163		BU406	285
2SD801		2N6545	1163	2SD1163A		BU406	285
2SD802		2N6545	1163	2SD1201		BU932R	337
2SD811		2N6545	1163	2SD1203		BU930Z	*
2SD818		BU208	267				
2SD819		BU208	267				
2SD820		BU208A	267				
2SD821		BU208A	267				
2SD823		BU408	285				
2SD836		TIP110	1017				
2SD837		TIP120	1023				
2SD839		BDX53A	217				
2SD840		BDX53B	217				
2SD843		BD911	185				
2SD844		TIP35A	995				
2SD868		BU208D	271				
2SD869		BU208D	271				
2SD870		BU208D	271				
2SD878		2N3055	1039				
2SD880		TIP31A	995				
2SD882		MJE180	829				
2SD897		BU208D	271				
2SD897A		BU208D	271				
2SD898		BU208D	271				
2SD898A		BU208D	271				
2SD898B		BU208D	271				
2SD899		BU208D	271				
2SD899A		BU208D	271				
2SD900		BU208D	271				
2SD900A		BU208D	271				
2SD900B		BU208D	271				
2SD903		BU208D	271				
2SD904		BU208D	271				

* Datasheet available on request

ALPHABETICAL LIST OF SYMBOLS

B	Bandwidth
C_{CB0}	Collector-base capacitance (emitter open to a.c. and d.c.)
d	Distortion
$E_{s/b}$	Second breakdown energy (with base-emitter junction reverse biased)
f	Frequency
f_T	Transition frequency
G_v	Voltage gain
h_{fe}	Common emitter, small-signal value of the short-circuit forward current transfer ratio
h_{FE}	Common emitter, static value of the forward current transfer ratio
h_{FE1}/h_{FE2}	Common emitter, static value of the forward current transfer matched pair ratio
I_B	Base current
I_{B1}	Turn-on current
I_{B2}	Turn-off current
I_{BF}	Base forward current
I_{BFM}	Base forward peak current
I_{BM}	Base peak current
I_{BR}	Base reverse current
I_{BRM}	Base reverse peak current
I_C	Collector current
I_{CBO}	Collector cut-off current with emitter open
I_{CEO}	Collector cut-off current with base open
I_{CER}	Collector cut-off current with specified resistance between emitter and base
I_{CES}	Collector cut-off current with emitter short-circuited to base
I_{CEV}	Collector cut-off current with specified reverse voltage between emitter and base
I_{CEX}	Collector cut-off current with specified circuit between emitter and base
I_{CM}	Collector peak current
I_{CRMS}	RMS collector current
I_d	Drain current
I_E	Emitter current
I_{EBO}	Emitter cut-off current with collector open
I_F	Continuous DC forward current
I_{FM}	Peak forward current
I_R	Continuous DC reverse current
I_{RM}	Peak reverse current
I_{RSM}	Surge non-repetitive reverse current
$I_{s/b}$	Second breakdown collector current (with base-emitter junction forward biased)
P_o	Output power of a specified circuit
P_{tot}	Total power dissipation
R_{BB}	Base dropping resistance
R_{BE}	Resistance between base and emitter
R_{CC}	Collector dropping resistance
R_{EE}	Emitter dropping resistance
R_L	Load resistance
r_s	Series resistance
R_{th}	Thermal resistance
$R_{th j-amb}$	Thermal resistance junction-to-ambient
$R_{th j-case}$	Thermal resistance junction-to-case
T_{amb}	Ambient temperature
T_{case}	Case temperature
T_j	Junction temperature
T_{stg}	Storage temperature
t	Time
t_c	Crossover time
t_d	Delay time
t_f	Fall time

t_{off}	Turn-off time
t_{on}	Turn-on time
t_p	Pulse width
t_r	Rise time
t_{rr}	Reverse recovery time of a diode
t_s	Storage time
V_{BE}	Base-emitter voltage
$V_{BE(sat)}$	Base-emitter saturation voltage
$V_{(BR)CBO}$	Collector-base breakdown voltage with emitter open
$V_{(BR)CEO}$	Collector-emitter breakdown voltage with base open
$V_{(BR)CER}$	Collector-emitter breakdown voltage with specified resistance
$V_{(BR)CES}$	Collector-emitter breakdown voltage with emitter short-circuited to base
$V_{(BR)CEV}$	Collector-emitter breakdown voltage with specified reverse voltage between emitter and base, $r_s = 0$
$V_{(BR)CEX}$	Collector-emitter breakdown voltage with specified circuit between emitter and base
$V_{(BR)EBO}$	Emitter-base breakdown voltage with collector open
V_{CB}	Collector-base voltage
V_{CBO}	Collector-base voltage with emitter open
V_{CC}	Collector DC voltage supply
V_{CE}	Collector-emitter voltage
V_{CEK}	Knee voltage at specified condition
V_{CEO}	Collector-emitter voltage with base open
$V_{CEO(sus)}$	Collector-emitter sustaining voltage with base open
V_{CER}	Collector-emitter voltage with specified resistance between emitter and base
$V_{CER(sus)}$	Collector-emitter sustaining voltage with specified resistance between emitter and base
$V_{CE(sat)}$	Collector-emitter saturation voltage
V_{CES}	Collector-emitter voltage with emitter short-circuited to base
V_{CEV}	Collector-emitter voltage with specified reverse voltage between emitter and base
$V_{CEV(sus)}$	Collector-emitter sustaining voltage with specified reverse voltage between emitter and base
V_{CEW}	Maximum collector-emitter voltage at turn-off with a specified current without snubber
$V_{CEX(sus)}$	Collector-emitter sustaining voltage with specified circuit between emitter and base
V_{EB}	Emitter-base voltage
V_{EBO}	Emitter-base voltage with collector open
V_F	Continuous DC forward voltage
V_{FM}	Forward transient voltage
V_I	Input voltage of a specified circuit
V_R	Continuous DC reverse voltage
V_{RM}	Peak reverse voltage
V_{RRM}	Repetitive peak reverse voltage
Z_{BE}	Impedance between base and emitter
Z_I	Input impedance
ΔT	Temperature variation
δ	Duty cycle
ω	Angular frequency

A. DEFINITIONS OF TERMS USED

- a. Electronic device.** An electronic tube or valve, transistor or other semiconductor device. Note: This definition excludes inductors, capacitors, resistors and similar components.
- b. Characteristic.** A characteristic is an inherent and measurable property of a device. Such a property may be electrical, mechanical, thermal, hydraulic, electro-magnetic, or nuclear and can be expressed as a value for stated or recognized conditions. A characteristic may also be a set of related values, usually shown in graphical form.
- c. Bogey electronic device.** An electronic device whose characteristics have the published nominal values for the type. A bogey electronic device for any particular application can be obtained by considering only those characteristics which are directly related to the application.
- d. Rating.** A value which establishes either a limiting capability or a limiting condition for an electronic device. It is determinate for specified values of environment and operation, and may be stated in any suitable terms.
Note: Limiting conditions may be either maxima or minima.
- e. Rating system.** The set of principles upon which ratings are established and which determines their interpretation.
Note: The rating system indicates the division of responsibility between the device manufacturer and the circuit designer, with the object of ensuring that the working conditions do not exceed the ratings.

B. ABSOLUTE MAXIMUM RATING SYSTEM

Absolute maximum ratings are limiting values of operating and environmental conditions applicable to any electronic device of a specified type as defined by its published data, which should not be exceeded under the worst probable conditions.

These values are chosen by the device manufacturer to provide acceptable serviceability of the device, taking no responsibility for equipment variations, environmental variations, and the effects of changes in operating conditions due to variations in the characteristics of the device under consideration and of all other electronic devices in the equipment. The equipment manufacturer should design so that, initially and throughout life, no absolute maximum value for the intended service is exceeded with any device under the worst probable operating condi-

tions with respect to supply voltage variation, equipment component variation, equipment control adjustment, load variations, signal variation, environmental conditions, and variation in characteristics of the device under consideration and of all other electronic devices in the equipment.

C. DESIGN - MAXIMUM RATING SYSTEM

Design-maximum ratings are limiting values of operating and environmental conditions applicable to a bogey electronic device of a specified type as defined by its published data, and should not be exceeded under the worst probable conditions.

These values are chosen by the device manufacturer to provide acceptable serviceability of the device, taking responsibility for the effects of changes in operating conditions due to variations in the characteristics of the electronic device under consideration.

The equipment manufacturer should design so that, initially and throughout life, no design-maximum value for the intended service is exceeded with a bogey device under the worst probable operating conditions with respect to supply-voltage variation equipment, component variation, variation in characteristics of all other devices in the equipment, equipment control adjustment, load variation, signal variation and environmental conditions.

D. DESIGN - CENTRE RATING SYSTEM

Design-centre ratings are limiting values of operating and environmental conditions applicable to a bogey electronic device of a specified type as defined by its published data, and should not be exceeded under normal conditions.

These values are chosen by the device manufacturer to provide acceptable serviceability of the device in average applications, taking responsibility for normal changes in operating conditions due to rated supply-voltage variation, equipment component variation, equipment control adjustment, load variation, signal variation, environmental conditions, and variations in the characteristics of all electronic devices.

The equipment manufacturer should design so that, initially, no design-centre value for the intended service is exceeded with a bogey electronic device in equipment operating at the stated normal supply-voltage.

The Absolute Maximum Rating System is commonly used for semiconductor devices.

PRECAUTIONS FOR PHYSICAL HANDLING OF POWER PLASTIC TRANSISTOR [TO-220, ISOWATT220, TO-218 (SOT-93), ISOWATT218, TO-126 (SOT-32), SOT-82, SOT-194]

When mounting power transistors certain precautions must be taken in operations such as bending of leads, mounting of heatsink, soldering and removal of flux residue. If these operations are not carried out correctly, the device can be damaged or reliability compromised.

1. Bending and cutting leads

The bending or cutting of the leads requires the following precautions:

- 1.1. When bending the leads they must be clamped tightly between the package and the bending point to avoid strain on the package (in particular in the area where the leads enter the resin) (fig. 1). This also applies to cutting the leads (fig. 2).
- 1.2. The leads must be bent at a minimum distance of 3 mm from the package (fig. 3a).

Figure 1 - Bending the Leads

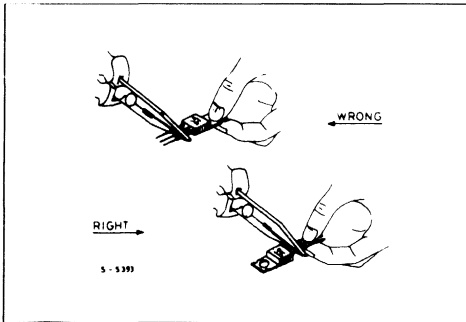
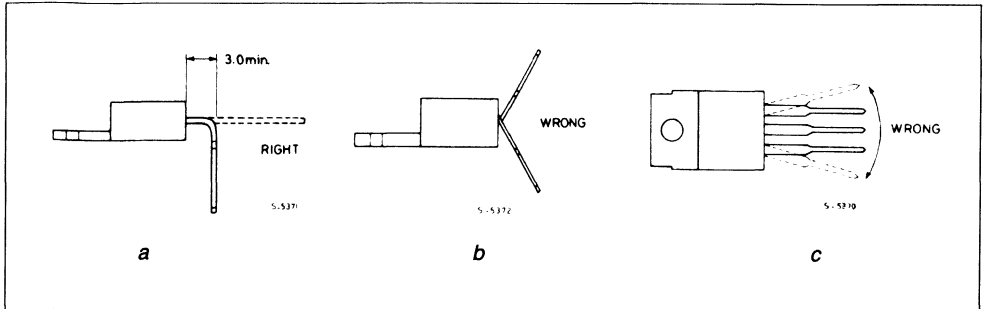

Figure 3 - Angles for Lead Wire Bending



- 1.3. The leads should not be bent at an angle of more than 90° and they must be bent only once (fig. 3b).
- 1.4. The leads must never be bent laterally (fig. 3c).
- 1.5. Check that the tool used to cut or form the leads does not damage them or ruin their surface finish.

2. Mounting on printed circuit

During mounting operations be careful not to apply stress to the power transistor.

- 2.1. Adhere strictly to the pin spacing of the transistor to avoid forcing the leads.
- 2.2. Leave a suitable space between printed circuit and transistor, if necessary use a spacer.
- 2.3. When fixing the device to the printed circuit do not put mechanical stress on the transistor. For this purpose the device should be soldered to the printed circuit board after the transistor has been fixed to the heatsink and the heatsink to the printed circuit board.

Figure 2 - Lead Forming or Cutting Mechanism

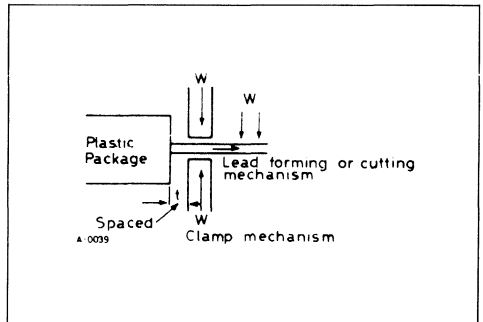

3. Soldering

In general a transistor should never be exposed to high temperature for any length of time. It is therefore preferable to use soldering methods where the transistor is exposed to the lowest possible temperatures for a short time.

- 3.1. Tolerable conditions are 260°C for 10 sec or 350° for 3 sec. The graphs in fig. 4 give an idea of the excess junction temperature during the soldering process for a TO-220 (Ver-

sawatt). It is also important to use suitable fixes for the tin baths to avoid deterioration of the leads or of the package resin.

- 3.2. An excess of residual flux between the pins of the transistor or in contact with the resin can reduce the long-term reliability of the device. The solvent for removing excess flux must be chosen with care. The use of solvents derived from trichloroethylene is not recommended on plastic packages because the residue can cause corrosion.

Figure 4 - Junction Temperatures During Soldering

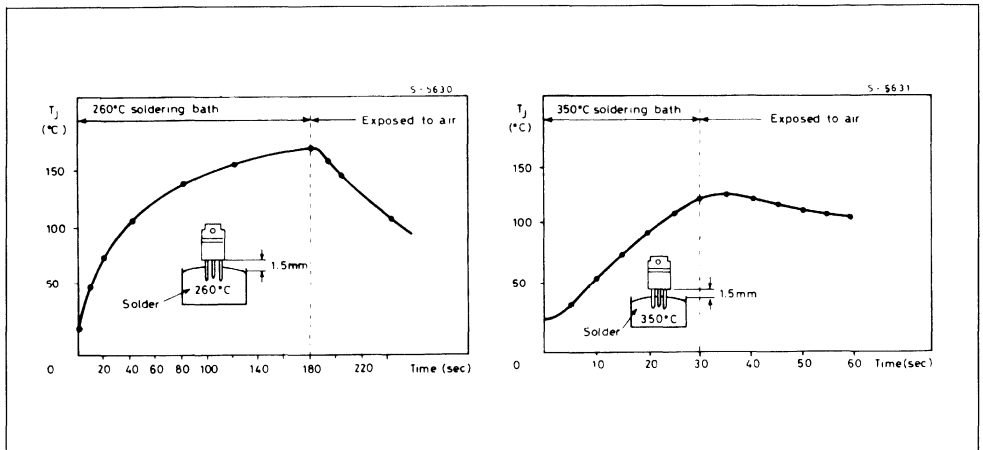

4. Mounting at heatsink

To exploit best the performance of power transistor a heatsink with R_{th} suitable for the power that the transistor will dissipate must be used.

- 4.1. The plastic packages used by SGS-THOMSON for its power transistor (SOT-32, SOT-82, SOT-194, TO-220, ISOWATT220, TO-218, ISOWATT218) provide for the use of a single screw to fix the package to the heat-sink. A compression spring (clip) can be sufficient as an alternative (fig. 5).

The screw should be properly tightened to en-

sure good contact between the back of the package and the heatsink but should not be too tight to avoid deformation of the copper part (tab) of the package causing breaking of the die or separation of the resin from the tab.

- 4.2. The contact R_{th} between device and heat-sink can be improved by inserting a thin layer of silicone grease with fluidity sufficient to guarantee perfectly uniform distribution on the surface of the tab. The thermal resistance with and without silicone grease is given in fig. 6. An excessively thick layer or an excessive viscosity of the grease can degrade the R_{th} .

Figure 5 - SOT-93 mounting examples

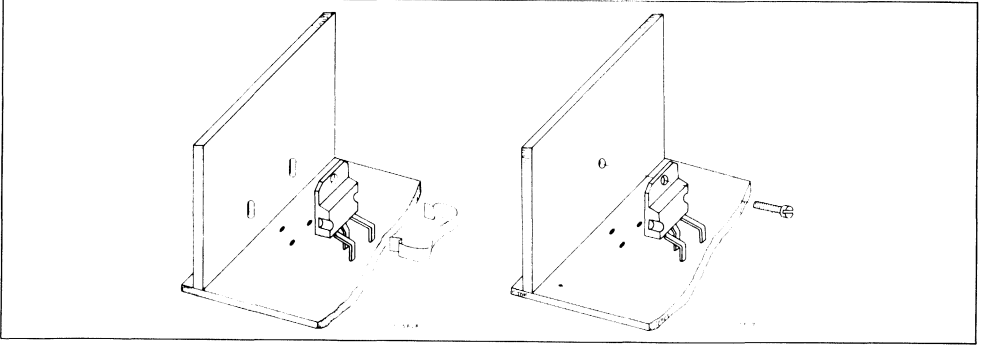
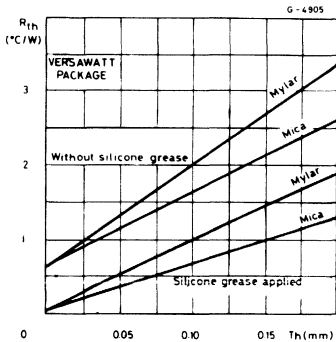

Figure 6 - Contact thermal resistance vs. insulator thickness.



5. Heatsink problems

The most important aspect from the point of view of reliability of a power transistor is that the heatsink should be dimensioned to keep the T_j of the device as low as possible. From the mechanical point of view, however, the heatsink must be realized so that it does not damage the device.

- 5.1. The planarity of the contact surface between device and heatsink must be $< 25\mu\text{m}$ for TO-220, ISOWATT220, TO-218, ISOWATT218, TO-126 (SOT-32), SOT-82, SOT-194.

Figure 7 - Device Mounting

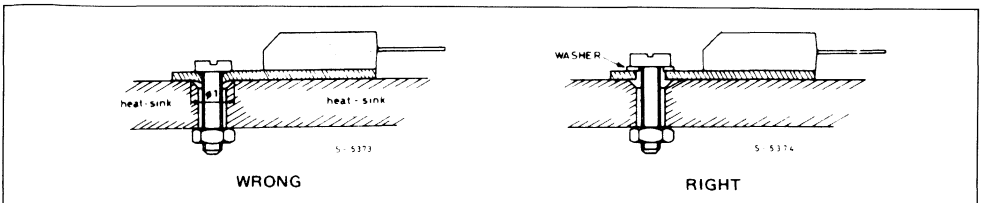

- 5.2. If self threading screws are used there must be an outlet for the material that is deformed during formation of the thread. The diameter $\varnothing 1$ (fig. 7) must be large enough to avoid distortion of the tab during tightening. For this purpose it may be useful to insert a washer or use of the type shown in fig. 8 where the pressure on the tab is distributed on a much larger surface. Sometimes when the hole in the heatsink is formed with a punch, around the hole or hollow there may be a ring which is lower than the heatsink surface. This is dangerous because it may lead to distortion of the tab as mentioned before.
- 5.3. A very serious problem is that of the rigidity between heatsink, device and printed circuit board. Once the device and the heatsink are mechanically connected, and the heatsink is fixed to the apparatus frame, the device and the PCB are bound together by the leads of the devices. A solution of this type is extremely dangerous.

Figure 8 - Suggested Screw

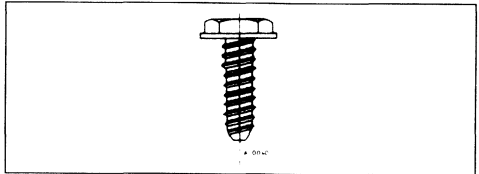

TO-3

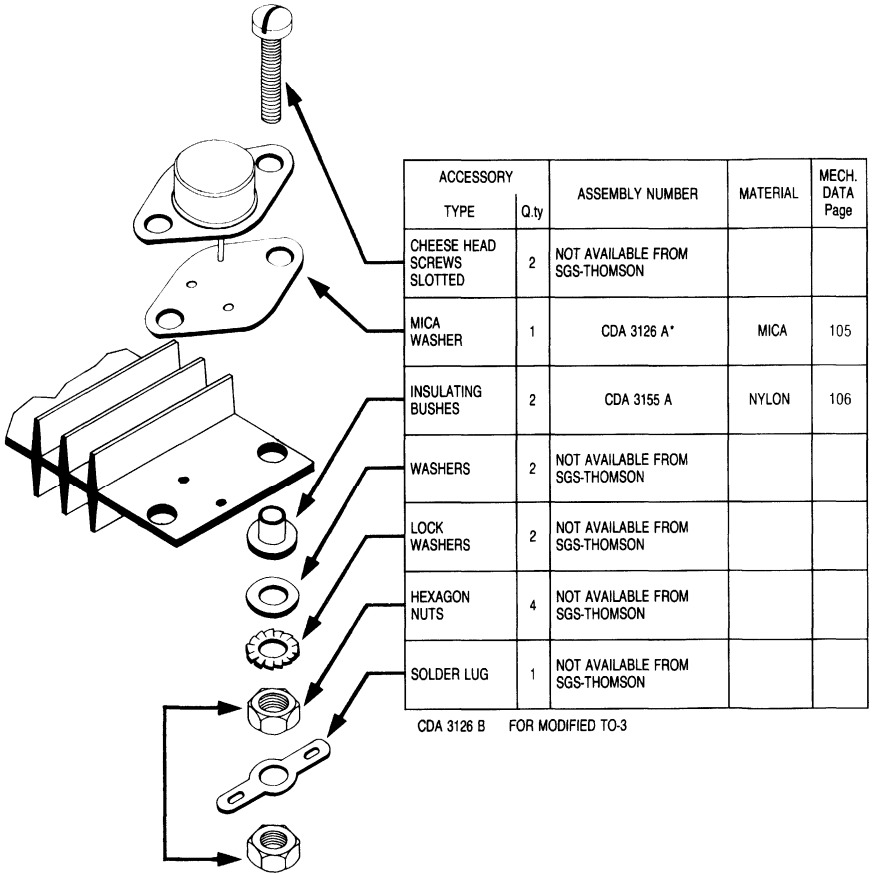

Maximum torque (applied to mounting flange)
 Recommended: 0.55 Nm
 Maximum: 1 Nm.

TO-218 (SOT-93)

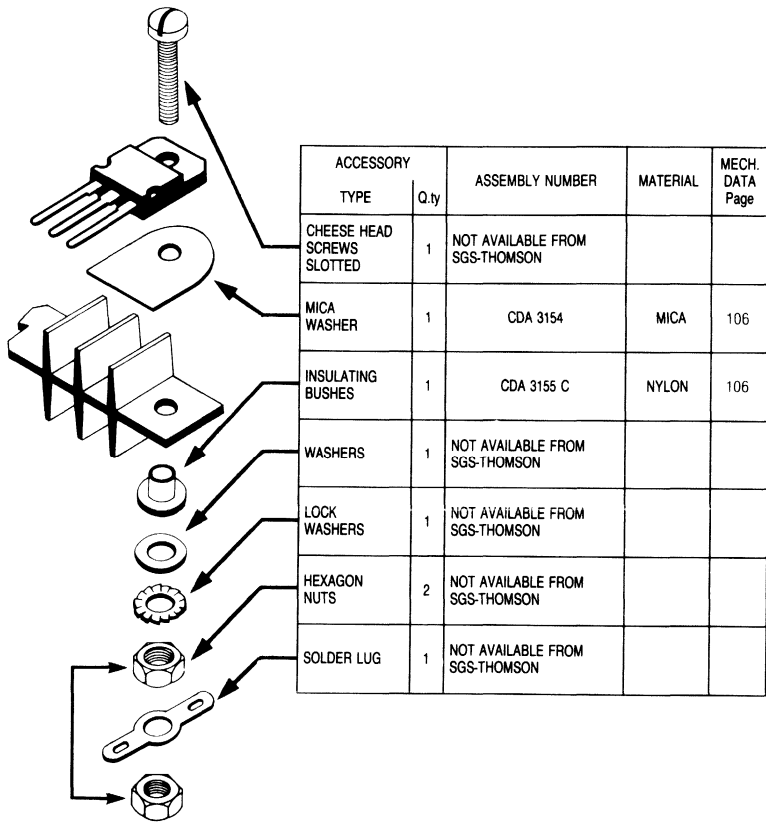

Maximum torque (applied to mounting flange)
 Recommended: 0.55 Nm
 Maximum: 1 Nm.

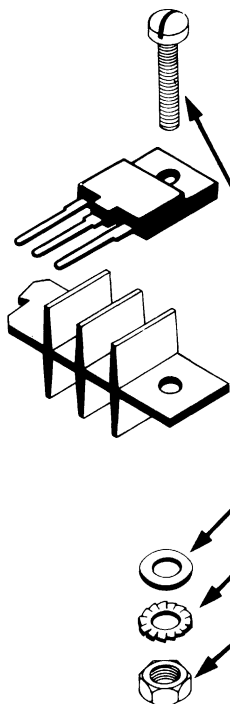

ACCESSORY TYPE	Q.ty	ASSEMBLY NUMBER	MATERIAL	MECH. DATA Page
CHEESE HEAD SCREWS SLOTTED	1	NOT AVAILABLE FROM SGS-THOMSON		
WASHERS	1	NOT AVAILABLE FROM SGS-THOMSON		
LOCK WASHERS	1	NOT AVAILABLE FROM SGS-THOMSON		
HEXAGON NUTS	1	NOT AVAILABLE FROM SGS-THOMSON		

Maximum torque (applied to mounting flange)
 Recommended: 0.55 Nm
 Maximum: 1 Nm.

TO-220

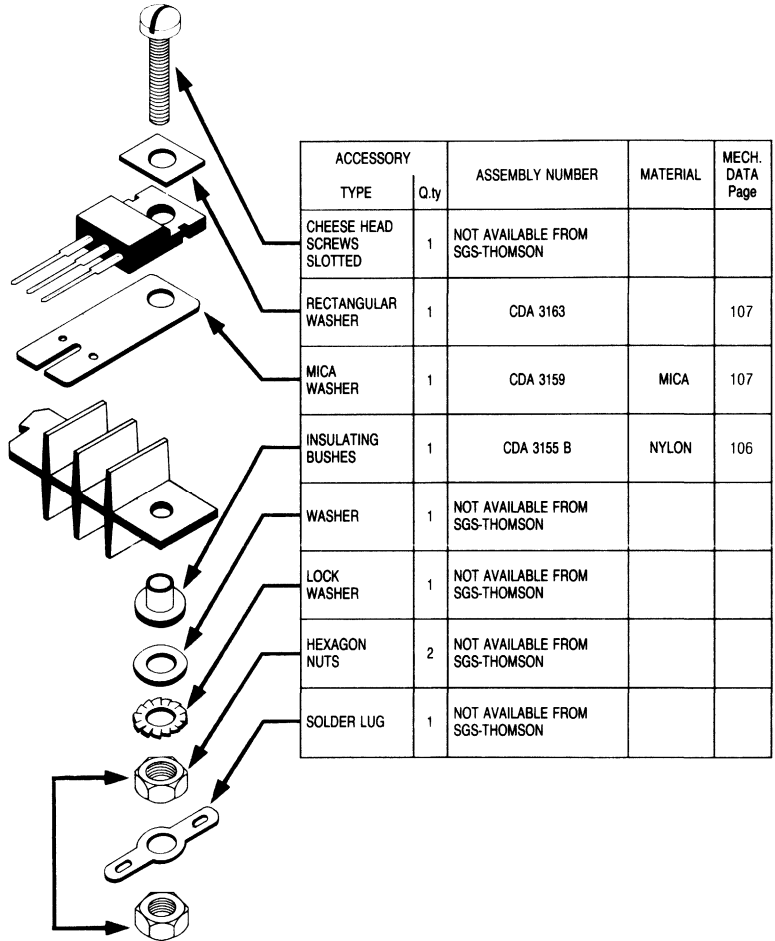

Maximum torque (applied to mounting flange)
 Recommended: 0.55 Nm
 Maximum: 0.7 Nm.

TO-220

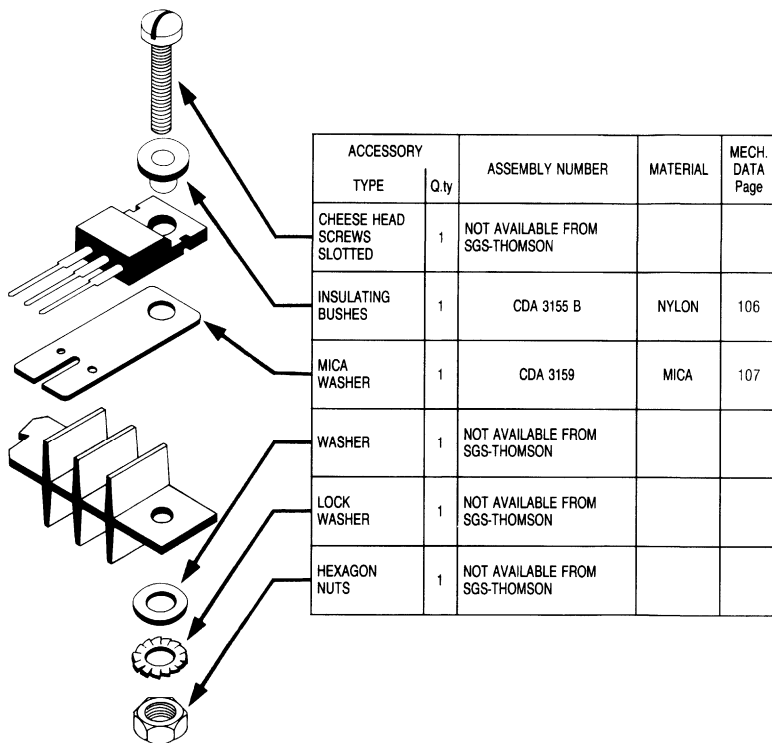

Maximum torque (applied to mounting flange)

Recommended: 0.55 Nm

Maximum: 0.7 Nm.

ISOWATT220

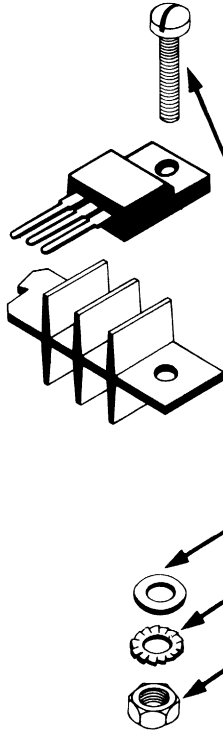

ACCESSORY		ASSEMBLY NUMBER	MATERIAL	MECH. DATA Page
TYPE	Q.ty			
CHEESE HEAD SCREWS SLOTTED	1	NOT AVAILABLE FROM SGS-THOMSON		
WASHER	1	NOT AVAILABLE FROM SGS-THOMSON		
LOCK WASHER	1	NOT AVAILABLE FROM SGS-THOMSON		
HEXAGON NUTS	1	NOT AVAILABLE FROM SGS-THOMSON		

Maximum torque (applied to mounting flange)
 Recommended: 0.55 Nm
 Maximum: 0.7 Nm.

TO-126, SOT-82, SOT-194, TO-220, TO-218

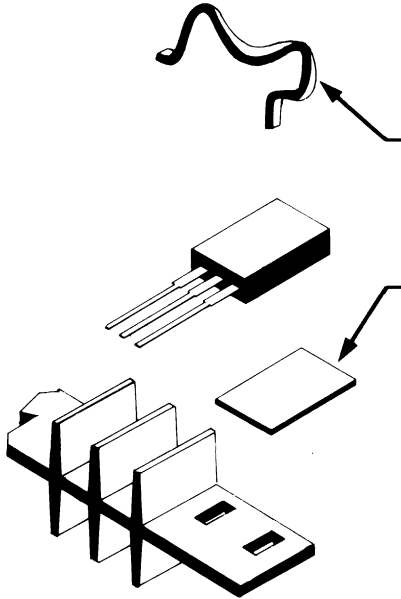

ACCESSORY		ASSEMBLY NUMBER	MATERIAL	MECH. DATA Page
TYPE	Q.ty			
SPRING CLIP	1	NOT AVAILABLE FROM SGS-THOMSON		
MICA WASHER	1	TO-126 } NOT AVAILABLE FROM SOT-82 } FROM SOT-194 } SGS-THOMSON TO-220: CDA3159 TO-218: CDA3154	MICA	107 106

ISOWATT220, ISOWATT218, TOP-3I

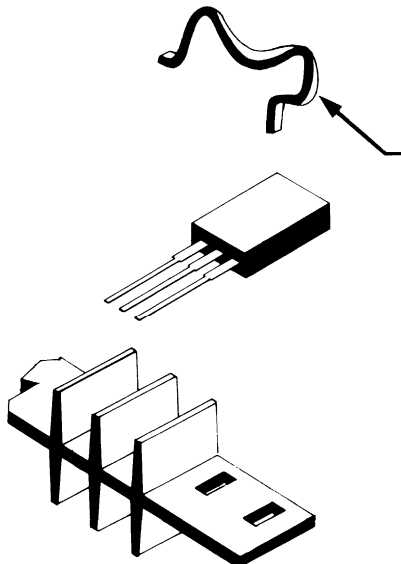

ACCESSORY		ASSEMBLY NUMBER	MATERIAL	MECH. DATA Page
TYPE	Q.ty			
SPRING CLIP	1	NOT AVAILABLE FROM SGS-THOMSON		

CDA 3126A

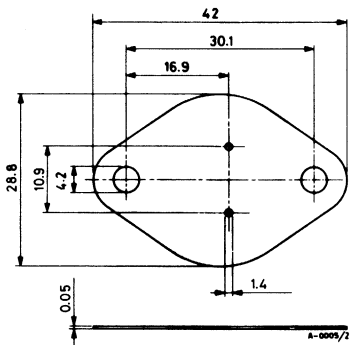

CDA 3126B

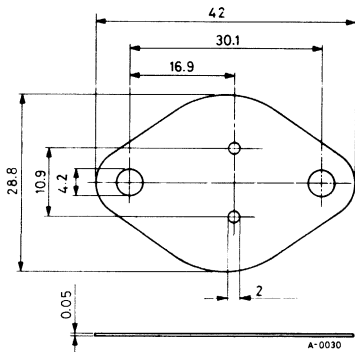

CDA 3154

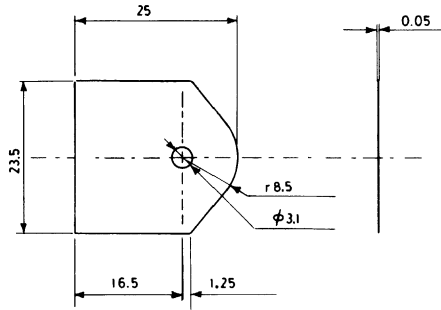

A-0042

CDA 3155

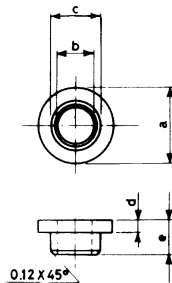

A - 0024/2

Suffix	Package	a	b	c	d	e
A	TO-3	6.40 to 6.60	3.00 to 3.10	4.00 to 4.05	1.1 max	1.55 to 1.65
B	TO-220	5.30 to 5.50	3.00 to 3.10	3.83 to 3.88	0.60 to 0.65	1.70 to 1.80
C	SOT-93	6.40 to 6.60	3.00 to 3.10	4.00 to 4.05	1.3 to 1.4	2.7 to 2.9

Material: Nylon

Dimensions: mm

CDA 3159

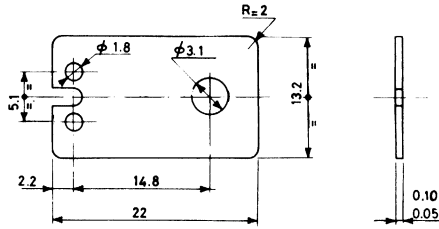

A-0026/3

TYPE	MATERIAL	NOTE
CDA3159	MICA	

CDA 3163

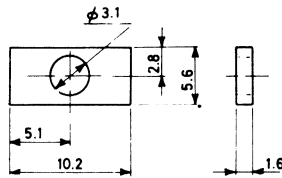

A-0023/3

TYPE	MATERIAL	NOTE
CDA3163	Steel nickel plated	

ISOWATT218 AND ISOWATT220 EASY TO USE ISOLATED POWER PACKAGES

General

SGS-THOMSON has developed two isolated packages, the ISOWATT218 and the ISOWATT220 for use in place of the standard SOT-93/TO-218 and TO-220 respectively. These packages have been designed to be produced with high volume automated equipment. They are easy to mount and fully isolated which reduces overall costs and improves

reliability compared with conventional packages. The isolation of the collector from the heatsink is achieved by molding the package with a high thermal conductivity epoxy resin. The thickness of the resin is closely controlled over the back surface of the internal copper heat spreader.

Figure 1a: The ISOWATT218 Construction.

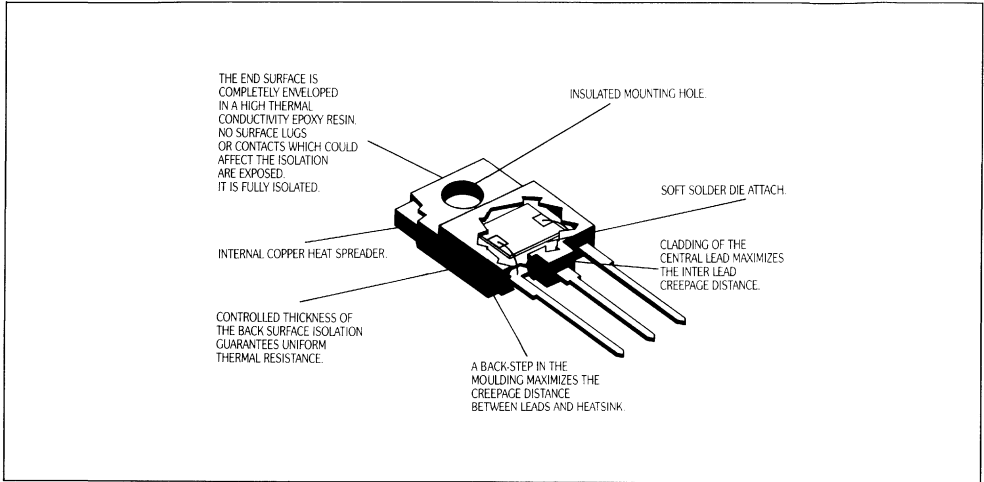
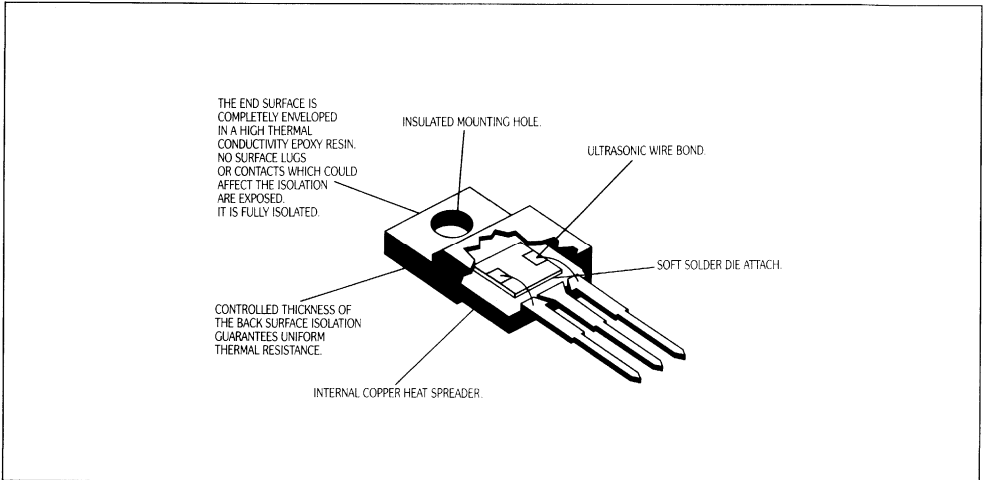

Figure 1b: The ISOWATT220 Construction.



INSULATION CHARACTERISTICS

	ISOWATT218	ISOWATT220
Insulation voltage between connection and heat sink	≥ 2500V AC for 1 minute ≥ 4000V DC for 1 second	≥ 1500V AC for 1 minute ≥ 2000V DC for 1 second
Creepage distance over the surface	≥ 4 mm	≥ 2.28 mm
Clearance distance	≥ 3 mm	≥ 2.28 mm

THERMAL RESISTANCE OF STANDARD AND ISOWATT PACKAGES

The evaluation of thermal resistance is difficult for the equipment designer as no easy method of measurement is available. This task is made more difficult as power semiconductor suppliers publish thermal resistance data for the junction to case which in most practical situations becomes small compared with the total impedance from junction to ambient.

Considering applications where the popular medium power plastic encapsulated devices will be used, with small to medium size heatsinks, the thermal resistance from the package case to the heatsinks via any intermediate isolation becomes an important consideration. In the majority of applications of high voltage devices in off-line switching power supplies, CRT deflection or motor controls, some form of isolation must be employed which can vary from 800V DC up to 2500V AC (3500V DC) depending on the application environment and safety regulations which must be met.

Examining this subject using various power semiconductor suppliers recommendations only adds some confusion which appears to be due to variations in test conditions and mounting torques which are not clearly specified. It should be added that the difficult nature of R_{th} measurement can easily cause a 10% uncertainty in the results.

The ISOWATT218 and ISOWATT220 offer many advantages over the conventional SOT-93/TO-218 and TO-220 packages when isolation from the heat-sink is required. However the question is how does their thermal resistance compare in different conditions of mounting? The following notes and evaluations were made to try to offer an understanding of this together with some practical advice.

MAXIMUM POWER DISSIPATION

In equipment, the maximum power dissipation of a transistor is limited by the thermal resistance junction-heatsink plus thermal resistance heatsink - ambient and not only by the thermal resistance junction - case.

$$P_{Dmax} = T_{jmax} / R_{th\ j-hs} + R_{th\ hs-a}$$

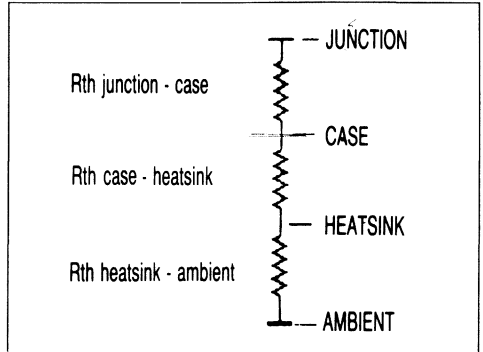

Thermal resistance case to heatsink

The very best which can be achieved with direct mounting is about 0.5°C/W with thermal grease and clip mounting. (If no thermal grease is used, this value will range about 1.4°C/W).

When an isolation layer is used between the package and heatsink the thermal resistance will depend on the desired insulation properties and may vary by about 2°C/W.

This is summarized by the following figure:

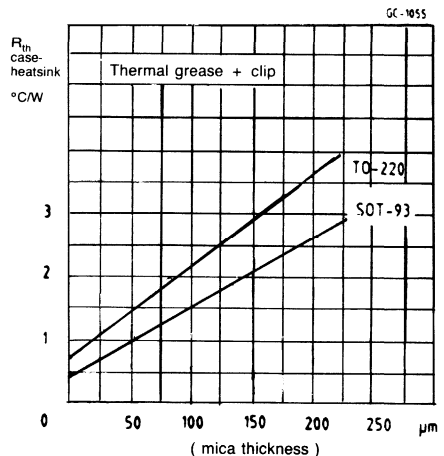

MAXIMUM POWER DISSIPATION (Cont'd)

For the conventional package, thermal compound is applied both sides of the isolation washer for the best heat transfer. Mounting with a screw, the thermal resistance may vary by about 0.3°C/W for torque variations - higher torque than 0.8 - 1.0Nm (≈ 8 - 10kg * cm) are not recommended with insulating washers due to the risk of damaging them. If a clip is used over the centre of the package a limited force is necessary for spring clips which can easily be assembled.

For the ISOWATT218 and ISOWATT220 package, mounted with thermal grease, the effect of torque or clip force is less noticeable as there is only one layer of compound to compress. Also there is no fragile isolation washer so the torque or the clip force are less critical. Also the temperature gradient between the case and heatsink is very low and the thermal resistance between the case and heatsink lies between 0.1 to 0.2 °C/W.

RESULTING THERMAL RESISTANCE JUNCTION - HEATSINK.

The tables 1A and 1B give an idea of the various possibilities.

COST COMPARISON

The ISOWATT218 and ISOWATT220 packages save both time and the cost of accessories for mounting.

The cost savings are:

1. Direct cost of materials
2. Cost of ordering, storing and issuing the materials to the assembly department
3. The time taken to mount these materials.

Productivity of mounting a conventional plastic power transistor on a heatsink with isolating bush, isolating washer and screw is estimated at 0.02 hours. For TO-3 style packages the figure will be much longer, while with the ISOWATT218 or ISOWATT220 the productivity should be increased by about 50%. Using a clip or partially isolated

device the difference is probably 0.05 hours. The total labour time saving can be roughly approximated as 0.005h to 0.01h per unit.

There are other factors to consider such as the long term reliability of the isolation and the much reduced chances of failure at isolation testing of equipment where the associated cost of rectifying these defects is very high.

By comparison the ISOWATT218 and ISOWATT220 use a more expensive plastic molding compound to achieve good thermal conductivity and a more complex molding process than the standard SOT-93/TO-218 and TO-220 packages. Consequently the price of an ISOWATT218 or ISOWATT220 device is slightly higher than the equivalent standard non-isolated device.

Even with this cost adder most users will benefit from a direct cost saving by using ISOWATT218 or ISOWATT220 devices.

CONCLUSIONS

Tests have shown that the ISOWATT218 and ISOWATT220, when mounted on a heatsink with thermal compound, have an R_{th} very close to that of the equivalent standard package with an isolation washer. When mounted with a screw, the torque used is not so critical as for the conventional packages.

Even considering a worst case situation, any slight increase in R_{th} due to the ISOWATT218 or ISOWATT220 package is negligible compared with the overall R_{th} from junction to ambient which with moderate heatsinks will be greater than 10°C/W. Any small increase is more than compensated for by the convenience of the ISOWATT package. From an overall cost point of view the ISOWATT218 and ISOWATT220 represent a saving compared with the conventional packages. The construction of the ISOWATT218 makes it much easier for the equipment to respect the safety standards which may be required.

Table 1A

SOT-93/TO-218		SOT-93 + mica	ISOWATT218	
R _{th} °C/W junction-case	R _{th} °C/W junction-heatsink	R _{th} °C/W junction-heatsink	R _{th} °C/W junction-case	R _{th} °C/W junction-heatsink
1	1.4	2.5	1.9	2.1
1.2	1.6	2.7	2.5	2.7

mica = 0.1 mm

Table 1B

TO-220		TO-220 + mica	ISOWATT220	
R _{th} °C/W junction-case	R _{th} °C/W junction-heatsink	R _{th} °C/W junction-heatsink	R _{th} °C/W junction-case	R _{th} °C/W junction-heatsink
1.2	1.9	2.9	3.1	3.3
1.8	2.5	3.5	4.1	4.3

mica = 0.07 mm

TOP-3I: Low R_{th} junction - case Insulated Package

Industrial and professional switching applications often require

- high voltages
- high speed switching with its associated high dV/dt
- high power dissipation

At the equipment level, this gives rise to a number of problems, mainly related to electromagnetic and

thermodynamic problems that are specific to power electronics, due to the isolation between die, package and heatsink.

SGS-THOMSON has introduced a special package for these applications the TOP 3I.

CONSTRUCTION AND DIMENSIONS

The dimensions of the TOP 3I package are fully compatible with TO-218 devices and are fully mechanically interchangeable.

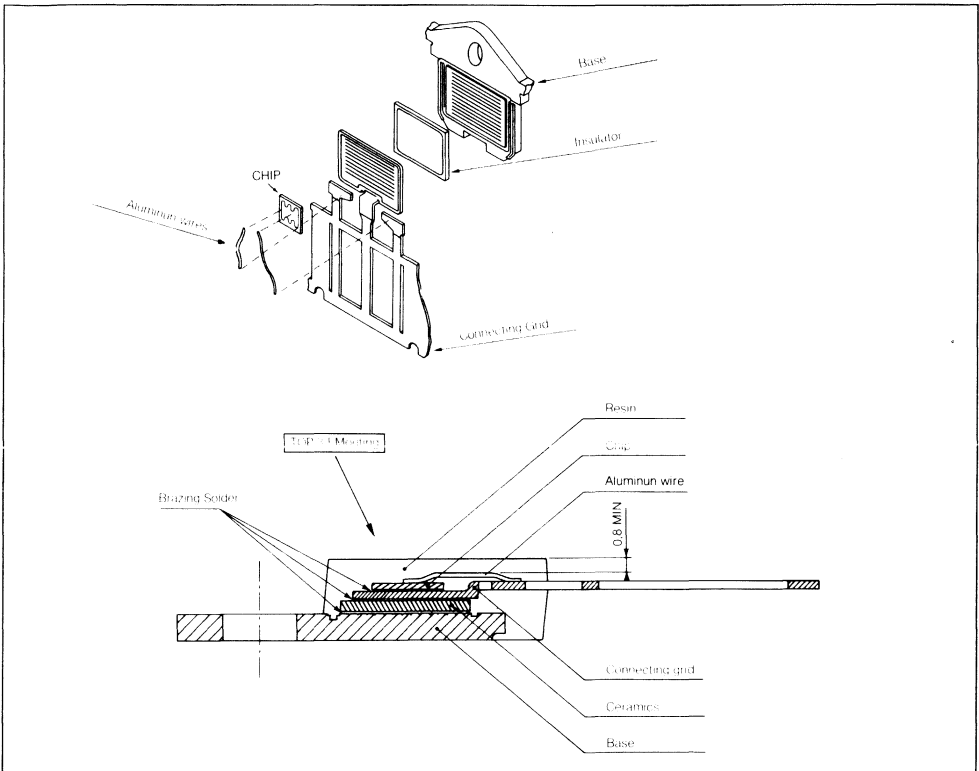
**MAIN CHARACTERISTICS OF TOP-3I PACKAGE**

Insulation voltage:	$\geq 2500V$ AC for 1 minute
Voltage between chip and heat spreader (tab):	$\geq 3500V$ DC for 1 second
R_{th} junction-case:	1.1 — 2.0 °C/W
R_{th} junction-heatsink:	1.4 — 2.3 °C/W
Stray capacitance collector-heatsink:	13pF

INTRODUCTION

This note analyses the behaviour of FASTSWITCH transistors during turn-on with a collector voltage greater than the BV_{CEO} .

In a switching power supply, as shown in fig. 1, the power device is subject to a high collector voltage and a high current during turn-on and the duration of crossover depends on the reverse recovery time "t_{rr}" of the diode. An extension of the forward bias safe operating area beyond the BV_{CEO} point allows the switching power supply designer to choose a power device most suited for the application.

The simplified application shown in fig. 1 illustrates a flyback converter and associated waveforms.

In the continuous mode of operation the transformer imposes the voltage $V_{CE} = V_{IN} + n \cdot V_O$ on the collector of the power device. This voltage is applied to the collector during turn-on, and as stated previously its duration depends on the reverse recovery time, t_{rr} of the diode.

$$n = \text{the transformer turns ratio } N1/N2$$

Using the classic FBSOA a power device with a BV_{CEO} greater than $V_{IN} + n \cdot V_O$ would be necessary. For example, in photo 1 the turn-on behaviour of an SGSF464 FASTSWITCH transistor mounted in an off-line flyback converter is shown. In order to simulate the worst case conditions a very slow diode was used for this example.

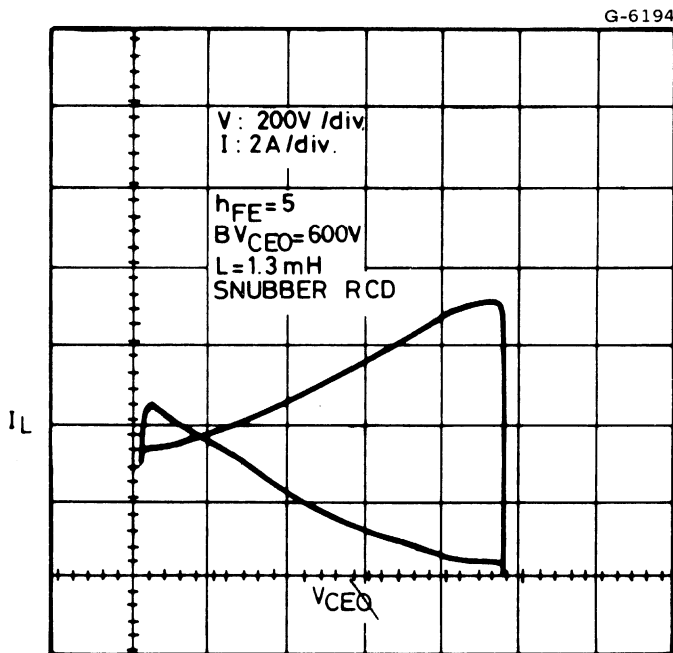
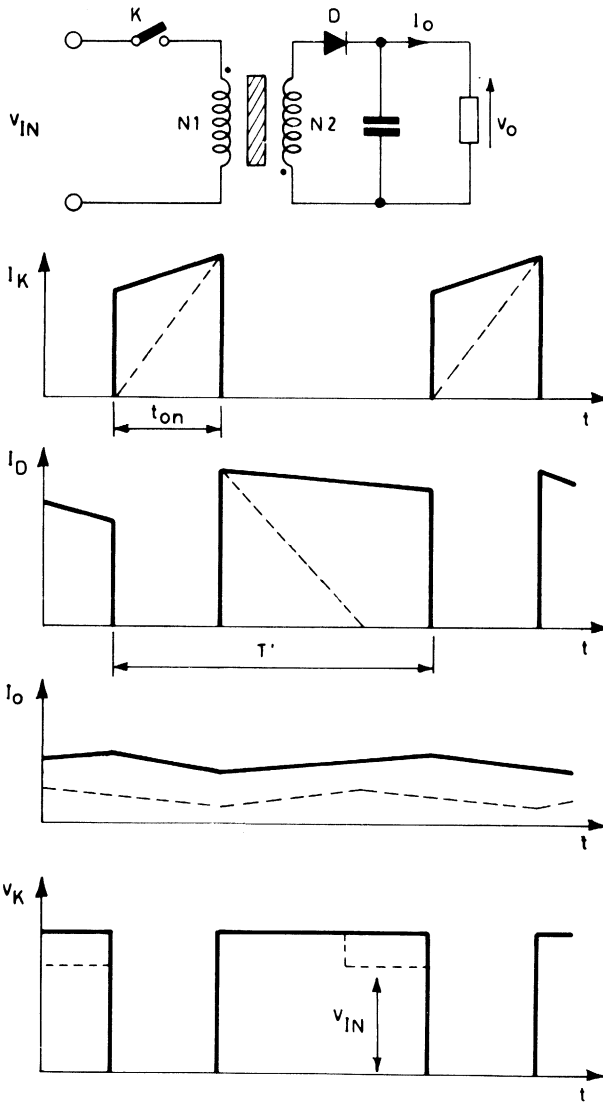

Figure 1: Isolated Flyback Converter and Associated Waveforms.



The device turns on when the collector voltage is greater than BV_{CEO} and the high voltage, high current crossover lasts about 1.5 s; this time is very long with respect of the t_{rr} of the diodes normally used in a switching power supply.

Under these conditions the normal FBSOA does not guarantee the safe operation of the device and the importance of providing the power supply designer with an FBSOA extended beyond the BV_{CEO} , usable only during turn-on, can be very useful.

In order to evaluate the FBSOA beyond BV_{CEO} , the following difficulties were encountered:

- Measurement parameter control (T.U.T. collector voltage and current, I_C max - V_{CE} max crossover duration)
- T.U.T. failure caused by E_S/b .

These difficulties were solved by using the test circuit, whose principal schematic is shown in fig. 2. The complete schematic is shown in fig. 3. Measurements were recorded under the conditions of controlled I_C , V_{CE} and I_C max - V_{CE} max crossover duration.

Photo 1: SGSF464 Turn-off Waveforms for a Flyback Converter with a Slow Diode.

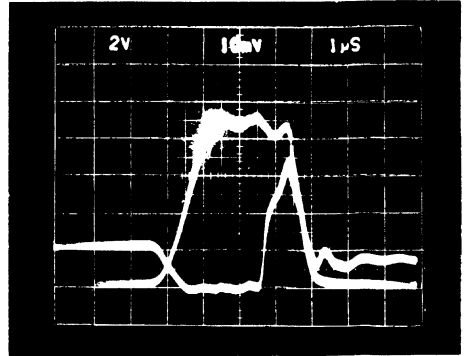

$I_C = 5A/div$; $V_{CE} = 200 V/div$; $BV_{CEO} = 600 V$

Figure 2: Measurement Circuit.

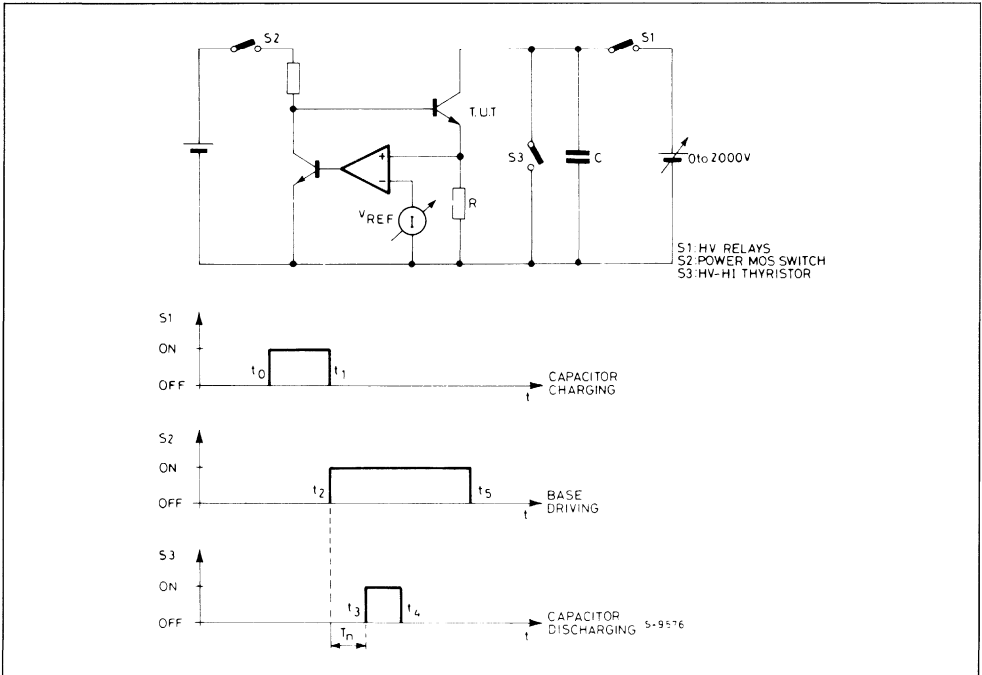
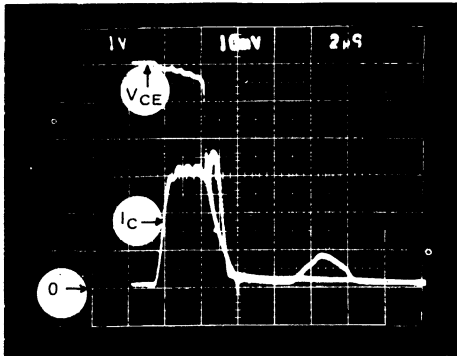

Photo 2: Collector Voltage and Current Waveforms of the Transistor Under Test.



$t = 2 \text{ ms/div}; I_C = 2/\text{div}; V_{CE0} = 100 \text{ V/div.}$

The high slew-rate comparator controls the base current by sensing the voltage across the resistance 'R'. V_{CE} falls very quickly, while the base is still forward biased, and so avoiding $E_{s/b}$ breakdown. The BV_{CE0} of the SGSF461 is about 400 V.

Photo 2 shows the typical waveforms obtained by using this test circuit. In a real case, even considering normal collector voltages, turn-on times are much shorter.

The device turn-on was further investigated by using the test circuit shown in fig. 4, in this circuit the worst case conditions were simulated by using slow diodes.

Figure 4: Application Circuit.

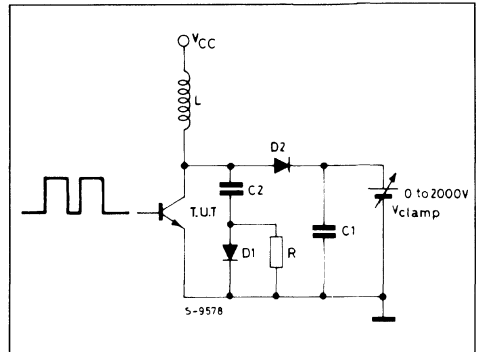
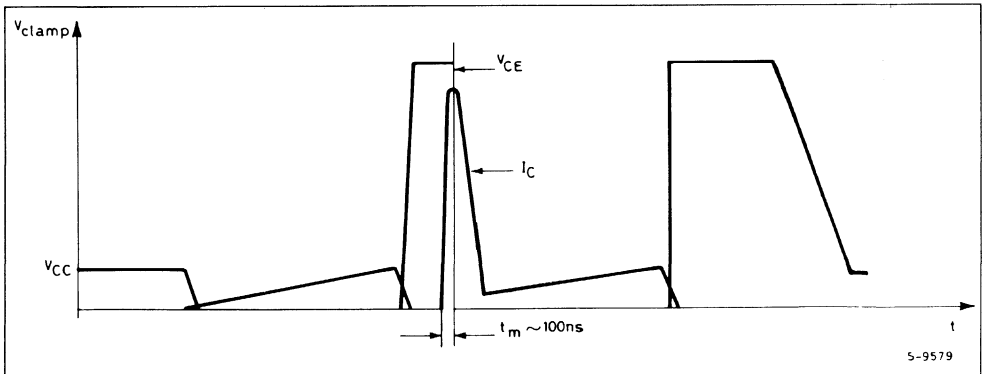

Figure 5: Current Voltage and Collector Waveforms.



During its recovery, the diode behaves as a short circuit between the collector and V_{CLAMP} . The collector current then rises with a constant voltage (V_{CLAMP}) until the charge in the diode is completely recovered. (fig. 6).

After recovery the diode blocks the voltage supply to the collector. The collector is independent of V_{CLAMP} and it is connected to the inductor only

which behaves as a current generator (Fig. 7). Consequently the initial value of collector current is the same as the current in the inductor. The voltage on the collector decreases to the V_{CEsat} value. This phenomenon can be seen clearly from the load line in fig. 8, the operating point moves from right to left on the locus.

In the same figure the snubbed turn off is shown.

Figure 6: Diode in Reverse Recovery.

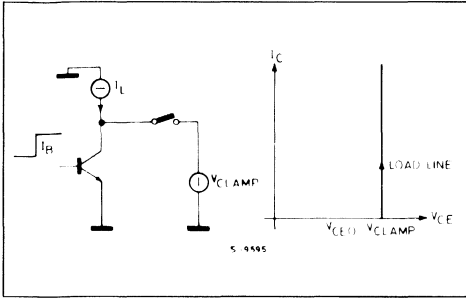

Figure 7: Blocked Diode.

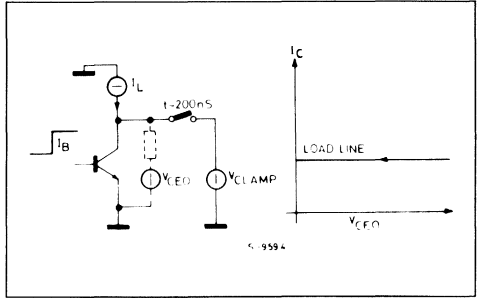
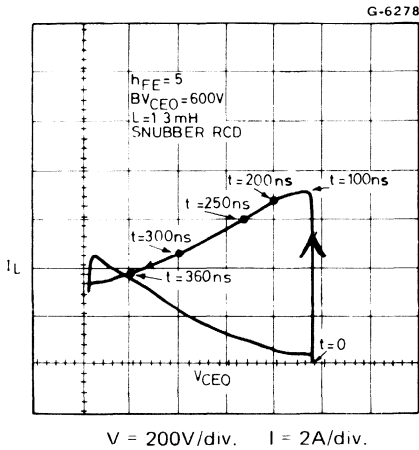

Figure 8: Load Line Shaping for SGSIF414 and SGSF444



CONCLUSION

Characterization of FASTWITCH transistors beyond the BV_{CEO} point permits better use in switching power supply designs, since in most cases the load line shape and switching times allow the designer to use the devices beyond the BV_{CEO} . This way devices with a lower voltage rating can be used giving a larger saving in cost plus the other well known advantages of the FASTSWITCH family such as shorter switching times and lower power dissipation.

Figure 9: Extension of Safe Operating Area for SGSF425.

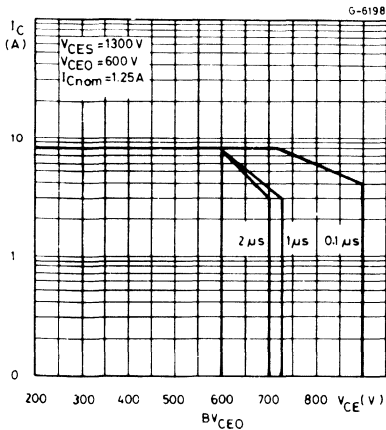

Figure 10: Safe Operating Area for SGS F425.

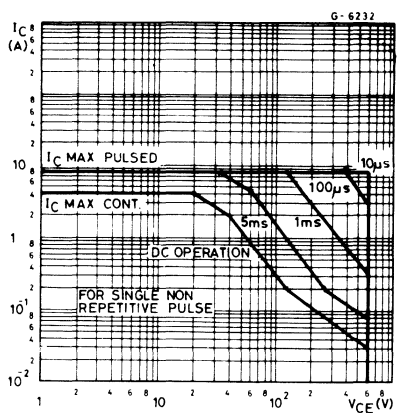

Figure 11: Extension of Safe Operating Area for SGSF422.

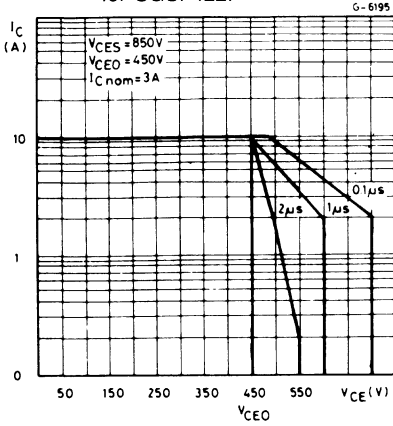

Figure 12: Safe Operating Area for SGSF422

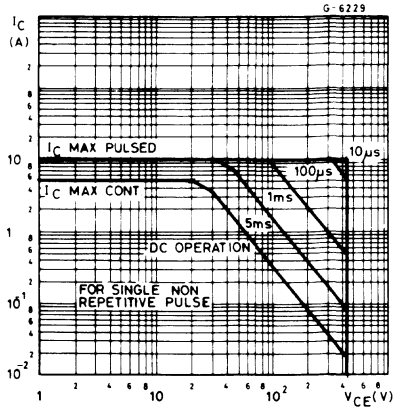

Figure 13: Extension of Safe Operating Area for SGSF442.

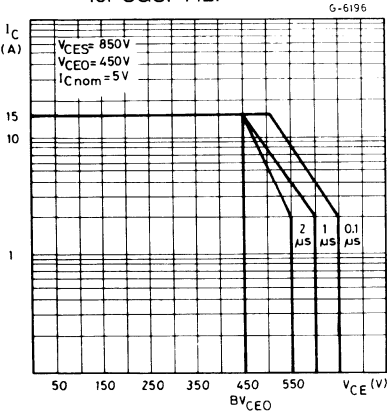

Figure 14: Safe Operating Area for SGSF442.

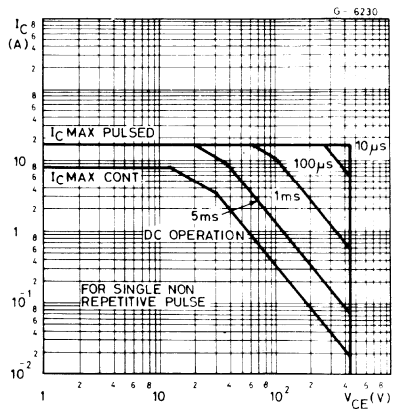
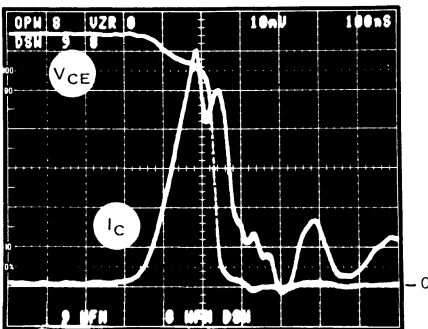

Figure 15: Turn-on for SGSF442.

a) Collector Current and Voltage Waveform



$I_C = 2A/div;$ $V_{CE} = 100V/div;$ $I_B = 1A$

b) Load Line.

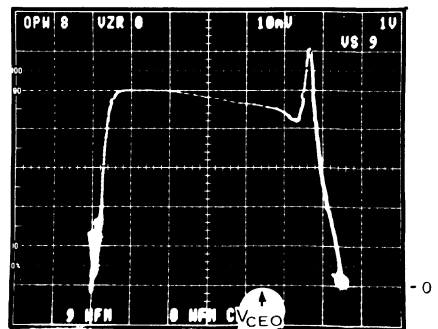

$I_C = 2A/div;$ $V_{CE} = 100V/div;$ $BV_{CEO} = 450V$

Figure 16: Extension of Safe Operating Area for SGSF462

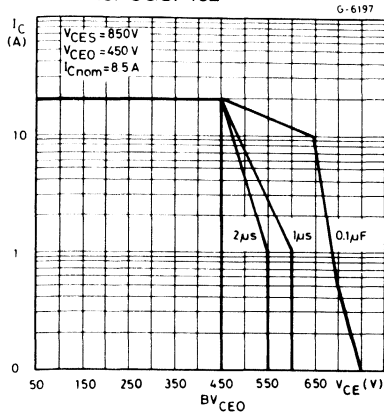

Figure 17: Safe Operating Area for SGSF462.

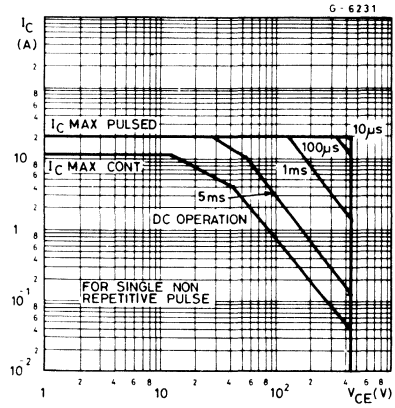
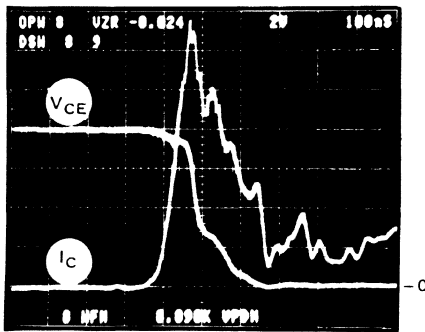

Figure 18: Turn-on for SGSF462.

a) Collector Current and Voltage Waveform



$I_C = 2A/div.$; $V_{CE} = 200V/div.$; $I_B = 1.5A$

b) Load Line.

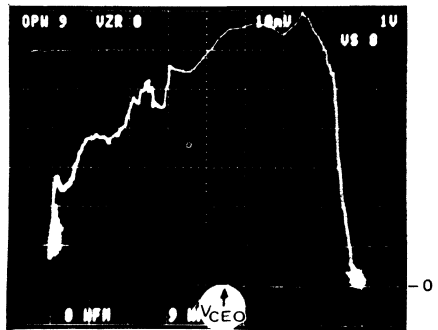

$I_C = 2A/div.$; $V_{CE} = 100V/div.$; $BV_{CEO} = 450V$

Figure 19: Extension of Safe Operating Area for SGSF444

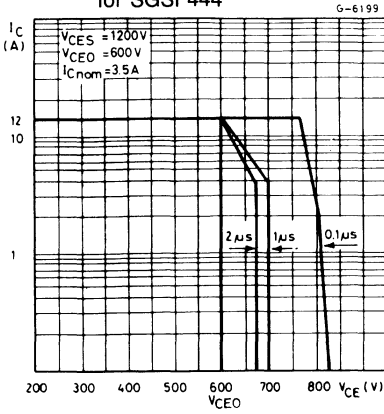

Figure 20: Safe Operating Area for SGSF444.

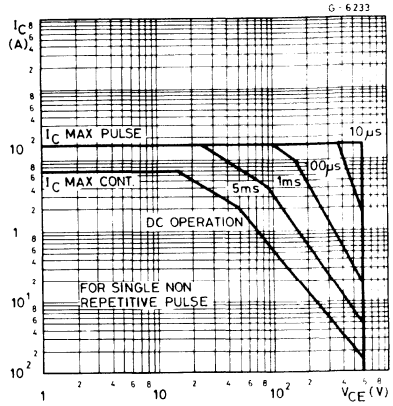
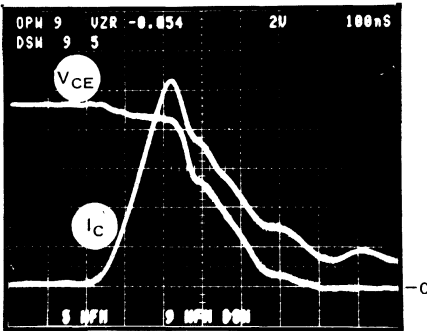
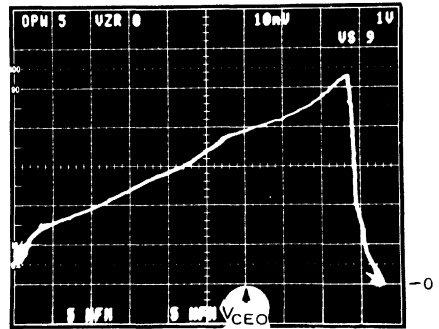

Figure 21: Turn-on for SGSF444.
a) Collector Current and Voltage Waveform



$I_C = 2A/div.$; $V_{CE} = 200V/div.$; $I_B = 1A$; $V_{CEO} = 600V$

b) Load Line.



$I_C = 2A/div.$; $V_{CE} = 100V/div.$

Figure 22: Extension of Safe Operating Area for SGSF464

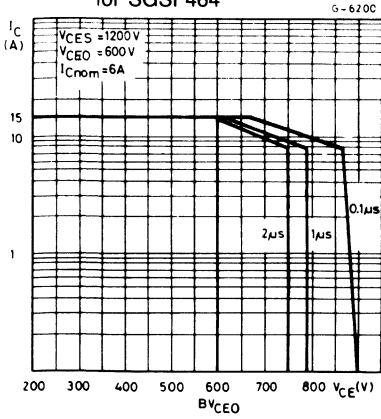

Figure 23: Safe Operating Area for SGSF464.

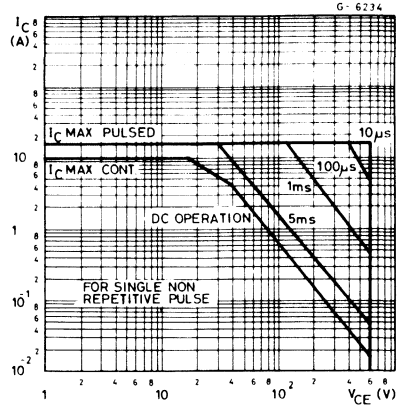
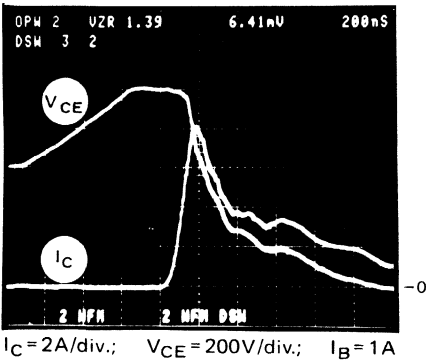
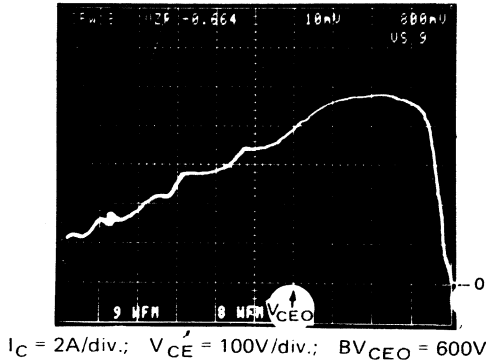

Figure 24: Turn-on for SGSF464.

a) Collector Current and Voltage Waveform



b) Load Line.



A designer using switching transistors needs an answer to the following questions:

What are the current sharing requirements between paralleled transistors?

What base current is necessary if the transistor is used with a reduced collector current?

What are the transistor conduction losses?

How robust is the transistor in case of overload?

The conventional data sheets often do not give the data necessary to answer these questions. For many years, SGS-THOMSON have strived to specify the "SUPERSWITCH 1" series of transistors in a manner that gives the maximum information necessary for the efficient development of circuits. The data sheets of the new FASTSWITCH family are even more complete.

The principal characteristics of switching transistors are the blocking voltages V_{CEOSUS} and V_{CEX} , the nominal collector current I_{CSAT} , the safe operating area for switching, the switching times and the "robustness" as specified by the "accidental overload areas".

A switching transistor normally operates with a junction temperature above 25°C. Hence circuit designers require transistor characteristics at higher temperature such as a junction temperature (T_j) of 100°C. Before considering the technical details of the new FASTSWITCH transistor series, it is necessary to examine the most important characteristics of switching transistors. In examining these characteristics a low voltage transistor, the BUW 48, is used as an example.

THE BLOCKING VOLTAGE

Figure 1 is part of the BUW 48 data sheet. This figure provides information for a preliminary appreciation of the transistor characteristics: since the voltage V_{CEOSUS} is given as 60 V, this transistor should be capable of switching a voltage of about 50 to 60 V in applications where switching aid networks (snubbers) are not used (this case will be described in greater detail in the paragraph "safe operating area"). In most circuits which are operating from a low voltage supply, the voltage V_{CEOSUS} of the transistor is chosen to be slightly above the supply voltage V_A .

Since the voltage V_{CEX} is specified at 120 V, the transistor is able to support a collector-emitter voltage of up to 120 V. However, it will be shown later that the collector current at turn-off must be zero before the collector-emitter voltage can exceed the specified V_{CEOSUS} value. A switching aid circuit (RCD, etc...) connected between the collector and emitter, allows the collector current to decay to zero before the voltage has exceeded the V_{CEOSUS} value. If one does not to decay to zero before the

voltage has exceeded the V_{CEOSUS} value. If one does not wish to use a switching aid circuit, the voltage between the collector and emitter must remain below the V_{CEOSUS} value; (i.e. 60 V in the example).

Figure 1 - An extract from the BUW 48 data sheet. The principal characteristics are specified on the upper right hand side.

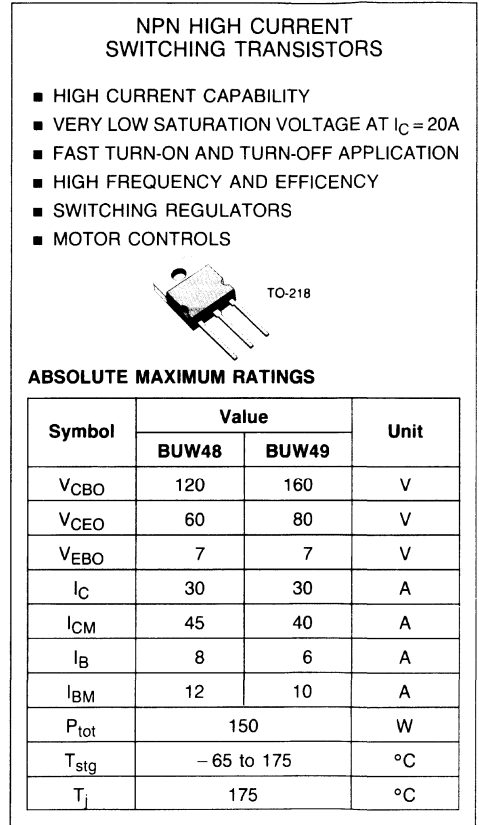

THE COLLECTOR CURRENT

While operating at its nominal current level I_{CSAT} , the transistor has a normal gain and a normal saturated collector-emitter saturation voltage. The voltage V_{CESAT} of transistor BUW 48 is 1.4 V for a collector current of 40 A, provided the base current is not less than 4 A. These details are given in figure 3. In contrast, at a collector current equal in value to I_{CM} , neither the gain nor the saturation voltage is specified. It is thus recommended to use the transistor with a collector current of the same order of magnitude as I_{CSAT} or below.

Figure 2 - The collector - emitter voltage at turn-off

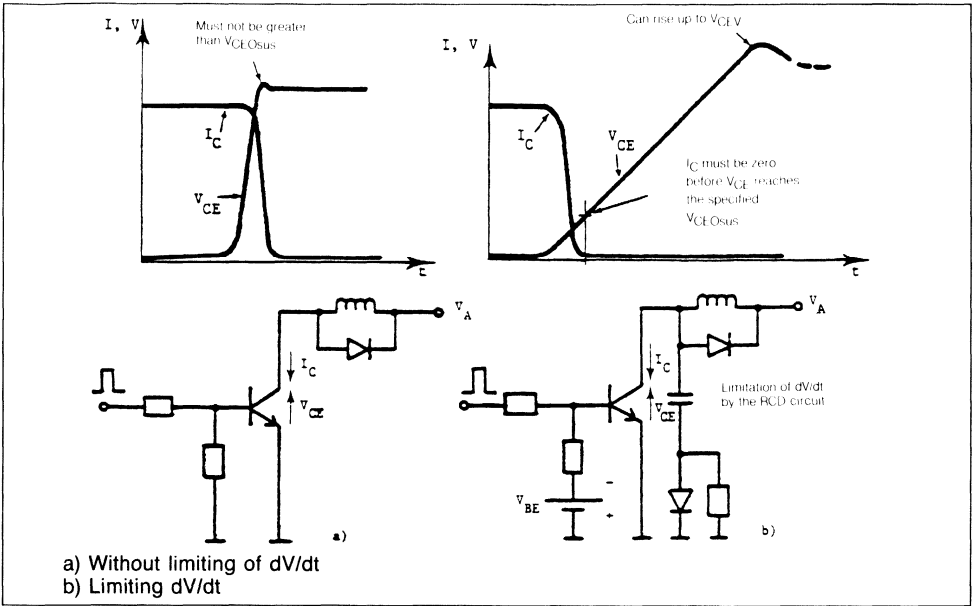

Figure 3 provides guaranteed maximum saturation voltage data (see "MAX" column of figure 3). However it is necessary to treat this data with caution: in fact, on closer inspection of figure 3, it can be seen that all the data are specified at a junction temperature T_J of 25°C "except where specified otherwise". Since no exceptions are stated in the figure the data is specified uniquely at 25°C. Figure 4 provides an indication of the behaviour of the transistor saturation voltages at a realistic operating temperature.

The curve of V_{CEsat} as a function of I_C shows that the collector-emitter voltage is 0.83 V (typically) at a collector current I_C of 40 A with a base current of not less than 4 A. For a junction temperature T_J ,

of 125°C, (see dotted line in figure 4), the saturation voltage becomes 0,93 V (typically). If it is assumed that the worst sample of this type of transistor has the same temperature coefficient as the typical sample, the saturation voltage V_{CEsat} at T_J equal to 125°C can be evaluated in the following manner:

$$V_{CEsat} \max (125^\circ\text{C}) = 1.4V \frac{0.93 \text{ V}}{0.83 \text{ V}} = 1.7 \text{ V at } 40 \text{ A}$$

The improved data sheets of the "FASTSWITCH 2" series of transistors specify all the saturation voltages at 25 and 100°C as shown in figure 5.

Figure 3 - The specification of saturated voltages of the BUW 48.

ELECTRICAL CHARACTERISTICS **

Symbol	Test Conditions	Min	Typ	Max	Unit
V_{CEsat}^*	BUW 48 $I_C = 20 \text{ A } I_B = 2.0 \text{ A}$			0.6	V
	$I_C = 49 \text{ A } I_B = 4.0 \text{ A}$			1.4	V
	BUW 49 $I_C = 15 \text{ A } I_B = 1.5 \text{ A}$			0.5	V
	$I_C = 30 \text{ A } I_B = 3.0 \text{ A}$			1.2	V
V_{BEsat}^*	BUW 48 $I_C = 40 \text{ A } I_B = 4.0 \text{ A}$			2.1	V
	BUW 49 $I_C = 30 \text{ A } I_B = 3.0 \text{ A}$			2.0	V

* Measured with a pulse $t_p = 300 \mu\text{s}$ ** $T_J = 25^\circ\text{C}$ except otherwise stated. The asterisks specify that the data is valid only at $T_J 25^\circ\text{C}$

DEVICES IN PARALLEL

On examining the temperature coefficient of the collector-emitter and the base-emitter voltages, it is established that these coefficients become positive at high current levels.

The collector-emitter junction of a saturated transistor behaves like a low value resistance with a positive temperature coefficient. At high currents the base-emitter voltage also has a positive temperature coefficient.

This may be surprising at first thought, since text book physics dictates that this coefficient is negative. A closer examination of the base-emitter junction of power transistors provides an explanation of this apparent contradiction: the base-emitter junction behaves like a resistance connected in series with a diode.

The temperature coefficient of the diode is negative, whereas that of the resistance is positive: with relatively high currents, the positive temperature coefficient of the resistance dominates. Thus, when considering "devices in parallel" without the use of external compensating resistances, the current sharing between the transistors in parallel improves at high collector currents.

The maximum spread of the base-emitter voltage is also given in figure 4. It is thus possible to evaluate the current sharing between transistors in parallel.

Figure 4 - The collector-emitter saturation voltage of the BUW 48

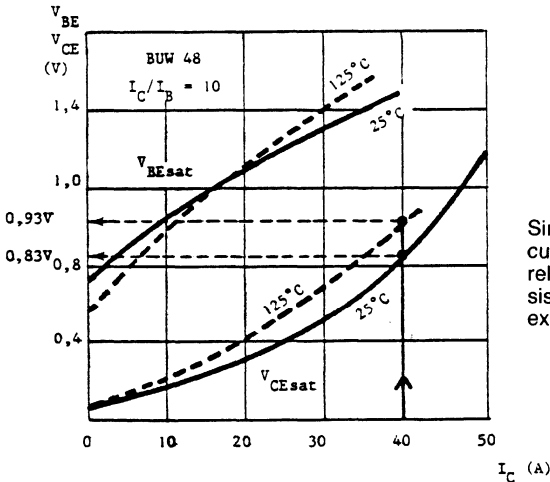

SATURATION VOLTAGE-GAIN

The nominal collector current I_{Csat} must not be considered as an absolute limit. At a collector current of I_{Csat} , the transistor still has a high gain and a low saturation voltage. "Forced gain" is defined as the collector current divided by the base current which are determined by the collector and the base circuits, respectively. For the BUV 50, the nominal collector current I_{Csat} is 20 A as stated in figure 5. A base current of 2 A is necessary to obtain a saturation voltage of 0.6 V. Thus with a collector current of 20 A, the transistor is in saturation with a forced gain of 10. If the same transistor needs to be used at 24 A, it is necessary to increase the base current to 3 A.

The collector-emitter voltage then reaches 0.8 V. Thus the gain decreases when the transistor is used with the collector current greater than I_{Csat} . In the example, it is reduced from 10 at 20 A to 8 at 24 A.

When using the BUV 50 at a collector current of only 10 A instead of 20 A, the collector-emitter voltage is reduced to 0.4 V and the gain increases to 20, (see figure 5).

As a result there are two interesting alternatives for circuit designers:

- 1) When, for cost effectiveness, the transistor must be exploited to the maximum, it can be used with a collector current greater than I_{Csat} . The base current must be increased as a consequence.
 - a) The collector-emitter saturation voltage decreases by 20 to 30%.
 - b) The forced gain doubles.
 - c) The base drive circuit losses are decreased by 75%.
 - d) The switching losses are reduced.
- 2) When the objective is to improve the reliability and efficiency of the equipment, the transistors may be under-rated. In using the BUV 50, at half its nominal collector current:
 - a) The collector-emitter saturation voltage decreases by 20 to 30%.
 - b) The forced gain doubles.
 - c) The base drive circuit losses are decreased by 75%.
 - d) The switching losses are reduced.

Since the switched current is defined by the circuit and its load, the second alternative ("better reliability and efficiency") leads one to use a transistor with a higher nominal collector current, (for example, the BUV 60).

Figure 5 - BUV 50

ELECTRICAL CHARACTERISTICS

Symbol	Test Conditions	Min	Typ	Max	Unit
V_{CEsat}	$T_j = 25^\circ\text{C}$ $I_C = 24\text{ A}$ $I_B = 3.0\text{ A}$		0.7	1.2	V
	$T_j = 100^\circ\text{C}$		0.9	1.8	V
V_{CEsat}	$T_j = 25^\circ\text{C}$ $I_C = 20\text{ A}$ $I_B = 2.0\text{ A}$		0.6	0.9	V
	$T_j = 100^\circ\text{C}$		0.75	1.5	V
V_{CEsat}	$T_j = 25^\circ\text{C}$ $I_C = 10\text{ A}$ $I_B = 0.5\text{ A}$		0.4	0.8	V
	$T_j = 100^\circ\text{C}$		0.5	0.9	V
V_{BEsat}	$T_j = 25^\circ\text{C}$ $I_C = 24\text{ A}$ $I_B = 3.0\text{ A}$		1.35	1.7	V
	$T_j = 100^\circ\text{C}$		1.45	1.9	V
V_{BEsat}	$T_j = 25^\circ\text{C}$ $I_C = 20\text{ A}$ $I_B = 2.0\text{ A}$		1.25	1.6	V
	$T_j = 100^\circ\text{C}$		1.25	1.7	V

Note: All the saturation voltages are specified at $T_j = 25^\circ\text{C}$ and at $T_j = 100^\circ\text{C}$

Figure 6 - Measurement of switching times with a resistive load. The measurement is read, between 10 and 90% of the current.

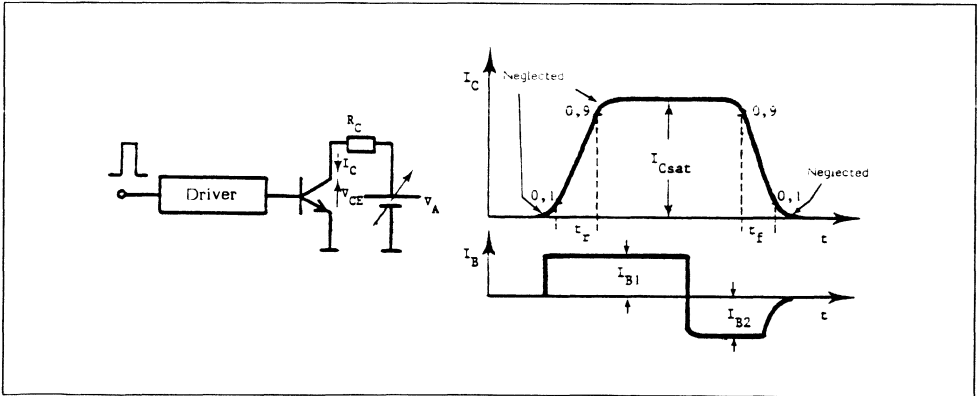

SPECIFICATION OF SWITCHING TIMES

The specified switching times for power transistors are traditionally measured at a junction temperature of 25°C with a resistive load in the collector circuit (figure 6). In applications, transistors are used with inductive loads with free-wheeling diodes and operate at a higher junction temperature. Two transistors having identical performances under the specified conditions in the data sheet, can give very different performances when operating in an equipment. For this reason, the switching times of the transistors should be specified in a way close to the real world operating conditions.

How to explain these differences in switching performance?

A critical examination of the measurement conditions gives part of the answer. The rise and fall times of the collector current are measured as the time between 10% and 90% of the changing current (figure 6). What happens before and after these measurement points is neglected. But in the case of operating with an inductive load, it is before and after these measurement points that the situation becomes interesting (fig. 7). The current "tail" which can appear towards the end of the fall time t_f of the collector current, can generate a large per-

SPECIFICATION OF SWITCHING TIMES (Cont'd)

centage of the turn-off losses. But when the measurement is taken with a resistive load, this tail often becomes invisible or disappears below the 10% measurement limit. A similar situation exists a turn-on. In this case there can often be enormous differences between the presently defined specifications and the real operating conditions due to the dynamic turn-on saturation voltage $V_{CEsat\ dyn}$.

Figure 7 - The turn-off with a current tail: although the fall time t_f may be small, the supplementary losses due to the current tail may not be negligible.

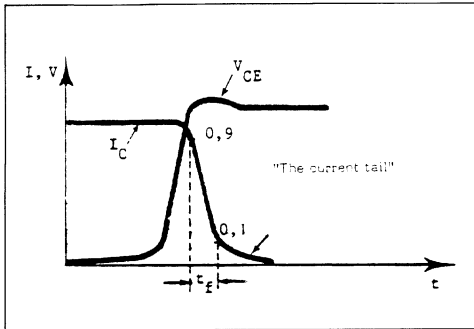

NEW SPECIFICATION FOR TURN-ON SWITCHING

When a transistor turns on with a resistive load, the collector current rises while there is a corresponding reduction in the collector-emitter voltage. In the case of switching an inductive load with

a free-wheeling diode, the conditions are different. At the start of transistor conduction, the free-wheeling diode becomes at first a short-circuit while the collector current rises at a specific dI_C/dt rate (figure 8). During this phase, the collector-emitter voltage V_{CE} is equal to the voltage V_A , less the voltage drop across the parasitic inductance L_p . At this instant the collector-emitter voltage is given by:

$$V_{CE}(t_{sc}) = V_A - L_p \frac{dI_C}{dt}$$

It is thus preferable to specify the gradient dI_C/dt which can occur during the transistor turn-on, rather the rise-time t_r with a resistive load.

The gradient dI_C/dt is specified for the FAST-SWITCH series of transistors in their data sheets. The second phase of the turn-on period of the transistor occurs after the time t_{sc} has elapsed. The collector-emitter voltage decreases rapidly in this phase. However, it does not reach a minimum steady state saturation value immediately. It first goes through a phase defined as the "dynamic collector-emitter saturation voltage" or " $V_{CEsat\ dyn}$ ".

This phase is particularly noticeable in the case of high voltage transistors. The losses due to the $V_{CEsat\ dyn}$ voltage must be taken into account when operating at high voltages and high frequencies. As regards to the new transistors, the dynamic saturation voltage is specified at two precise instants, for example 2 and 4 μs after the start of conduction (figure 9).

Thus the specified values for dI_C/dt and $V_{CEsat\ dyn}$ allow more accurate calculation of the switching losses at turn-on.

Figure 8 - The turn-on of a transistor with a conducting free-wheeling diode. The transistor constraints are different in comparison to the resistive load case. The voltage V_{CE} remains high during the time t_{sc} .

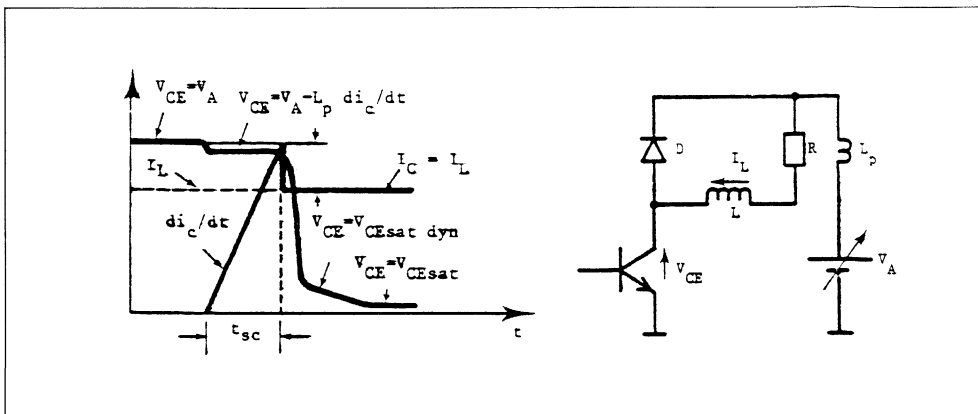
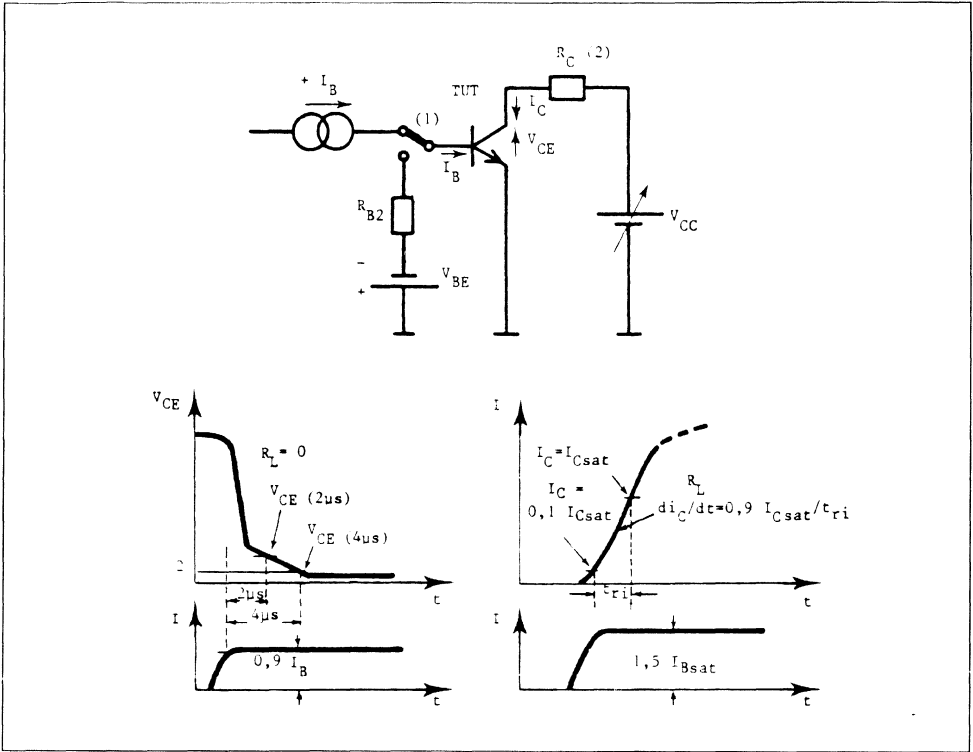

Figure 9 - Method of measurement for the determination of switching losses. V_{CEsat} dyn is measured with a resistive load (the current source). di_C/dt is measured with the resistive load short-circuited.



IMPROVED SPECIFICATION OF THE TURN-OFF SWITCHING

The turn-off switch is more critical than the turn-on switching. When the transistor is working without switching aid circuits - which is possible with the new transistors - the switching losses at turn-off must be accurately predicted. In the past, the equation $E_{off} = 0.5 \cdot I_C \cdot V_A \cdot t_f$ has been used to approximately calculate the switching losses at turn-off. A more precise method of predicting switching losses is essential at high powers. When using an equation the following effects have been neglected:

- a) During the storage time the collector-emitter voltage V_{CE} becomes greater than the saturation voltage V_{CEsat} .
- b) The parasitic inductances present in the circuit cause supplementary losses.

When considering fast transistors where a 10 A current is being switched off in less than 10 ns, the slope di_C/dt has a value of $1000 A/\mu s$. This gradient would cause a voltage of 100 V across a parasitic inductance of only $0.1 \mu H$. A similar problem exists in the use of transistors at high power (such as 400 A switched in 300 ns).

It can be seen from figure 10, that the voltage V_{CE} rises from V_{CEsat} to a value $V_A + \Delta V$ gradually rather than instantaneously. Hence the time t_c has been specified in the data sheets of the FAST-SWITCH transistors.

Hence it is possible to calculate accurately the turn-off losses of a transistor operating without switching aid circuits. The turn-off losses can be calculated using equation (1).

$$E_{off} = \underbrace{0.5 I_{Cend} V_A t_c}_{\text{"A"}} + \underbrace{0.5 t_{tl} 0.1 I_{Cend} V_A}_{\text{"B"}} + \underbrace{0.5 L_p I^2 C_{end}}_{\text{"C"}} \quad (1)$$

Figure 10

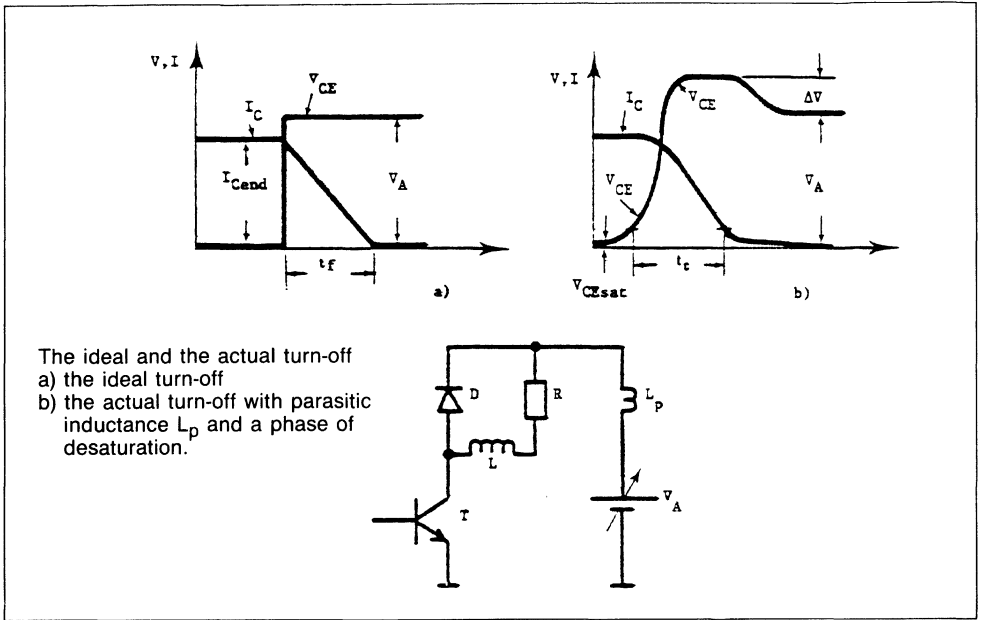

The terms A and B depend on the transistor, on its operation, on the junction temperature and on its drive circuit. The term C is a function of the collector current and the parasitic inductances of the circuit. Thus this term is principally dependent on the physical lay-out of the circuit. The times t_c and t_{ij} are specified in the new data sheets.

TRANSISTOR FAILURE

Secondary breakdown may occur when the transistor is subjected simultaneously to a high current and a high voltage for a certain amount of time. This condition causes localised heating of the die followed by a current concentration and finally transistor failure. Thus it should be re-stated that transistor failure due to secondary breakdown occurs when the following three conditions exist simultaneously: high voltage and high current during a prolonged time. It is necessary to consider the operating constraints of modern transistors.

If a high voltage transistor such as the BUX 98 is operated in the linear mode with a collector voltage of 400 V and a collector current of 40 A simultaneously, secondary breakdown occurs after about 80 to 100 μ s. However, while operating the transistor in the switching mode, secondary breakdown does not occur since the transistor is subjected to the full voltage and current rating for only a fraction of a microsecond. Nevertheless, the transistor can

fail in a very short period of time if the collector-emitter voltage increases above the limit specified in the RBSOA. If the base current of a switching transistor is insufficient, the transistor desaturates and the collector-emitter voltage increases while a high collector current continues to flow.

Hence the transistor is accidentally operated in the linear mode. This leads to over-heating and second breakdown. A base drive circuit that protects the transistor against accidental desaturation is called a "self protecting driver". If the circuit is well designed, it is possible to detect this fault condition rapidly: show the turn-off cycle on a scope operating in the x-y mode. Compare with the specified turn-on SOA "FBSOA". If the switching cycle remains within the specified area, the transistor is operating safely. The turn-off cycle can be verified in a similar manner. The following would then remain to be checked:

- a) the state of the saturation before turn-off: (the transistor is more "robust" if turn-off is started from quasi-saturation, (figure 11).
- b) The junction temperature which can be calculated with the losses and the thermal resistance. The safe operating area is specified at a junction temperature of 125°C. If the calculated temperature is below this value, "derating" is not necessary.

OVERLOAD CAPABILITY OF SWITCHING TRANSISTORS

The overload capability of a transistor, (which is a measure of its "robustness"), is important from the point of view of economic considerations. A converter must be capable of withstanding overloads and short-circuit conditions. The precise measure of the "robustness" of transistors is necessary in order to decide whether inductances should be used to limit the rate of rise of current under overload conditions.

If the transistor is capable of supporting the supply voltage and the over-rated current, it is possible to avoid using such inductances. The "accidental overload area" can be seen in figure 12: the astonishing "robustness" of modern switching transistors can be seen in this figure. The BUX 98, ($I_{Csat} = 20\text{ A}$, $V_{CE0sus} = 400\text{ V}$), is capable of operating with a collector current of 60 A and a voltage of 400 V for a period of 20 μs . This impulse of 24 kW can be applied at a junction temperature of 125°C. The margin of security is comfortable if it is assumed that the transistor is

operating at a collector current of 20 A and that the response time for the detection of the overload is about 2 μs .

It should be noted that for currents greater than the I_{CM} value of 60 A, the number of overloads is limited to 3000 since pulses of 110 A 350 V 5 μs can cause irreversible damage to the transistor after a certain number of pulses. The overload capability of the transistor has been discussed thus far. It is now necessary to determine the importance of overload capability when a fault occurs. The answer can be found in the accidental overload area (FBAOA): The duration between turn-on, the detection of a fault and the turn-off may be around 3 μs by operating the transistor with an "auto-regulated, auto-protected" driver circuit or with the integrated, circuit UAA 4002, (figure 13).

The FBAOA gives the value of the current that the transistor can be subjected to during overload. However it does not state whether the specified current can be safely cut-off without damage. That specification is given in the RBACOA, (figure 12). The junction temperature must return to less than 125°C before the next overload.

Figure 11

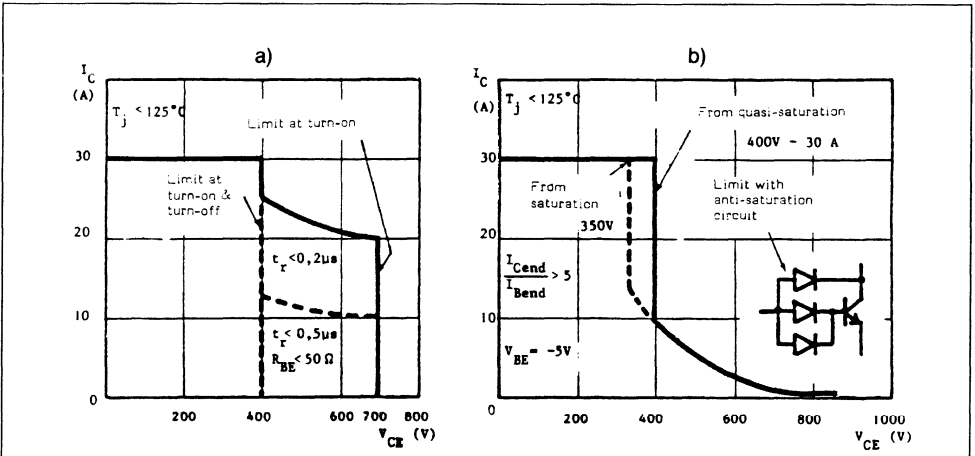

The switching safe operating areas of the BUX 98, (FSOA and RBSOA). The areas are specified at a junction temperature of 125°C. It is thus unnecessary to specify deratings as a function of the junction temperature.

Figure a) specifies the safe operating area for turn-on.
Figure b) specifies the safe operating area for turn-off.

Figure 12

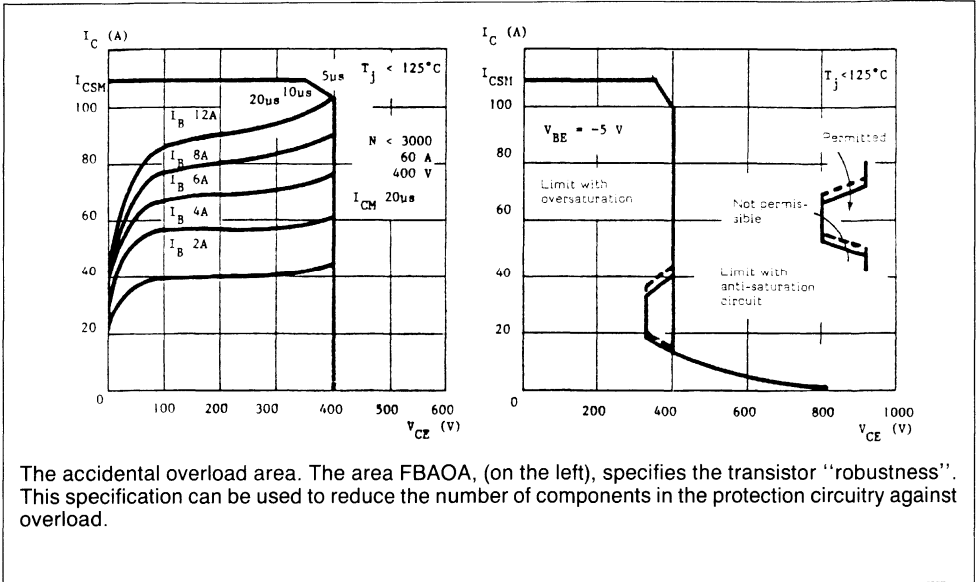
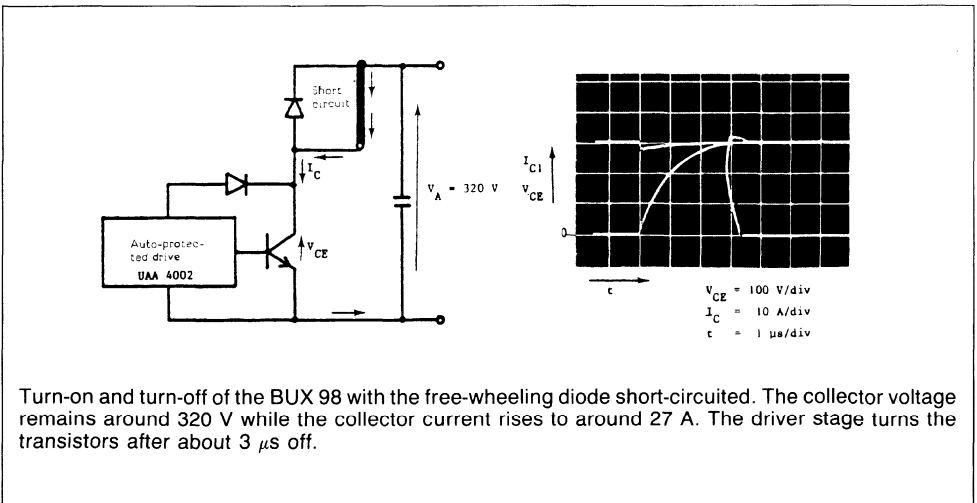

Figure 13



CONCLUSION

The very complete specification of the Fastswitch - Transistor enables a prediction of switching losses under "real world" conditions. The lay-out of protection circuits, of the base drive and of parallel

ing is greatly simplified. The cost/performance compromise of converters with Fastswitch - Transistors can be predicted and optimised thanks to these specifications.

DATASHEETS

MEDIUM POWER LINEAR AND SWITCHING APPLICATIONS

DESCRIPTION

The BD135, BD137, BD139 are silicon epitaxial planar NPN transistors in Jedec TO-126 plastic package, designed for audio amplifiers and drivers utilizing complementary or quasi complementary circuits.

The complementary PNP types are the BD136, BD138 and BD140 respectively.

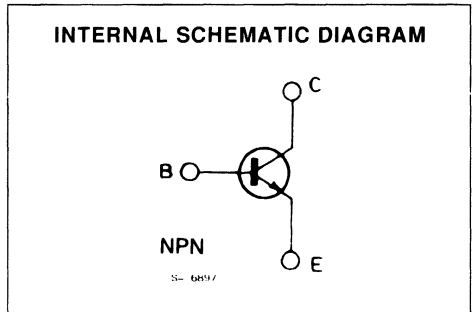
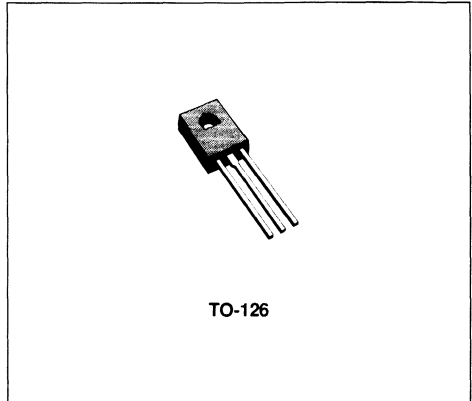

ABSOLUTE MAXIMUM RATINGS

Symbol	Parameter	BD135	BD137	BD139	Unit
V_{CBO}	Collector-base Voltage ($I_E = 0$)	45	60	80	V
V_{CEO}	Collector-emitter Voltage ($I_B = 0$)	45	60	80	V
V_{EBO}	Emitter-base Voltage ($I_C = 0$)	5			V
I_C	Collector Current	1.5			A
I_{CM}	Collector Peak Current	3			A
I_B	Base Current	0.5			A
P_{Tot}	Total Power Dissipation at $T_{case} \leq 25^\circ\text{C}$ $T_{amb} \leq 25^\circ\text{C}$	12.5			W
		1.25			W
T_{stg}	Storage Temperature	- 55 to 150			$^\circ\text{C}$
T_j	Junction Temperature	150			$^\circ\text{C}$

THERMAL DATA

$R_{th(j-case)}$	Thermal Resistance Junction-case	Max	10	°C/W
------------------	----------------------------------	-----	----	------

ELECTRICAL CHARACTERISTICS ($T_{case} = 25^{\circ}C$ unless otherwise specified)

Symbol	Parameter	Test Conditions	Min.	Typ.	Max.	Unit
I_{CBO}	Collector Cutoff Current ($I_E = 0$)	$V_{CB} = 30V$ $T_{case} = 125^{\circ}C$ $V_{CB} = 30V$			0.1 10	μA μA
I_{EBO}	Emitter Cutoff Current ($I_C = 0$)	$V_{EB} = 5V$			10	μA
$V_{CE(sus)}^*$	Collector-emitter Sustaining Voltage ($I_B = 0$)	$I_C = 30mA$ for BD135 for BD137 for BD139	45 60 80			V V V
$V_{CE(sat)}^*$	Collector-emitter Saturation Voltage	$I_C = 500mA$ $I_B = 50mA$			0.5	V
V_{BE}^*	Base-emitter on Voltage	$I_C = 0.5A$ $V_{CE} = 2V$			1	V
h_{FE}^*	DC current Gain	$I_C = 5mA$ $V_{CE} = 2V$ $I_C = 0.5A$ $V_{CE} = 2V$ All Types $I_C = 150mA$ $V_{CE} = 2V$ for BD135 for BD137, BD139	25 25 40 40		250 160	

* Pulsed : pulse duration = 300 μs , duty cycle $\leq 2\%$.

Available in h_{FE} groups ($I_C = 150mA$; $V_{CE} = 2V$)	h_{FE} group	6	Min.	Max.
		10	40	100
		16	63	160
			100	250

Safe Operating Area

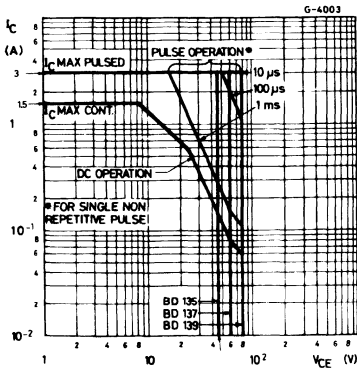

DC Current Gain

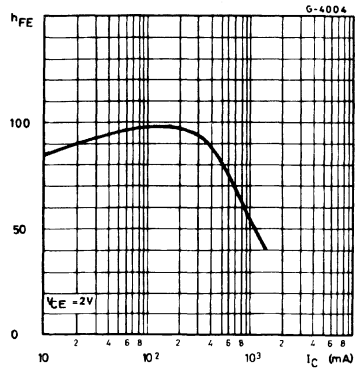

Collector-emitter Saturation Voltage.

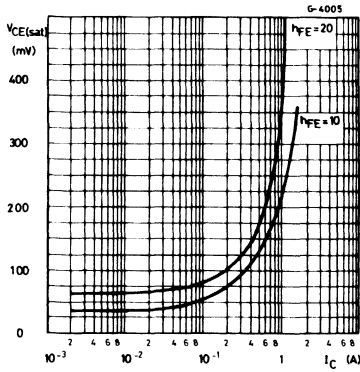

Base-emitter Voltage.

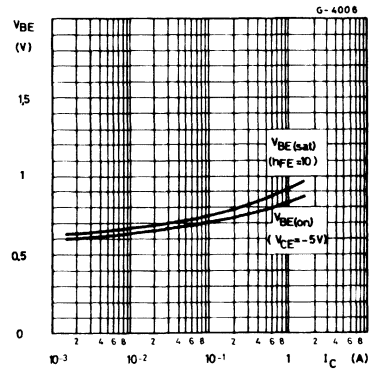

MEDIUM POWER GENERAL PURPOSE TRANSISTORS

DESCRIPTION

The BD136, BD138, BD140 are silicon epitaxial planar PNP transistors in Jedec TO-126 plastic package, designed for audio amplifiers and drivers utilizing complementary or quasi-complementary circuits.

The complementary NPN types are respectively the BD135, bd137 and BD139.

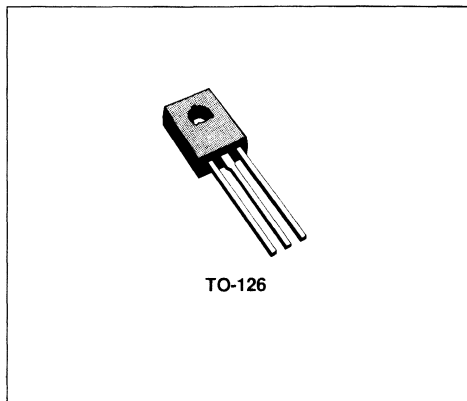

INTERNAL SCHEMATIC DIAGRAM

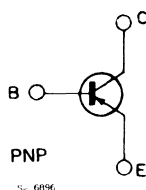

ABSOLUTE MAXIMUM RATINGS

Symbol	Parameter	BD136	BD138	BD140	Unit
V_{CBO}	Collector-base Voltage ($I_E = 0$)	- 45	- 60	- 80	V
V_{CEO}	Collector-emitter Voltage ($I_B = 0$)	- 45	- 60	- 80	V
V_{EBO}	Emitter-base Voltage ($I_C = 0$)		- 5		V
I_C	Collector Current		- 1.5		A
I_{CM}	Collector Peak Current		- 3		A
I_B	Base Current		- 0.5		A
P_{tot}	Total Power Dissipation at $T_{case} \leq 25^\circ\text{C}$ $T_{amb} \leq 25^\circ\text{C}$		12.5		W
			1.25		W
T_{stg}	Storage Temperature		- 55 to 150		$^\circ\text{C}$
T_j	Junction Temperature		150		$^\circ\text{C}$

THERMAL DATA

$R_{th\ j-case}$	Thermal Resistance Junction-case	Max	10	$^{\circ}C/W$
------------------	----------------------------------	-----	----	---------------

ELECTRICAL CHARACTERISTICS($T_{case} = 25^{\circ}C$ unless otherwise specified)

Symbol	Parameter	Test Conditions	Min.	Typ.	Max.	Unit
I_{CBO}	Collector Cutoff Current ($I_E = 0$)	$V_{CB} = -30V$ $T_{case} = 125^{\circ}C$ $V_{CB} = -30V$			- 0.1 - 10	μA μA
I_{EBO}	Emitter Cutoff Current ($I_C = 0$)	$V_{EB} = -5V$			- 10	μA
$V_{CE(sus)}^*$	Collector-emitter Sustaining Voltage ($I_B = 0$)	$I_C = -30mA$ for BD136 for BD138 for BD140	- 45 - 60 - 80			V V V
$V_{CE(sat)}^*$	Collector-emitter Saturation Voltage	$I_C = -0.5A$ $I_B = -0.05A$			- 0.5	V
V_{BE}^*	Base-emitter Voltage	$I_C = -0.5A$ $V_{CE} = -2V$			- 1	V
h_{FE}^*	DC current Gain	$I_C = -5mA$ $V_{CE} = -2V$ $I_C = -0.5A$ $V_{CE} = -2V$ All Types $I_C = -150mA$ $V_{CE} = -2V$ for BD136 for BD138, BD140	25 25 40 40		250 160	

* Pulsed : pulse duration = 300 μs , duty cycle $\leq 2\%$.
Available in h_{FE} groups
($I_C = -0.15A$ $V_{CE} = -2V$)

h_{FE} group	Min.	Max.
6	40	100
10	63	160
16	100	250

Safe Operating Areas.

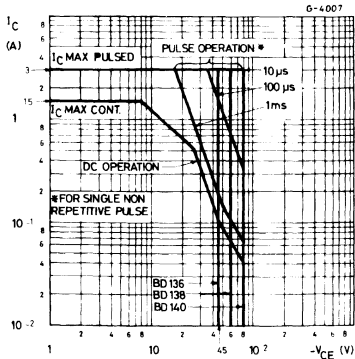

DC Current Gain.

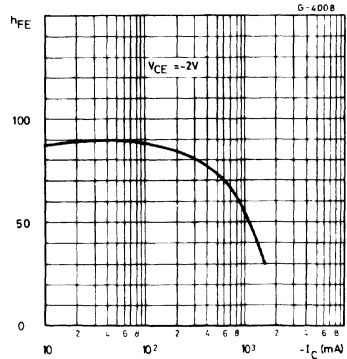

Collector-emitter Saturation Voltage.

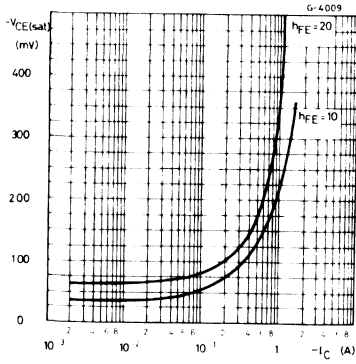

Base-emitter Voltage.

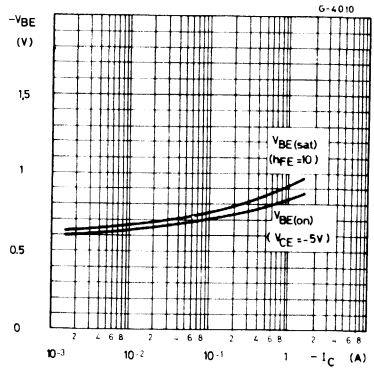

LOW POWER FAST SWITCHING

DESCRIPTION

The BD157, BD158 and BD159 are silicon epitaxial planar NPN transistors in TO-126 plastic package, intended for applications in low power linear and switching.

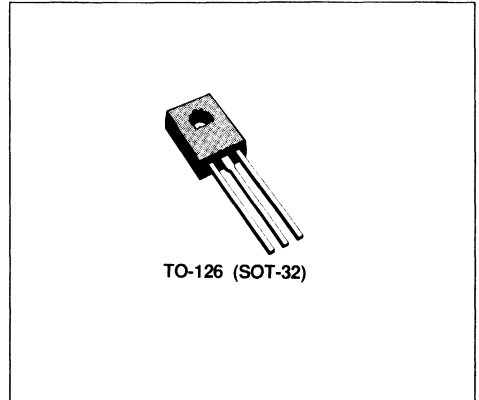

INTERNAL SCHEMATIC DIAGRAM

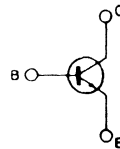

ABSOLUTE MAXIMUM RATINGS

Symbol	Parameter	Value			Unit
		BD157	BD158	BD159	
V_{CBO}	Collector-base Voltage ($I_E = 0$)	275	325	375	V
V_{CEO}	Collector-emitter Voltage ($I_B = 0$)	250	300	350	V
V_{EBO}	Emitter-base Voltage ($I_C = 0$)	5			V
I_C	Collector Current	0.5			A
I_{CM}	Collector Peak Current	1			A
I_B	Base Current	0.25			A
P_{Tot}	Total Power Dissipation at $T_{case} < 25\text{ }^\circ\text{C}$	20			W
T_{stg}	Storage Temperature	- 65 to 150			$^\circ\text{C}$
T_j	Junction Temperature	150			$^\circ\text{C}$

THERMAL DATA

$R_{th\ J-case}$	Thermal Resistance Junction-case	Max	6.25	°C/W
------------------	----------------------------------	-----	------	------

ELECTRICAL CHARACTERISTICS ($T_{case} = 25\text{ °C}$ unless otherwise specified)

Symbol	Parameter	Test Conditions	Min.	Typ.	Max.	Unit
I_{CBO}	Collector Cutoff Current ($I_E = 0$)	$V_{CB} = \text{rated } V_{CBO}$			100	μA
I_{EBO}	Emitter Cutoff Current ($I_C = 0$)	$V_{EB} = 5\text{ V}$			100	μA
V_{CE0}^*	Collector-emitter Voltage	$I_C = 1\text{ mA}$ for BD157 for BD158 for BD159	250 300 350			V V V
h_{FE}^*	DC Current Gain	$I_C = 50\text{ mA}$ $V_{CE} = 10\text{ V}$	30		240	

* Pulsed : pulse duration = 300 μs , duty cycle = 1.5 %.

MEDIUM POWER LINEAR AND SWITCHING APPLICATIONS

DESCRIPTION

The BD175, BD177 and BD179 are silicon epitaxial-base NPN power transistors in Jedec TO-126 plastic package intended for use in medium power linear and switching applications.

The complementary PNP types are the BD176, BD178 and BD180.

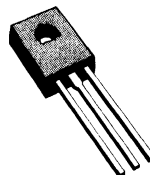

TO-126 (SOT-32)

INTERNAL SCHEMATIC DIAGRAMS

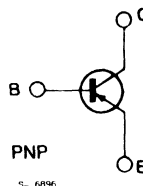
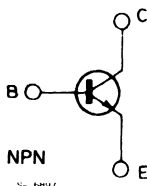

ABSOLUTE MAXIMUM RATINGS

Symbol	Parameter	NPN PNP*	Value			Unit
			BD175 BD176	BD177 BD178	BD179 BD180	
V_{CBO}	Collector-base Voltage ($I_E = 0$)		45	60	80	V
V_{CEO}	Collector-emitter Voltage ($I_B = 0$)		45	60	80	V
V_{EBO}	Emitter-base Voltage ($I_C = 0$)		5			V
I_C	Collector Current		3			A
I_{CM}	Collector Peak Current		7			A
P_{Tot}	Total Power Dissipation at $T_{case} \leq 25^\circ C$		30			W
T_{stg}	Storage Temperature		- 65 to 150			$^\circ C$
T_j	Junction Temperature		150			$^\circ C$

* For PNP types voltage and current values are negative.

THERMAL DATA

$R_{th\ j-case}$	Thermal Resistance Junction-case	Max	4.16	°C/W
------------------	----------------------------------	-----	------	------

ELECTRICAL CHARACTERISTICS ($T_{case} = 25\text{ °C}$ unless otherwise specified)

Symbol	Parameter	Test Conditions	Min.	Typ.	Max.	Unit
I_{CBO}	Collector Cutoff Current ($I_E = 0$)	for BD175/76 $V_{CB} = 45\text{ V}$ for BD177/78 $V_{CB} = 60\text{ V}$ for BD179/80 $V_{CB} = 80\text{ V}$			100 100 100	μA μA μA
I_{EBO}	Emitter Cutoff Current ($I_C = 0$)	$V_{EB} = 5\text{ V}$			1	mA
$V_{CE0(sus)}^*$	Collector-emitter Sustaining Voltage	$I_C = 100\text{ mA}$ for BD175/76 for BD177/78 for BD179/80	45 60 80			V V V
$V_{CE(sat)}^*$	Collector-emitter Saturation Voltage	$I_C = 1\text{ A}$ $I_B = 0.1\text{ A}$			0.8	V
V_{BE}^*	Base-emitter Voltage	$I_C = 1\text{ A}$ $V_{CE} = 2\text{ V}$			1.3	V
h_{FE}^*	DC Current Gain	$I_C = 150\text{ mA}$ $V_{CE} = 2\text{ V}$ $I_C = 1\text{ A}$ $V_{CE} = 2\text{ V}$	40 15			
h_{FE}	Groups** 6 10 16 (only BD175/6)	$I_C = 150\text{ mA}$ $V_{CE} = 2\text{ V}$	40 63 100		100 160 250	
f_T	Transition Frequency	$I_C = 250\text{ mA}$ $V_{CE} = 10\text{ V}$	3			MHz

* Pulsed : pulse duration = 300 μs , duty cycle $\leq 1.5\%$.

** Only on request.

For PNP types voltage and current values are negative.

Safe Operating Areas.

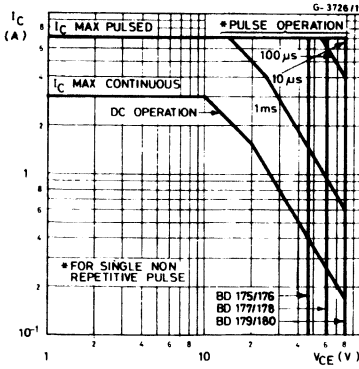

DC Current Gain (NPN types).

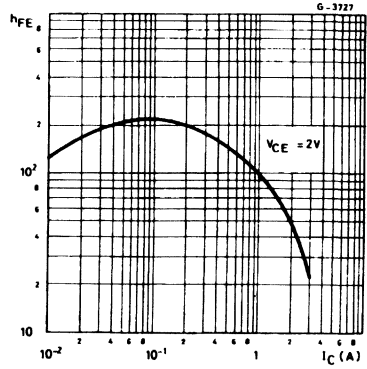

DC Current Gain (PNP types)

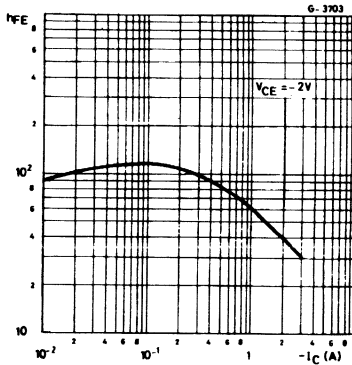

DC Transconductance (NPN types).

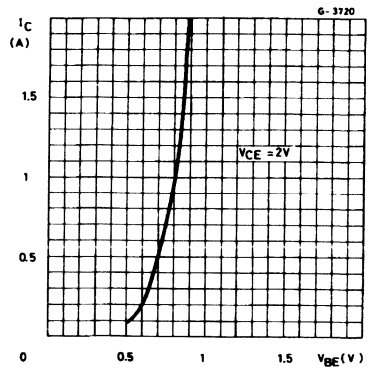

DC Transconductance (PNP types)

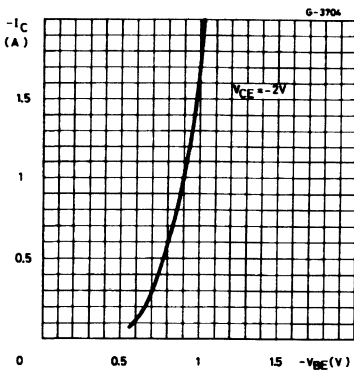

Collector-emitter Saturation Voltage (NPN types).

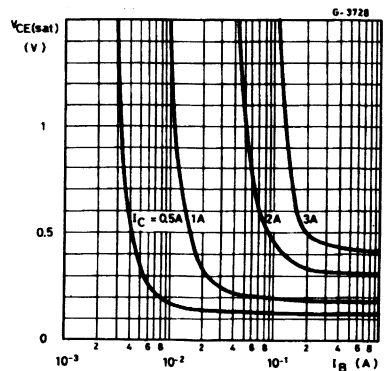

Collector-emitter Saturation Voltage (PNP types).

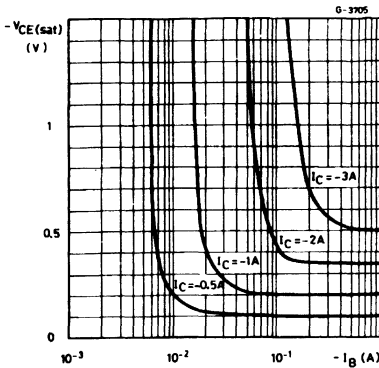

Collector-emitter Saturation Voltage (PNP types).

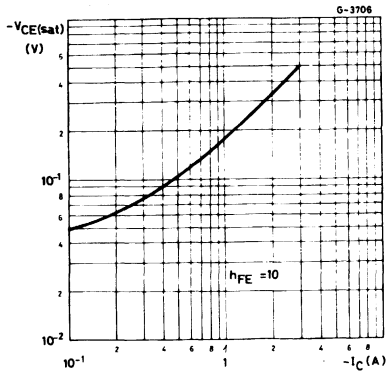

Base-emitter Saturation Voltage (PNP types).

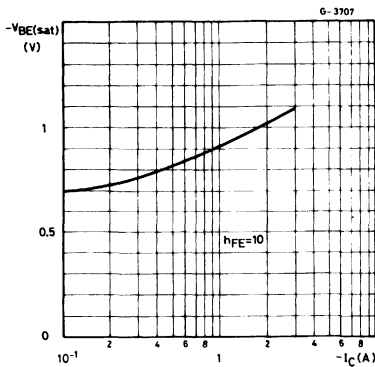

Collector-emitter Saturation Voltage (NPN types).

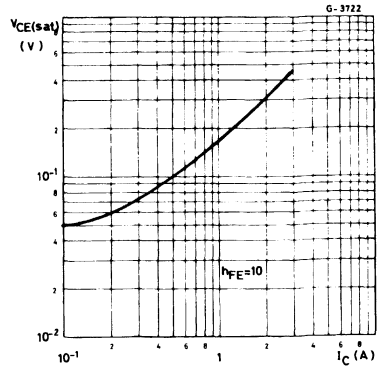

Base-emitter Saturation Voltage (NPN types).

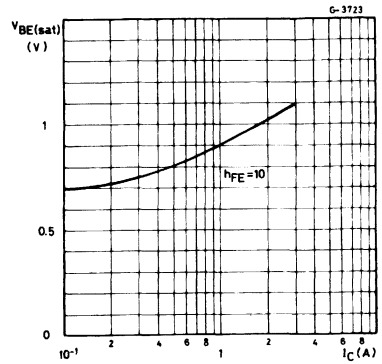

Saturated Switching Characteristics (NPN types).

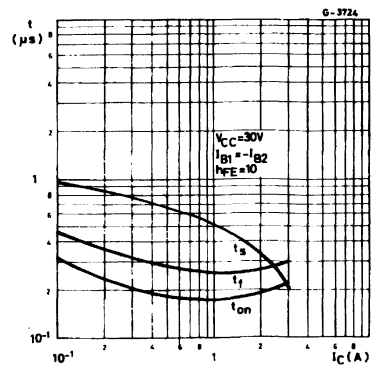

Saturated Switching Characteristics (PNP types).

Power Derating Chart.

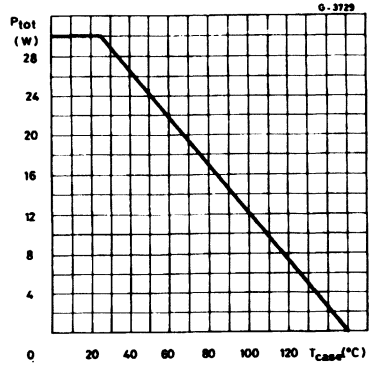
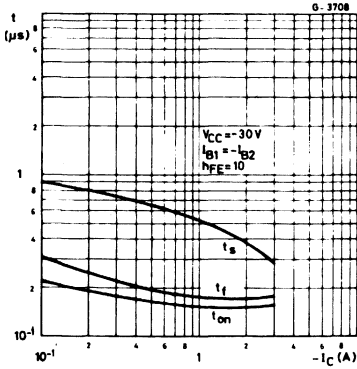

MEDIUM POWER LINEAR AND SWITCHING APPLICATIONS

DESCRIPTION

The BD233, BD235 and BD237 are silicon epitaxial-base NPN power transistors in Jedec TO-126 plastic package intended for use in medium power linear and switching applications.

The complementary PNP types are the BD234, BD236 and BD238 respectively.

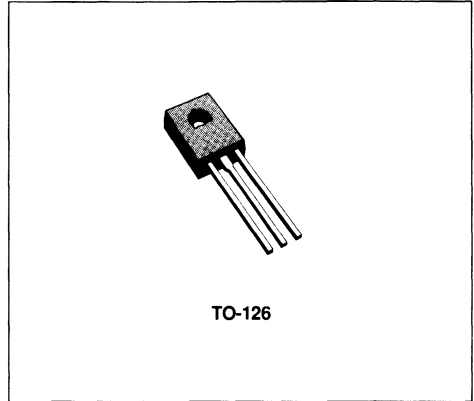

INTERNAL SCHEMATIC DIAGRAMS

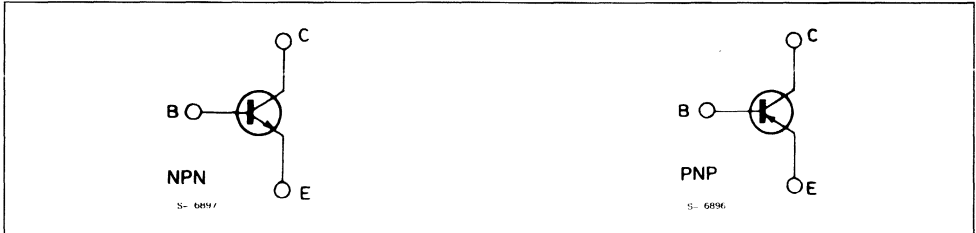

ABSOLUTE MAXIMUM RATINGS

Symbol	Parameter	NPN PNP*	Value			Unit
			BD233 BD234	BD235 BD236	BD237 BD238	
V_{CBO}	Collector-base Voltage ($I_E = 0$)		45	60	100	V
V_{CEO}	Collector-emitter Voltage ($I_B = 0$)		45	60	80	V
V_{CER}	Collector-emitter Voltage ($R_{BE} = 1\text{ K}\Omega$)		45	60	100	V
V_{EBO}	Emitter-base Voltage ($I_C = 0$)		5			V
I_C	Collector Current		2			A
I_{CM}	Collector Peak Current		6			A
P_{tot}	Total Power Dissipation at $T_{case} \leq 25\text{ }^\circ\text{C}$		25			W
T_{stg}	Storage Temperature		- 65 to 150			$^\circ\text{C}$
T_J	Junction Temperature		150			$^\circ\text{C}$

* For PNP types voltage and current values are negative.

THERMAL DATA

$R_{th\ j-case}$	Thermal Resistance Junction-case	Max	5	°C/W
------------------	----------------------------------	-----	---	------

ELECTRICAL CHARACTERISTICS ($T_{case} = 25\text{ °C}$ unless otherwise specified)

Symbol	Parameter	Test Conditions	Min.	Typ.	Max.	Unit
I_{CBO}	Collector Cutoff Current ($I_E = 0$)	for BD233/34 $V_{CB} = 45\text{ V}$ for BD235/36 $V_{CB} = 60\text{ V}$ for BD237/38 $V_{CB} = 100\text{ V}$ $T_{case} = 150\text{ °C}$ for BD233/34 $V_{CB} = 45\text{ V}$ for BD235/36 $V_{CB} = 60\text{ V}$ for BD237/38 $V_{CB} = 100\text{ V}$			100 100 100	μA μA μA
I_{EBO}	Emitter Cutoff Current ($I_C = 0$)	$V_{EB} = 5\text{ V}$			1	mA
$V_{CE(sus)}^*$	Collector-emitter Sustaining Voltage	$I_C = 100\text{ mA}$	for BD233/34 45 for BD235/36 60 for BD237/38 80			V V V
$V_{CE(sat)}^*$	Collector-emitter Saturation Voltage	$I_C = 1\text{ A}$	$I_B = 0.1\text{ A}$		0.6	V
V_{BE}^*	Base-emitter Voltage	$I_C = 1\text{ A}$	$V_{CE} = 2\text{ V}$		1.3	V
h_{FE}^*	DC Current Gain	$I_C = 150\text{ mA}$ $I_C = 1\text{ A}$	$V_{CE} = 2\text{ V}$ $V_{CE} = 2\text{ V}$	40 25		
f_T	Transition Frequency	$I_C = 250\text{ mA}$	$V_{CE} = 10\text{ V}$	3		MHz
h_{FE1}/h_{FE2}^*	Matched Pairs	$I_C = 150\text{ mA}$	$V_{CE} = 2\text{ V}$		1.6	

* Pulsed : pulse duration = 300 μs , duty cycle $\leq 1.5\%$.
For PNP types voltage and current values are negative.

Safe Operating Areas.

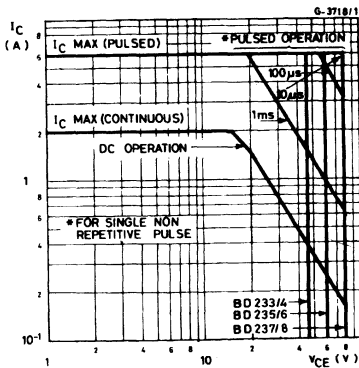

DC Current Gain (NPN types).

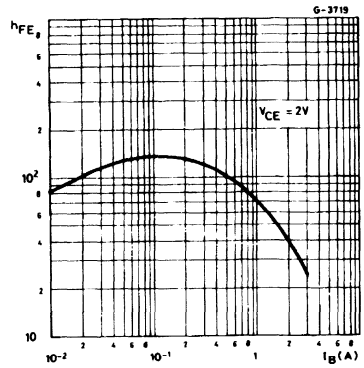

DC Current Gain (PNP types).

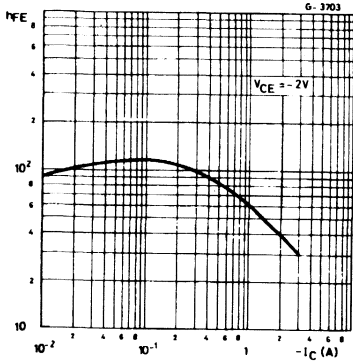

DC Transconductance (NPN types).

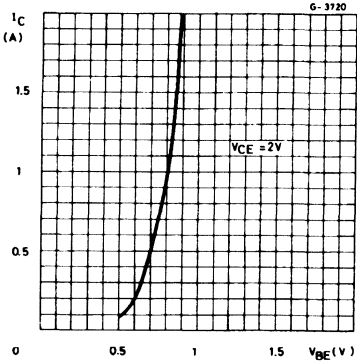

DC Transconductance (PNP types).

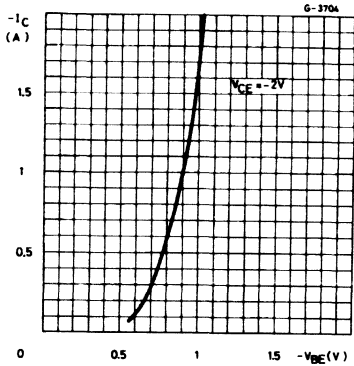

Collector-emitter Saturation Voltage (NPN types).

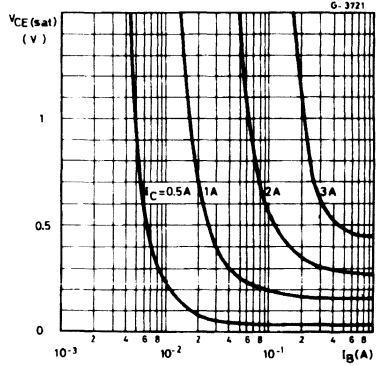

Collector-emitter Saturation Voltage (PNP types).

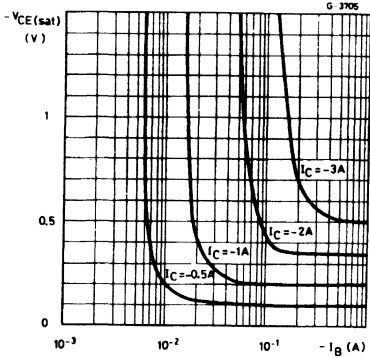

Collector-emitter Saturation Voltage (NPN types).

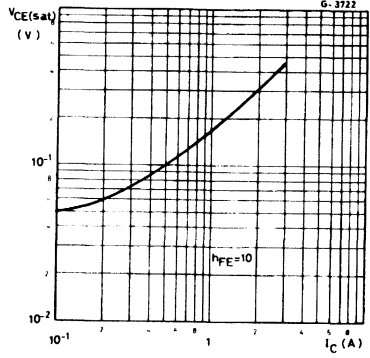

Collector-emitter Saturation Voltage (PNP types).

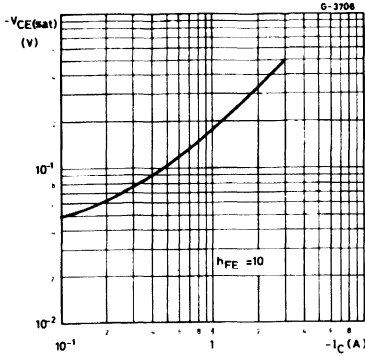

Base-emitter Saturation Voltage (NPN types).

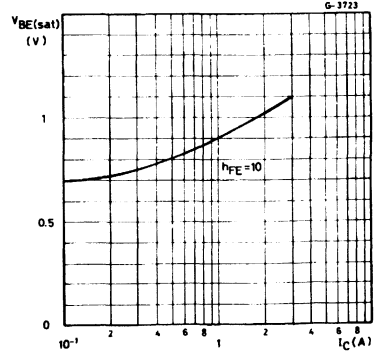

Base-emitter Saturation Voltage (NPN types).

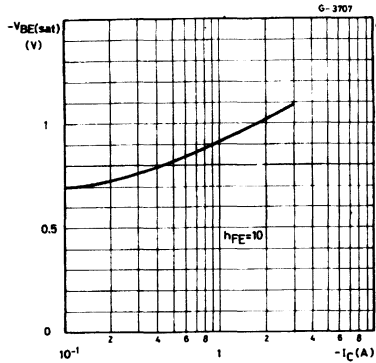

Saturated Switching Characteristics (NPN types).

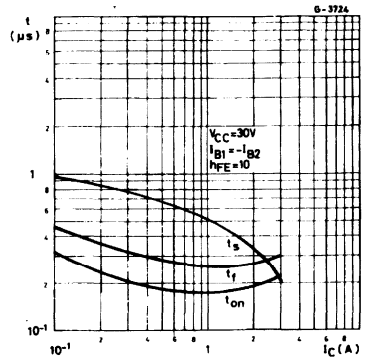

Saturated Switching Characteristics (PNP types).

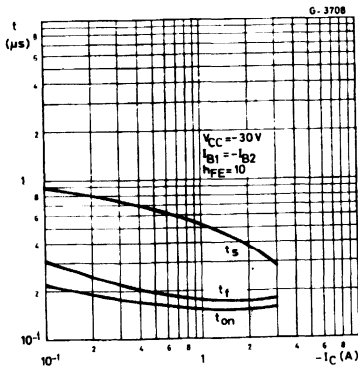

Power Derating Chart.

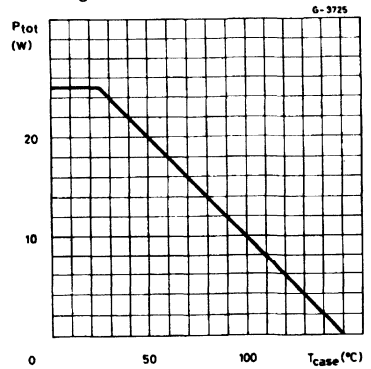

MEDIUM POWER LINEAR AND SWITCHING APPLICATIONS

DESCRIPTION

The BD239, BD239A, BD239B and BD239C are silicon epitaxial-base NPN power transistors in Jedec TO-220 plastic package, intended for use in medium power linear and switching applications.

The complementary PNP types are the BD240, BD240A, BD240B and BD240C respectively.

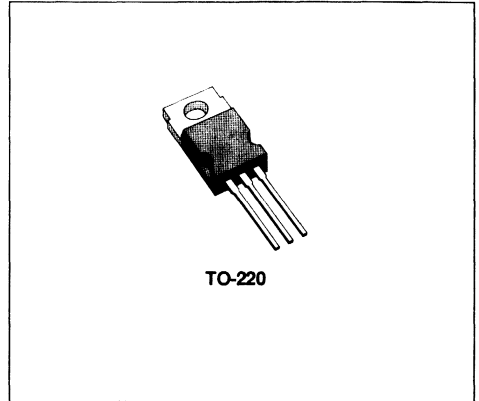

INTERNAL SCHEMATIC DIAGRAMS

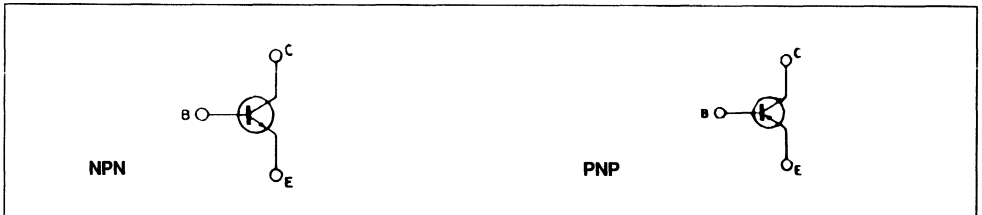

ABSOLUTE MAXIMUM RATINGS

Symbol	Parameter	NPN PNP*	Value				Unit
			BD239 BD240	BD239A BD240A	BD239B BD240B	BD239C BD240C	
V_{CEr}	Collector-emitter Voltage ($R_{BE} = 100 \Omega$)		55	70	90	115	V
V_{CE0}	Collector-emitter Voltage ($I_B = 0$)		45	60	80	100	V
V_{EBO}	Emitter-base Voltage ($I_C = 0$)		5				V
I_C	Collector Current		2				A
I_{CM}	Collector Peak Current		4				A
I_B	Base Current		0.6				A
P_{tot}	Total Power Dissipation at $T_{case} \leq 25^\circ C$ $T_{amb} \leq 25^\circ C$		30				W
			2				W
T_{stg}	Storage Temperature		- 65 to 150				$^\circ C$
T_j	Junction Temperature		150				$^\circ C$

* For PNP types voltage and current values are negative.

THERMAL DATA

$R_{th\ j-case}$	Thermal Resistance Junction-case	Max	4.17	°C/W
$R_{th\ j-amb}$	Thermal Resistance Junction-ambient	Max	62.5	°C/W

ELECTRICAL CHARACTERISTICS ($T_{case} = 25\text{ °C}$ unless otherwise specified)

Symbol	Parameter	Test Conditions	Min.	Typ.	Max.	Unit
I_{CEO}	Collector Cutoff Current ($I_B = 0$)	for BD239/40/39A/40A $V_{CE} = 30\text{ V}$ for BD239B/40B/39C/40C $V_{CE} = 60\text{ V}$			0.3	mA
I_{CES}	Collector Cutoff Current ($V_{BE} = 0$)	for BD239/40 $V_{CE} = 45\text{ V}$ for BD239A/40A $V_{CE} = 60\text{ V}$ for BD239B/40B $V_{CE} = 80\text{ V}$ for BD239C/40C $V_{CE} = 100\text{ V}$			0.2	mA
I_{EBO}	Emitter Cutoff Current ($I_C = 0$)	$V_{EB} = 5\text{ V}$			1	mA
$V_{CE(sus)}^*$	Collector-emitter Sustaining Voltage ($I_B = 0$)	$I_C = 30\text{ mA}$ for BD239/40 for BD239A/40A for BD239B/40B for BD239C/40C	45 60 80 100			V V V V
$V_{CE(sat)}^*$	Collector-emitter Saturation Voltage	$I_C = 1\text{ A}$ $I_B = 0.2\text{ mA}$			0.7	V
$V_{BE(on)}^*$	Base-emitter Voltage	$I_C = 1\text{ A}$ $V_{CE} = 4\text{ V}$			1.3	V
h_{FE}^*	DC Current Gain	$I_C = 0.2\text{ A}$ $V_{CE} = 4\text{ V}$ $I_C = 1\text{ A}$ $V_{CE} = 4\text{ V}$	40 15			
h_{fe}	Small Signal Current Gain	$I_C = 0.2\text{ A}$ $V_{CE} = 10\text{ V}$ $f = 1\text{ KHz}$ $I_C = 0.2\text{ A}$ $V_{CE} = 10\text{ V}$ $f = 1\text{ MHz}$	20 3			

* Pulsed : pulse duration = 300 μ s, duty cycle $\leq 2\%$.

Safe Operating Areas.

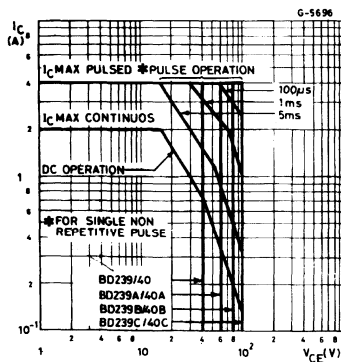

For the others characteristics curves see TIP31/TIP32 series.

MEDIUM POWER LINEAR AND SWITCHING APPLICATIONS

DESCRIPTION

The BD241, BD241A, BD241B and BD241C are silicon epitaxial-base NPN power transistors in Jedec TO-220 plastic package, intended for use in medium power linear and switching applications.

The complementary PNP types are the BD242, BD242A, BD242B and BD242C respectively.

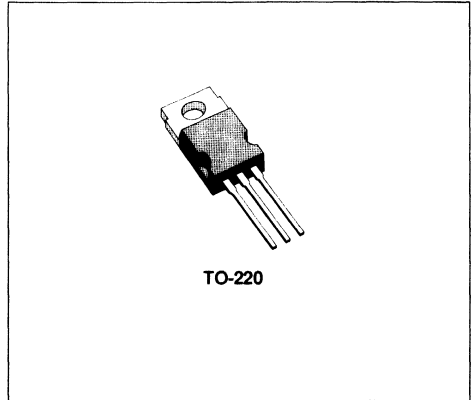

INTERNAL SCHEMATIC DIAGRAM

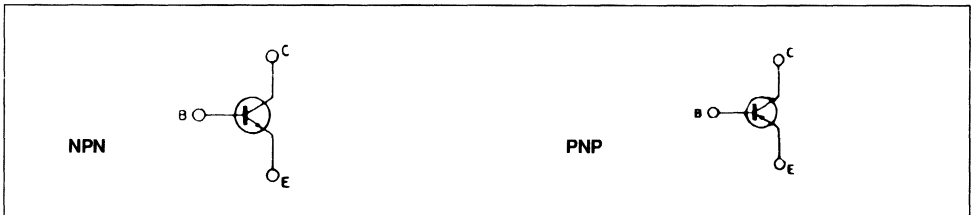

ABSOLUTE MAXIMUM RATINGS

Symbol	Parameter	NPN PNP*	Value				Unit
			BD241 BD242	BD241A BD242A	BD241B BD242B	BD241C BD242C	
V_{CEr}	Collector-emitter Voltage ($R_{BE} = 100 \Omega$)		55	70	90	115	V
V_{CEO}	Collector-emitter Voltage ($I_B = 0$)		45	60	80	100	V
V_{EBO}	Emitter-base Voltage ($I_C = 0$)		5				V
I_C	Collector Current		3				A
I_{CM}	Collector Peak Current		5				A
I_B	Base-Current		1				A
P_{Tot}	Total Power Dissipation at $T_{case} \leq 25^\circ C$ $T_{amb} \leq 25^\circ C$		40				W
T_{stg}	Storage Temperature		- 65 to 150				$^\circ C$
T_j	Junction Temperature		150				$^\circ C$

* For PNP types voltage and current values are negative.

THERMAL DATA

$R_{th\ j-case}$	Thermal Resistance Junction-case	Max	3.13	°C/W
$R_{th\ j-amb}$	Thermal Resistance Junction-ambient	Max	62.5	°C/W

ELECTRICAL CHARACTERISTICS ($T_{case} = 25\text{ °C}$ unless otherwise specified)

Symbol	Parameter	Test Conditions		Min.	Typ.	Max.	Unit
I_{CEO}	Collector Cutoff Current ($I_B = 0$)	for BD241/42/41A/42A $V_{CE} = 30\text{ V}$ for BD241B/42B/41C/42C $V_{CE} = 60\text{ V}$				0.3	mA
						0.3	mA
I_{CES}	Collector Cutoff Current ($V_{BE} = 0$)	for BD241/42	$V_{CE} = 45\text{ V}$			0.2	mA
		for BD241A/42A	$V_{CE} = 60\text{ V}$			0.2	mA
		for BD241B/42B	$V_{CE} = 80\text{ V}$			0.2	mA
		for BD241C/42C	$V_{CE} = 100\text{ V}$			0.2	mA
I_{EBO}	Emitter Cutoff Current ($I_C = 0$)	$V_{EB} = 5\text{ V}$				1	mA
$V_{CEO(sus)}^*$	Collector-emitter Sustaining Voltage ($I_B = 0$)	$I_C = 30\text{ mA}$	for BD241/42	45			V
			for BD241A/42A	60			V
			for BD241B/42B	80			V
			for BD241C/42C	100			V
$V_{CE(sat)}^*$	Collector-emitter Saturation Voltage	$I_C = 3\text{ A}$	$I_B = 0.6\text{ A}$			1.2	V
$V_{BE(on)}^*$	Base-emitter Voltage	$I_C = 3\text{ A}$	$V_{CE} = 4\text{ V}$			1.8	V
h_{FE}^*	DC Current Gain	$I_C = 1\text{ A}$	$V_{CE} = 4\text{ V}$	25			
		$I_C = 3\text{ A}$	$V_{CE} = 4\text{ V}$	10			
h_{fe}	Small Signal Current Gain	$I_C = 0.5\text{ A}$	$V_{CE} = 10\text{ V}$	20			
		$f = 1\text{ KHz}$					
		$I_C = 0.5\text{ A}$	$V_{CE} = 10\text{ V}$	3			
		$f = 1\text{ MHz}$					

* Pulsed : pulse duration = 300 μ s, duty cycle $\leq 2\%$.
For PNP types voltage and current values are negative.
For the characteristics curves see TIP31/TIP32 series.

POWER LINEAR AND SWITCHING APPLICATIONS

DESCRIPTION

The BD243, BD243A, BD243B and BD243C are silicon epitaxial-base NPN power transistors in Jedec TO-220 plastic package, intended for use in medium power linear and switching applications.

The complementary PNP types are the BD244, BD244A, BD244B and BD244C respectively.

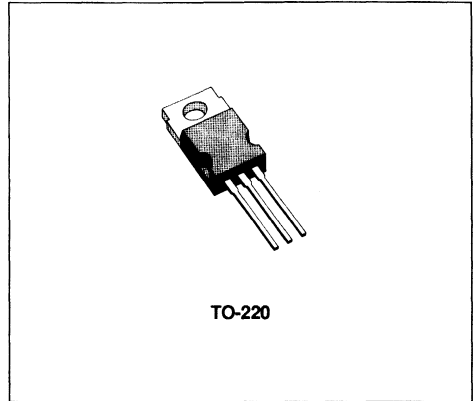

INTERNAL SCHEMATIC DIAGRAMS

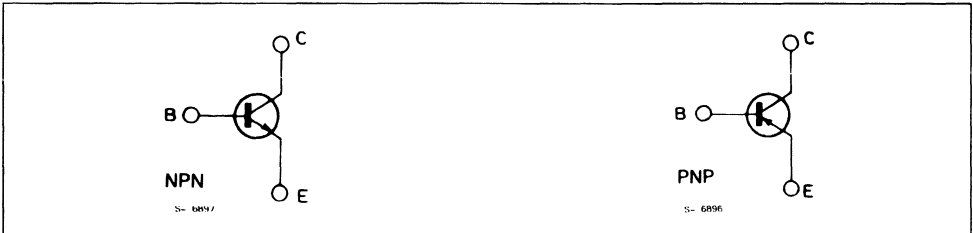

ABSOLUTE MAXIMUM RATINGS

Symbol	Parameter	NPN PNP*	Value				Unit
			BD243 BD244	BD243A BD244A	BD243B BD244B	BD243C BD244C	
V_{CBO}	Collector-base Voltage ($I_E = 0$)		45	60	80	100	V
V_{CEO}	Collector-emitter Voltage ($I_B = 0$)		45	60	80	100	V
V_{EBO}	Emitter-base Voltage ($I_C = 0$)		5				V
I_C	Collector Current		6				A
I_{CM}	Collector Peak Current		10				A
I_B	Base Current		2				A
P_{tot}	Total Power Dissipation at $T_{case} \leq 25^\circ C$		65				W
T_{stg}	Storage Temperature		- 65 to 150				$^\circ C$
T_j	Junction Temperature		150				$^\circ C$

* For PNP types voltage and current values are negative.

THERMAL DATA

$R_{th\ j-case}$	Thermal Resistance Junction-case	Max	1.92	°C/W
$R_{th\ j-amb}$	Thermal Resistance Junction-ambient	Max	62.5	°C/W

ELECTRICAL CHARACTERISTICS ($T_{case} = 25\text{ °C}$ unless otherwise specified)

Symbol	Parameter	Test Conditions	Min.	Typ.	Max.	Unit
I_{CEO}	Collector Cutoff Current ($I_B = 0$)	for BD243/44/43A/44A $V_{CE} = 30\text{ V}$ for BD243B/44B/43C/44C $V_{CE} = 60\text{ V}$			0.7	mA
I_{CES}	Collector Cutoff Current ($V_{BE} = 0$)	for BD243/44 $V_{CE} = 45\text{ V}$ for BD243A/44A $V_{CE} = 60\text{ V}$ for BD243B/44B $V_{CE} = 80\text{ V}$ for BD243C/44C $V_{CE} = 100\text{ V}$			0.4 0.4 0.4 0.4	mA mA mA mA
I_{EBO}	Emitter Cutoff Current ($I_C = 0$)	$V_{EB} = 5\text{ V}$			1	mA
$V_{CEO(sus)}^*$	Collector-emitter Sustaining Voltage ($I_B = 0$)	$I_C = 30\text{ mA}$ for BD243/44 for BD243A/44A for BD243B/44B for BD243C/44C	45 60 80 100			V V V V
$V_{CE(sat)}^*$	Collector-emitter Saturation Voltage	$I_C = 6\text{ A}$ $I_B = 1\text{ mA}$			1.5	V
V_{BE}^*	Base-emitter Voltage	$I_C = 6\text{ A}$ $V_{CE} = 4\text{ V}$			2	V
h_{FE}^*	DC Current Gain	$I_C = 0.3\text{ A}$ $V_{CE} = 4\text{ V}$ $I_C = 3\text{ A}$ $V_{CE} = 4\text{ V}$	30 15			
h_{fe}	Small Signal Current Gain	$I_C = 0.5\text{ A}$ $V_{CE} = 10\text{ V}$ $f = 1\text{ KHz}$ $I_C = 0.5\text{ A}$ $V_{CE} = 10\text{ V}$ $f = 1\text{ MHz}$	20 3			

* Pulsed : pulse duration = 300 μ s, duty cycle \leq 2%.

For PNP types voltage and current values are negative.

COMPLEMENTARY POWER DARLINGTONS

DESCRIPTION

The BD331, BD333, BD335 (NPN types) and BD332, BD334, BD336 (PNP types) are complementary epitaxial-base Darlingtonts in SOT-82 plastic package. They are intended for use in audio output stages, general amplifier and switching applications.

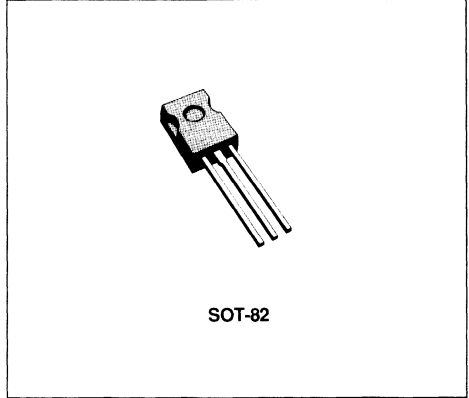

INTERNAL SCHEMATIC DIAGRAMS

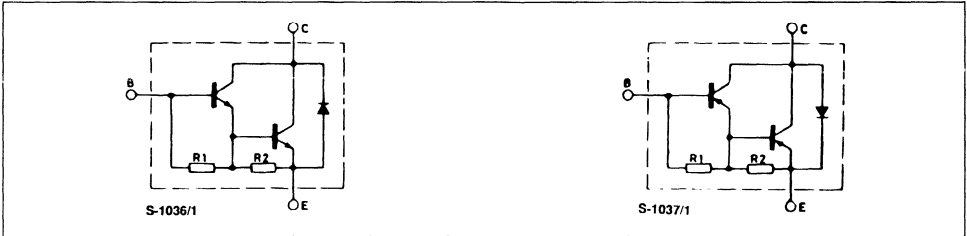

ABSOLUTE MAXIMUM RATINGS

Symbol	Parameter	NPN PNP	Value			Unit
			BD331 BD332	BD333 BD334	BD335 BD336	
V_{CBO}	Collector-base Voltage ($I_E = 0$)		60	80	100	V
V_{CEO}	Collector-emitter Voltage ($I_B = 0$)		60	80	100	V
V_{EBO}	Base-emitter Voltage ($I_C = 0$)		5			V
I_C	Collector Current		6			A
I_{CM}	Collector Peak Current ($t_p < 10$ ms)		10			A
I_B	Base Current		0.15			A
P_{Tot}	Total Power Dissipation at $T_{case} \leq 25$ °C		60			W
T_{stg}	Storage Temperature		- 65 to 150			°C
T_j	Junction Temperature		150			°C

For PNP types voltage and current values are negative.

THERMAL DATA

$R_{th(j-case)}$	Thermal Resistance Junction-case	Max	2.08	°C/W
------------------	----------------------------------	-----	------	------

ELECTRICAL CHARACTERISTICS ($T_{case} = 25\text{ °C}$ unless otherwise specified)

Symbol	Parameter	Test Conditions	Min.	Typ.	Max.	Unit
I_{CBO}	Collector Cutoff Current ($I_E = 0$)	$V_{CB} = \text{rated } V_{CBO}$ $T_{case} = 150\text{ °C}$			0.2 2	mA mA
I_{CEO}	Collector Cutoff Current ($I_B = 0$)	$V_{CE} = 1/2 V_{CEO\text{ max}}$			0.5	mA
I_{EBO}	Emitter Cutoff Current ($I_C = 0$)	$V_{EB} = 5\text{ V}$			5	mA
$V_{CE(sat)^*}$	Collector-emitter Saturation Voltage	$I_C = 3\text{ A}$ $I_B = 12\text{ mA}$			2	V
V_{BE}^*	Base-emitter Voltage	$I_C = 3\text{ A}$ $V_{CE} = 3\text{ V}$			2.5	V
h_{FE}^*	DC Current Gain	$I_C = 0.5\text{ A}$ $V_{CE} = 3\text{ V}$ for BD331, BD333, BD335 for BD332, BD334, BD336 $I_C = 3\text{ A}$ $V_{CE} = 3\text{ V}$ for BD331, BD333, BD335 for BD332, BD334, BD336 $I_C = 6\text{ A}$ $V_{CE} = 3\text{ V}$ for BD331, BD333, BD335 for BD332, BD334, BD336	750 750	1900 2700 3000 400		
V_F^*	Parallel Diode Forward Voltage	$I_F = 3\text{ A}$		1.8		V
h_{fe}	Small Signal Current Gain	$I_C = 3\text{ A}$ $V_{CE} = 3\text{ V}$ $f = 1\text{ MHz}$ for BD331, BD333, BD335 for BD332, BD334, BD336		50 150		
t_{on}	Turn-on Time	$I_C = 3\text{ A}$ $V_{CC} = 30\text{ V}$		1	2	μs
t_{off}	Turn-off Time	$I_{B1} = -I_{B2} = 12\text{ mA}$		5	10	μs

* Pulsed : pulse duration = 300 μs , duty cycle $\leq 1.5\%$.
For PNP types voltage and current values are negative.

Safe Operating Areas.

DC Current Gain (NPN types).

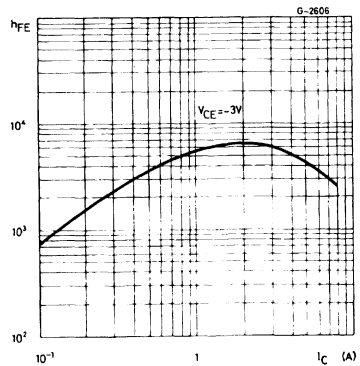
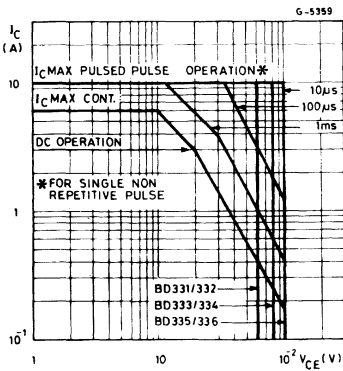

DC Current gain (PNP types).

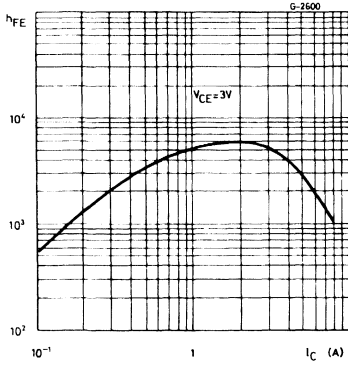

DC Transconductance (NPN types).

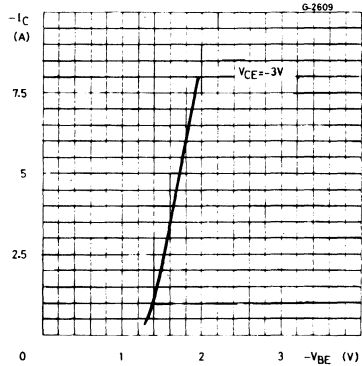

DC Transconductance (PNP types).

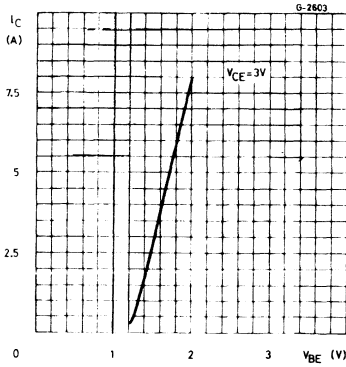

Collector-emitter Saturation Voltage (NPN types).

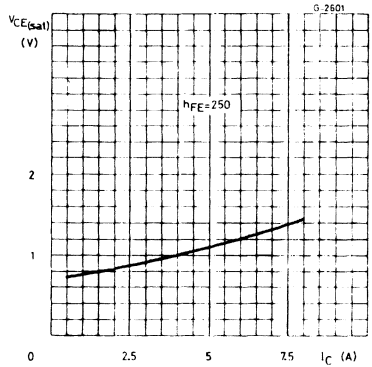

Collector-emitter Saturation Voltage (NPN types).

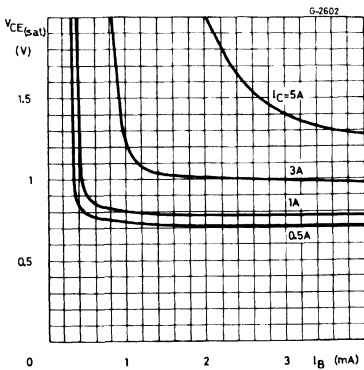

Collector-emitter Saturation Voltage (PNP types).

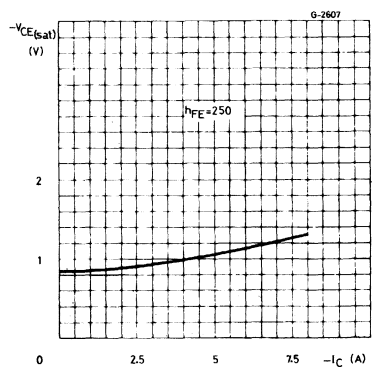

Collector-emitter Saturation Voltage (PNP types).

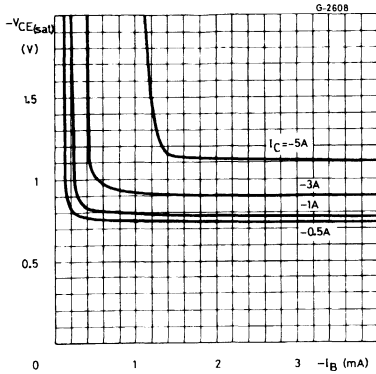

Small Signal Current Gain (NPN types).

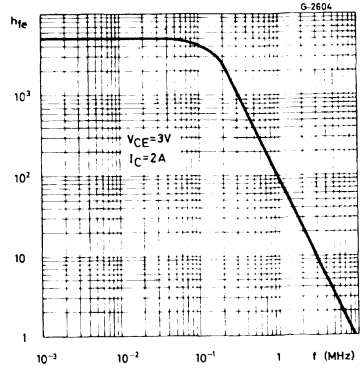

Small Signal Current Gain (PNP types).

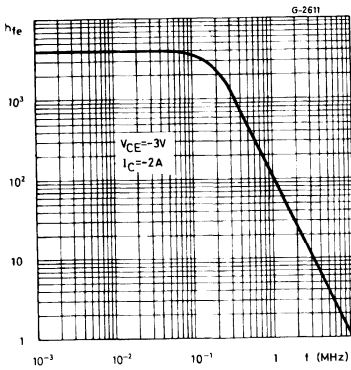

Saturated Switching Characteristics (NPN types).

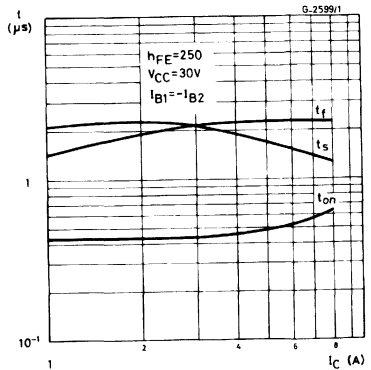

Saturated Switching Characteristics (PNP types).

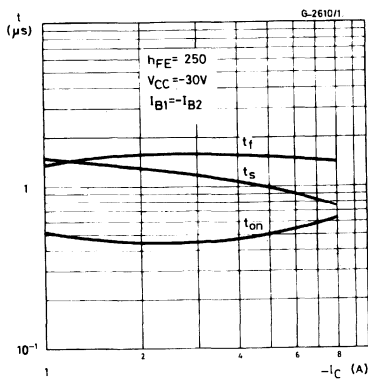

MEDIUM POWER LINEAR AND SWITCHING APPLICATION

DESCRIPTION

The BD433, BD435 and BD437 are silicon epitaxial-base NPN power transistors in Jedec TO-126 plastic package, intended for use in medium power linear and switching applications.

The BD433 is especially suitable for use in car-radio output stages.

The complementary PNP types are the BD434, BD436 and BD438 respectively.

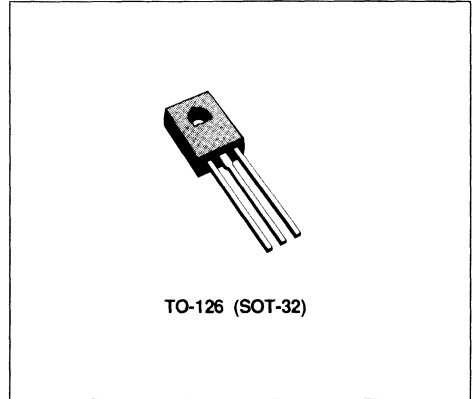

INTERNAL SCHEMATIC DIAGRAMS

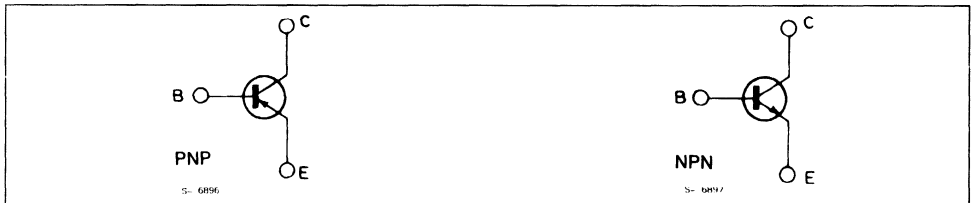

ABSOLUTE MAXIMUM RATINGS

Symbol	Parameter	NPN PNP*	Value			Unit
			BD433 BD434	BD435 BD436	BD437 BD438	
V_{CBO}	Collector-base Voltage ($I_E = 0$)		22	32	45	V
V_{CES}	Collector-emitter Voltage ($V_{BE} = 0$)		22	32	45	V
V_{CEO}	Collector-emitter Voltage ($I_B = 0$)		22	32	45	V
V_{EBO}	Emitter-base Voltage ($I_C = 0$)		5			V
I_C	Collector Current		4			A
I_{CM}	Collector Peak Current ($t \leq 10$ ms)		7			A
I_B	Base Current		1			A
P_{tot}	Total Power Dissipation at $T_{case} \leq 25$ °C		36			W
T_{stg}	Storage Temperature		- 65 to 150			°C
T_j	Junction Temperature		150			°C

* For PNP types voltage and current values are negative.

THERMAL DATA

$R_{th\ j-case}$	Thermal Resistance Junction-case	Max	3.5	°C/W
$R_{th\ j-amb}$	Thermal Resistance Junction-ambient	Max	100	°C/W

ELECTRICAL CHARACTERISTICS ($T_{case} = 25\text{ °C}$ unless otherwise specified)

Symbol	Parameter	Test Conditions		Min.	Typ.	Max.	Unit
I_{CBO}	Collector Cutoff Current ($I_E = 0$)	for BD433/34 for BD435/36 for BD437/38	$V_{CB} = 22\text{ V}$ $V_{CB} = 32\text{ V}$ $V_{CB} = 45\text{ V}$			100 100 100	μA μA μA
I_{CES}	Collector Cutoff Current ($V_{BE} = 0$)	for BD433/34 for BD435/36 for BD437/38	$V_{CE} = 22\text{ V}$ $V_{CE} = 32\text{ V}$ $V_{CE} = 45\text{ V}$			100 100 100	μA μA μA
I_{EBO}	Emitter Cutoff Current ($I_C = 0$)	$V_{EB} = 5\text{ V}$				1	mA
$V_{CEO(sus)}^*$	Collector-emitter Sustaining Voltage ($I_B = 0$)	$I_C = 100\text{ mA}$	for BD433/34 for BD435/36 for BD437/38	22 32 45			V V V
$V_{CE(sat)}^*$	Collector-emitter Saturation Voltage	$I_C = 2\text{ A}$	$I_B = 0.2\text{ A}$ for BD433/34 for BD435/36 for BD437/38		0.2 0.2 0.2	0.5 0.5 0.6	V V V
V_{BE}^*	Base-emitter Voltage	$I_C = 10\text{ mA}$ $I_C = 2\text{ A}$	$V_{CE} = 5\text{ V}$ $V_{CE} = 1\text{ V}$ for BD433/34 for BD435/36 for BD437/38		0.58	1.1 1.1 1.2	V V V
h_{FE}^*	DC Current Gain	$I_C = 10\text{ mA}$ $I_C = 500\text{ mA}$ $I_C = 2\text{ A}$	$V_{CE} = 5\text{ V}$ for BD433/34 for BD435/36 for BD437/38 $V_{CE} = 1\text{ V}$ $V_{CE} = 1\text{ V}$ for BD433/34 for BD435/36 for BD437/38	40 40 30 85 50 50 40	130 130 130 140		
h_{FE1}/h_{FE2}^*	Matched Pair	$I_C = 500\text{ mA}$	$V_{CE} = 1\text{ V}$			1.4	
f_T	Transition Frequency	$I_C = 250\text{ mA}$	$V_{CE} = 1\text{ V}$	3			MHz

* Pulsed : pulse duration = 300 μs , duty cycle = 1.5%.
For PNP types voltage and current values are negative.

Safe Operating Areas.

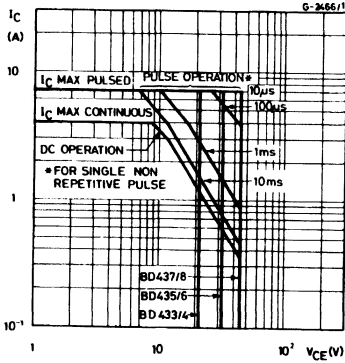

DC Current Gain (NPN types).

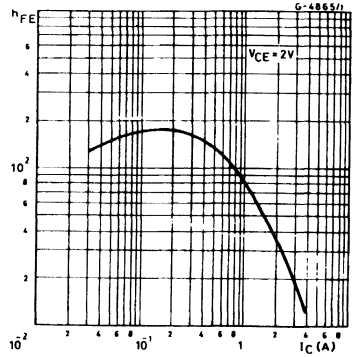

DC Current gain (PNP types).

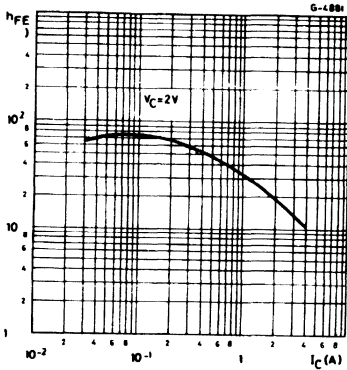

DC Transconductance (NPN types).

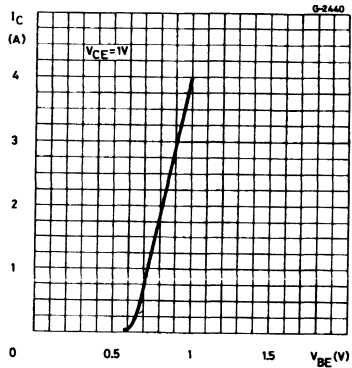

DC Transconductance (PNP types).

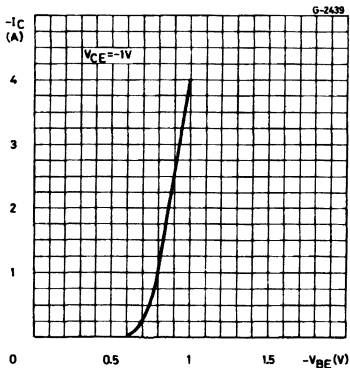

Collector-emitter Saturation Voltage (NPN types).

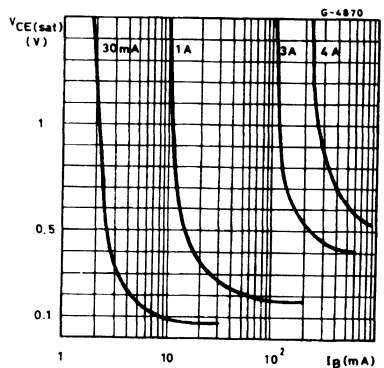

Collector-emitter Saturation Voltage (PNP types).

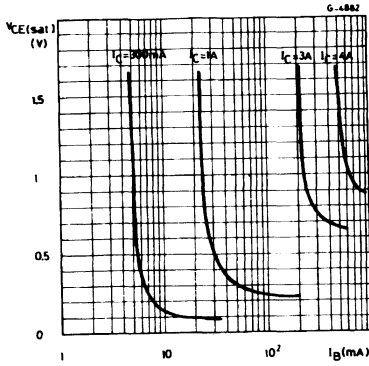

Saturated Switching Characteristics (NPN types).

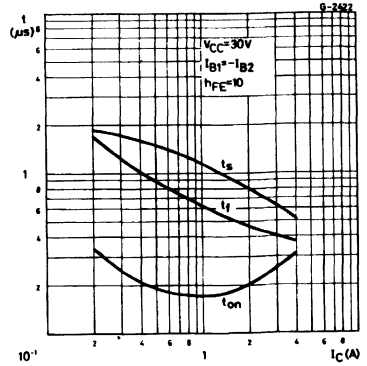

Saturated Switching Characteristics (PNP types).

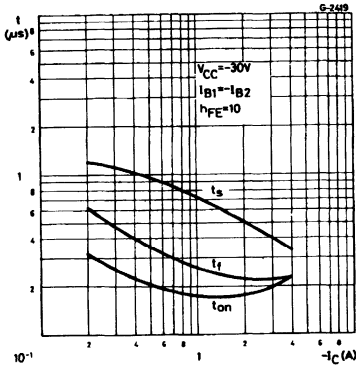

Collector-base Capacitance (NPN types).

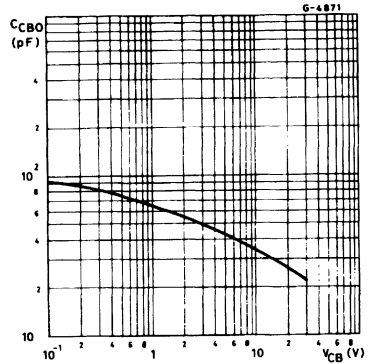

Collector-base Capacitance (PNP types).

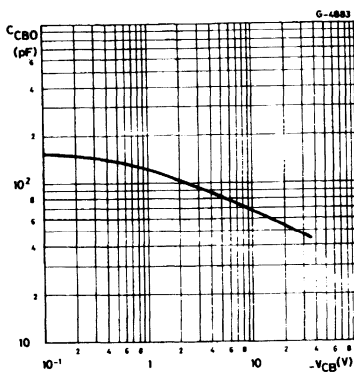

Transition Frequency (NPN types).

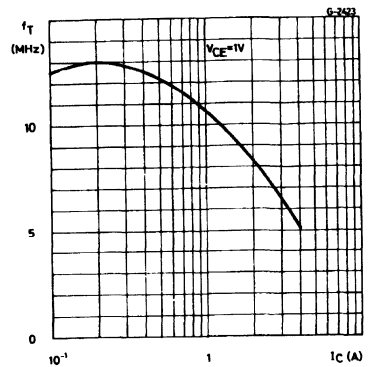

Transition Frequency (PNP types).

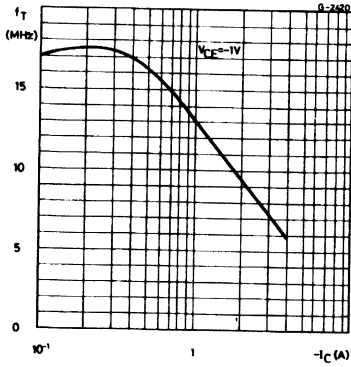

Power Rating Chart.

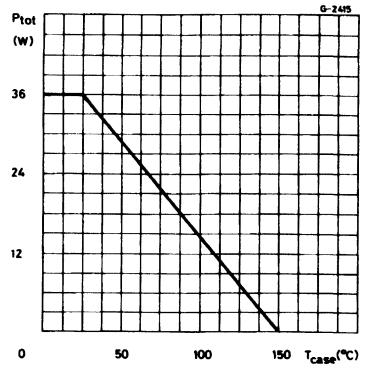

MEDIUM POWER LINEAR AND SWITCHING APPLICATIONS

DESCRIPTION

The BD439 and BD441 are silicon epitaxial-base NPN power transistors in Jedec TO-126 plastic package, intended for use in power linear and switching applications.

The complementary PNP types are the BD440 and BD442 respectively.

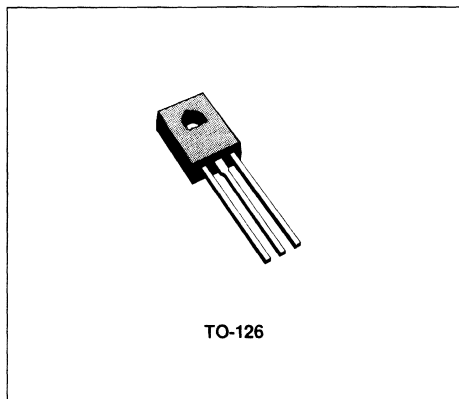

INTERNAL SCHEMATIC DIAGRAMS

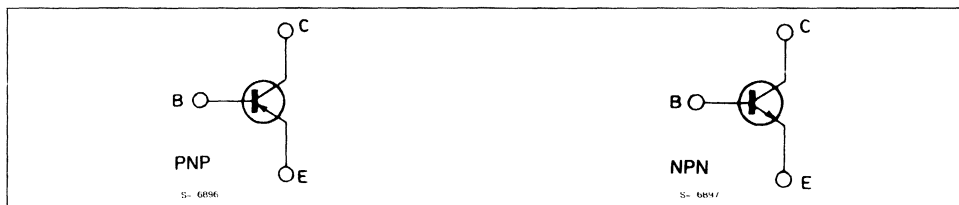

ABSOLUTE MAXIMUM RATINGS

Symbol	Parameter	NPN PNP*	Value		Unit
			BD439 BD440	BD441 BD442	
V_{CBO}	Collector-base Voltage ($I_E = 0$)		60	80	V
V_{CES}	Collector-emitter Voltage ($V_{BE} = 0$)		60	80	V
V_{CEO}	Collector-emitter Voltage ($I_B = 0$)		60	80	V
V_{EBO}	Emitter-base Voltage ($I_C = 0$)		5		V
I_C	Collector Current		4		A
I_{CM}	Collector Peak Current ($t \leq 10$ ms)		7		A
I_B	Base Current		1		A
P_{tot}	Total Power Dissipation at $T_{case} \leq 25$ °C		36		W
T_{stg}	Storage Temperature		- 65 to 150		°C
T_j	Junction Temperature		150		°C

* For PNP types voltage and current values are negative.

THERMAL DATA

$R_{th\ j-case}$	Thermal Resistance Junction-case	Max	3.5	°C/W
$R_{th\ j-amb}$	Thermal Resistance Junction-ambient	Max	100	°C/W

ELECTRICAL CHARACTERISTICS ($T_{case} = 25\text{ °C}$ unless otherwise specified)

Symbol	Parameter	Test Conditions		Min.	Typ.	Max.	Unit
I_{CBO}	Collector Cutoff Current ($I_E = 0$)	for BD439/40	$V_{CB} = 60\text{ V}$			100	μA
		for BD441/42	$V_{CB} = 80\text{ V}$			100	μA
I_{CES}	Collector Cutoff Current ($V_{BE} = 0$)	for BD439/40	$V_{CE} = 60\text{ V}$			100	μA
		for BD441/42	$V_{CE} = 80\text{ V}$			100	μA
I_{EBO}	Emitter Cutoff Current ($I_C = 0$)	$V_{EB} = 5\text{ V}$				1	mA
$V_{CEO(sus)}^*$	Collector-emitter Sustaining Voltage ($I_B = 0$)	$I_C = 100\text{ mA}$	for BD439/40	60			V
			for BD441/42	80			V
$V_{CE(sat)}^*$	Collector-emitter Saturation Voltage	$I_C = 2\text{ A}$	$I_B = 0.2\text{ A}$			0.8	V
V_{BE}^*	Base-emitter Voltage	$I_C = 10\text{ mA}$	$V_{CE} = 5\text{ V}$		0.58		V
		$I_C = 2\text{ A}$	$V_{CE} = 1\text{ V}$			1.5	V
h_{FE}^*	DC current Gain	$I_C = 10\text{ mA}$	$V_{CE} = 5\text{ V}$				
			for BD439/40	20	130		
			for BD441/42	15	130		
		$I_C = 500\text{ mA}$	$V_{CE} = 1\text{ V}$				
			for BD439/40	40	140		
			for BD441/42	40	140		
		$I_C = 2\text{ A}$	$V_{CE} = 1\text{ V}$				
			for BD439/40	25			
			for BD441/42	15			
h_{FE1}/h_{FE2}^*	Matched Pair	$I_C = 500\text{ mA}$	$V_{CE} = 1\text{ V}$			1.4	
f_T	Transition Frequency	$I_C = 250\text{ mA}$	$V_{CE} = 1\text{ V}$	3			MHz

* Pulsed : pulse duration = 300 μs , duty cycle $\leq 1.5\%$.
 For PNP types voltage and current values are negative.

Safe Operating Areas.

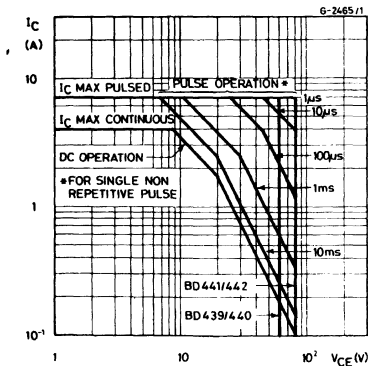

For the others characteristics curve see the BD433/BD434 series.

EPITAXIAL-BASE NPN/PNP

DESCRIPTION

The BD533, BD535 and BD537 are silicon epitaxial-base NPN power transistors in Jedec TO-220 plastic package, intended for use in medium power linear and switching applications.

The complementary PNP types are the BD534, BD536 and BD538 respectively.

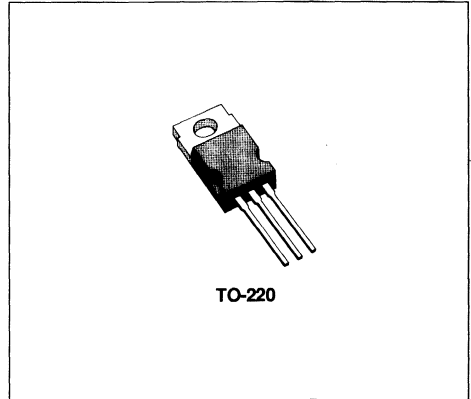

INTERNAL SCHEMATIC DIAGRAMS

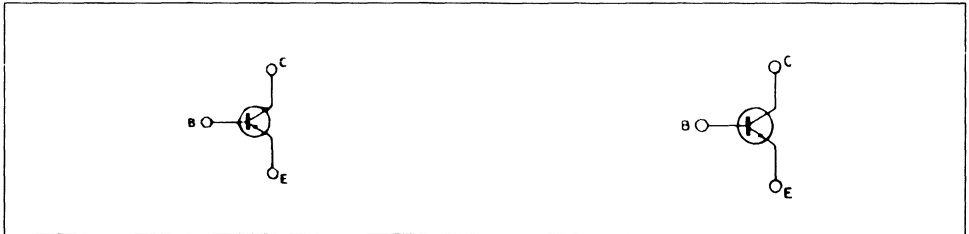

ABSOLUTE MAXIMUM RATINGS

Symbol	Parameter	NPN PNP*	Value			Unit
			BD533 BD534	BD535 BD536	BD537 BD538	
V_{CBO}	Collector-base Voltage ($I_E = 0$)		45	60	80	V
V_{CES}	Collector-emitter Voltage ($V_{BE} = 0$)		45	60	80	V
V_{CEO}	Collector-emitter Voltage ($I_B = 0$)		45	60	80	V
V_{EBO}	Emitter-base Voltage ($I_C = 0$)		5			V
I_C, I_E	Collector and Emitter Current		8			A
I_B	Base Current		1			A
P_{tot}	Total Power Dissipation at $T_{case} \leq 25^\circ\text{C}$		50			W
T_{stg}	Storage Temperature		- 65 to 150			$^\circ\text{C}$
T_j	Junction Temperature		150			$^\circ\text{C}$

* For PNP types voltage and current values are negative.

THERMAL DATA

$R_{th\ j-case}$	Thermal Resistance Junction-case	Max	2.5	°C/W
$R_{th\ j-amb}$	Thermal Resistance Junction-ambient	Max	70	°C/W

ELECTRICAL CHARACTERISTICS ($T_{case} = 25\text{ °C}$ unless otherwise specified)

Symbol	Parameter	Test Conditions		Min.	Typ.	Max.	Unit
I_{CBO}	Collector Cutoff Current ($I_E = 0$)	for BD533/34 for BD535/36 for BD537/38	$V_{CB} = 45\text{ V}$ $V_{CB} = 60\text{ V}$ $V_{CB} = 80\text{ V}$			100 100 100	μA μA μA
I_{CES}	Collector Cutoff Current ($V_{BE} = 0$)	for BD533/34 for BD535/36 for BD537/38	$V_{CE} = 45\text{ V}$ $V_{CE} = 60\text{ V}$ $V_{CE} = 80\text{ V}$			100 100 100	μA μA μA
I_{EBO}	Emitter Cutoff Current ($I_C = 0$)	$V_{EB} = 5\text{ V}$				1	mA
$V_{CEO(sus)}^*$	Collector-emitter Sustaining Voltage ($I_B = 0$)	$I_C = 100\text{ mA}$	for BD533/34 for BD535/36 for BD537/38	45 60 80			V V V
$V_{CE(sat)}^*$	Collector-emitter Saturation Voltage	$I_C = 2\text{ A}$ $I_C = 6\text{ A}$	$I_B = 0.2\text{ A}$ $I_B = 0.6\text{ A}$		0.8	0.8	V V
V_{BE}^*	Base-emitter Voltage	$I_C = 2\text{ A}$	$V_{CE} = 2\text{ V}$			1.5	V
h_{FE}^*	DC Current Gain	$I_C = 10\text{ mA}$ $I_C = 500\text{ mA}$ $I_C = 2\text{ A}$	$V_{CE} = 5\text{ V}$ for BD533/34 for BD535/36 for BD537/38 $V_{CE} = 2\text{ V}$ $V_{CE} = 2\text{ V}$ for BD533/34 for BD535/36 for BD537/38	20 20 15 40 25 25 15			
f_T	Transition Frequency	$I_C = 500\text{ mA}$	$V_{CE} = 1\text{ V}$	3	12		MHz
h_{FE} groups** :	J K	$I_C = 2\text{ A}$ $I_C = 3\text{ A}$ $I_C = 2\text{ A}$ $I_C = 3\text{ A}$	$V_{CE} = 2\text{ V}$ $V_{CE} = 2\text{ V}$ $V_{CE} = 2\text{ V}$ $V_{CE} = 2\text{ V}$	30 15 40 20		75 100	

* Pulsed : pulse duration = 300 μs , duty cycle = 1.5 %.

For PNP types voltage and current values are negative.

Safe Operating Areas.

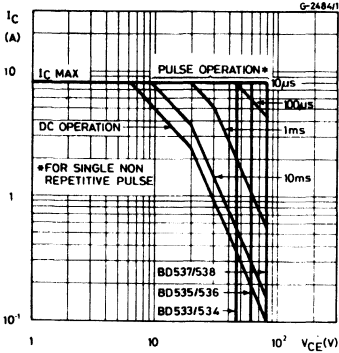

DC Current Gain (NPN types).

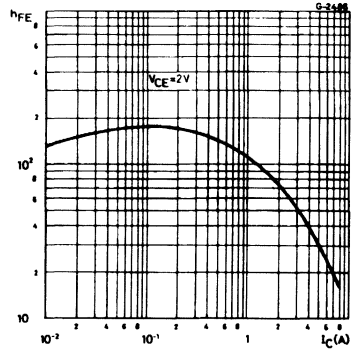

DC Current Gain (PNP types).

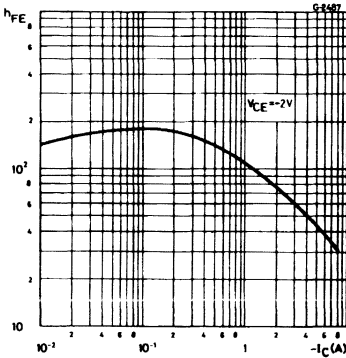

Collector-emitter Saturation Voltage (NPN types).

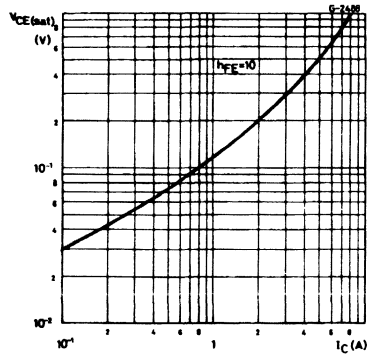

Collector-emitter Saturation Voltage (PNP types).

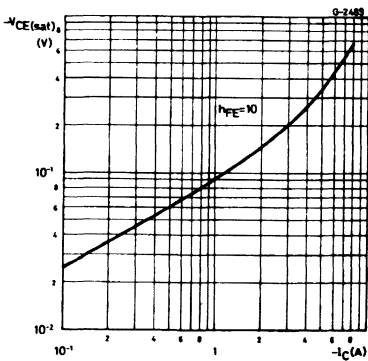

Base-emitter Saturation Voltage (NPN types).

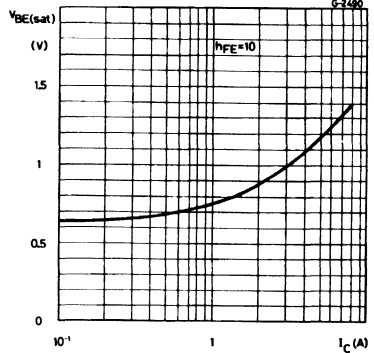

Base-emitter Saturation Voltage (PNP types).

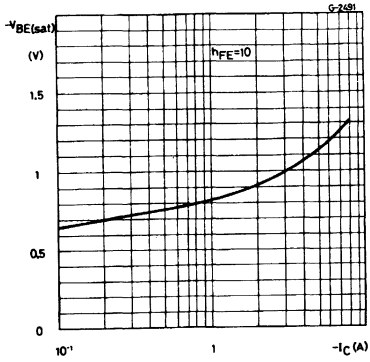

MEDIUM POWER DARLINGTONS

DESCRIPTION

The BD675, BD675A, BD677, BD677A, BD679, BD679A and BD681 are silicon epitaxial-base NPN power transistors in monolithic Darlington configuration and are mounted in Jedec TO-126 plastic package. They are intended for use in medium power linear and switching applications.

The complementary PNP types are the BD676, BD676A, BD678, BD678A, BD680, BD680A and BD682 respectively.

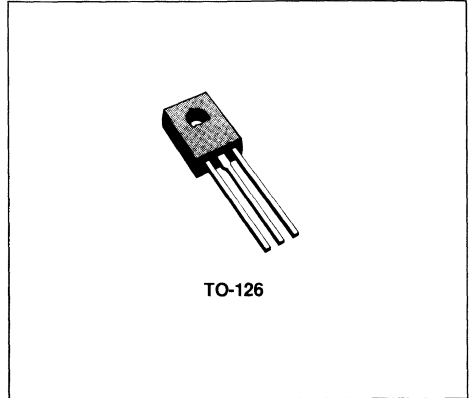

INTERNAL SCHEMATIC DIAGRAMS

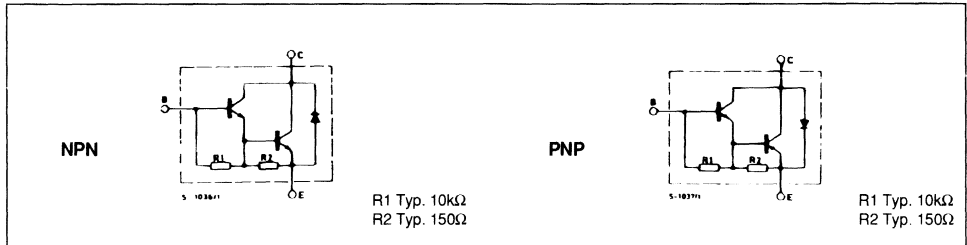

ABSOLUTE MAXIMUM RATINGS

Symbol	Parameter	NPN PNP*	Value				Unit
			BD675/A BD676A	BD677/A BD677A	BD679/A BD680A	BD681 BD682	
V_{CE0}	Collector-emitter Voltage ($I_E = 0$)		45	60	80	100	V
V_{CE0}	Collector-emitter Voltage ($I_B = 0$)		45	60	80	100	V
V_{EBO}	Emitter-base Voltage ($I_C = 0$)		5				V
I_C	Collector Current		4				A
I_{CM}	Collector Peak Current (repetitive)		6				A
I_B	Base Current		100				mA
P_{tot}	Total Power Dissipation at $T_{case} \leq 25^\circ\text{C}$		40				W
T_{stg}	Storage Temperature		- 65 to 150				$^\circ\text{C}$
T_j	Junction Temperature		150				$^\circ\text{C}$

For PNP types voltage and current values are negative.

THERMAL DATA

$R_{th\ j-case}$	Thermal Resistance Junction-case	Max	3.12	°C/W
$R_{th\ j-amb}$	Thermal Resistance Junction-ambient	Max	100	°C/W

ELECTRICAL CHARACTERISTICS ($T_{case} = 25^{\circ}C$ unless otherwise specified)

Symbol	Parameter	Test Conditions	Min.	Typ.	Max.	Unit
I_{CBO}	Collector Cutoff Current ($I_E = 0$)	$V_{CB} = \text{rated } V_{CBO}$			200	μA
		$V_{CB} = \text{rated } V_{CBO}$ $T_{case} = 100^{\circ}C$			2	mA
I_{CEO}	Collector Cutoff Current ($I_B = 0$)	$V_{CE} = \text{half rated } V_{CEO}$			500	μA
I_{EBO}	Emitter Cutoff Current ($I_C = 0$)	$V_{EB} = 5V$			2	mA
$V_{CEO(sus)}^*$	Collector-emitter Sustaining Voltage ($I_B = 0$)	$I_C = 50mA$ for BD675/75A/76/76A for BD677/77A/78/78A for BD679/79A/80/80A for BD681/82	45 60 80 100			V V V V
$V_{CE(sat)}^*$	Collector-emitter Saturation Voltage	for BD675/76/77/78/79/80/81/82 $I_C = 1.5A$ $I_B = 30mA$			2.5	V
		for BD675A/76A/77A/78A/79A/80A $I_C = 2A$ $I_B = 40mA$			2.8	V
V_{BE}^*	Base-emitter Voltage	for 675/76/77/78/79/80/81/82 $I_C = 1.5A$ $V_{CE} = 3V$			2.5	V
		for 675A/76A/77A/78A/79A/80A $I_C = 2A$ $V_{CE} = 3V$			2.5	V
h_{FE}^*	DC current Gain	for 675/76/77/78/79/80/81/82 $I_C = 1.5A$ $V_{CE} = 3V$	750			
		for 675A/76A/77A/78A/79A/80A $I_C = 2A$ $V_{CE} = 3V$	750			
h_{fe}	Small Signal Current Gain	$I_C = 1.5A$ $V_{CE} = 3V$ $f = 1MHz$	1			

* Pulsed ; pulse duration = 300

Safe Operating Areas.

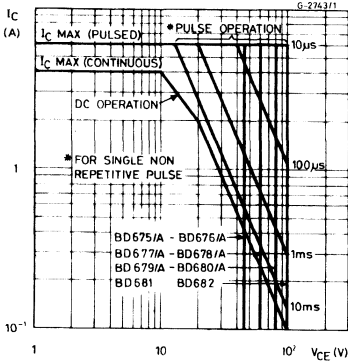

DC Current Gain.

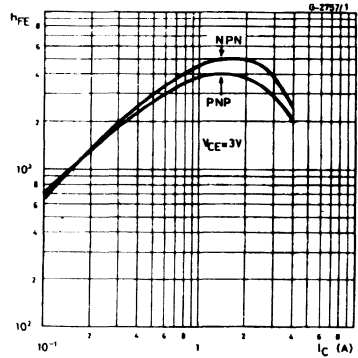

DC Transconductance.

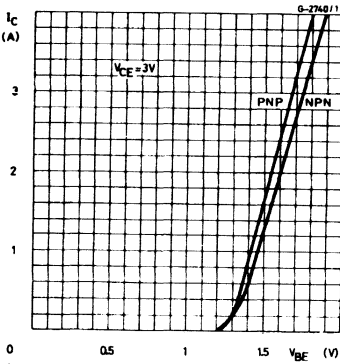

Collector-emitter Saturation Voltage.

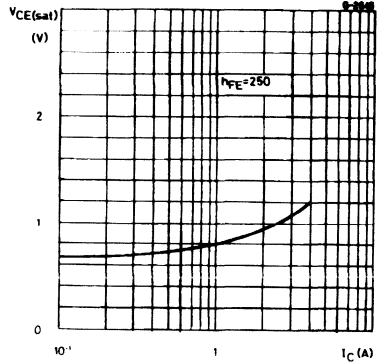

Small Signal Current gain.

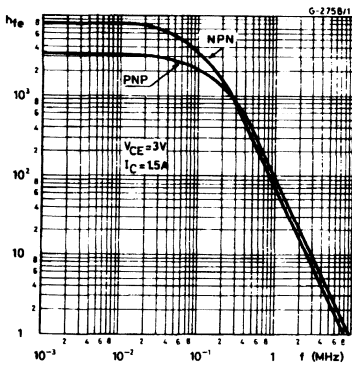

Collector-emitter Saturation Voltage (NPN types).

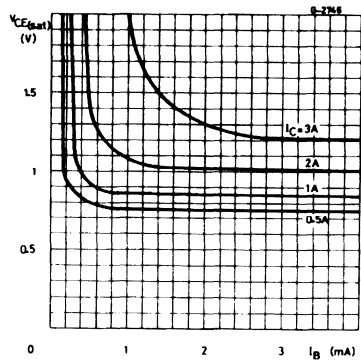

Collector-emitter Saturation Voltage (PNP).

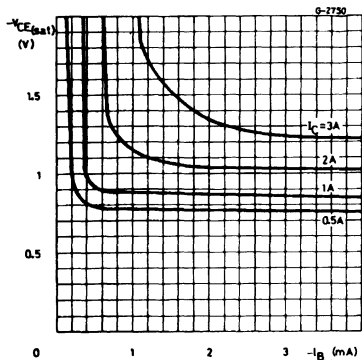

saturated Switching Characteristics (PNP).

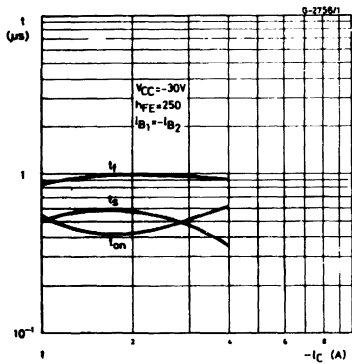

Saturated Switching Characteristics (NPN).

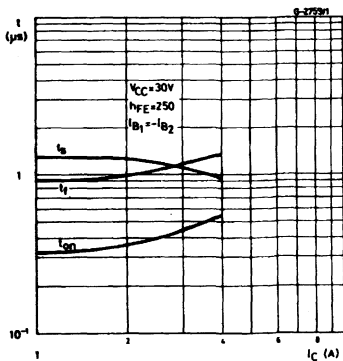

POWER LINEAR AND SWITCHING APPLICATIONS

DESCRIPTION

The BD705, BD707, BD709 and BD711 are silicon epitaxial-base NPN power transistors in Jedec TO-220 plastic package intended for use in power linear and switching applications. The complementary PNP types are the BD706, BD708, BD710 and BD712 respectively.

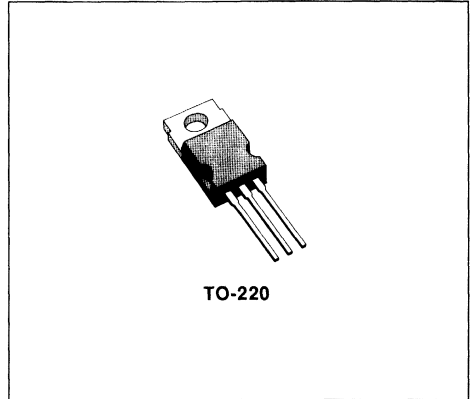

INTERNAL SCHEMATIC DIAGRAMS

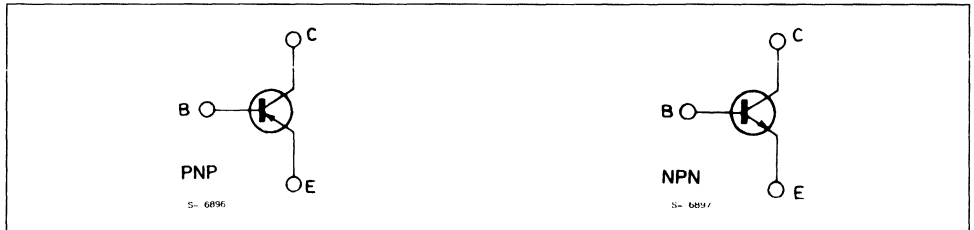

ABSOLUTE MAXIMUM RATINGS

Symbol	Parameter	NPN PNP*	Value				Unit
			BD705 BD706	BD707 BD708	BD709 BD710	BD711 BD712	
V_{CE0}	Collector-emitter Voltage ($I_E = 0$)		45	60	80	100	V
V_{CES}	Collector-emitter Voltage ($V_{BE} = 0$)		45	60	80	100	V
V_{CEO}	Collector-emitter Voltage ($I_B = 0$)		45	60	80	100	V
V_{EBO}	Emitter-base Voltage ($I_C = 0$)		5				V
I_C	Collector Current		12				A
I_B	Base Current		5				A
P_{tot}	Total Power Dissipation at $T_{case} \leq 25^\circ\text{C}$		75				W
T_{stg}	Storage Temperature		- 65 to 150				$^\circ\text{C}$
T_j	Junction Temperature		150				$^\circ\text{C}$

* For PNP types voltage and current values are negative.

THERMAL DATA

R _{th j-case}	Thermal Resistance Junction-case	Max	1.67	°C/W
R _{th j-amb}	Thermal Resistance Junction-ambient	Max	70	°C/W

ELECTRICAL CHARACTERISTICS (T_{case} = 25 °C unless otherwise specified)

Symbol	Parameter	Test Conditions	Min.	Typ.	Max.	Unit	
I _{CBO}	Collector Cutoff Current (I _E = 0)	for BD705/706 V _{CB} = 45 V			100	µA	
		for BD707/708 V _{CB} = 60 V			100	µA	
		for BD709/710 V _{CB} = 80 V			100	µA	
		for BD711/712 V _{CB} = 100 V			100	µA	
		T _{case} = 150 °C					
I _{CEO}	Collector Cutoff Current (I _B = 0)	for BD705/706 V _{CE} = 22 V			1	mA	
		for BD707/708 V _{CE} = 30 V			1	mA	
		for BD709/710 V _{CE} = 40 V			1	mA	
		for BD711/712 V _{CE} = 50 V			1	mA	
I _{EBO}	Emitter Cutoff Current (I _C = 0)	V _{EB} = 5 V			1	mA	
V _{CEO(sus)*}	Collector-emitter Sustaining Voltage (I _B = 0)	I _C = 100 mA	for BD705/706 for BD707/708 for BD709/710 for BD711/712	45 60 80 100		V V V V	
V _{CE(sat)*}	Collector-emitter Saturation Voltage	I _C = 4 A	I _B = 0.4 A		1	V	
V _{CEK*}	Knee Voltage	I _C = 3 A	I _B = **		0.4	V	
V _{BE*}	Base-emitter Voltage	I _C = 4 A	V _{CE} = 4 V		1.5	V	
h _{FE*}	DC Current Gain	I _C = 0.5 A	V _{CE} = 2 V	for BD705/706	40	120	400
				for BD707/708			
				for BD709/710			
		I _C = 2 A	V _{CE} = 2 V	for BD705/706	30	30	150
				for BD707/708			
				for BD709/710			
		I _C = 4 A	V _{CE} = 4 V	for BD705/706	20	30	150
				for BD707/708			
				for BD709/710			
		I _C = 10 A	V _{CE} = 4 V	for BD705/706	5	10	150
for BD707/708							
for BD709/710							
I _C = 10 A	V _{CE} = 4 V	for BD705/706	5	10	8		
		for BD707/708					
		for BD709/710					
I _C = 10 A	V _{CE} = 4 V	for BD705/706	5	10	8		
		for BD707/708					
		for BD709/710					
f _T	Transition Frequency	I _C = 300 mA	V _{CE} = 3 V	3		MHz	

* Pulsed : pulse duration = 300 µs, duty cycle = 1.5 %.

** Value for which I_C = 3.3A at V_{CE} = 2V.

For PNP types voltage and current values are negative.

Safe Operating Areas.

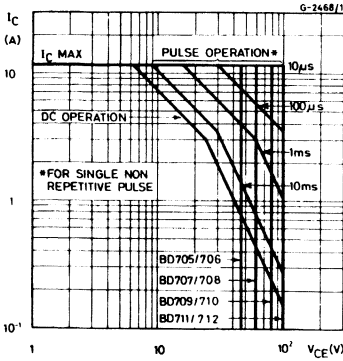

DC Current Gain (NPN types).

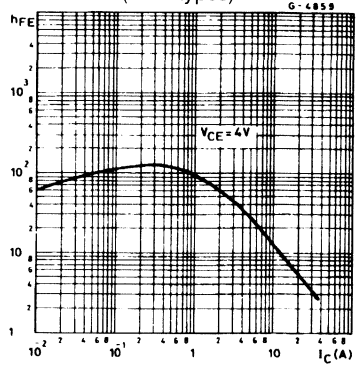

DC Current Gain (PNP types).

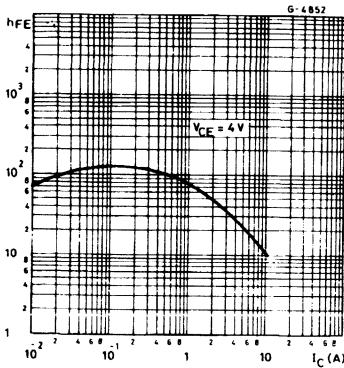

DC Transconductance (NPN types).

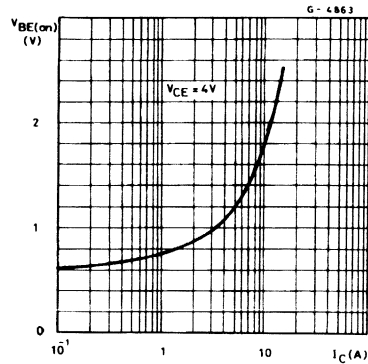

DC Transconductance (PNP types).

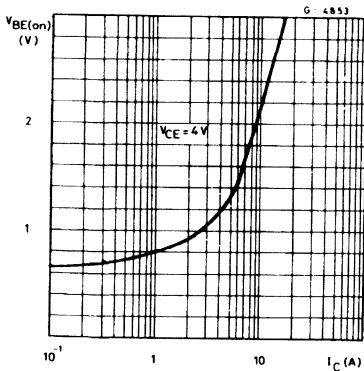

Collector-emitter Saturation Voltage (NPN types).

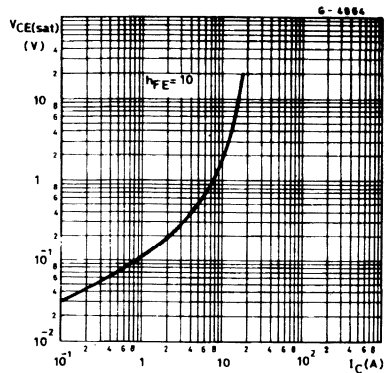

Collector-emitter Saturation Voltage (PNP types).

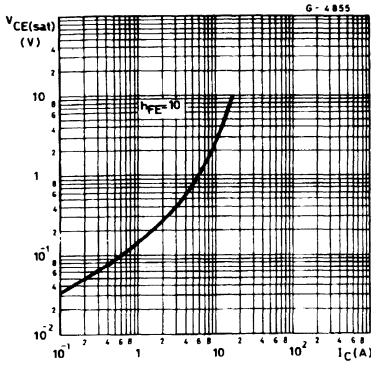

Saturated Switching Characteristics (NPN types).

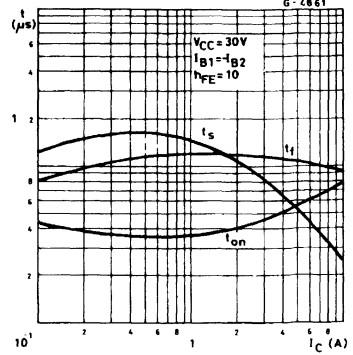

Saturated Switching Characteristics (PNP types).

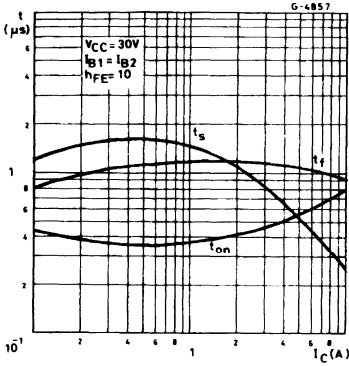

Collector-base Capacitance (NPN types).

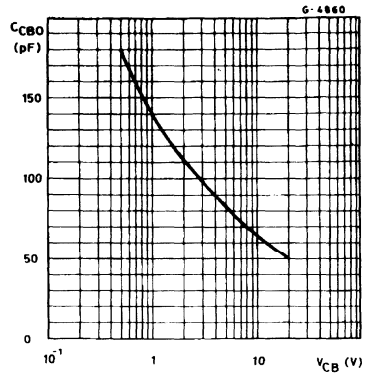

Collector-base Capacitance (PNP types).

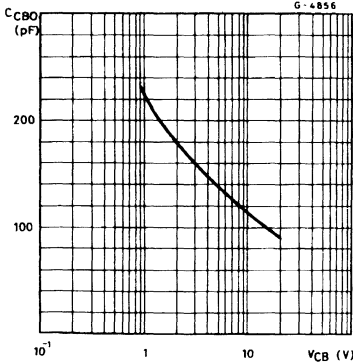

Transition Frequency (NPN types).

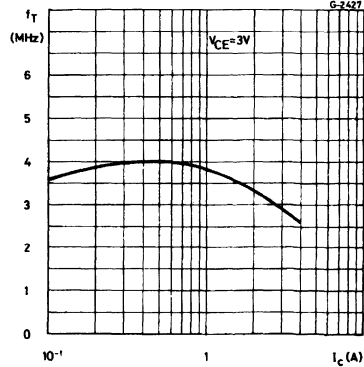

Transition Frequency (PNP types).

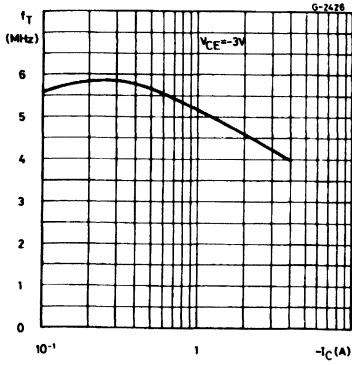

POWER LINEAR AND SWITCHING APPLICATIONS

DESCRIPTION

The BD905, BD907, BD909, BD911 are silicon epitaxial-base NPN power transistors in Jedec TO-220 plastic package. They are intended for use in power linear and switching applications.

The complementary PNP types are the BD906, BD908, BD910 and BD912 respectively.

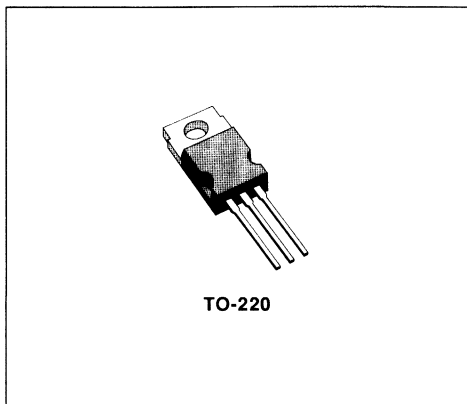

INTERNAL SCHEMATIC DIAGRAMS

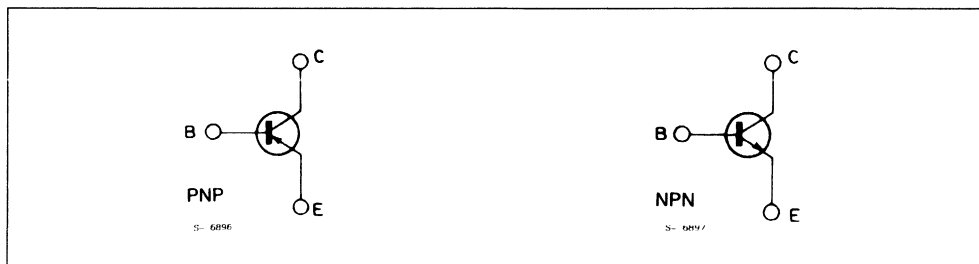

ABSOLUTE MAXIMUM RATINGS

Symbol	Parameter	NPN PNP*	Value				Unit
			BD905 BD906	BD907 BD908	BD909 BD910	BD911 BD912	
V_{CBO}	Collector-emitter Voltage ($I_E = 0$)		45	60	80	100	V
V_{CEO}	Collector-emitter Voltage ($I_B = 0$)		45	60	80	100	V
V_{EBO}	Emitter-base Voltage ($I_C = 0$)		5				V
I_E, I_C	Emitter and Collector Current		15				A
I_B	Base Current		5				A
P_{tot}	Total Power Dissipation at $T_{case} \leq 25^\circ C$		90				W
T_{stg}	Storage Temperature		- 65 to 150				$^\circ C$
T_J	Junction Temperature		150				$^\circ C$

* For PNP types voltage and current values are negative.

THERMAL DATA

$R_{th j-case}$	Thermal Resistance Junction-case	Max	1.4	°C/W
-----------------	----------------------------------	-----	-----	------

ELECTRICAL CHARACTERISTICS ($T_{case} = 25\text{ °C}$ unless otherwise specified)

Symbol	Parameter	Test Conditions	Min.	Typ.	Max.	Unit	
I_{CBO}	Collector Cutoff Current ($I_E = 0$)	for BD905/906 $V_{CB} = 45\text{ V}$			500	μA	
		for BD907/908 $V_{CB} = 60\text{ V}$			500	μA	
		for BD909/910 $V_{CB} = 80\text{ V}$			500	μA	
		for BD911/912 $V_{CB} = 100\text{ V}$			500	μA	
		$T_{case} = 150\text{ °C}$					
		for BD905/906 $V_{CB} = 45\text{ V}$			5	mA	
		for BD907/908 $V_{CB} = 60\text{ V}$			5	mA	
I_{CEO}	Collector Cutoff Current ($I_B = 0$)	for BD905/906 $V_{CE} = 30\text{ V}$			1	mA	
		for BD907/908 $V_{CE} = 30\text{ V}$			1	mA	
		for BD909/910 $V_{CE} = 40\text{ V}$			1	mA	
I_{EBO}	Emitter Cutoff Current ($I_C = 0$)	for BD911/912 $V_{CE} = 50\text{ V}$			1	mA	
		$V_{EB} = 5\text{ V}$			1	mA	
$V_{CEO(sus)*}$	Collector-emitter Sustaining Voltage ($I_B = 0$)	$I_C = 100\text{ mA}$ for BD905/906	45			V	
		for BD907/908	60			V	
		for BD909/910	80			V	
		for BD911/912	100			V	
$V_{CE(sat)*}$	Collector-emitter Saturation Voltage	$I_C = 5\text{ A}$			1	V	
		$I_C = 10\text{ A}$	$I_B = 0.5\text{ A}$ $I_B = 2.5\text{ A}$		3	V	
$V_{BE(sat)*}$	Base-emitter Saturation Voltage	$I_C = 10\text{ A}$	$I_B = 2.5\text{ A}$		2.5	V	
V_{BE*}	Base-emitter Voltage	$I_C = 5\text{ A}$	$V_{CE} = 4\text{ V}$		1.5	V	
h_{FE*}	DC Current Gain	$I_C = 0.5\text{ A}$	$V_{CE} = 4\text{ V}$	40	250		
		$I_C = 5\text{ A}$	$V_{CE} = 4\text{ V}$	15	150		
		$I_C = 10\text{ A}$	$V_{CE} = 4\text{ V}$	5			
f_T	Transition Frequency	$I_C = 0.5\text{ A}$	$V_{CE} = 4\text{ V}$	3		MHz	

* Pulsed : pulse duration = 300 μs , duty cycle = 1.5 %.
For PNP types voltage and current values are negative.

Safe Operating Areas.

DC Current Gain (NPN types).

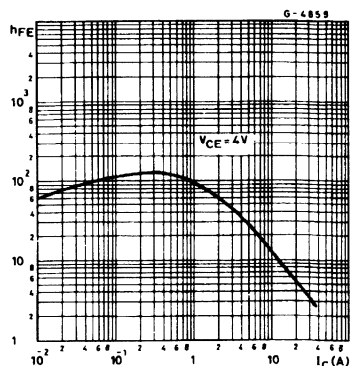
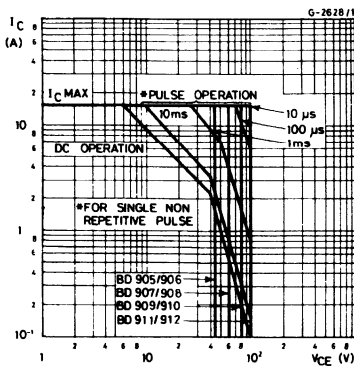

DC Current Gain (PNP types).

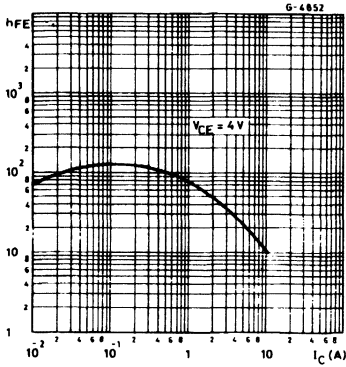

DC Transconductance (NPN types).

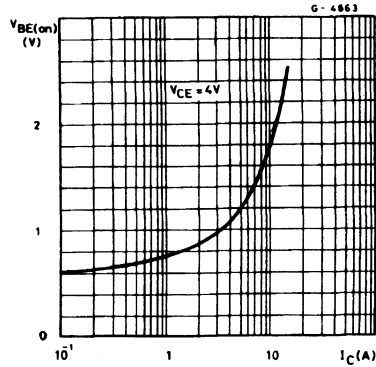

DC Transconductance (PNP types).

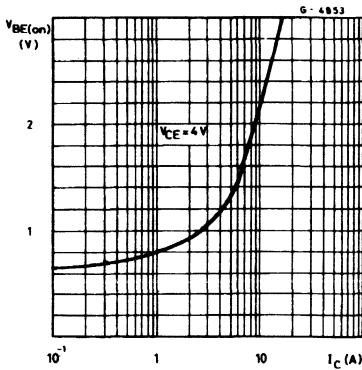

Collector-emitter Saturation Voltage (NPN types).

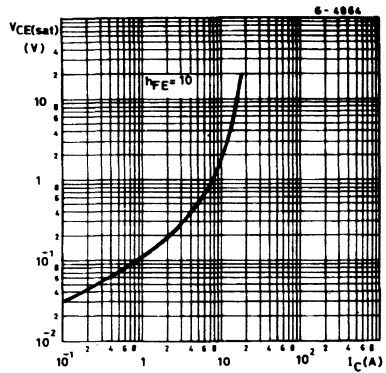

Collector-emitter Saturation Voltage (PNP types).

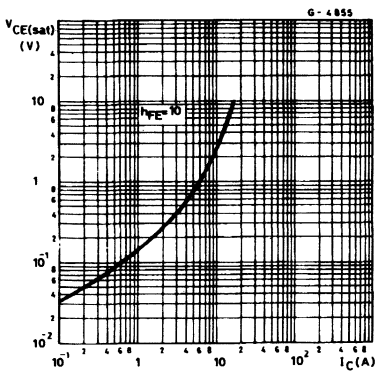

Base-emitter Saturation Voltage (NPN types).

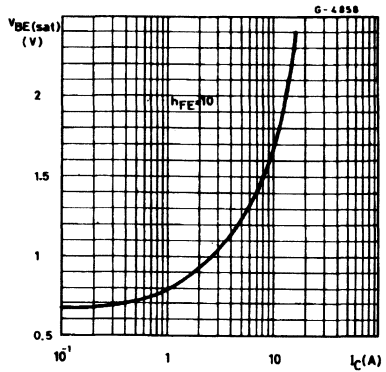

Base-emitter Saturation Voltage (PNP types).

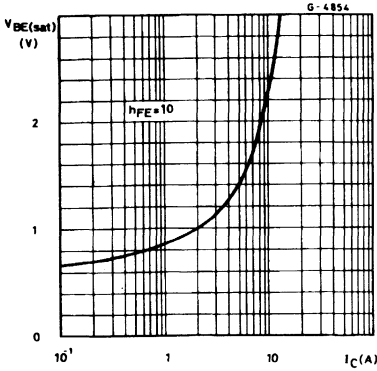

Collector-base Capacitance (NPN types).

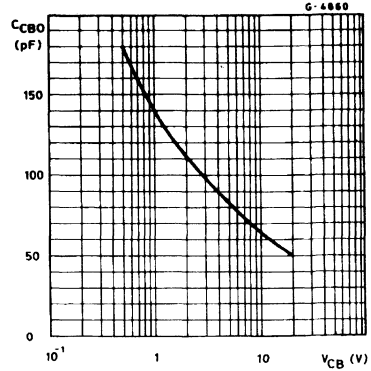

Collector-base Capacitance (PNP types).

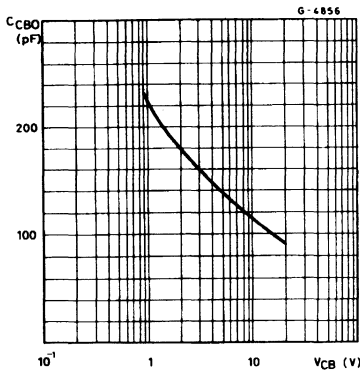

Transition Frequency (NPN types).

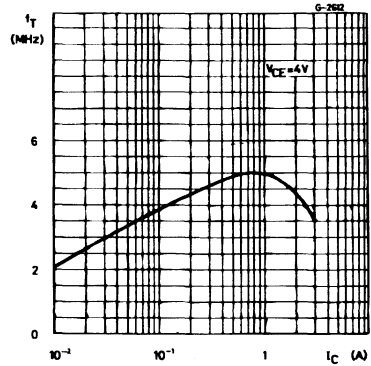

Transition Frequency (PNP types).

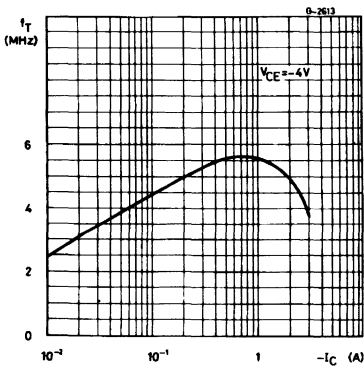

Power Rating Chart.

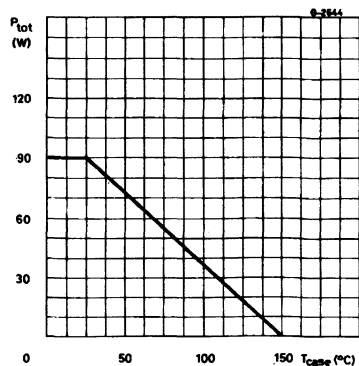

POWER DARLINGTONS

DESCRIPTION

The BDV65, BDV65A, BDV65B, are silicon epitaxial-base NPN transistors in monolithic Darlington configuration and are mounted in SOT-93 plastic package. They are intended for use in power linear and switching applications.

The complementary PNP types are BDV64, BDV64A, BDV64B respectively.

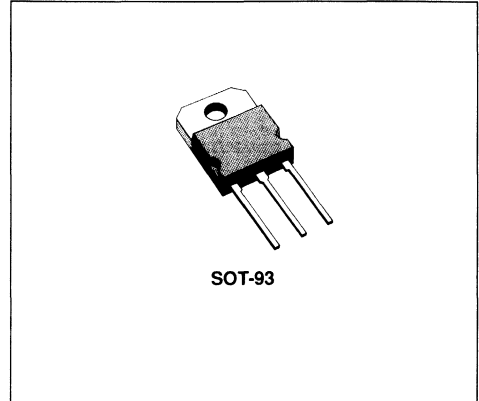

INTERNAL SCHEMATIC DIAGRAMS

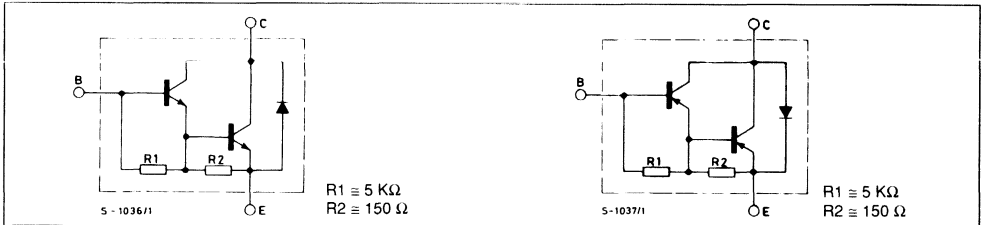

ABSOLUTE MAXIMUM RATINGS

Symbol	Parameter	* PNP NPN	Value			Unit
			BDV64 BDV65	BDV64A BDV65A	BDV64B BDV65B	
V_{CBO}	Collector-base Voltage ($I_E = 0$)		60	80	100	V
V_{CEO}	Collector-emitter Voltage ($I_B = 0$)		60	80	100	V
V_{EBO}	Emitter-base Voltage ($I_C = 0$)		5			V
I_C	Collector Current		12			A
I_{CM}	Collector Peak Current (repetitive)		20			A
I_B	Base Current		0.5			A
P_{tot}	Total Power Dissipation at $T_{case} \leq 25\text{ }^\circ\text{C}$		125			W
T_{stg}	Storage Temperature		- 65 to 150			$^\circ\text{C}$
T_j	Junction Temperature		150			$^\circ\text{C}$

* For PNP types voltage and current values are negative.

THERMAL DATA

$R_{th\ j-case}$	Thermal Resistance Junction-case	Max	1	°C/W
------------------	----------------------------------	-----	---	------

ELECTRICAL CHARACTERISTICS ($T_{case} = 25\text{ °C}$ unless otherwise specified)

Symbol	Parameter	Test Conditions	Min.	Typ.	Max.	Unit
I_{CBO}	Collector Cutoff Current ($I_E = 0$)	for BDV64/5 $V_{CB} = 60\text{ V}$ for BDV64A/5A $V_{CB} = 80\text{ V}$ for BDV64B/5B $V_{CB} = 100\text{ V}$ $T_{case} = 150\text{ °C}$ for BDV64/65 $V_{CB} = 30\text{ V}$ for BDV64A/5A $V_{CB} = 40\text{ V}$ for BDV64B/5B $V_{CB} = 50\text{ V}$			400 400 400 2 2 2	μA μA μA mA mA mA
I_{CEO}	Collector Cutoff Current ($I_B = 0$)	for BDV64/65 $V_{CE} = 30\text{ V}$ for BDV64A/5A $V_{CE} = 40\text{ V}$ for BDV64B/5B $V_{CE} = 50\text{ V}$			1 1 1	mA mA mA
I_{EBO}	Emitter Cutoff Current ($I_C = 0$)	$V_{EBO} = 5\text{ V}$			5	mA
$V_{CEO(sus)}^*$	Collector-emitter Sustaining Voltage ($I_B = 0$)	$I_C = 30\text{ mA}$ for BDV64/65 for BDV64A/5A for BDV64B/5B	60 80 100			V V V
$V_{CE(sat)}^*$	Collector-emitter Saturation Voltage	$I_C = 5\text{ A}$ $I_B = 20\text{ mA}$			2	V
V_{BE}^*	Base-emitter Voltage	$I_C = 5\text{ A}$ $V_{CE} = 4\text{ V}$			2.5	V
h_{FE}^*	DC Current Gain	$I_C = 1\text{ A}$ $V_{CE} = 4\text{ V}$ $I_C = 5\text{ A}$ $V_{CE} = 4\text{ V}$ $I_C = 10\text{ A}$ $V_{CE} = 4\text{ V}$	1000	2500 500		
V_F	Parallel Diode Forward Voltage	$I_F = 5\text{ A}$		1.2		V
h_{fe}	Small Signal Current Gain	$I_C = 5\text{ A}$ $V_{CE} = 4\text{ V}$ $f = 1\text{ MHz}$		60		
C_{CBO}	Collector–base Capacitance	$V_{CB} = 10\text{ V}$ $I_E = 0$ $f = 1\text{ MHz}$		100		pF
t_{on}	Turn-on Time			0.5		μs
t_s	Storage Time	$I_C = 5\text{ A}$ $I_{B1} = 20\text{ mA}$		1.1** 1.3		μs μs
t_f	Fall Time	$I_{B2} = 20\text{ A}$ $V_{CC} = 16\text{ V}$		2.5** 1.0		μs μs

* Pulsed : pulse duration = 300 μs duty cycle = 1.5%.

** For PNP types,

For PNP types voltage and current values are negative.

Safe Operating Areas.

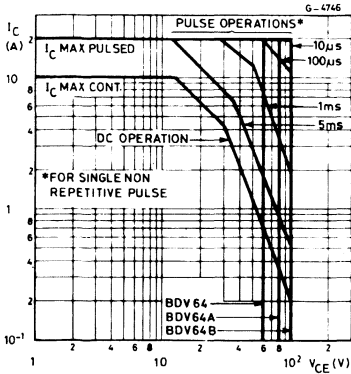

Safe Operating Areas.

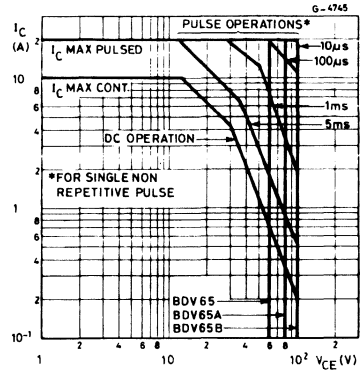

DC Current Gain (BDV64 series).

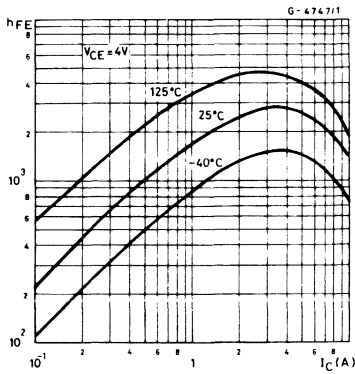

DC Transconductance (BDV64 series).

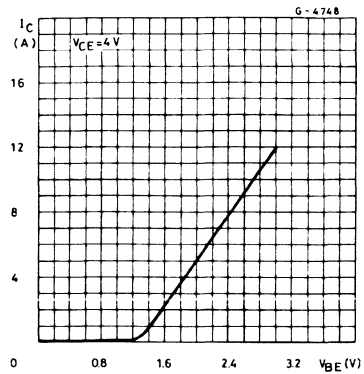

Collector-emitter Saturation Voltage (BDV64 series).

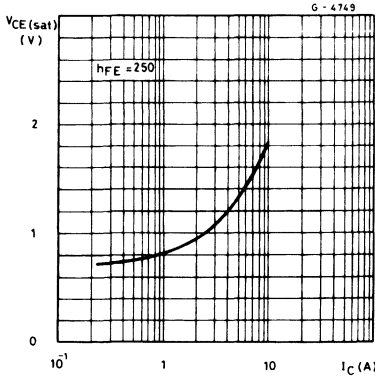

Collector-emitter Saturation Voltage (BDV64 series).

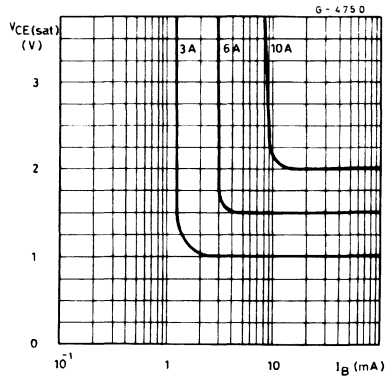

DC Current Gain (BDV65 series).

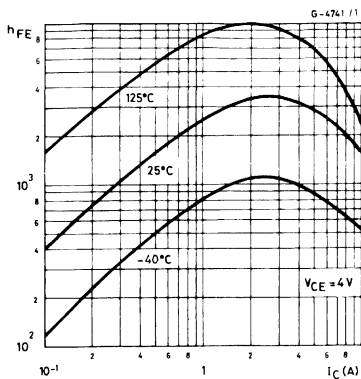

DC Transconductance (BDV65 series).

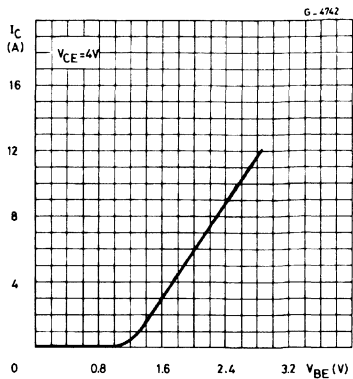

Collector-emitter Saturation Voltage (BDV65 series).

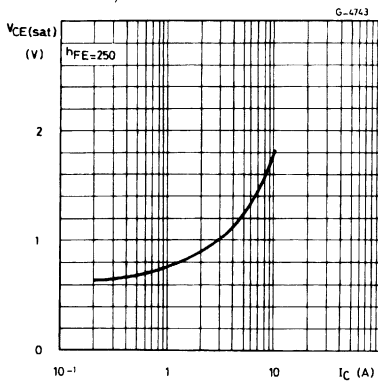

Collector-emitter Saturation Voltage (BDV65 series).

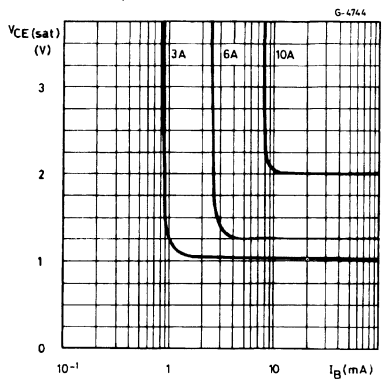

POWER LINEAR AND SWITCHING APPLICATIONS

DESCRIPTION

The BDW51, BDW51A, BDW51B and BDW51C are silicon epitaxial-base NPN power transistors in Jedec TO-3 metal case. They are intended for use in power linear and switching applications.

The complementary PNP types are the BDW52, BDW52A, BDW52B and BDW52C respectively.

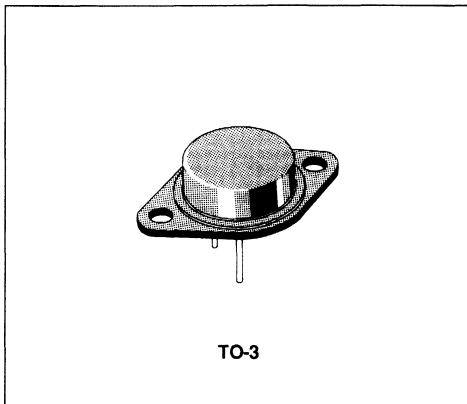

INTERNAL SCHEMATIC DIAGRAMS

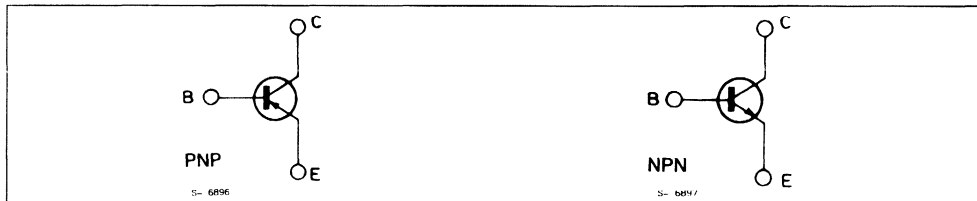

ABSOLUTE MAXIMUM RATINGS

Symbol	Parameter	NPN PNP*	Value				Unit
			BDW51 BDW52	BDW51A BDW52A	BDW51B BDW52B	BDW51C BDW52C	
V_{CBO}	Collector-base Voltage ($I_E = 0$)		45	60	80	100	V
V_{CES}	Collector-emitter Voltage ($V_{BE} = 0$)		45	60	80	100	V
V_{CEO}	Collector-emitter Voltage ($I_B = 0$)		45	60	80	100	V
V_{EBO}	Emitter-base Voltage ($I_C = 0$)		5				V
I_C	Collector Current		15				A
I_{CM}	Collector Peak Current (repetitive)		20				A
I_B	Base Current		7				A
P_{Tot}	Total Power Dissipation at $T_{case} \leq 25^\circ C$		125				W
T_{stg}	Storage Temperature		- 65 to 200				$^\circ C$
T_j	Junction Temperature		200				$^\circ C$

For PNP types voltage and current values are negative

THERMAL DATA

$R_{thj-case}$	Thermal Resistance Junction-case	Max	1.4	°C/W
----------------	----------------------------------	-----	-----	------

ELECTRICAL CHARACTERISTICS ($T_{case} = 25\text{ °C}$ unless otherwise specified)

Symbol	Parameter	Test Conditions	Min.	Typ.	Max.	Unit
I_{CBO}	Collector Cutoff Current ($I_E = 0$)	for BDW51/52 $V_{CB} = 45\text{ V}$ for BDW51A/52A $V_{CB} = 60\text{ V}$ for BDW51B/52B $V_{CB} = 80\text{ V}$ for BDW51C/52C $V_{CB} = 100\text{ V}$ $T_{case} = 150\text{ °C}$ for BDW51/52 $V_{CB} = 45\text{ V}$ for BDW51A/52A $V_{CB} = 60\text{ V}$ for BDW51B/52B $V_{CB} = 80\text{ V}$ for BDW51C/52C $V_{CB} = 100\text{ V}$			500 500 500 500 5 5 5 5	μA μA μA μA mA mA mA mA
I_{CEO}	Collector Cutoff Current ($I_B = 0$)	for BDW51/52 $V_{CE} = 22\text{ V}$ for BDW51A/52A $V_{CE} = 30\text{ V}$ for BDW51B/52B $V_{CE} = 40\text{ V}$ for BDW51C/52C $V_{CE} = 50\text{ V}$			1 1 1 1	mA mA mA mA
I_{EBO}	Emitter Cutoff Current ($I_C = 0$)	$V_{EB} = 5\text{ V}$			2	mA
$V_{CEO(sus)}^*$	Collector-emitter Sustaining Voltage ($I_B = 0$)	$I_C = 100\text{ mA}$ for BDW51/52 for BDW51A/52A for BDW51B/52B for BDW51C/52C	45 60 80 100			V V V V
$V_{CE(sat)}^*$	Collector-emitter Saturation Voltage	$I_C = 5\text{ A}$ $I_B = 0.5\text{ A}$ $I_C = 10\text{ A}$ $I_B = 2.5\text{ A}$			1 3	V V
$V_{BE(sat)}^*$	Base-emitter Saturation Voltage	$I_C = 10\text{ A}$ $I_B = 2.5\text{ A}$			2.5	V
V_{BE}^*	Base-emitter Voltage	$I_C = 5\text{ A}$ $V_{CE} = 4\text{ V}$			1.5	V
h_{FE}^*	DC Current Gain	$I_C = 5\text{ A}$ $V_{CE} = 4\text{ V}$ $I_C = 10\text{ A}$ $V_{CE} = 4\text{ V}$	20 5		150	
f_T	Transition Frequency	$I_C = 0.5\text{ A}$ $V_{CE} = 4\text{ V}$	3			MHz

* Pulsed : pulse duration = 300 μs , duty cycle = 1.5 %.
For PNP types voltage and current values are negative.

Safe Operating Areas (for **BDW51, BDW51A, BDW52, BDW52A**).

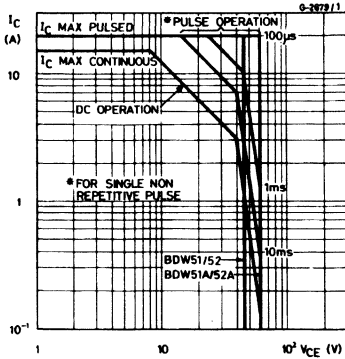

Safe Operating Areas (for **BDW51B, BDW51C, BDW52B, BDW52C**).

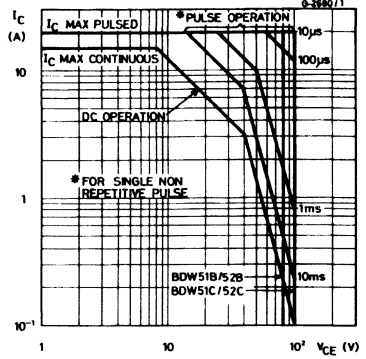

DC Current Gain (NPN types).

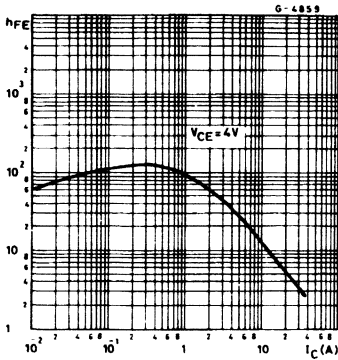

DC Current Gain (PNP types).

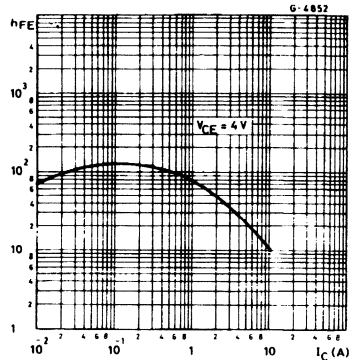

DC Transconductance (NPN types).

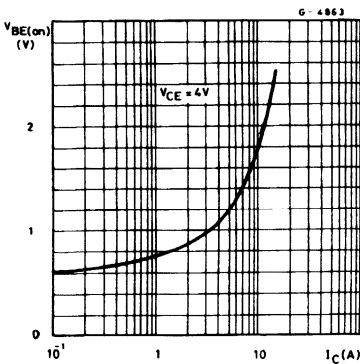

DC Transconductance (PNP types).

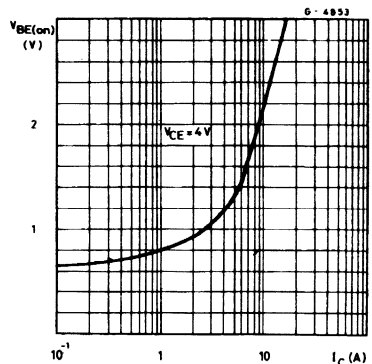

Collector-emitter Saturation Voltage (NPN types).

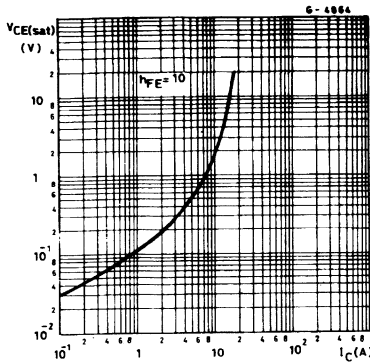

Collector-emitter Saturation Voltage (PNP types).

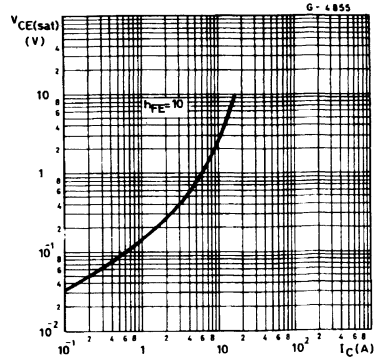

Base-emitter Saturation Voltage (NPN types).

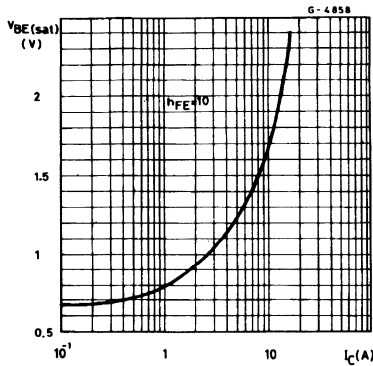

Base-emitter Saturation Voltage (PNP types).

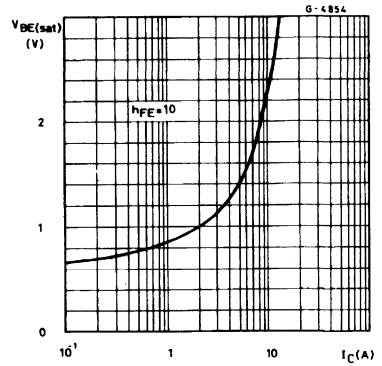

Collector-base Capacitance (NPN types).

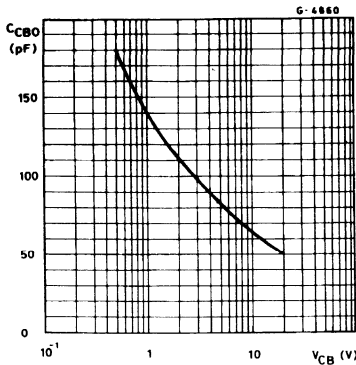

Collector-base Capacitance (PNP types).

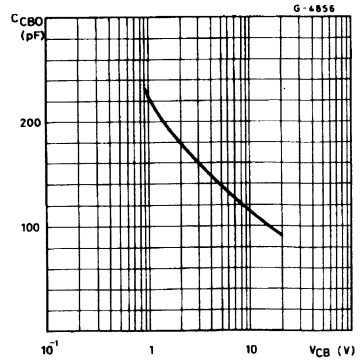

Transition Frequency (NPN types).

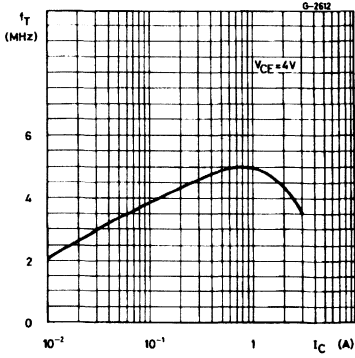

Transition Frequency (PNP types).

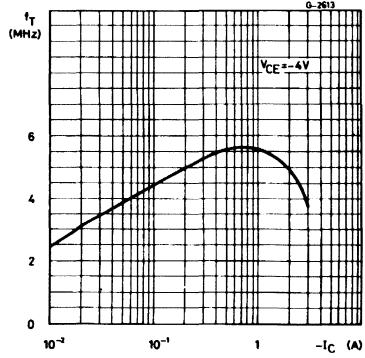

Saturated Switching Characteristics (NPN types).

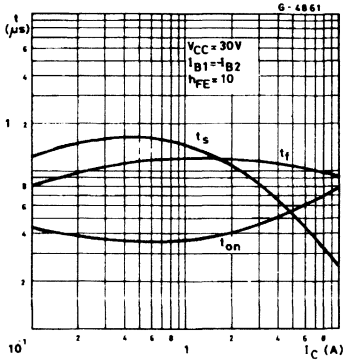

Saturated Switching Characteristics (PNP types).

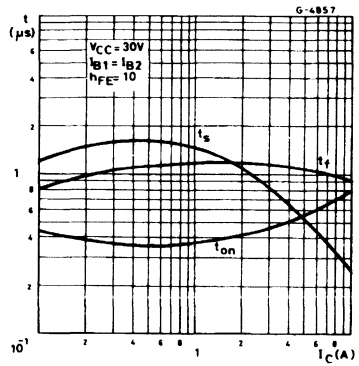

Power Rating Chart.

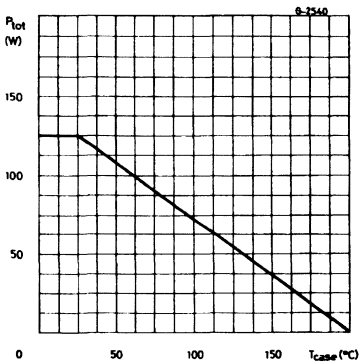

HIGH CURRENT POWER DARLINGTON

- HIGH CURRENT
- HIGH GAIN

DESCRIPTION

The BDW83A/B/C are silicon epitaxial base NPN power monolithic Darlington mounted in TO-218 plastic package. They are intended for use in power linear and switching applications.

The complementary PNP types are BDW84A/B/C respectively.

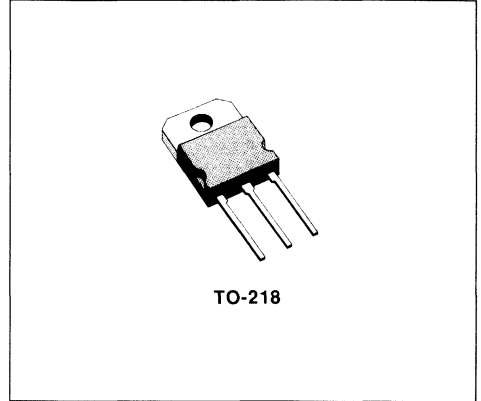

INTERNAL SCHEMATIC DIAGRAM

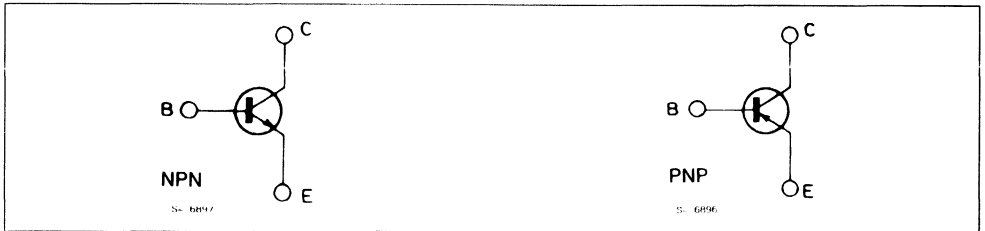

ABSOLUTE MAXIMUM RATINGS

Symbol	Parameter	NPN PNP	Value			Unit
			BDW83A BDW84A	BDW83B BDW84B	BDW83C BDW84C	
V_{CBO}	Collector-base Voltage ($I_E = 0$)		60	80	100	V
V_{CEO}	Collector-emitter Voltage ($I_B = 0$)		60	80	100	V
V_{EBO}	Emitter-base Voltage ($I_C = 0$)		5			V
I_C	Collector Current		15			A
I_{CM}	Collector Peak Current		40			A
I_B	Base Current		0.5			A
P_{tot}	Total Dissipation at $T_C < 25^\circ\text{C}$		130			W
T_{stg}	Storage Temperature		- 65 to 150			$^\circ\text{C}$
T_j	Max. Operating Junction Temperature		150			$^\circ\text{C}$

For PNP types voltage and current values are negative.

THERMAL DATA

$R_{th\ j-case}$	Thermal Resistance Junction-case	Max	0.96	°C/W
------------------	----------------------------------	-----	------	------

ELECTRICAL CHARACTERISTICS($T_j = 25^\circ\text{C}$ unless otherwise specified)

Symbol	Parameter	Test Conditions		Min.	Typ.	Max.	Unit	
I_{CBO}	Collector Cutoff Current ($I_E = 0$)	$V_{CB} = 60\text{V}$	for BDW83A/84A			0.5	mA	
		$V_{CB} = 80\text{V}$	for BDW83B/84B			0.5	mA	
		$V_{CB} = 100\text{V}$	for BDW83C/84C			0.5	mA	
		$T_C = 150^\circ\text{C}$						
		$V_{CB} = 60\text{V}$	for BDW83A/84A			5	mA	
		$V_{CB} = 80\text{V}$	for BDW83B/84B			5	mA	
$V_{CB} = 100\text{V}$	for BDW83C/84C			5	mA			
I_{CEO}	Collector Cutoff Current ($I_B = 0$)	$V_{CE} = 30\text{V}$	for BDW83A/84A			1	mA	
		$V_{CE} = 40\text{V}$	for BDW83B/84B			1	mA	
		$V_{CE} = 40\text{V}$	for BDW83C/84C			1	mA	
I_{EBO}	Emitter Cutoff Current ($I_C = 0$)	$V_{EB} = 5\text{V}$				2	mA	
Space 1	Collector Emitter Sustaining Voltage	$I_C = 30\text{mA}$	for BDW83A/84A	60			V	
			for BDW83B/84B	80			V	
			for BDW83C/84C	100			V	
$V_{CE(sat)}^*$	Collector-emitter Saturation Voltage	$I_C = 6\text{A}$	$I_B = 12\text{mA}$			2.5	V	
		$I_C = 15\text{A}$	$I_B = 150\text{mA}$			4	V	
$V_{BE(on)}^*$	Base-emitter Voltage	$I_C = 6\text{A}$	$V_{CE} = 3\text{V}$			2.5	V	
h_{FE}^*	DC Current Gain	$I_C = 6\text{A}$	$V_{CE} = 3\text{V}$	750		20K		
		$I_C = 15\text{A}$	$V_{CE} = 3\text{V}$	100				
V_f^*	Diode Forward Voltage	$I_F = 10\text{A}$				4	V	
t_{on} t_{off}	Turn-on Time	$V_{CC} = 30\text{V}$	$I_C = 10\text{A}$		0.9		μs	
	Turn-off Time	$R_{B1} = 300\Omega$	$R_{B2} = 150\Omega$		6		μs	
		$I_{B1} = -I_{B2} = 40\text{mA}$						

* Pulsed : Pulse duration = 300 μs , duty cycle = 1.5%.
For PNP types voltage and current values are negative.

MEDIUM POWER DARLINGTON

DESCRIPTION

The BDW91 is a silicon epitaxial base NPN transistor in monolithic Darlington configuration mounted in Jedec TO-39 metal case. It is intended for use in switching and linear applications. The complementary PNP type is the BDW92.

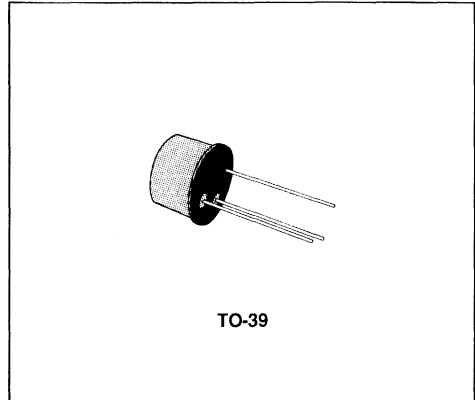

INTERNAL SCHEMATIC DIAGRAMS

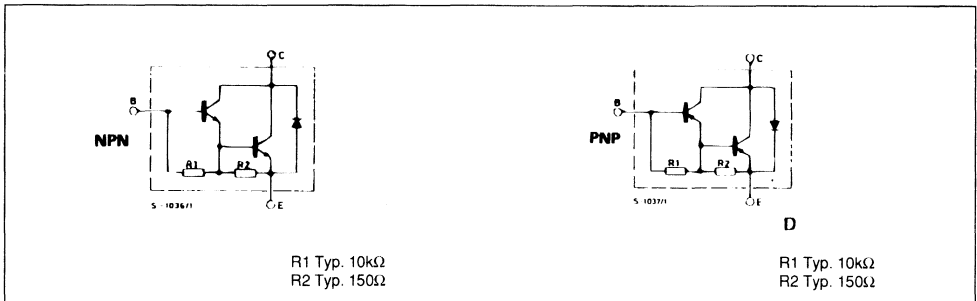

ABSOLUTE MAXIMUM RATINGS

Symbol	Parameter	Value	Unit
V_{CBO}	Collector-base Voltage ($I_E = 0$)	180	V
V_{CEO}	Collector-emitter Voltage ($I_B = 0$)	180	V
V_{EBO}	Emitter-base Voltage ($I_C = 0$)	6	V
I_C	Collector Current	4	A
I_B	Base Current	100	mA
P_{Tot}	Total Power Dissipation at $T_{case} \leq 25^\circ\text{C}$ $T_{amb} \leq 25^\circ\text{C}$	10 1	W W
T_{stg}	Storage Temperature	- 65 to 200	$^\circ\text{C}$
T_j	Junction Temperature	200	$^\circ\text{C}$

For PNP type voltage and current values are negative.

THERMAL DATA

$R_{thj-case}$	Thermal Resistance Junction-case	Max	17.5	°C/W
$R_{thj-amb}$	Thermal Resistance Junction-ambient	Max	175	°C/W

ELECTRICAL CHARACTERISTICS ($T_{case} = 25\text{ °C}$ unless otherwise specified)

Symbol	Parameter	Test Conditions		Min.	Typ.	Max.	Unit
I_{CBO}	Collector Cutoff Current ($I_E = 0$)	$V_{CB} = 180\text{ V}$				50	μA
I_{CEO}	Collector Cutoff Current ($I_B = 0$)	$V_{CE} = 90\text{ V}$				50	μA
I_{EBO}	Emitter Cutoff Current ($I_C = 0$)	$V_{EB} = 6\text{ V}$		0.4		2	mA
$V_{CE0(sus)}^*$	Collector-emitter Sustaining Voltage	$I_C = 50\text{ mA}$		180			V
$V_{CE(sat)}^*$	Collector-emitter Saturation Voltage	$I_C = 2\text{ A}$	$I_B = 4\text{ mA}$			2	V
V_{BE}^*	Base-emitter Voltage	$I_C = 2\text{ A}$	$V_{CE} = 2\text{ V}$			2.5	V
h_{FE}^*	DC Current Gain	$I_C = 2\text{ A}$ $I_C = 50\text{ mA}$	$V_{CE} = 5\text{ V}$ $V_{CE} = 5\text{ V}$	1000 150	3000 300		
V_F^*	Parallel Diode Forward Voltage	$I_F = 2\text{ A}$				2.5	V
h_{te}	Small Signal Current Gain	$I_C = 0.5\text{ A}$ $f = 1\text{ MHz}$	$V_{CE} = 2\text{ V}$		20		

* Pulsed : pulse duration = 300 μsec , duty cycle = 1 %.

For PNP type voltage and current values are negative

Safe Operating Area.

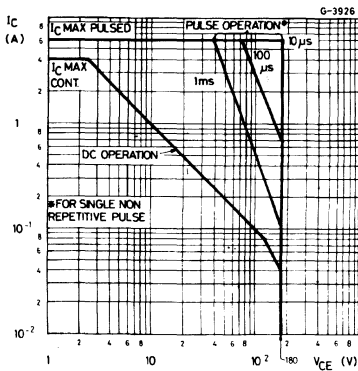

DC Current Gain (BDW91).

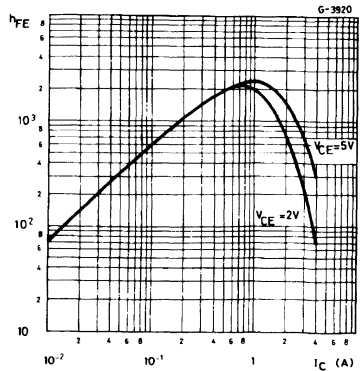

DC Current Gain (BDW92)

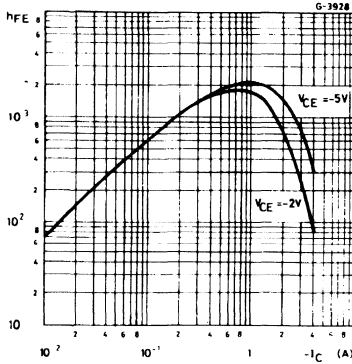

Collector-emitter Saturation Voltage (BDW91)

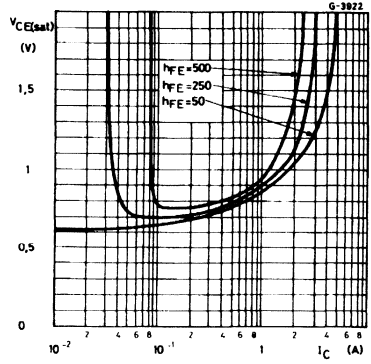

Collector-emitter Saturation Voltage (BDW92)

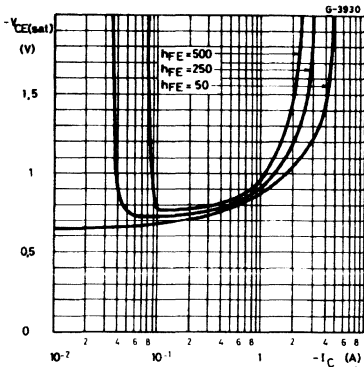

Collector-emitter Saturation Voltage (BDW91)

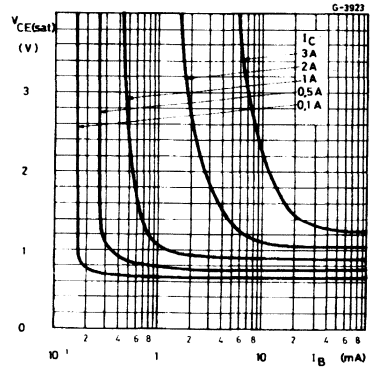

Collector-emitter Saturation Voltage (BDW92)

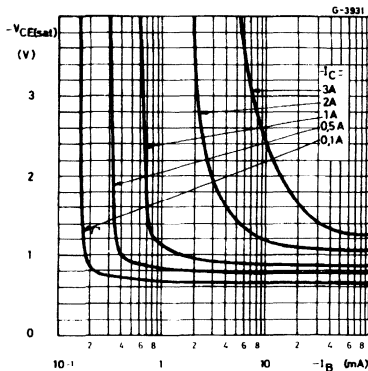

Base-emitter Saturation Voltage (BDW91)

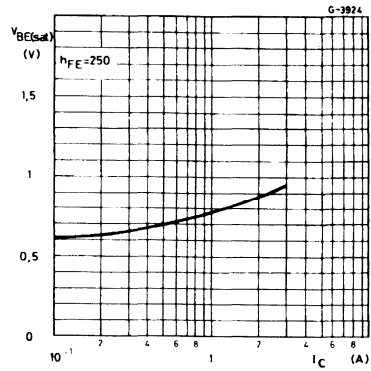

Base-emitter Saturation Voltage (BDW92)

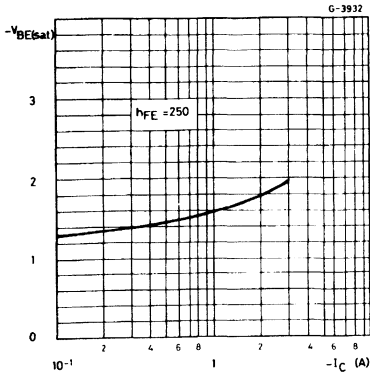

DC Transconductance (BDW92)

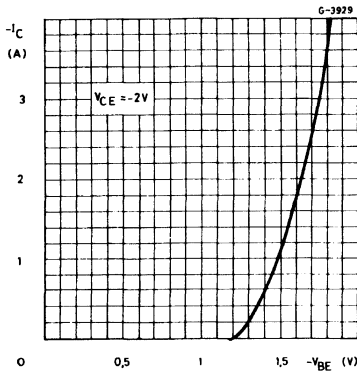

Saturated Switching Characteristics (BDW92)

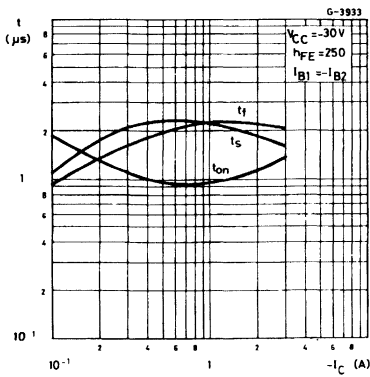

DC Transconductance (BDW91)

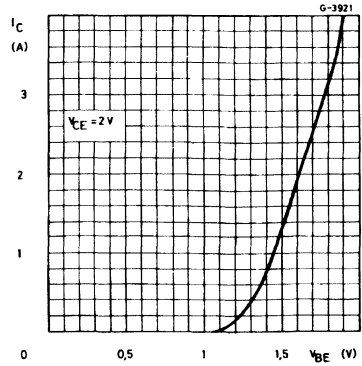

Saturated Switching Characteristics (BDW91)

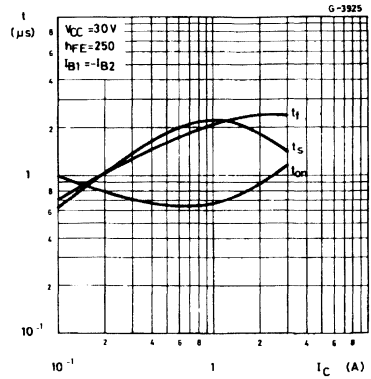

NPN/PNP POWER DARLINGTONS

DESCRIPTION

The BDW93, BDW93A, BDW93B and BDW93C are silicon epitaxial-base NPN transistors in monolithic Darlington configuration and are mounted in Jedec TO-220 plastic package. They are intended for use in power linear and switching applications. The complementary PNP types are the BDW94, BDW94A, BDW94B and BDW94C respectively.

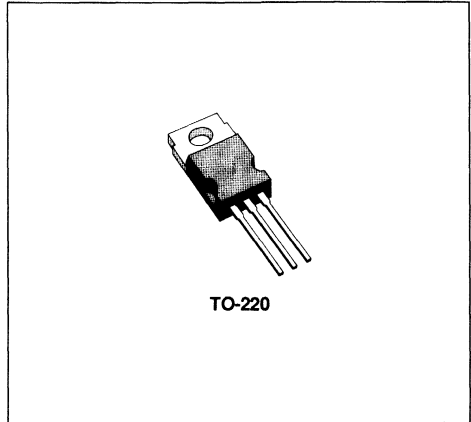

INTERNAL SCHEMATIC DIAGRAM

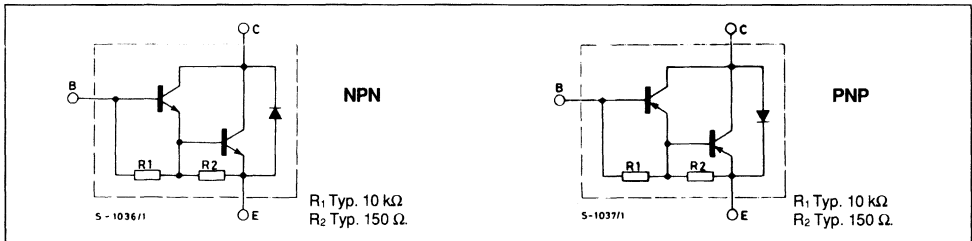

ABSOLUTE MAXIMUM RATINGS

Symbol	Parameter	NPN PNP*	Value				Unit
			BDW93 BDW94	BDW93A BDW94A	BDW93B BDW94B	BDW93C BDW94C	
V _{CB0}	Collector-base Voltage (I _E = 0)		45	60	80	100	V
V _{CE0}	Collector-emitter Voltage (I _B = 0)		45	60	80	100	V
I _C	Collector Current		12				A
I _{CM}	Collector Peak Current		15				A
I _B	Base Current		0.2				A
P _{tot}	Total Power Dissipation at T _{case} ≤ 25 °C		80				W
T _{stg}	Storage Temperature		- 65 to 150				°C
T _j	Junction Temperature		150				°C

* For PNP types voltage and current values are negative.

THERMAL DATA

$R_{th\ J-case}$	Thermal Resistance Junction-case	Max	1.56	°C/W
------------------	----------------------------------	-----	------	------

ELECTRICAL CHARACTERISTICS ($T_{case} = 25\text{ °C}$ unless otherwise specified)

Symbol	Parameter	Test Conditions	Min.	Typ.	Max.	Unit
I_{CBO}	Collector Cutoff Current ($I_E = 0$)	for BDW93/94 $V_{CB} = 45\text{ V}$ for BDW93A/94A $V_{CB} = 60\text{ V}$ for BDW93B/94B $V_{CB} = 80\text{ V}$ for BDW93C/94C $V_{CB} = 100\text{ V}$ $T_{case} = 150\text{ °C}$ for BDW93/94 $V_{CB} = 45\text{ V}$ for BDW93A/94A $V_{CB} = 60\text{ V}$ for BDW93B/94B $V_{CB} = 80\text{ V}$ for BDW93C/94C $V_{CB} = 100\text{ V}$			100 100 100 100	μA μA μA μA 5 5 5 5 mA mA mA mA
I_{CEO}	Collector Cutoff Current ($I_B = 0$)	for BDW93/94 $V_{CE} = 40\text{ V}$ for BDW93A/94A $V_{CE} = 60\text{ V}$ for BDW93B/94B $V_{CE} = 80\text{ V}$ for BDW93C/94C $V_{CE} = 80\text{ V}$			1 1 1 1	mA mA mA mA
I_{EBO}	Emitter Cutoff Current ($I_C = 0$)	$V_{EB} = 5\text{ V}$			2	mA
$V_{CEO(sus)}^*$	Collector-emitter Sustaining Voltage ($I_B = 0$)	$I_C = 100\text{ mA}$ for BDW93/94 for BDW93A/94A for BDW93B/94B for BDW93C/94C	45 60 80 100			V V V V
$V_{CE(sat)}^*$	Collector-emitter Saturation Voltage	$I_C = 5\text{ A}$ $I_B = 20\text{ mA}$ $I_C = 10\text{ A}$ $I_B = 100\text{ mA}$			2 3	V V
$V_{BE(sat)}^*$	Base-emitter Saturation Voltage	$I_C = 5\text{ A}$ $I_B = 20\text{ mA}$ $I_C = 10\text{ A}$ $I_B = 100\text{ mA}$			2.5 4	V V
h_{FE}^*	DC Current Gain	$I_C = 3\text{ A}$ $V_{CE} = 3\text{ V}$ $I_C = 5\text{ A}$ $V_{CE} = 3\text{ V}$ $I_C = 10\text{ A}$ $V_{CE} = 3\text{ V}$	1000 750 100		20000	
V_F^*	Parallel-diode Forward Voltage	$I_F = 5\text{ A}$ $I_F = 10\text{ A}$			1.3 1.8	2 4 V V
h_{fe}	Small Signal Current Gain	$I_C = 1\text{ A}$ $V_{CE} = 10\text{ V}$ $f = 1\text{ MHz}$	20			

* Pulsed : pulse duration = 300 μs , duty cycle = 1.5 %.

For PNP types voltage and current values are negative.

Safe Operating Areas (for **BDW93, BDW93A, BDW94, BDW94A**).

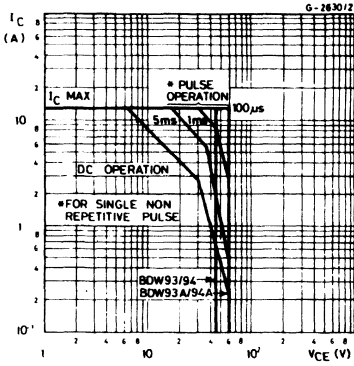

Safe Operating Areas (for **BDW93B, BDW93C, BDW94B, BDW94C**).

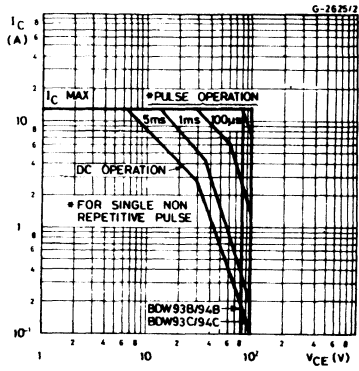

DC Current Gain (NPN types).

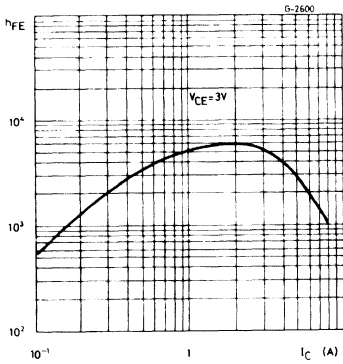

Collector-emitter Saturation Voltage (NPN types).

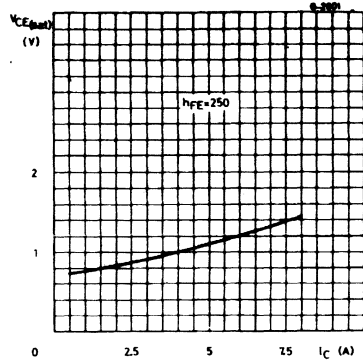

DC Transconductance (NPN types).

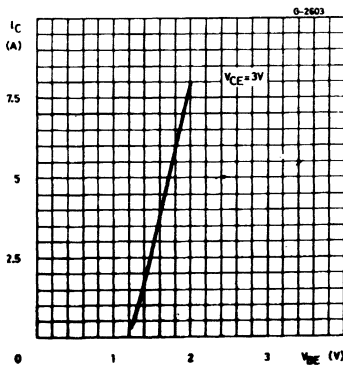

Collector-emitter Saturation Voltage (NPN types).

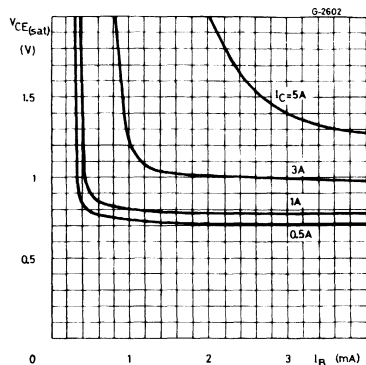

Saturated Switching Characteristics (NPN types).

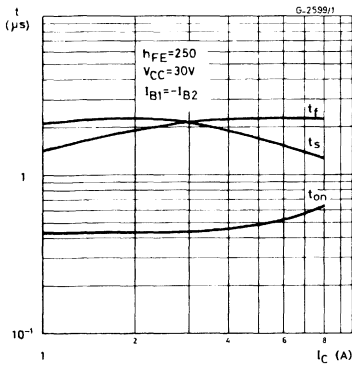

Small Signal Current Gain (NPN types).

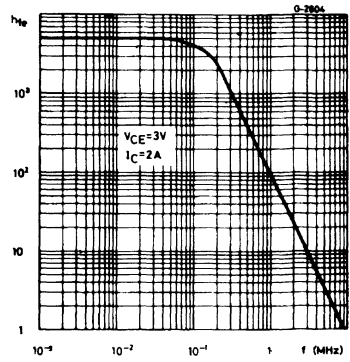

Collector-base Capacitance (PNP types).

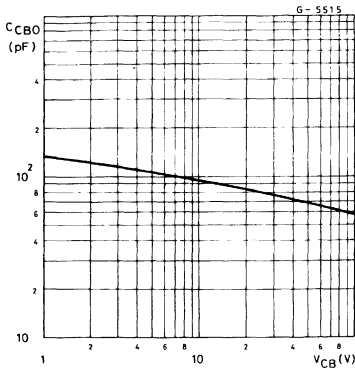

Collector-base Capacitance (NPN types).

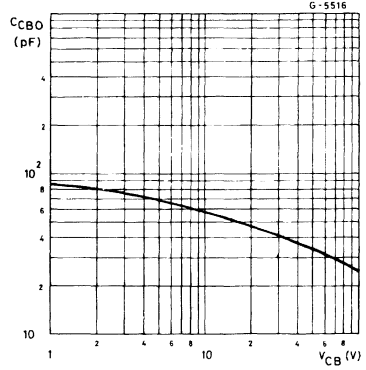

Small Signal Current Gain (PNP types).

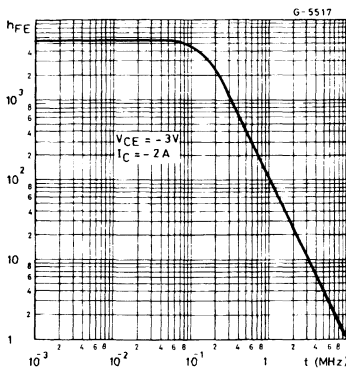

Collector-emitter Saturation Voltage (PNP types).

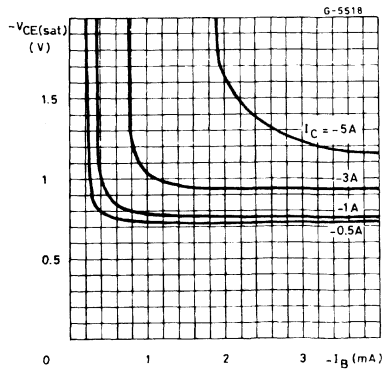

Collector-emitter Saturation Voltage (PNP types).

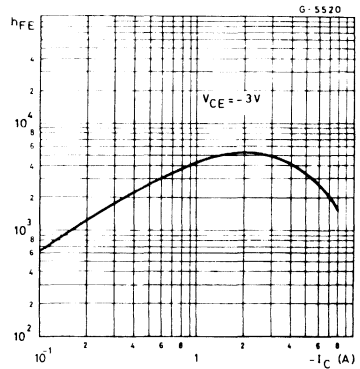
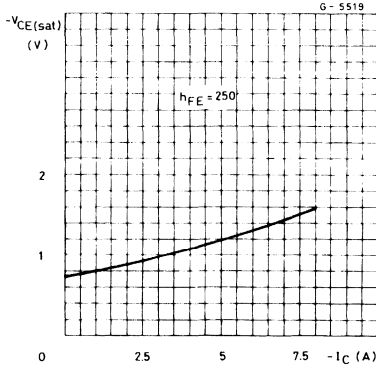

DC Transconductance (PNP types).

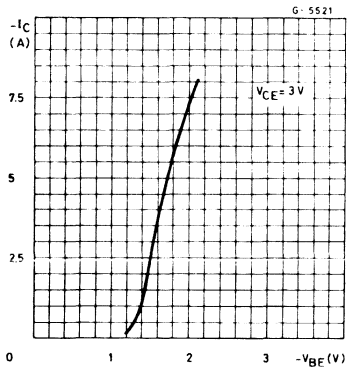

Saturated Switching Characteristics (PNP types).

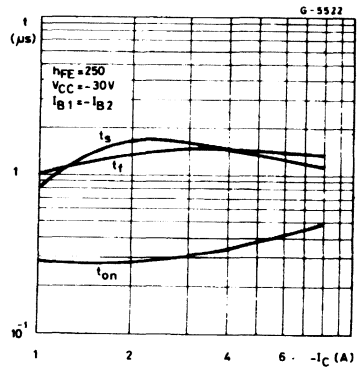

HIGH GAIN GENERAL PURPOSE

DESCRIPTION

The BDX33, BDX33A, BDX33B and BDX33C are silicon epitaxial-base NPN transistors in monolithic Darlington configuration and are mounted in Jedec TO-220 plastic package. They are intended for use in power linear and switching applications. This complementary PNP types are the BDX34, BDX34A, BDX34B and BDX34C respectively.

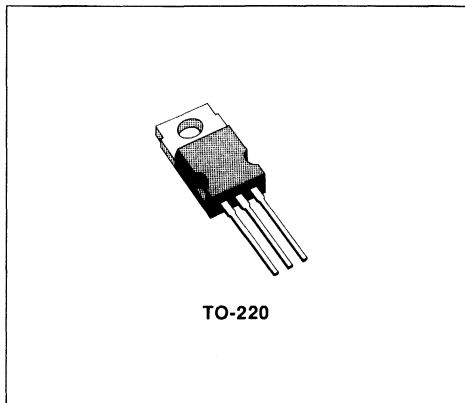

INTERNAL SCHEMATIC DIAGRAMS

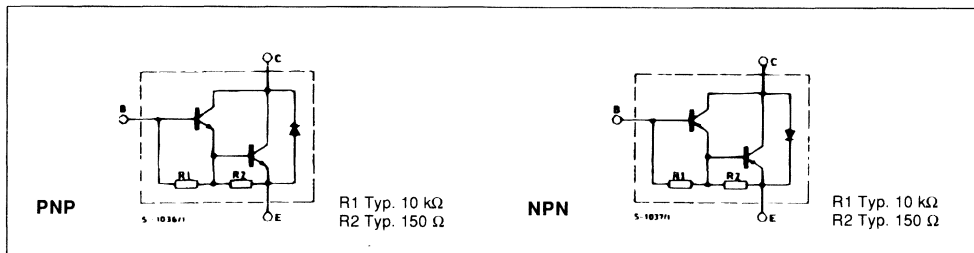

ABSOLUTE MAXIMUM RATINGS

Symbol	Parameter	NPN *PNP	Value				Unit
			BDX33 BDX34	BDX33A BDX34A	BDX33B BDX34B	BDX33C BDX34C	
V_{CBO}	Collector-base Voltage ($I_E = 0$)		45	60	80	100	V
V_{CEO}	Collector-emitter Voltage ($I_B = 0$)		45	60	80	100	V
I_C	Collector Current		10				A
I_{CM}	Collector Peak Current		15				A
I_B	Base Current		0.25				A
P_{tot}	Total Power Dissipation at $T_{case} \leq 25^\circ\text{C}$		70				W
T_{stg}	Storage Temperature		- 65 to 150				$^\circ\text{C}$
T_j	Junction Temperature		150				$^\circ\text{C}$

* For PNP types voltage and current values are negative.

THERMAL DATA

$R_{th\ j-case}$	Thermal Resistance Junction-case	Max	1.78	$^{\circ}C/W$
------------------	----------------------------------	-----	------	---------------

ELECTRICAL CHARACTERISTICS ($T_{case} = 25\ ^{\circ}C$ unless otherwise specified)

Symbol	Parameter	Test Conditions	Min.	Typ.	Max.	Unit
I_{CBO}	Collector Cutoff Current ($I_E = 0$)	for BDX33/34 $V_{CB} = 45\ V$			0.2	mA
		for BDX33A/34A $V_{CB} = 60\ V$			0.2	mA
		for BDX33B/34B $V_{CB} = 80\ V$			0.2	mA
		for BDX33C/X34C $V_{CB} = 100\ V$			0.2	mA
		$T_{case} = 100\ ^{\circ}C$				
I_{CEO}	Collector Cutoff Current ($I_B = 0$)	for BDX33/34 $V_{CB} = 22\ V$			0.5	mA
		for BDX33A/34A $V_{CB} = 30\ V$			0.5	mA
		for BDX33B/34B $V_{CB} = 40\ V$			0.5	mA
		for BDX33C/X34C $V_{CB} = 50\ V$			0.5	mA
		$T_{case} = 100\ ^{\circ}C$				
I_{EBO}	Emitter Cutoff Current ($I_C = 0$)	for BDX33/34 $V_{CB} = 22\ V$			10	mA
		for BDX33A/34A $V_{CB} = 30\ V$			10	mA
		for BDX33B/34B $V_{CB} = 40\ V$			10	mA
		for BDX33C/X34C $V_{CB} = 50\ V$			10	mA
I_{EBO}	Emitter Cutoff Current ($I_C = 0$)	$V_{EB} = 5\ V$			5	mA
$V_{CEO(sus)}^*$	Collector-emitter Sustaining Voltage ($I_B = 0$)	$I_C = 100\ mA$ for BDX33/34	45			V
		for BDX33A/34A	60			V
		for BDX33B/34B	80			V
		for BDX33C/X34C	100			V
$V_{CER(sus)}^*$	Collector-emitter Sustaining Voltage ($I_B = 0\ R_{BE} = 100\ \Omega$)	$I_C = 100\ mA$ for BDX33/34	45			V
		for BDX33A/34A	60			V
		for BDX33B/34B	80			V
		for BDX33C/X34C	100			V
$V_{CEV(sus)}^*$	Collector-emitter Sustaining Voltage ($I_B = 0\ V_{BE} = -1.5\ V$)	$I_C = 100\ mA$ for BDX33/34	45			V
		for BDX33A/34A	60			V
		for BDX33B/34B	80			V
		for BDX33C/X34C	100			V

ELECTRICAL CHARACTERISTICS (continued)

Symbol	Parameter	Test Conditions	Min.	Typ.	Max.	Unit
$V_{CE(sat)}$ *	Collector-emitter Saturation Voltage	for BDX33/33A/34/34A $I_C = 4\text{ A}$ $I_B = 8\text{ mA}$ for BDX33B/33C/34B/34C $I_C = 3\text{ A}$ $I_B = 6\text{ mA}$			2.5 2.5	V V
V_{BE} *	Base-emitter Voltage	for BDX33/33A/34/34A $I_C = 4\text{ A}$ $V_{CE} = 3\text{ V}$ for BDX33B/33C/34B/34C $I_C = 3\text{ A}$ $V_{CE} = 3\text{ V}$			2.5 2.5	V V
h_{FE} *	DC Current Gain	for BDX33/33A/34/34A $I_C = 4\text{ A}$ $V_{CE} = 3\text{ V}$ for BDX33B/33C/34B/34C $I_C = 3\text{ A}$ $V_{CE} = 3\text{ V}$	750 750			
V_F *	Parallel-diode Forward Voltage	$I_F = 8\text{ A}$			4	V
h_{fe}	Small Signal Current Gain	$I_C = 1\text{ A}$ $V_{CE} = 5\text{ V}$ $f = 1\text{ KHz}$	100			

* Pulsed : pulse duration = 300 ms, duty cycle = 1.5 %.
For PNP types voltage and current values are negative.

Safe Operating Areas.

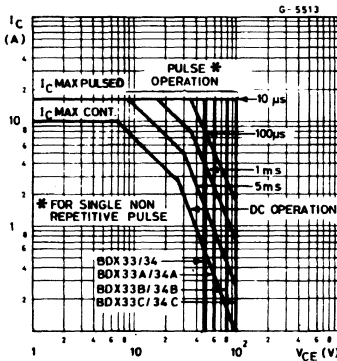

Case Temperature Dissipation Derating Curve.

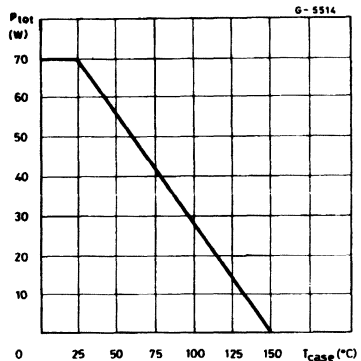

DC Current Gain (NPN types).

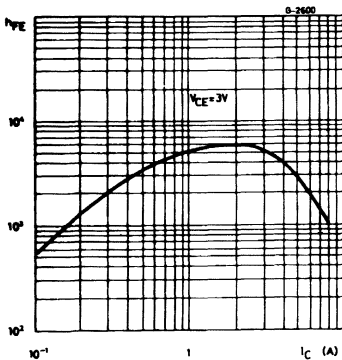

Collector-emitter Saturation Voltage (NPN types).

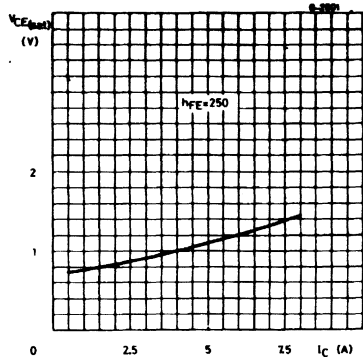

DC Transconductance (NPN types).

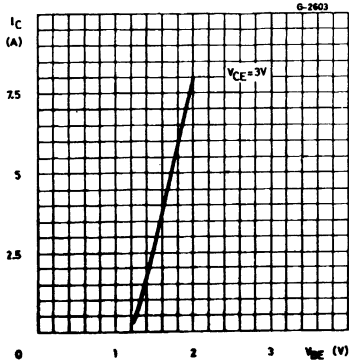

Collector-emitter Saturation Voltage (NPN types).

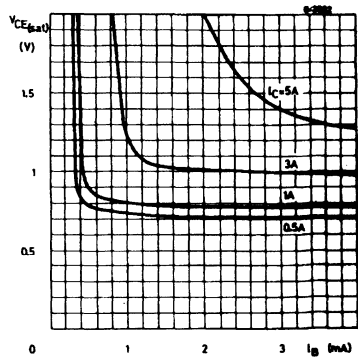

Saturated Switching Characteristics (NPN types).

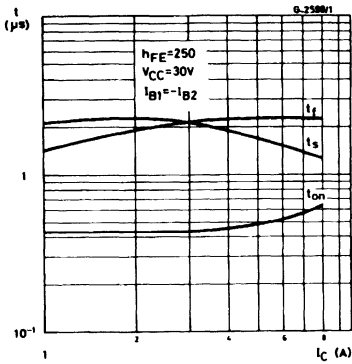

Small Signal Current Gain (NPN types).

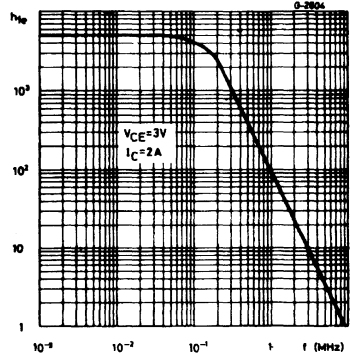

Collector-base Capacitance (PNP types).

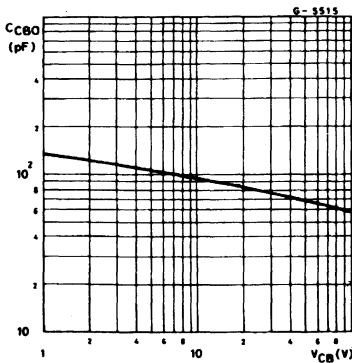

Collector-base Capacitance (NPN types).

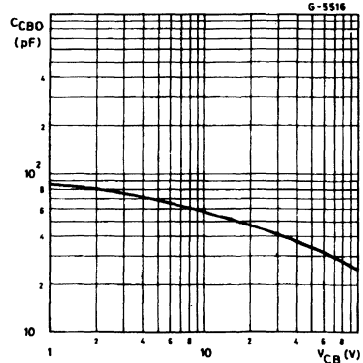

Small Signal Current Gain (PNP types).

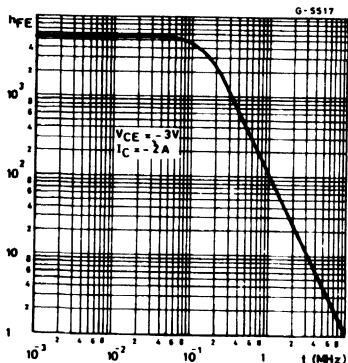

Collector-emitter Saturation Voltage (PNP types).

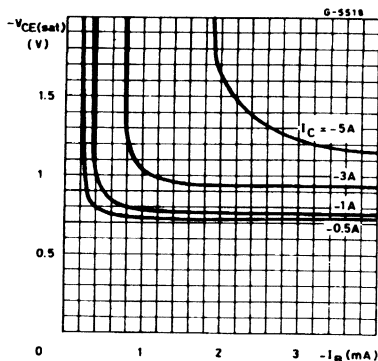

Collector-emitter Saturation Voltage (PNP types).

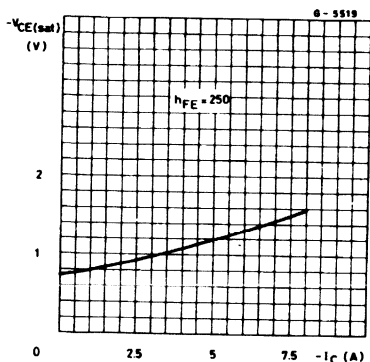

DC Current Gain (PNP types).

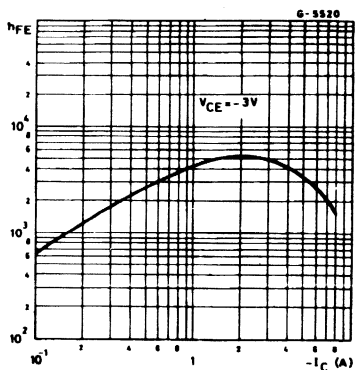

DC Transconductance (PNP types).

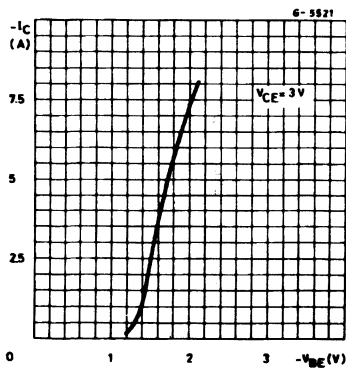

Saturated Switching Characteristics (PNP types).

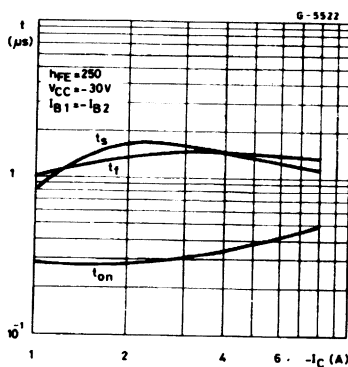

POWER DARLINGTONS

DESCRIPTION

The BDX 53, BDX 53A, BDX 53B and BDX 53C are silicon epitaxial-base NPN transistors in monolithic Darlington configuration and are mounted in Jedec TO-220 plastic package, intended for use in hammer drivers, audio amplifiers and other medium power linear and switching applications.

The complementary PNP types are the BDX 54, BDX 54A, BDX 54B and BDX 54C respectively.

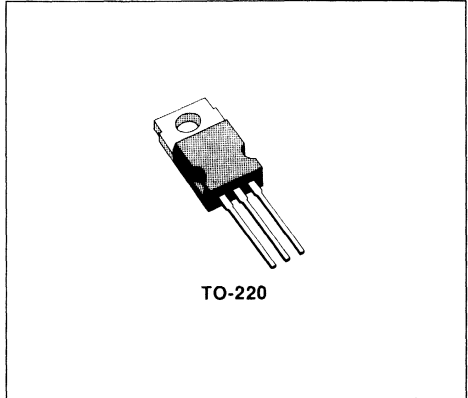

INTERNAL SCHEMATIC DIAGRAMS

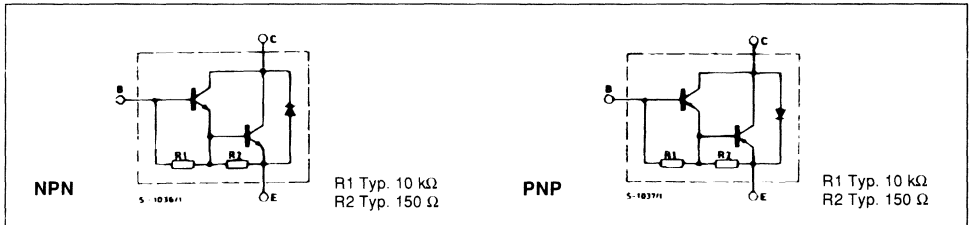

ABSOLUTE MAXIMUM RATINGS

Symbol	Parameter	NPN PNP*	Value				Unit
			BDX53 BDX54	BDX53A BDX54A	BDX53B BDX54B	BDX53C BDX54C	
V_{CBO}	Collector-base Voltage ($I_E = 0$)		45	60	80	100	V
V_{CEO}	Collector-emitter Voltage ($I_B = 0$)		45	60	80	100	V
V_{EBO}	Emitter-base Voltage ($I_C = 0$)		5				V
I_C	Collector Current		8				A
I_{CM}	Collector Peak Current (repetitive)		12				A
I_B	Base Current		0.2				A
P_{tot}	Total Power Dissipation at $T_{case} \leq 25^\circ\text{C}$		60				W
T_{stg}	Storage Temperature		- 65 to 150				$^\circ\text{C}$
T_j	Junction Temperature		150				$^\circ\text{C}$

* For PNP types voltage and current values are negative.

THERMAL DATA

$R_{th\ j-case}$	Thermal Resistance Junction-case	Max	2.08	°C/W
$R_{th\ j-amb}$	Thermal Resistance Junction-ambient	Max	70	°C/W

ELECTRICAL CHARACTERISTICS ($T_{case} = 25\text{ °C}$ unless otherwise specified)

Symbol	Parameter	Test Conditions	Min.	Typ.	Max.	Unit
I_{CBO}	Collector Cutoff Current ($I_E = 0$)	for BDX53/54 $V_{CB} = 45\text{ V}$ for BDX53A/54A $V_{CB} = 60\text{ V}$ for BDX53B/54B $V_{CB} = 80\text{ V}$ for BDX53C/54C $V_{CB} = 100\text{ V}$			200 200 200 200	μA μA μA μA
I_{CEO}	Collector Cutoff Current ($I_B = 0$)	for BDX53/54 $V_{CE} = 22\text{ V}$ for BDX53A/54A $V_{CE} = 30\text{ V}$ for BDX53B/54B $V_{CE} = 40\text{ V}$ for BDX53C/54C $V_{CE} = 50\text{ V}$			500 500 500 500	μA μA μA μA
I_{EBO}	Emitter Cutoff Current ($I_C = 0$)	$V_{EB} = 5\text{ V}$			2	mA
$V_{CEO(sus)}^*$	Collector-emitter Sustaining Voltage ($I_B = 0$)	$I_C = 100\text{ mA}$ for BDX53/54 for BDX53A/54A for BDX53B/54B for BDX53C/54C	45 60 80 100			V V V V
$V_{CE(sat)}^*$	Collector-emitter Saturation Voltage	$I_C = 3\text{ A}$ $I_B = 12\text{ mA}$			2	V
$V_{BE(sat)}^*$	Base-emitter Saturation Voltage	$I_C = 3\text{ A}$ $I_B = 12\text{ mA}$			2.5	V
h_{FE}^*	DC Current Gain	$I_C = 3\text{ A}$ $V_{CE} = 3\text{ V}$	750			
V_F	Parallel-diode Forward Voltage	$I_F = 3\text{ A}$ $I_F = 8\text{ A}$		1.8 2.5	2.5	V V

* Pulsed : pulse duration = 300 μs , duty cycle = 1.5 %.
For PNP types voltage and current values are negative.

Safe Operating Area.

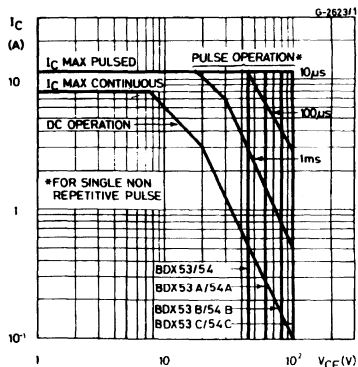

POWER DARLINGTONS

DESCRIPTION

The BDX53E, BDX53F are silicon epitaxial base NPN transistors in monolithic Darlington configuration and are mounted in Jedec TO-220 plastic package. They are intended for use in power linear and switching applications.

The complementary PNP types are the BDX54E and BDX54F respectively.

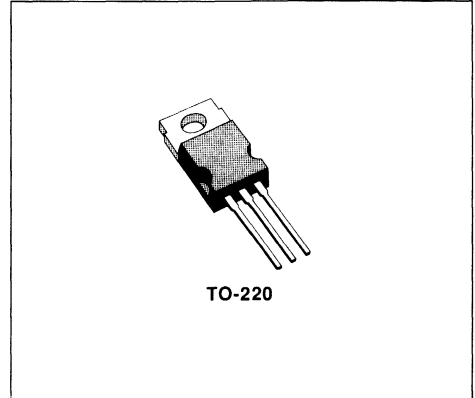

INTERNAL SCHEMATIC DIAGRAMS

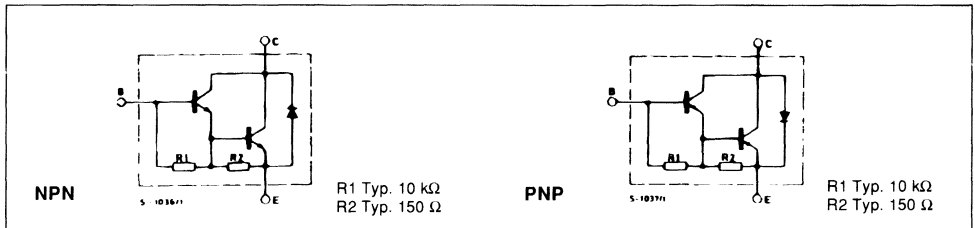

ABSOLUTE MAXIMUM RATINGS

Symbol	Parameter	NPN PNP*	Value		Unit
			BDX53E BDX54E	BDX53F BDX54F	
V_{CBO}	Collector-base Voltage ($I_E = 0$)		140	160	V
V_{CEO}	Collector-emitter Voltage ($I_B = 0$)		140	160	V
V_{EBO}	Emitter-base Voltage ($I_C = 0$)		5		V
I_C	Collector Current		8		A
I_{CM}	Collector Peak Current		12		A
I_B	Base Current		0.2		A
P_{tot}	Total Power Dissipation at $T_{case} \leq 25^\circ\text{C}$		60		W
T_{stg}	Storage Temperature		- 65 to 150		$^\circ\text{C}$
T_J	Junction Temperature		150		$^\circ\text{C}$

* For PNP types voltage and current values are negative.

THERMAL DATA

$R_{th\ j-case}$	Thermal Resistance Junction-case	Max	2.08	°C/W
$R_{th\ j-amb}$	Thermal Resistance Junction-ambient	Max	70	°C/W

ELECTRICAL CHARACTERISTICS ($T_{case} = 25\text{ °C}$ unless otherwise specified)

Symbol	Parameter	Test Conditions	Min.	Typ.	Max.	Unit
I_{CEO}	Collector Cutoff Current ($I_B = 0$)	for BDX53E/4E $V_{CE} = 70\text{ V}$ for BDX53F/4F $V_{CE} = 80\text{ V}$			0.5 0.5	mA mA
I_{CBO}	Collector Cutoff Current ($I_E = 0$)	for BDX53E/4E $V_{CB} = 140\text{ V}$ for BDX53F/4F $V_{CB} = 160\text{ V}$			0.2 0.2	mA mA
I_{EBO}	Emitter Cutoff Current ($I_E = 0$)	$V_{EB} = 5\text{ V}$			5	mA
$V_{CEO(sus)}^*$	Collector-emitter Sustaining Voltage ($I_B = 0$)	$I_C = 50\text{ mA}$ for BDX53E/BDX54E for BDX53F/BDX54F	140 160			V V
$V_{CE(sat)}^*$	Collector-emitter Saturation Voltage	$I_C = 2\text{ A}$ $I_B = 10\text{ mA}$			2	V
$V_{BE(sat)}^*$	Base-emitter Saturation Voltage	$I_C = 2\text{ A}$ $I_B = 10\text{ mA}$			2.5	V
h_{FE}^*	DC Current Gain	$I_C = 2\text{ A}$ $V_{CE} = 5\text{ V}$ $I_C = 3\text{ A}$ $V_{CE} = 5\text{ V}$	500 150			
V_F^*	Parallel Diode Forward Voltage	$I_F = 2\text{ A}$			2.5	V
h_{fe}	Small Signal Current Gain	$I_C = 0.5\text{ A}$ $f = 1\text{ MHz}$ $V_{CE} = 2\text{ V}$		20		

* Pulsed : pulse duration = 300 μs , duty cycle = 1 %.
For PNP types voltage and current values are negative.

Safe Operating Areas.

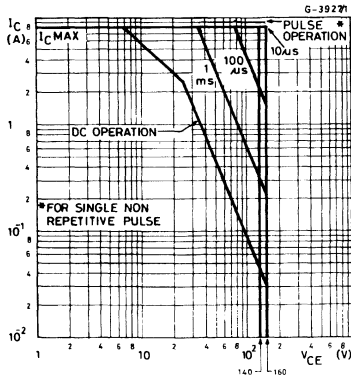

DC Current Gain (NPN types).

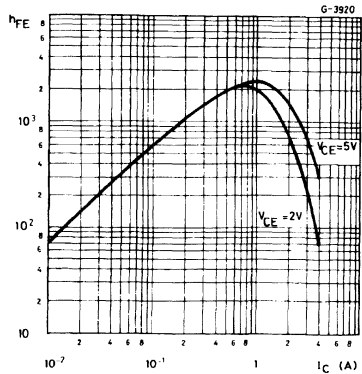

DC Current Gain (PNP types).

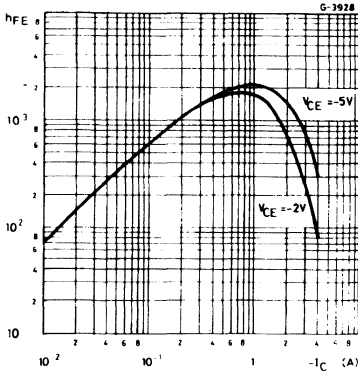

DC Transconductance (NPN types).

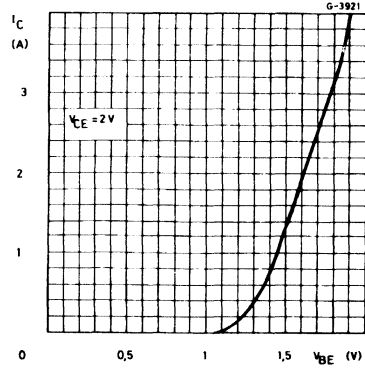

DC Transconductance (PNP types).

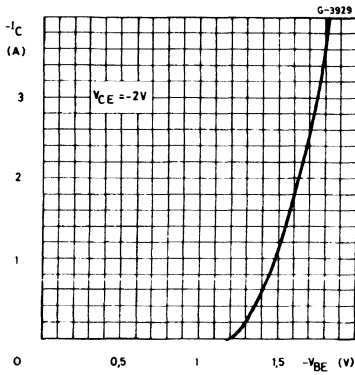

Collector-emitter Saturation Voltage (NPN types).

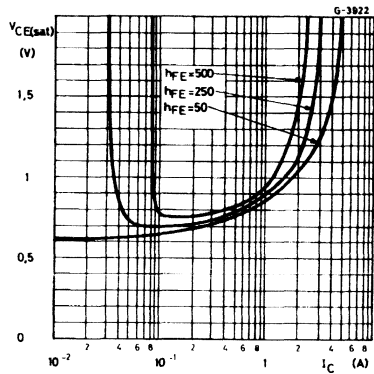

Collector-emitter Saturation Voltage (PNP types).

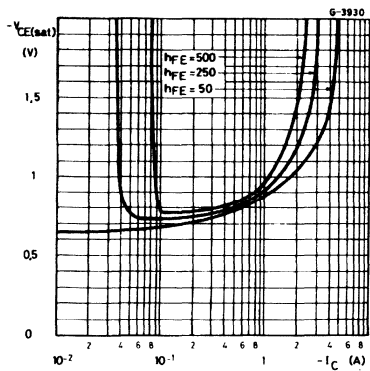

Collector-emitter Saturation Voltage (NPN types).

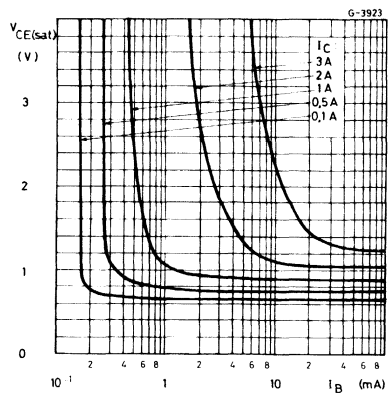

Collector-emitter Saturation Voltage (PNP types).

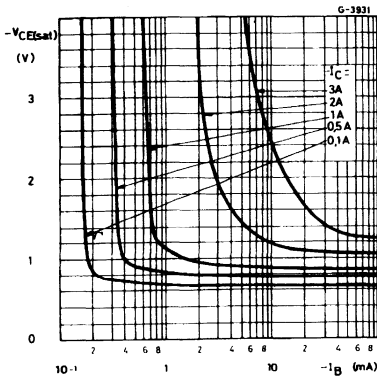

Base-emitter Saturation Voltage (NPN types).

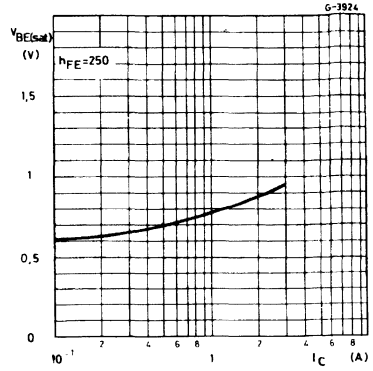

Base-emitter Saturation Voltage (PNP types).

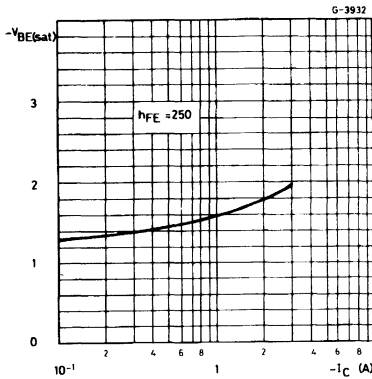

Saturated Switching Characteristics (NPN types).

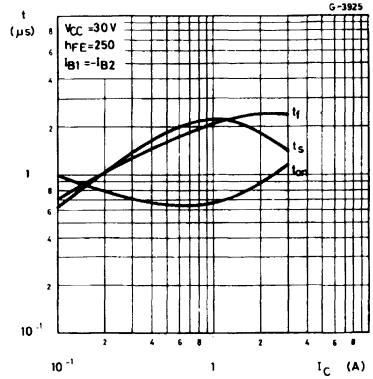

Saturated Switching Characteristics (PNP types).

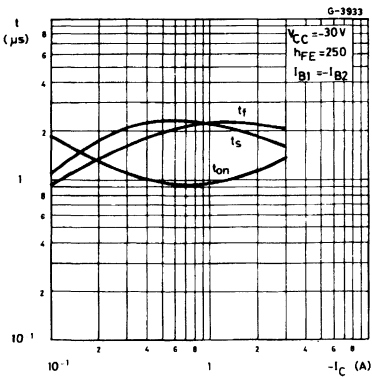

MEDIUM POWER DARLINGTONS

DESCRIPTION

The BDX53S is a silicon epitaxial-base NPN transistor in monolithic Darlingtion configuration and is mounted in Jedec TO-39 metal case.

It is intended for use in medium in power linear and switching applications.

The complementary PNP type is the BDX54S.

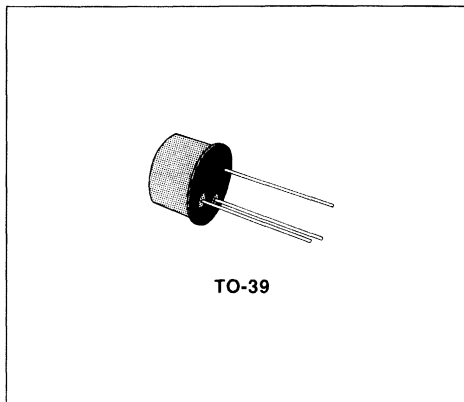

INTERNAL SCHEMATIC DIAGRAMS

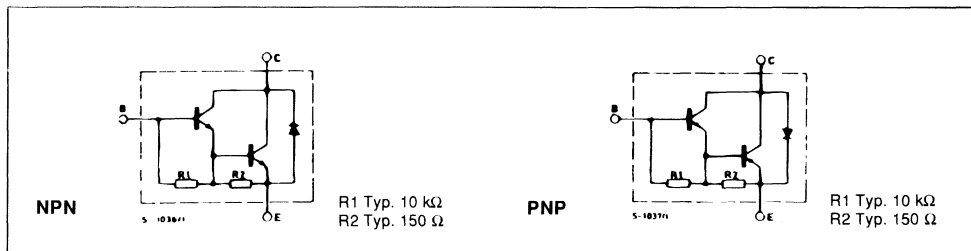

ABSOLUTE MAXIMUM RATINGS

Symbol	Parameter	Value	Unit
V_{CBO}	Collector-base Voltage ($I_E = 0$)	150	V
V_{CEO}	Collector-emitter Voltage ($I_B = 0$)	150	V
V_{EBO}	Emitter-base Voltage ($I_C = 0$)	5	V
I_C	Collector Current	6	A
I_{CM}	Collector Peak Current	10	A
I_B	Base Current	0.2	A
P_{tot}	Total Power Dissipation at $T_{case} \leq 25\text{ }^\circ\text{C}$ $T_{amb} \leq 25\text{ }^\circ\text{C}$	15	W
		1	W
T_{stg}	Storage Temperature	- 65 to 200	$^\circ\text{C}$
T_J	Junction Temperature	200	$^\circ\text{C}$

* For PNP types voltage and current values are negative.

THERMAL DATA

$R_{th\ j-case}$	Thermal Resistance Junction-case	Max	11.66	°C/W
$R_{th\ j-amb}$	Thermal Resistance Junction-ambient	Max	175	°C/W

ELECTRICAL CHARACTERISTICS ($T_{case} = 25\text{ °C}$ unless otherwise specified)

Symbol	Parameter	Test Conditions	Min.	Typ.	Max.	Unit
I_{CBO}	Collector Cutoff Current ($I_E = 0$)	$V_{CB} = 150\text{ V}$ $V_{CB} = 150\text{ V}$ $T_{case} = 125\text{ °C}$			0.2 2	mA mA
I_{CEO}	Collector Cutoff Current ($I_B = 0$)	$V_{CE} = 75\text{ V}$			0.2	mA
I_{EBO}	Emitter Cutoff Current ($I_C = 0$)	$V_{EB} = 5\text{ V}$			5	mA
$V_{CEO(sus)}^*$	Collector-emitter Sustaining Voltage ($I_B = 0$)	$I_C = 50\text{ mA}$	150			V
$V_{CE(sat)}^*$	Collector-emitter Saturation Voltage	$I_C = 2\text{ A}$ $I_B = 8\text{ mA}$			2	V
$V_{BE(sat)}^*$	Base-emitter Saturation Voltage	$I_C = 2\text{ A}$ $I_B = 8\text{ mA}$			2.5	V
h_{FE}^*	DC Current Gain	$I_C = 100\text{ mA}$ $V_{CE} = 5\text{ V}$ $I_C = 2\text{ A}$ $V_{CE} = 5\text{ V}$	100 500			
V_F^*	Parallel Diode Forward Voltage	$I_F = 2\text{ A}$			2.5	V
h_{fe}	Small Signal Current Gain	$I_C = 0.5\text{ A}$ $V_{CE} = 2\text{ V}$ $f = 1\text{ MHz}$		20		

* Pulsed : pulse duration = 300 ms, duty cycle = 1 %.
For PNP type voltage and current values are negative.

Safe Operating Area.

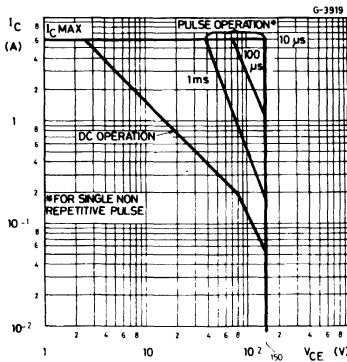

DC Current Gain (BDX53S).

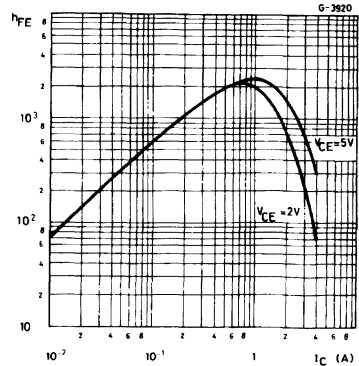

DC Current Gain (BDX54S).

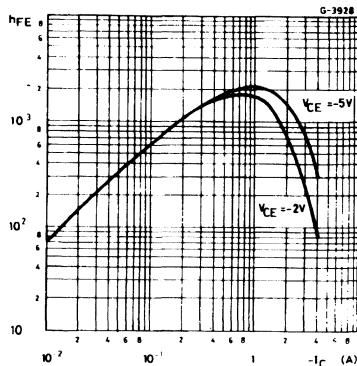

DC Transconductance (BDX53S).

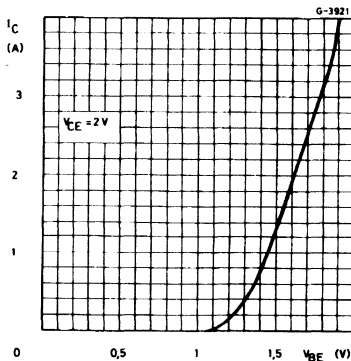

DC Transconductance (BDX54S).

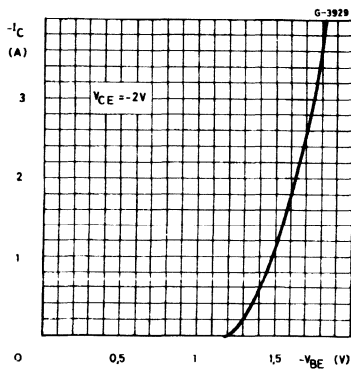

Collector-emitter Saturation Voltage (BDX53S).

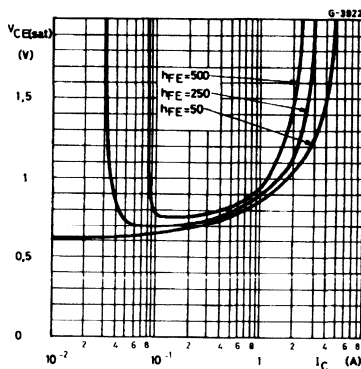

Collector-emitter Saturation Voltage (BDX54S).

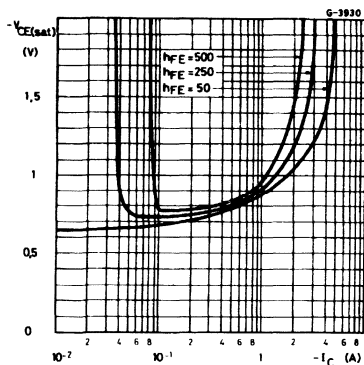

Collector-emitter Saturation Voltage (BDX53S).

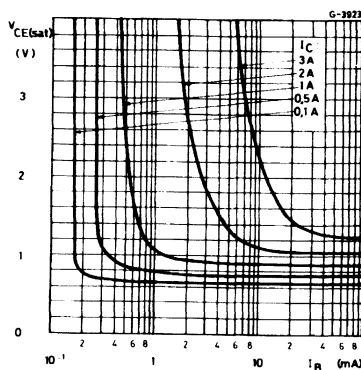

Collector-emitter Saturation Voltage (BDX54S).

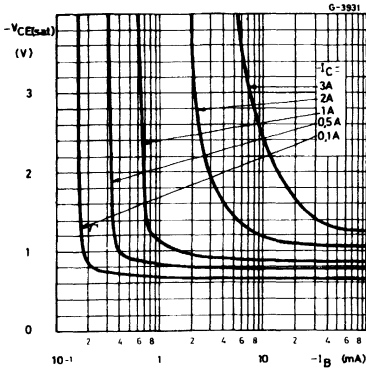

Base-emitter Saturation Voltage (BDX53S).

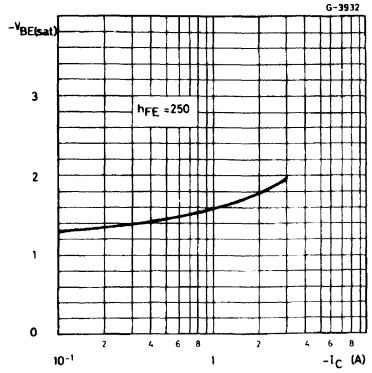

Base-emitter Saturation Voltage (BDX54S).

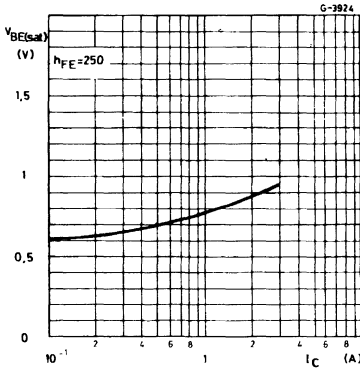

Saturated Switching Characteristics (BDX53S).

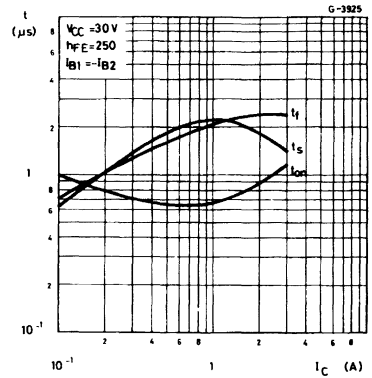

Saturated Switching Characteristics (BDX54S).

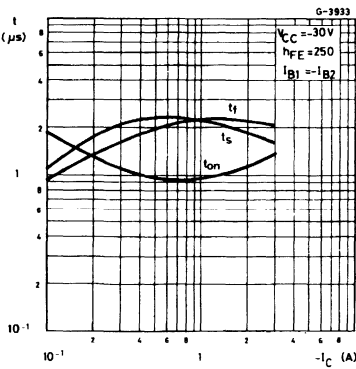



POWER DARLINGTONS

DESCRIPTION

The BDX 85, BDX 85A, BDX 85B and BDX 85C are silicon epitaxial-base NPN power transistors in monolithic Darlington configuration and are mounted in Jedec TO-3 metal case. They are intended for use in power linear and switching applications.

The complementary PNP types are the BDX 86, BDX 86A, BDX 86B and BDX 86C respectively.

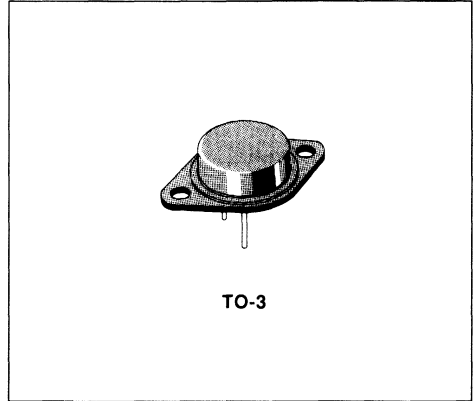

INTERNAL SCHEMATIC DIAGRAMS

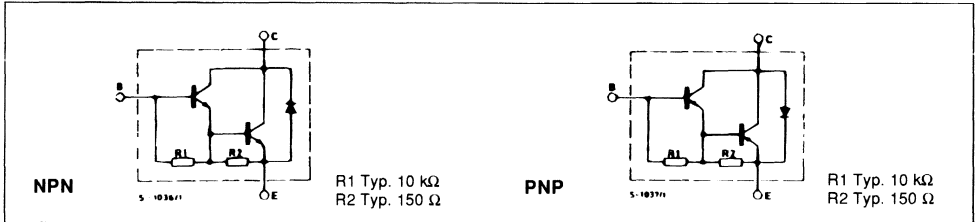

ABSOLUTE MAXIMUM RATINGS

Symbol	Parameter	NPN PNP*	Value				Unit
			BDX85 BDX86	BDX85A BDX86A	BDX85B BDX86B	BDX85C BDX86C	
V _{CB0}	Collector-base Voltage (I _E = 0)		45	60	80	100	V
V _{CE0}	Collector-emitter Voltage (I _B = 0)		45	60	80	100	V
V _{EBO}	Emitter-base Voltage (I _C = 0)		5				V
I _C	Collector Current		10				A
I _{CM}	Collector Peak Current (repetitive)		15				A
I _B	Base Current		0.1				A
P _{tot}	Total Power Dissipation at T _{case} ≤ 25 °C		100				W
T _{stg}	Storage Temperature		- 65 to 200				°C
T _j	Junction Temperature		200				°C

* For PNP types voltage and current values are negative.

THERMAL DATA

$R_{th\ j-case}$	Thermal Resistance Junction-case	Max	1.75	°C/W
------------------	----------------------------------	-----	------	------

ELECTRICAL CHARACTERISTICS ($T_{case} = 25\text{ °C}$ unless otherwise specified)

Symbol	Parameter	Test Conditions	Min.	Typ.	Max.	Unit
I_{CBO}	Collector Cutoff Current ($I_E = 0$)	for BDX85/86 $V_{CB} = 45\text{ V}$ for BDX85A/86A $V_{CB} = 60\text{ V}$ for BDX85B/86B $V_{CB} = 80\text{ V}$ for BDX85C/86C $V_{CB} = 100\text{ V}$ $T_{case} = 150\text{ °C}$ for BDX85/86 $V_{CB} = 45\text{ V}$ for BDX85A/86A $V_{CB} = 60\text{ V}$ for BDX85B/86B $V_{CB} = 80\text{ V}$ for BDX85C/86C $V_{CB} = 100\text{ V}$			500 500 500 500 5 5 5 5	μA μA μA μA mA mA mA mA
I_{CEO}	Collector Cutoff Current ($I_B = 0$)	for BDX85/86 $V_{CE} = 22\text{ V}$ for BDX85A/86A $V_{CE} = 30\text{ V}$ for BDX85B/86B $V_{CE} = 40\text{ V}$ for BDX85C/86C $V_{CE} = 50\text{ V}$			1 1 1 1	mA mA mA mA
I_{EBO}	Emitter Cutoff Current ($I_C = 0$)	$V_{EB} = 5\text{ V}$			2	mA
$V_{CEO(sus)*}$	Collector-emitter Sustaining Voltage ($I_B = 0$)	$I_C = 100\text{ mA}$ for BDX85/86 for BDX85A/86A for BDX85B/86B for BDX85C/86C	45 60 80 100			V V V V
$V_{CE(sat)*}$	Collector-emitter Saturation Voltage	$I_C = 4\text{ A}$ $I_B = 16\text{ mA}$ $I_C = 8\text{ A}$ $I_B = 40\text{ mA}$			2 4	V V
$V_{BE(sat)*}$	Base-emitter Saturation Voltage	$I_C = 8\text{ A}$ $I_B = 80\text{ mA}$			4	V
V_{BE}^*	Base-emitter Voltage	$I_C = 4\text{ A}$ $V_{CE} = 3\text{ V}$			2.8	V
h_{FE}^*	DC Current Gain	$I_C = 3\text{ A}$ $V_{CE} = 3\text{ V}$ $I_C = 4\text{ A}$ $V_{CE} = 3\text{ V}$ $I_C = 8\text{ A}$ $V_{CE} = 4\text{ V}$	1000 750 200		18000	
V_F	Parallel-diode Forward Voltage	$I_F = 3\text{ A}$ $I_F = 8\text{ A}$		2.5	1.8	V V
h_{fe}	Small Signal Current Gain	$I_C = 3\text{ A}$ $V_{CE} = 3\text{ V}$ $f = 1\text{ MHz}$		10		

* Pulsed : pulse duration = 300 ms, duty cycle = 1.5 %.
For PNP type voltage and current values are negative.

Safe Operating Areas (for **BDX85, BDX85A, BDX86, BDX86A**).

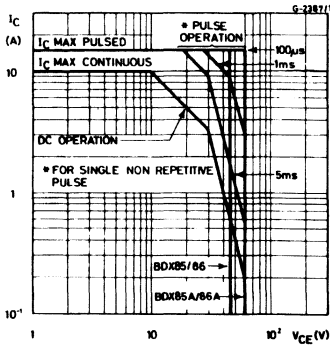

Safe Operating Areas (for **BDX85B, BDX85C, BDX86B, BDX86C**).

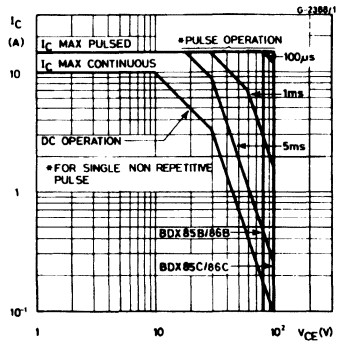

DC Current Gain (NPN types).

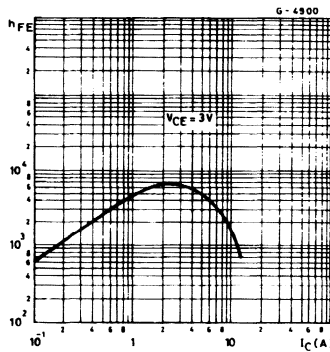

DC Current Gain (PNP types).

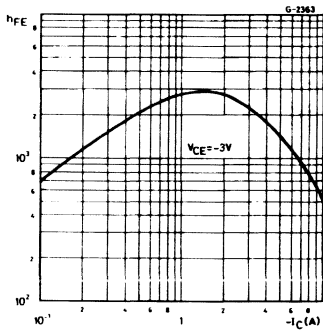

DC Transconductance (NPN types).

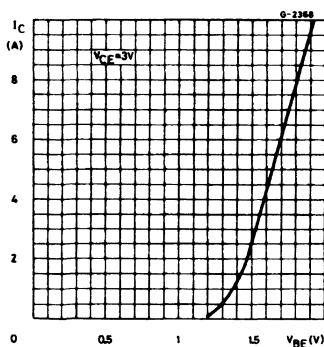

DC Transconductance (PNP types).

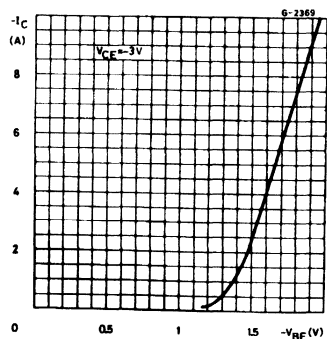

Collector-emitter Saturation Voltage (NPN types).

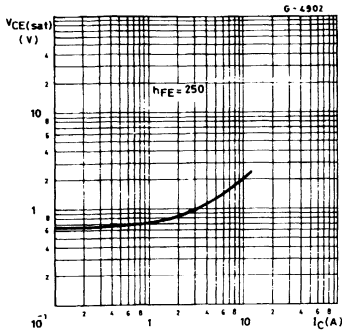

Collector-emitter Saturation Voltage (PNP types).

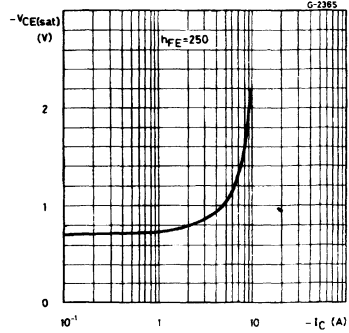

Collector-emitter Saturation Voltage (NPN types).

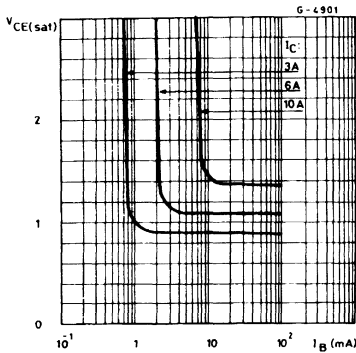

Collector-emitter Saturation Voltage (PNP types).

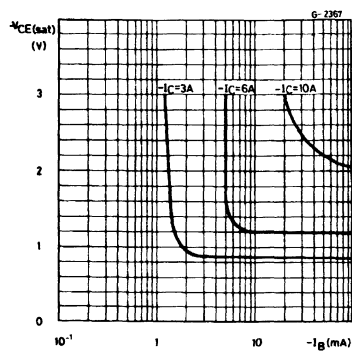

Base-emitter Saturation Voltage (NPN types).

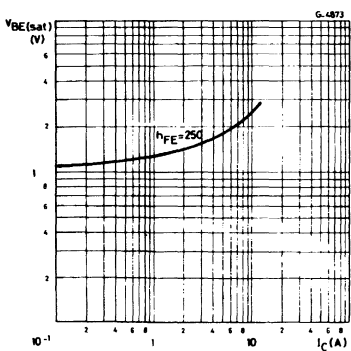

Base-emitter Saturation Voltage (PNP types).

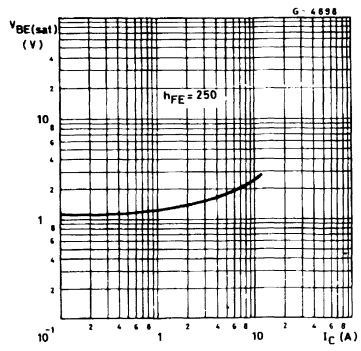

Small Signal Current Gain (NPN types).

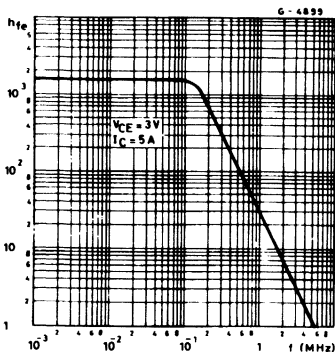

Small Signal Current Gain (PNP types).

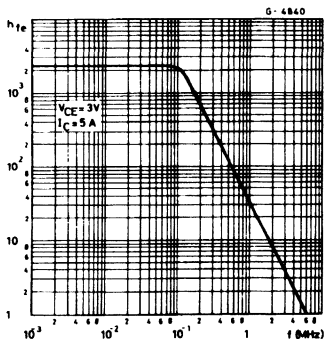

Collector-base Capacitance (NPN types).

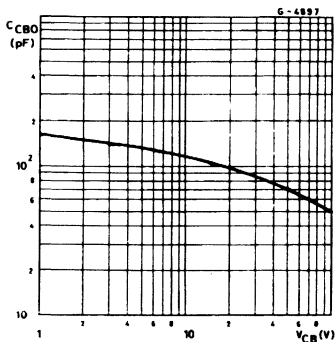

Collector-base Capacitance (PNP types).

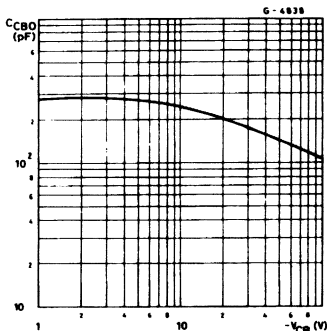

Saturated Switching Characteristics (NPN types).

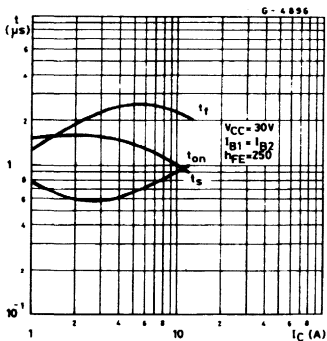

Saturated Switching Characteristics (PNP types).

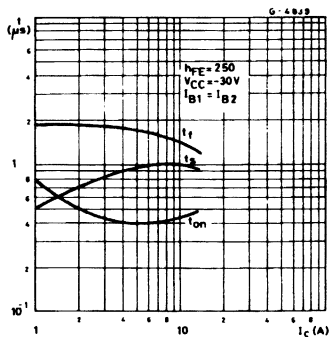



POWER DARLINGTONS

DESCRIPTION

The BDX87, BDX87A, BDX87B and BDX87C are silicon epitaxial-base NPN power transistors in monolithic Darlington configuration and are mounted in Jedec TO-3 metal case. They are intended for use in power linear and switching applications.

The complementary PNP types are the BDX88, BDX88A, BDX88B and BDX88C respectively.

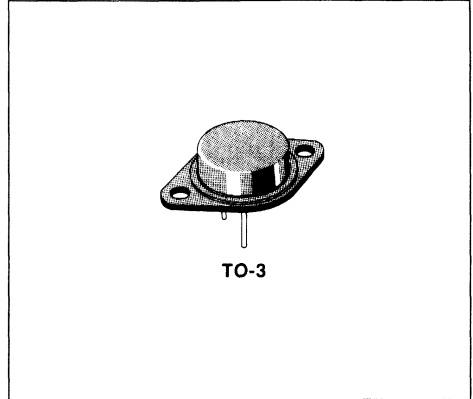

INTERNAL SCHEMATIC DIAGRAMS

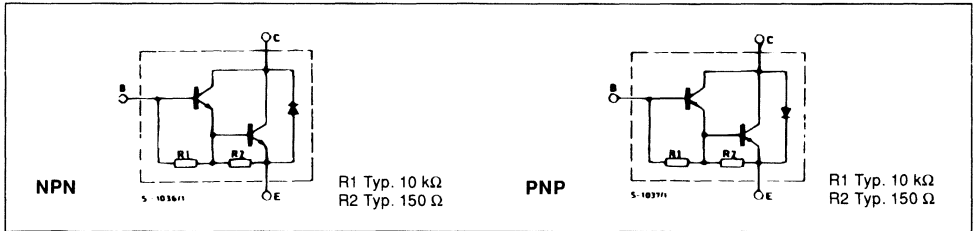

ABSOLUTE MAXIMUM RATINGS

Symbol	Parameter	NPN PNP*	Value				Unit
			BDX87 BDX88	BDX87A BDX88A	BDX87B BDX88B	BDX87C BDX88C	
V _{CB0}	Collector-base Voltage (I _E = 0)		45	60	80	100	V
V _{CEO}	Collector-emitter Voltage (I _B = 0)		45	60	80	100	V
V _{EBO}	Emitter-base Voltage (I _C = 0)		5				V
I _C	Collector Current		12				A
I _{CM}	Collector Peak Current (repetitive)		18				A
I _B	Base Current		0.2				A
P _{tot}	Total Power Dissipation at T _{case} ≤ 25 °C		120				W
T _{stg}	Storage Temperature		- 65 to 200				°C
T _J	Junction Temperature		200				°C

* For PNP types voltage and current values are negative.

THERMAL DATA

$R_{th\ j-case}$	Thermal Resistance Junction-case	Max	1.45	°C/W
------------------	----------------------------------	-----	------	------

ELECTRICAL CHARACTERISTICS ($T_{case} = 25\text{ °C}$ unless otherwise specified)

Symbol	Parameter	Test Conditions	Min.	Typ.	Max.	Unit
I_{CBO}	Collector Cutoff Current ($I_E = 0$)	for BDX87/8 $V_{CB} = 45\text{ V}$ for BDX87A/8A $V_{CB} = 60\text{ V}$ for BDX87B/8B $V_{CB} = 80\text{ V}$ for BDX87C/8C $V_{CB} = 100\text{ V}$ $T_{case} = 150\text{ °C}$ for BDX87/8 $V_{CB} = 45\text{ V}$ for BDX87A/8A $V_{CB} = 60\text{ V}$ for BDX87B/8B $V_{CB} = 80\text{ V}$ for BDX87C/8C $V_{CB} = 100\text{ V}$			500 500 500 500 5 5 5 5	μA μA μA μA mA mA mA mA
I_{CEO}	Collector Cutoff Current ($I_B = 0$)	for BDX87/8 $V_{CE} = 22\text{ V}$ for BDX87A/8A $V_{CE} = 30\text{ V}$ for BDX87B/8B $V_{CE} = 40\text{ V}$ for BDX87C/8C $V_{CE} = 50\text{ V}$			1 1 1 1	mA mA mA mA
I_{EBO}	Emitter Cutoff Current ($I_C = 0$)	$V_{EB} = 5\text{ V}$			1	mA
$V_{CEO(sus)}^*$	Collector-emitter Sustaining Voltage ($I_B = 0$)	$I_C = 100\text{ mA}$ for BDX87/88 for BDX87A/88A for BDX87B/88B for BDX87C/88C	45 60 80 100			V V V V
$V_{CE(sat)}^*$	Collector-emitter Saturation Voltage	$I_C = 6\text{ A}$ $I_B = 24\text{ mA}$ $I_C = 12\text{ A}$ $I_B = 120\text{ mA}$			2 3	V V
$V_{BE(sat)}^*$	Base-emitter Saturation Voltage	$I_C = 12\text{ A}$ $I_B = 120\text{ mA}$			4	V
V_{BE}^*	Base-emitter Voltage	$I_C = 6\text{ A}$ $V_{CE} = 3\text{ V}$			2.8	V
h_{FE}^*	DC Current Gain	$I_C = 5\text{ A}$ $V_{CE} = 3\text{ V}$ $I_C = 6\text{ A}$ $V_{CE} = 3\text{ V}$ $I_C = 12\text{ A}$ $V_{CE} = 3\text{ V}$	1000 750 100		18000	
V_F	Parallel-diode Forward Voltage	$I_F = 3\text{ A}$ $I_F = 8\text{ A}$		2.5	1.8	V V
h_{fe}	Small Signal Current Gain	$I_C = 5\text{ A}$ $V_{CE} = 3\text{ V}$ $f = 1\text{ MHz}$		25		

* Pulsed : pulse duration = 300 μs , duty cycle = 1.5%.
For PNP type voltage and current values are negative.

Safe Operating Areas (for BDX87, BDX87A, BDX88, BDX88A).

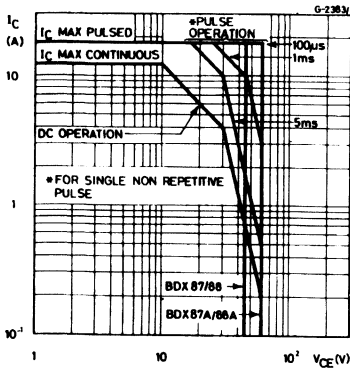

Safe Operating Areas (for BDX87A, BDX87C, BDX88B, BDX88C).

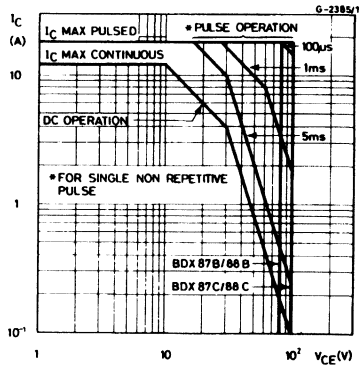

DC Current Gain (NPN types).

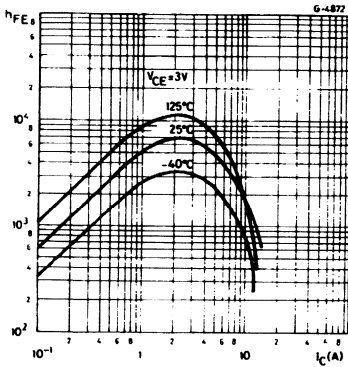

DC Current Gain (PNP types).

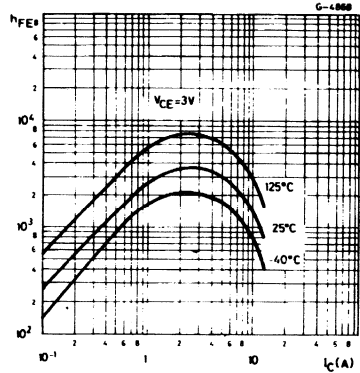

DC Transconductance (NPN types).

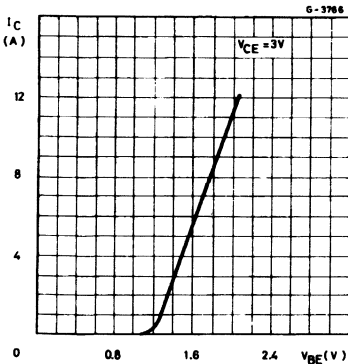

DC Transconductance (PNP types).

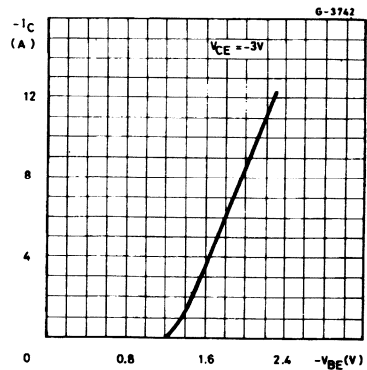

Collector-emitter Saturation Voltage (NPN types).

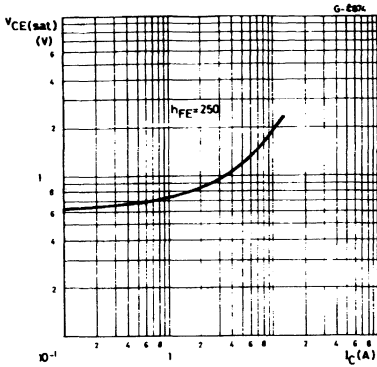

Collector-emitter Saturation Voltage (PNP types).

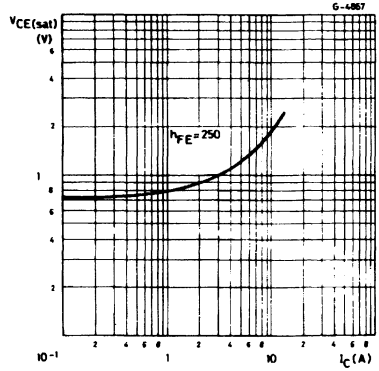

Collector-emitter Saturation Voltage (NPN types).

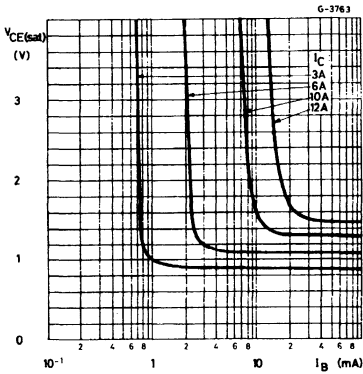

Collector-emitter Saturation Voltage (PNP types).

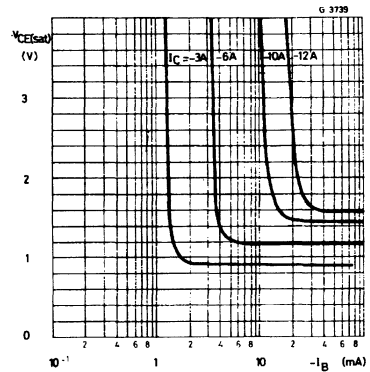

Base-emitter Saturation Voltage (NPN types).

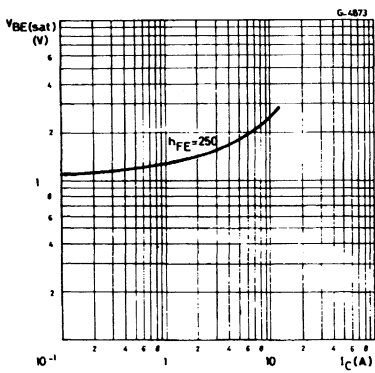

Base-emitter Saturation Voltage (PNP types).

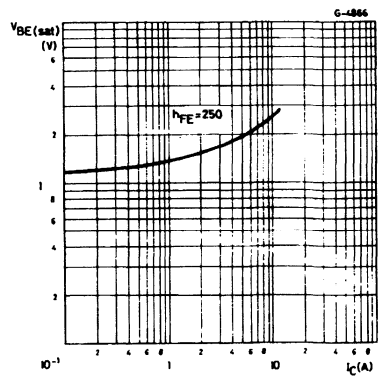

Collector-base Capacitance (NPN types).

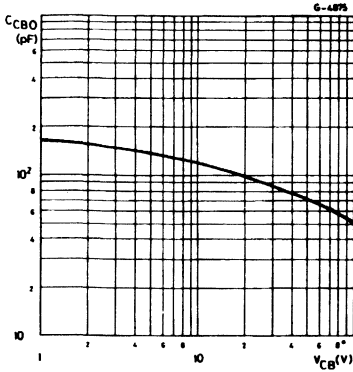

Collector-base Capacitance (PNP types).

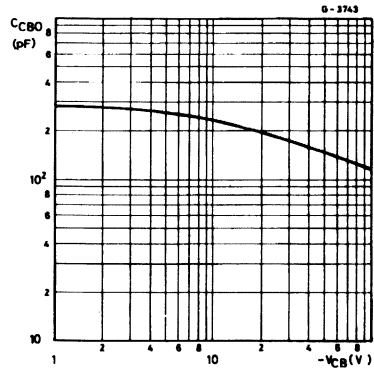

Small Signal Current Gain (NPN types).

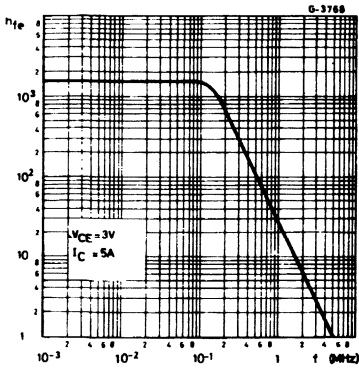

Small Signal Current Gain (PNP types).

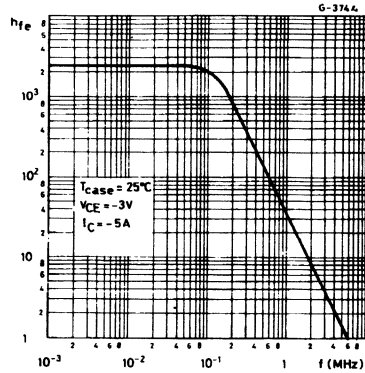

Saturated Switching Characteristics (NPN types).

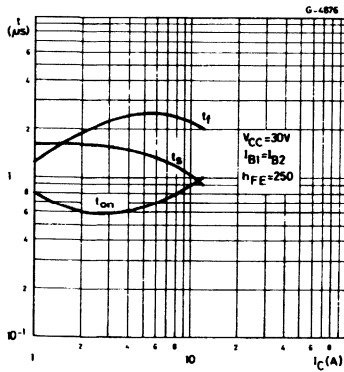

Saturated Switching Characteristics (PNP types).

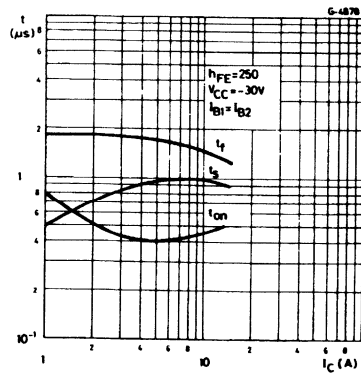

HIGH CURRENT, HIGH SPEED, HIGH POWER TRANSISTORS

DESCRIPTION

The BDY57 and BDY58 are silicon multiepitaxial planar NPN transistors in Jedec TO-3 metal case, intended for use in switching and linear applications in military and industrial equipment.

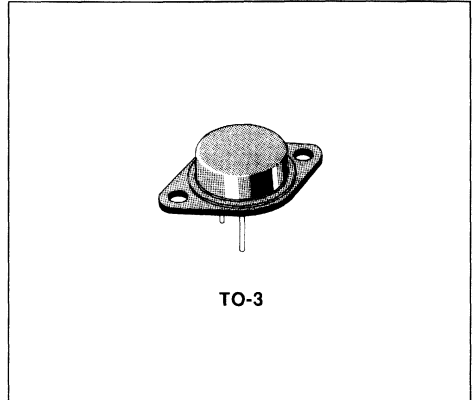
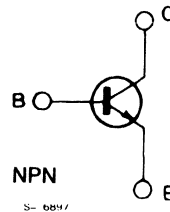
INTERNAL SCHEMATIC DIAGRAM

ABSOLUTE MAXIMUM RATINGS

Symbol	Parameter	Value		Unit
		BDY57	BDY58	
V_{CBO}	Collector-base Voltage ($I_E = 0$)	120	160	V
V_{CEO}	Collector-emitter Voltage ($I_B = 0$)	80	125	V
V_{EBO}	Emitter-base Voltage ($I_C = 0$)	10		V
I_C	Collector Current	25		A
I_B	Base Current	6		A
P_{tot}	Total Power Dissipation at $T_{case} \leq 25^\circ C$	175		W
T_{stg}	Storage Temperature	- 65 to 200		$^\circ C$
T_j	Junction Temperature	200		$^\circ C$

THERMAL DATA

$R_{th\ j-case}$	Thermal Resistance Junction-case	Max	1	°C/W
------------------	----------------------------------	-----	---	------

ELECTRICAL CHARACTERISTICS ($T_{case} = 25\text{ °C}$ unless otherwise specified)

Symbol	Parameter	Test Conditions	Min.	Typ.	Max.	Unit
I_{CBO}	Collector Cutoff Current ($I_E = 0$)	$V_{CB} = 120\text{ V}$			1	mA
I_{CER}	Collector Cutoff Current	$V_{CE} = 80\text{ V}$ $R_{BE} = 10\ \Omega$ $T_{case} = 100\text{ °C}$			10	mA
I_{EBO}	Emitter Cutoff Current ($I_C = 0$)	$V_{EB} = 10\text{ V}$			0.5	mA
$V_{CEO(sus)}^*$	Collector-emitter Sustaining Voltage	$I_C = 100\text{ mA}$ for BDY57 for BDY58	80 125			V V
$V_{(BR)CBO}^*$	Collector-base Breakdown Voltage	$I_C = 5\text{ mA}$ for BDY57 for BDY58	120 160			V V
$V_{(BR)EBO}^*$	Emitter-base Breakdown Voltage ($I_C = 0$)	$I_E = 5\text{ mA}$	10			V
$V_{CE(sat)}^*$	Collector-emitter Saturation Voltage	$I_C = 10\text{ A}$ $I_B = 1\text{ A}$		0.5	1.4	V
$V_{BE(sat)}^*$	Base-emitter Saturation Voltage	$I_C = 10\text{ A}$ $I_B = 1\text{ A}$		1.4	2	V
h_{FE}^*	DC Current Gain	$I_C = 10\text{ A}$ $V_{CE} = 4\text{ V}$ $I_C = 20\text{ A}$ $V_{CE} = 4\text{ V}$ $T_{case} = -30\text{ °C}$ $I_C = 10\text{ A}$ $V_{CE} = 4\text{ V}$	20	15	60	
f_T	Transition Frequency	$I_C = 1\text{ A}$ $V_{CE} = 15\text{ V}$ $f = 10\text{ MHz}$	7			MHz
t_{on}	Turn-on Time	$I_C = 15\text{ A}$ $I_{B1} = 1.5\text{ A}$			1	μs
t_{off}	Turn-off Time	$I_C = 15\text{ A}$ $I_{B1} = -I_{B2} = 1.5\text{ A}$			2	μs
	Clamped $E_{s/b}$ Collector Current	$V_{(clamp)} = 125\text{ V}$ $L = 500\ \mu\text{H}$	15			A

* Pulsed : pulse duration = 300 μs, duty cycle ≤ 2%.

HIGH CURRENT, HIGH SPEED TRANSISTORS

DESCRIPTION

The BDY90, BDY91, BDY92 are silicon multi-epitaxial planar NPN transistors in Jedec TO-3 metal case intended for use in switching and linear applications in military and industrial equipment.

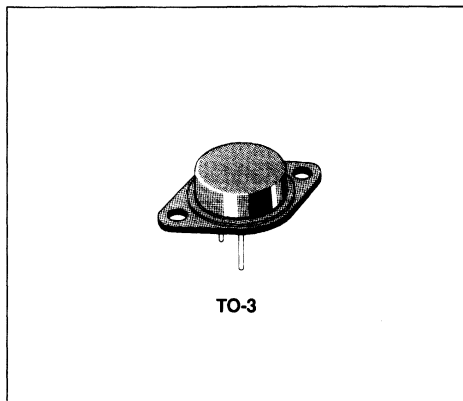

INTERNAL SCHEMATIC DIAGRAM

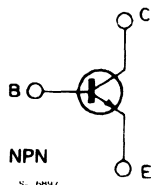

ABSOLUTE MAXIMUM RATINGS

Symbol	Parameter	Value			Unit
		BDY90	BDY91	BDY92	
V_{CBO}	Collector-base Voltage ($I_E = 0$)	120	100	80	V
V_{CEV}	Collector-emitter Voltage ($V_{BE} = -1.5$ V)	120	100	80	V
V_{CEO}	Collector-emitter Voltage ($I_B = 0$)	100	80	60	V
V_{EBO}	Emitter-base Voltage ($I_C = 0$)	6			V
I_C	Collector Current	10			A
I_{CM}	Collector Peak Current	15			A
I_B	Base Current	2			A
P_{tot}	Total Power Dissipation at $T_{case} \leq 25$ °C	60			W
T_{stg}	Storage Temperature	- 65 to 175			°C
T_j	Junction Temperature	175			°C

THERMAL DATA

$R_{th\ j-case}$	Thermal Resistance Junction-case	Max	2.5	°C/W
------------------	----------------------------------	-----	-----	------

ELECTRICAL CHARACTERISTICS ($T_{case} = 25\text{ °C}$ unless otherwise specified)

Symbol	Parameter	Test Conditions	Min.	Typ.	Max.	Unit
I_{CBO}	Collector Cutoff Current ($I_E = 0$)	$V_{CE} = V_{CBO}$			1	mA
I_{CEV}	Collector Cutoff Current ($V_{BE} = -1.5\text{ V}$)	$V_{CE} = V_{CEV}$ $T_{case} = 150\text{ °C}$ $V_{CE} = V_{CEV}$			1	mA
					3	mA
I_{EBO}	Emitter Cutoff Current ($I_C = 0$)	$V_{EB} = 6\text{ V}$			1	mA
$V_{CEO(sus)}^*$	Collector-emitter Sustaining Voltage ($I_B = 0$)	$I_C = 100\text{ mA}$ for BDY90 for BDY91 for BDY92	120 100 80			V V V
$V_{CE(sat)}^*$	Collector-emitter Saturation Voltage	$I_C = 5\text{ A}$ $I_B = 0.5\text{ A}$ $I_C = 10\text{ A}$ $I_B = 1\text{ A}$ for BDY90 , BDY91 for BDY92			0.5	V
					1.5	V
					1	V
$V_{BE(sat)}^*$	Base-emitter Saturation Voltage	$I_C = 5\text{ A}$ $I_B = 0.5\text{ A}$ $I_C = 10\text{ A}$ $I_B = 1\text{ A}$			1.2	V
					1.5	V
h_{FE}^*	DC current Gain	$I_C = 1\text{ A}$ $V_{CE} = 2\text{ V}$ $I_C = 5\text{ A}$ $V_{CE} = 5\text{ V}$ $I_C = 10\text{ A}$ $V_{CE} = 5\text{ V}$	30		120	
			30			
			20			
f_t	Transition Frequency	$I_C = 0.5\text{ A}$ $V_{CE} = 5\text{ V}$ $f = 5\text{ MHz}$		70		MHz
t_{on}	Turn-on Time	$I_C = 5\text{ A}$ $I_{B1} = 0.5\text{ A}$ $V_{CC} = 30\text{ V}$			0.35	μs
t_s	Storage Time	$I_C = 5\text{ A}$ $I_{B1} = -I_{B2} = 0.5\text{ A}$ $V_{CC} = 30\text{ V}$			1.3	μs
t_f	Fall Time				0.2	μs

* Pulsed : pulse duration = 300μs, duty cycle ≤ 2%.

HIGH CURRENT, GENERAL PURPOSE TRANSISTOR

DESCRIPTION

The BFX 34 is a silicon epitaxial planar NPN transistor in Jedec TO-39 metal case, intended for high current applications.

Very low saturation voltage and high speed at high current levels make it ideal for power drivers, power amplifiers, switching power supplies and relay drivers inverters.

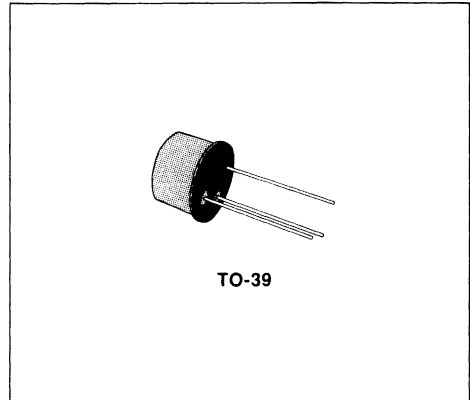

INTERNAL SCHEMATIC DIAGRAM

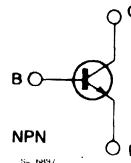

ABSOLUTE MAXIMUM RATINGS

Symbol	Parameter	Value	Unit
V_{CBO}	Collector-base Voltage ($I_E = 0$)	120	V
V_{CEO}	Collector-emitter Voltage ($I_B = 0$)	60	V
V_{EBO}	Emitter-base Voltage ($I_C = 0$)	6	V
I_C	Collector Current	5	A
P_{tot}	Total Power Dissipation at $T_{case} \leq 25^\circ C$ $T_{case} \leq 25^\circ C$	0.87	W
		5	W
T_{stg}	Storage Temperature	- 65 to 200	$^\circ C$
T_j	Junction Temperature	200	$^\circ C$

THERMAL DATA

$R_{th\ j-case}$	Thermal Resistance Junction-case	Max	35	°C/W
$R_{th\ j-amb}$	Thermal Resistance Junction-ambient	Max	200	°C/W

ELECTRICAL CHARACTERISTICS ($T_{case} = 25\text{ °C}$ unless otherwise specified)

Symbol	Parameter	Test Conditions		Min.	Typ.	Max.	Unit
I_{CES}	Collector Cutoff Current ($V_{BE} = 0$)	$V_{CE} = 60\text{ V}$			0.02	10	μA
I_{EBO}	Emitter Cutoff Current ($I_C = 0$)	$V_{EB} = 4\text{ V}$			0.05	10	μA
$V_{(BR)CBO}^*$	Collector-base Breakdown Voltage ($I_E = 0$)	$I_C = 5\text{ mA}$		120			V
$V_{CEO(sus)}^*$	Collector-emitter Sustaining Voltage ($I_B = 0$)	$I_C = 100\text{ mA}$		60			V
V_{EBO}^*	Emitter-base Voltage ($I_C = 0$)	$I_E = 1\text{ mA}$		6			V
$V_{CE(sat)}^*$	Collector-emitter Saturation Voltage	$I_C = 5\text{ A}$	$I_B = 0.5\text{ A}$		0.4	1	V
$V_{BE(sat)}^*$	Base-emitter Saturation Voltage	$I_C = 5\text{ A}$	$I_B = -0.5\text{ mA}$		1.3	1.6	V
h_{FE}^*	DC Current Gain	$I_C = 1\text{ A}$ $I_C = 1.5\text{ A}$ $I_C = 2\text{ A}$	$V_{CE} = 2\text{ V}$ $V_{CE} = 0.6\text{ V}$ $V_{CE} = 2\text{ V}$	40	100 75 80	150	
f_T	Transition Frequency	$I_C = 0.5\text{ A}$ $f = 20\text{ MHz}$	$V_{CE} = 5\text{ V}$	70	100		MHz
CEBO	Emitter-base Capacitance	$I_C = 0$ $f = 1\text{ MHz}$	$V_{EB} = 0.5\text{ V}$		300	500	pF
C_{CBO}	Collector-base Capacitance	$I_E = 0$ $f = 1\text{ MHz}$	$V_{CB} = 10\text{ V}$		40	100	pF
t_{on}	Turn-on Time	$I_C = -0.5\text{ A}$	$V_{CC} = -20\text{ V}$		0.6	0.25	μs
t_{off}	Turn-off Time	$I_{B1} = -I_{B2} = -50\text{ mA}$			0.6		1.2

* Pulsed : pulse duration = 300 μs , duty cycle = 1.5%.

Safe Operating Areas.

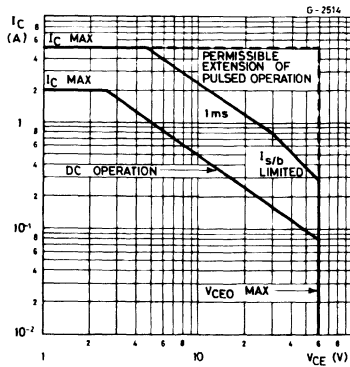

DC Current Gain.

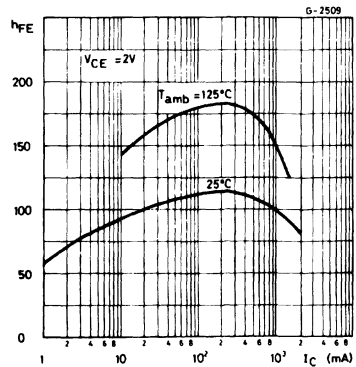

Output Characteristics.

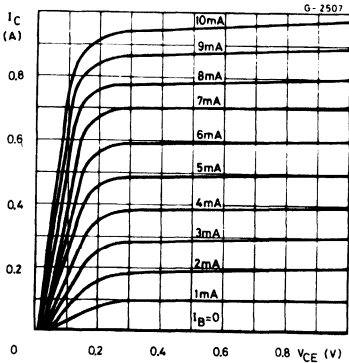

Output Characteristics.

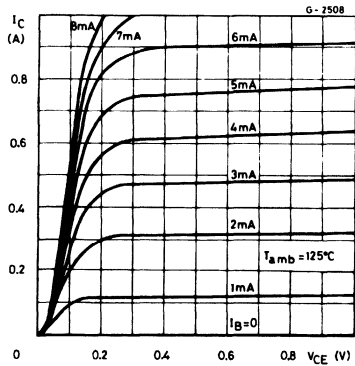

Collector-emitter Saturation Voltage.

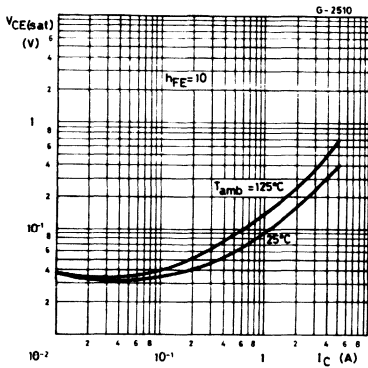

Base-emitter Saturation Voltage.

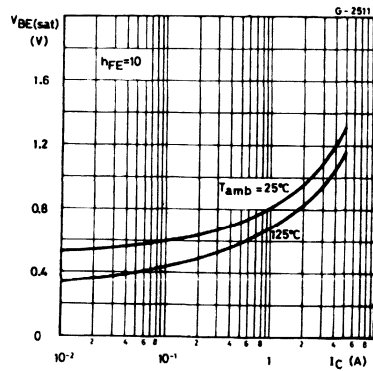

Small Signal Current Gain.

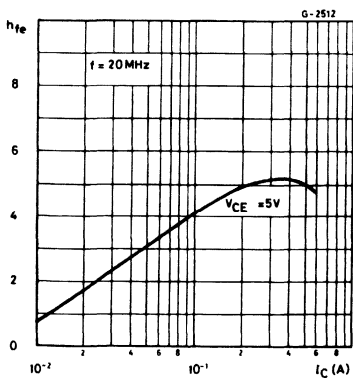

Emitter-base and Collector-base Capacitances.

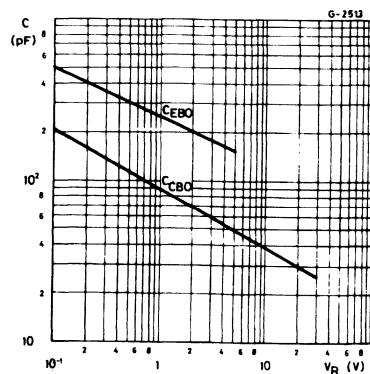

HIGH CURRENT, GENERAL PURPOSE TRANSISTOR

DESCRIPTION

The BSS44 is a silicon epitaxial planar PNP transistor in Jedec TO-39 metal case. It is used for high-current switching and power amplifier applications up to 5A.

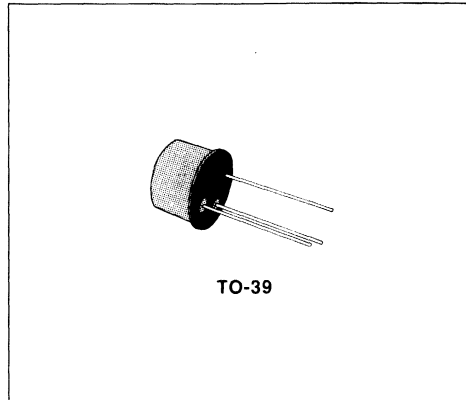

INTERNAL SCHEMATIC DIAGRAM

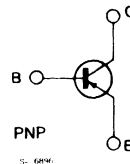

ABSOLUTE MAXIMUM RATINGS

Symbol	Parameter	Value	Unit
V_{CBO}	Collector-base Voltage ($I_E = 0$)	- 65	V
V_{CEO}	Collector-emitter Voltage ($I_B = 0$)	- 60	V
V_{EBO}	Emitter-base Voltage ($I_C = 0$)	- 6	V
I_C	Collector Current	- 5	A
P_{tot}	Total Power Dissipation at $T_{amb} \leq 25^\circ\text{C}$ $T_{case} \leq 25^\circ\text{C}$	0.87	W
		5	W
T_{stg}	Storage Temperature	- 65 to 200	$^\circ\text{C}$
T_j	Junction Temperature	200	$^\circ\text{C}$

THERMAL DATA

$R_{th\ j-case}$	Thermal Resistance Junction-case	Max	35	°C/W
$R_{th\ j-amb}$	Thermal Resistance Junction-ambient	Max	200	°C/W

ELECTRICAL CHARACTERISTICS ($T_{case} = 25\text{ °C}$ unless otherwise specified)

Symbol	Parameter	Test Conditions		Min.	Typ.	Max.	Unit
I_{CES}	Collector Cutoff Current ($I_E = 0$)	$V_{CE} = -60\text{ V}$				-0.5	μA
$V_{(BR)CBO}$	Collector-base Breakdown Voltage ($I_E = 0$)	$I_C = -1\text{ mA}$		-65			V
$V_{CEO(sus)}^*$	Collector-emitter Sustaining Voltage ($I_B = 0$)	$I_C = -50\text{ mA}$		-60			V
V_{EBO}^*	Emitter-base Voltage ($I_C = 0$)	$I_E = -1\text{ mA}$		-6			V
$V_{CE(sat)}^*$	Collector-emitter Saturation Voltage	$I_C = -0.5\text{ A}$	$I_B = -50\text{ mA}$		-0.1		V
		$I_C = -5\text{ A}$	$I_B = -0.5\text{ A}$		-0.4	-1	V
$V_{BE(sat)}^*$	Base-emitter Saturation Voltage	$I_C = -0.5\text{ A}$	$I_B = -50\text{ mA}$		-0.8		V
		$I_C = -5\text{ A}$	$I_B = -0.5\text{ mA}$		-1.1	-1.6	V
h_{FE}^*	DC Current Gain	$I_C = -0.5\text{ A}$	$V_{CE} = -2\text{ V}$	30			
		$I_C = -2\text{ A}$	$V_{CE} = -2\text{ V}$	40	70		
		$I_C = -5\text{ A}$	$V_{CE} = -2\text{ V}$		45		
f_T	Transition Frequency	$I_C = -0.5\text{ A}$	$V_{CE} = -5\text{ V}$		80		MHz
C_{CBO}	Collector-base Capacitance	$I_E = 0$ $f = 1\text{ MHz}$	$V_{CB} = -10\text{ V}$			100	pF
t_{on}	Turn-on Time	$I_C = -0.5\text{ A}$	$V_{CC} = -20\text{ V}$		0.065		μs
t_{off}	Turn-off Time	$I_{B1} = -I_{B2}$	$= -50\text{ mA}$		0.45		μs

* Pulsed : pulse duration = 300 μs , duty cycle = 1.5 %.

Safe Operating Areas.

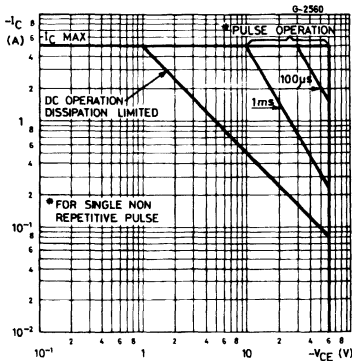

DC Current Gain.

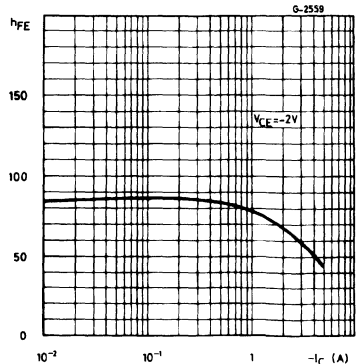

Collector-emitter Saturation Voltage.

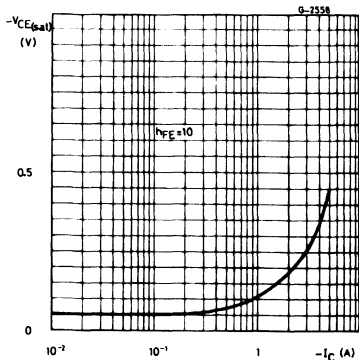

Base-emitter Saturation Voltage.

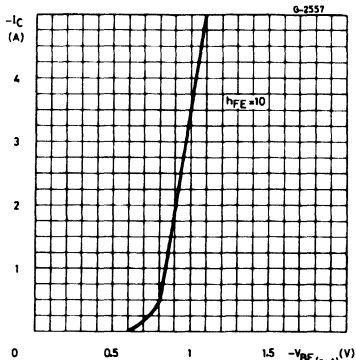

Transition Frequency.

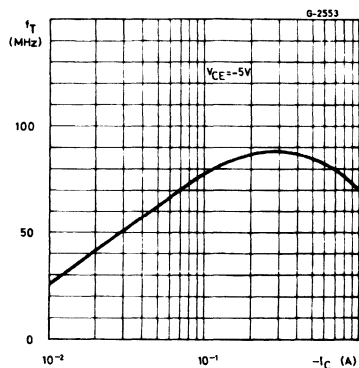

Collector-base Capacitance.

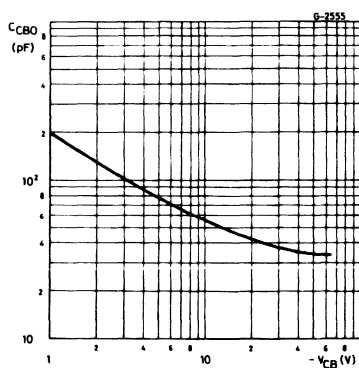

Saturated Switching Characteristics.

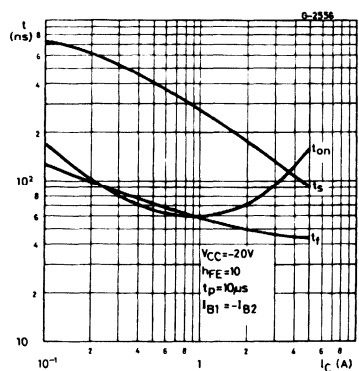

Power Rating Chart.

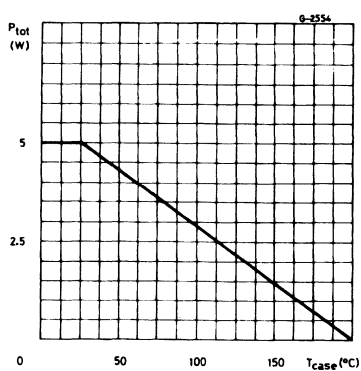

HIGH VOLTAGE SWITCH

DESCRIPTION

The BSW 67 and BSW 68 are silicon epitaxial planar NPN transistors in Jedec TO-39 metal case. They are intended for high voltage inductive load switching applications.

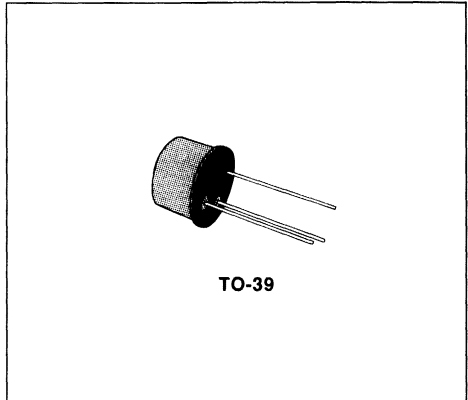

INTERNAL SCHEMATIC DIAGRAM

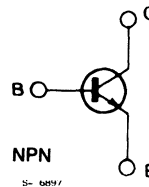

ABSOLUTE MAXIMUM RATINGS

Symbol	Parameter	Value		Unit
		BSW67	BSW68	
V_{CBO}	Collector-base Voltage ($I_E = 0$)	120	150	V
V_{CEO}	Collector-emitter Voltage ($I_B = 0$)	120	150	V
I_C	Collector Current	1.5		A
I_{CM}	Collector Peak Current	2		A
P_{Tot}	Total Power Dissipation at $T_{amb} \leq 45^\circ\text{C}$ $T_{case} \leq 25^\circ\text{C}$ $T_{case} \leq 100^\circ\text{C}$	0.7		W
		5		W
		2.85		W
T_{stg}	Storage Temperature	- 65 to 200		$^\circ\text{C}$
T_j	Junction Temperature	200		$^\circ\text{C}$

THERMAL DATA

$R_{th\ j-case}$	Thermal Resistance Junction-case	Max	35	°C/W
$R_{th\ j-amb}$	Thermal Resistance Junction-ambient	Max	220	°C/W

ELECTRICAL CHARACTERISTICS ($T_{case} = 25\ ^\circ C$ unless otherwise specified)

Symbol	Parameter	Test Conditions		Min.	Typ.	Max.	Unit
I_{CBO}	Collector Cutoff Current ($I_E = 0$)	for BSW67 $V_{CB} = 60\ V$ for BSW68 $V_{CB} = 75\ V$	$T_{case} = 150\ ^\circ C$			100 50	nA μA
$V_{(BR)CBO}$	Collector-base Breakdown Voltage ($I_E = 0$)	$I_C = 100\ \mu A$	for BSW67 for BSW68	120 150			V V
$V_{CE0(sus)}^*$	Collector-emitter Sustaining Voltage ($I_B = 0$)	$I_C = 100\ mA$	for BSW67 for BSW68	120 150			V V
V_{EBO}^*	Emitter-base Voltage ($I_C = 0$)	$I_E = 100\ \mu A$		6			V
$V_{CE(sat)}^*$	Collector-emitter Saturation Voltage	$I_C = 0.1\ A$ $I_C = 0.5\ A$ $I_C = 1\ A$	$I_B = 0.01\ A$ $I_B = 0.05\ A$ $I_B = 0.15\ A$			0.15 0.5 1	V V V
$V_{BE(sat)}^*$	Base-emitter Voltage	$I_C = 0.1\ A$ $I_C = 0.5\ A$ $I_C = 1\ A$	$I_B = 0.01\ A$ $I_B = 0.05\ A$ $I_B = 0.15\ A$			0.9 1.1 1.2	V V V
h_{FE}^*	DC Current Gain	$I_C = 0.1\ A$ $I_C = 0.5\ A$ $I_C = 1\ A$	$V_{CE} = 5\ V$ $V_{CE} = 5\ V$ $V_{CE} = 5\ V$	40 30 15			
f_T	Transition Frequency	$I_C = 100\ mA$	$V_{CE} = 20\ V$		80		MHz
C_{CBO}	Collector-base Capacitance	$I_E = 0$ $f = 1\ MHz$	$V_{CB} = 10\ V$			35	pF
t_{on}	Turn-on Time	$I_C = 0.5\ A$	$V_{CC} = 20\ V$		0.3		μs
t_{off}	Turn-off Time	$I_{B1} = -I_{B2} = 0.05\ A$			1		μs

* Pulsed : pulse duration = 300 μs , duty cycle = 1.5%.

Safe Operating Areas.

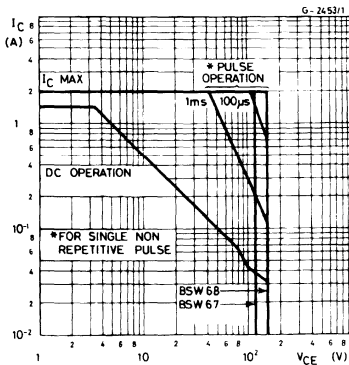

DC Current Gain.

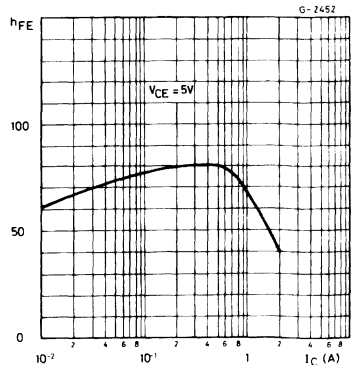

Collector-emitter Saturation Voltage.

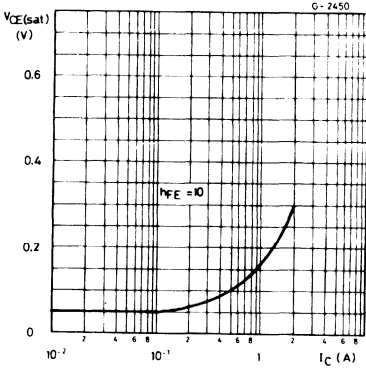

Base-emitter Saturation Voltage.

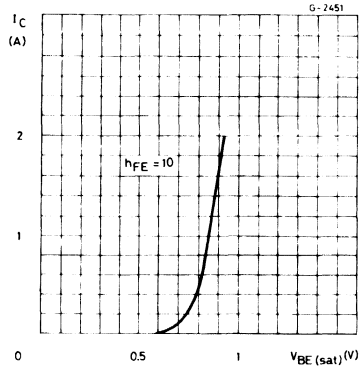

Transition Frequency.

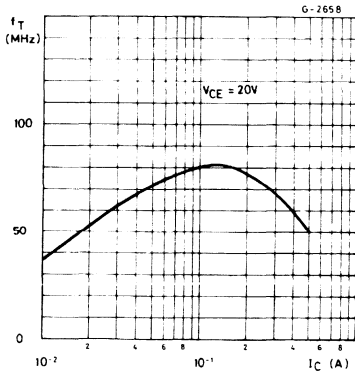

Collector-base Capacitance.

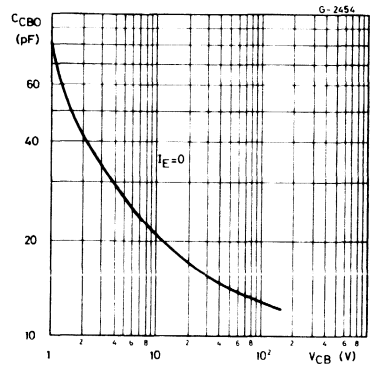

Saturated Switching Characteristics.

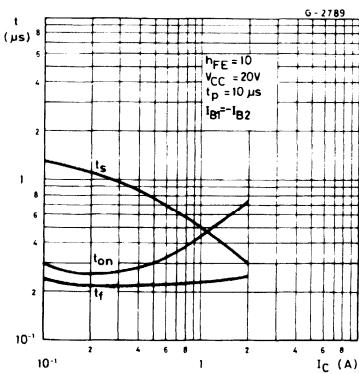

Power Rating Chart.

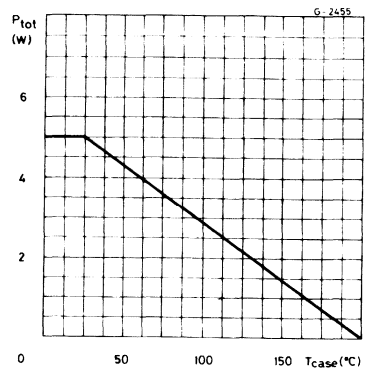

HIGH CURRENT, GENERAL PURPOSE TRANSISTOR

DESCRIPTION

The BU125 is a silicon epitaxial planar NPN transistor in Jedec TO-39 metal case. It is used in switching output and general purpose applications.

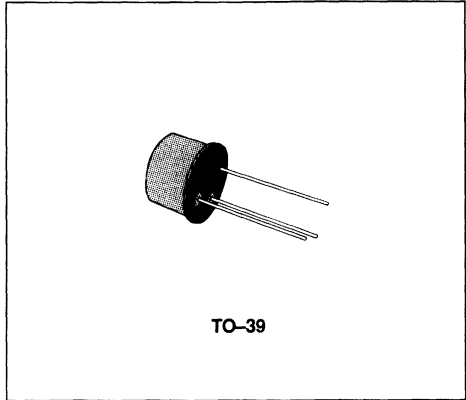

INTERNAL SCHEMATIC DIAGRAM

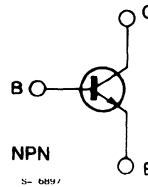

ABSOLUTE MAXIMUM RATINGS

Symbol	Parameter	Value	Unit
V_{CBO}	Collector-base Voltage ($I_E = 0$)	130	V
V_{CEO}	Collector-emitter Voltage ($I_B = 0$)	60	V
V_{EBO}	Emitter-base Voltage ($I_C = 0$)	6	V
I_C	Collector Current	7	A
P_{tot}	Total Power Dissipation at $T_{case} \leq 25\text{ }^\circ\text{C}$ $T_{amb} \leq 50\text{ }^\circ\text{C}$	1	W
		10	W
T_{stg}	Storage Temperature	- 65 to 200	$^\circ\text{C}$
T_j	Junction Temperature	200	$^\circ\text{C}$

THERMAL DATA

$R_{thj-case}$	Thermal Resistance Junction-case	Max	15	°C/W
$R_{thj-amb}$	Thermal Resistance Junction-ambient	Max	175	°C/W

ELECTRICAL CHARACTERISTICS ($T_{case} = 25\text{ °C}$ unless otherwise specified)

Symbol	Parameter	Test Conditions	Min.	Typ.	Max.	Unit
I_{CBO}	Collector Cutoff Current ($I_E = 0$)	$V_{CB} = 100\text{ V}$		0.02	10	μA
$V_{(BR)CBO}^*$	Collector-base Breakdown Voltage ($I_E = 0$)	$I_C = 1\text{ mA}$	130			V
$V_{(BR)CES}^*$	Collector-emitter Breakdown Voltage ($V_{BE} = 0$)	$I_C = 1\text{ mA}$	130			V
$V_{CE0(isus)}^*$	Collector-emitter Sustaining Voltage ($I_B = 0$)	$I_C = 50\text{ mA}$	60			V
V_{EBO}^*	Emitter-base Voltage ($I_C = 0$)	$I_E = 1\text{ mA}$	5			V
$V_{CE(sat)}^*$	Collector-emitter Saturation Voltage	$I_C = 1\text{ A}$ $I_C = 5\text{ A}$	$I_B = 0.1\text{ A}$ $I_B = 0.5\text{ A}$		0.25 1.2	V V
$V_{BE(sat)}^*$	Base-emitter Saturation Voltage	$I_C = 1\text{ A}$ $I_C = 5\text{ A}$	$I_B = 0.1\text{ A}$ $I_B = 0.5\text{ A}$	0.9 1.3	1 1.6	V V
h_{FE}^*	DC Current Gain	$I_C = 0.1\text{ A}$ $I_C = 5\text{ A}$	$V_{CE} = 2\text{ V}$ $V_{CE} = 2\text{ V}$	40 15	155 60	
f_T	Transition Frequency	$I_C = 0.5\text{ A}$	$V_{CE} = 5\text{ V}$	50		MHz
C_{CBO}	Collector-base Capacitance	$I_E = 0$ $f = 1\text{ MHz}$	$V_{CB} = 10\text{ V}$		80	pF
t_{off}	Turn-off Time	$I_C = 5\text{ A}$ $I_{B1} = -I_{B2} = 0.5\text{ A}$	$V_{CC} = 20\text{ V}$		0.65	μs

* Pulsed : pulse duration = 300 μs , duty cycle = 1.5 %

Safe Operating Areas

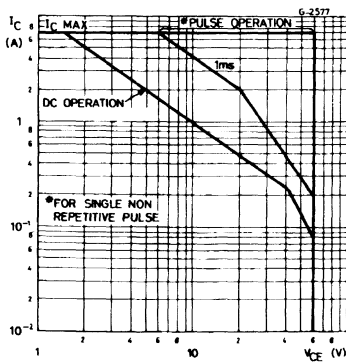

DC Current Gain

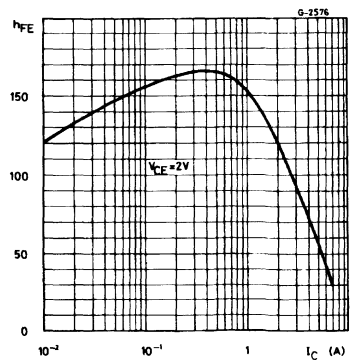

Collector-emitter Saturation Voltage

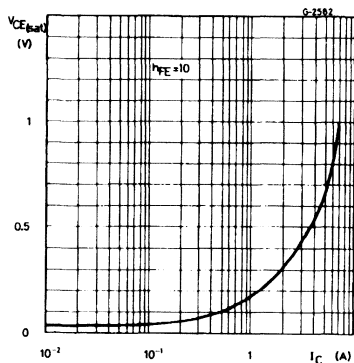

Base-emitter Saturation Voltage

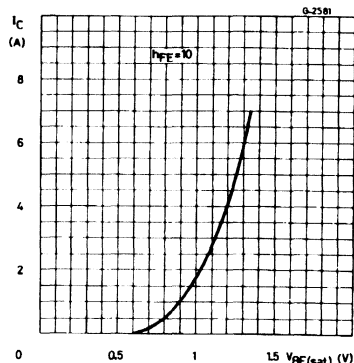

Transition Frequency

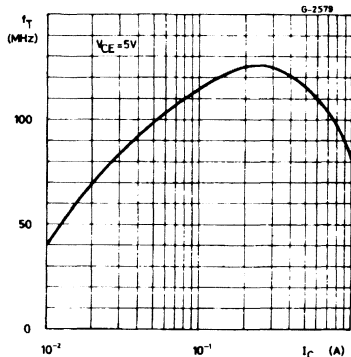

Collector-base Capacitance

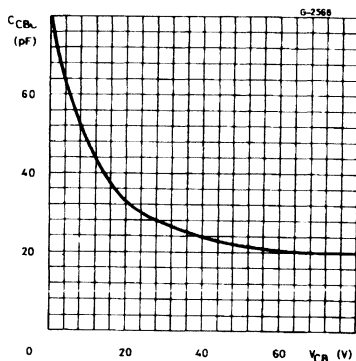

Saturated Switching Characteristics

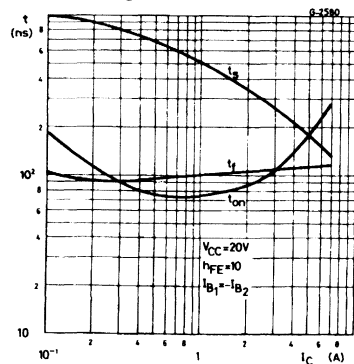

Power Rating Chart

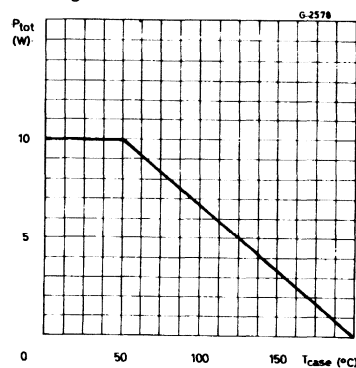

HIGH VOLTAGE POWER AMPLIFIER

DESCRIPTION

The BU125S is a silicon epitaxial planar NPN transistor in Jedec TO-39 metal case. It is intended for general purpose, linear and switching applications.

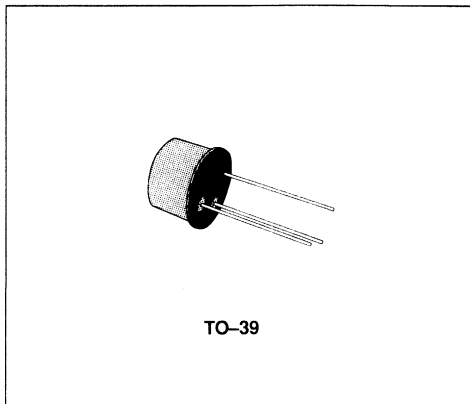

INTERNAL SCHEMATIC DIAGRAM

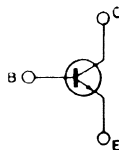

ABSOLUTE MAXIMUM RATINGS

Symbol	Parameter	Value	Unit
V_{CBO}	Collector-base Voltage ($I_E = 0$)	250	V
V_{CEV}	Collector-emitter Voltage ($V_{BE} = -1.5$ V)	250	V
V_{CEO}	Collector-emitter Voltage ($I_B = 0$)	150	V
V_{EBO}	Emitter-base Voltage ($I_C = 0$)	6	V
I_C	Collector Current	3	A
I_{CM}	Collector Peak Current (repetitive)	5	A
I_B	Base Current	0.5	A
P_{tot}	Total Power Dissipation at $T_{case} \leq 25$ °C $T_{amb} \leq 50$ °C	1	W
		10	W
T_{stg}	Storage Temperature	- 65 to 200	°C
T_j	Junction Temperature	200	°C

THERMAL DATA

$R_{thj-case}$	Thermal Resistance Junction-case	Max	15	°C/W
$R_{thj-amb}$	Thermal Resistance Junction-ambient	Max	175	°C/W

ELECTRICAL CHARACTERISTICS ($T_{case} = 25\text{ °C}$ unless otherwise specified)

Symbol	Parameter	Test Conditions		Min.	Typ.	Max.	Unit
I_{CBO}	Collector Cutoff Current ($I_E = 0$)	$V_{CB} = 200\text{ V}$				10	μA
I_{EBO}	Emitter Cutoff Current ($I_C = 0$)	$V_{EB} = 6\text{ V}$				1	mA
V_{CBO}	Collector-base Voltage ($I_E = 0$)	$I_C = 1\text{ mA}$		250			V
$V_{CE0(sus)}^*$	Collector-emitter Sustaining Voltage ($I_B = 0$)	$I_C = 20\text{ mA}$		150			V
$V_{CE(sat)}$	Collector-emitter Saturation Voltage	$I_C = 500\text{ mA}$	$I_B = 50\text{ mA}$			1.5	V
h_{FE}	DC Current Gain	$I_C = 5\text{ mA}$ $I_C = 250\text{ mA}$	$V_{CE} = 10\text{ V}$ $V_{CE} = 3\text{ V}$	30 30			
f_T	Transition Frequency	$I_C = 100\text{ mA}$ $V_{CE} = 10\text{ V}$		15			MHz
C_{CBO}	Collector-base Capacitance	$I_E = 0$ $f = 1\text{ MHz}$	$V_{CB} = 20\text{ V}$			35	pF
t_{on}	Turn-on Time	$I_C = 0.5\text{ A}$ $V_{CC} = 20\text{ V}$			0.3		μs
t_{off}	Turn-off Time	$I_{B1} = -I_{B2} = 0.05\text{ A}$			1		μs

* Pulsed : pulse duration = 300 μs , duty cycle = 1.5 %.

Safe Operating Areas.

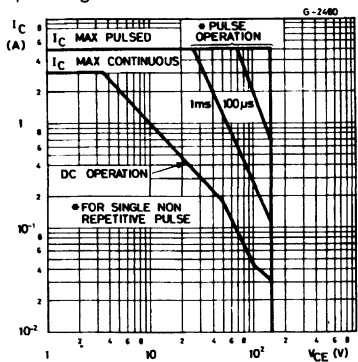

DC Current Gain.

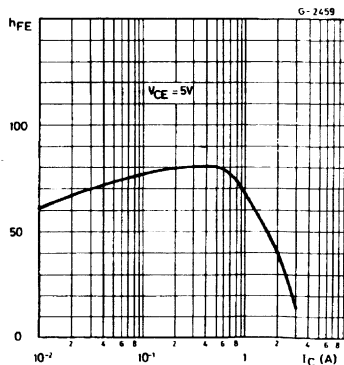

Collector-emitter Saturation Voltage.

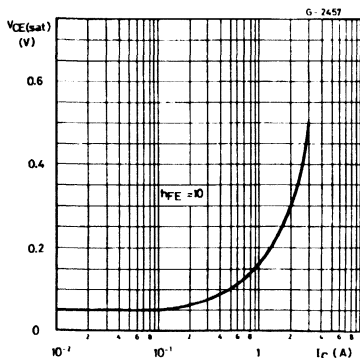

Base-emitter Saturation Voltage.

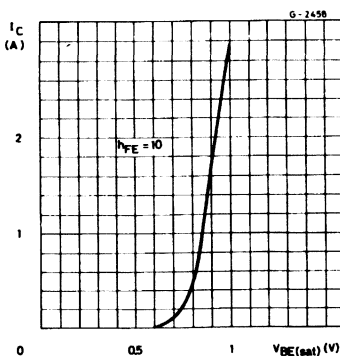

Transition Frequency.

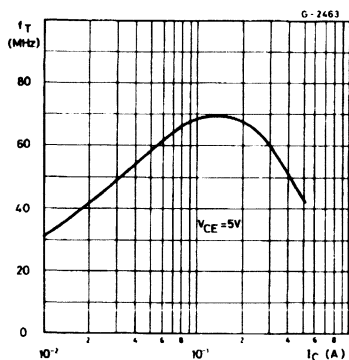

Collector-base Capacitance.

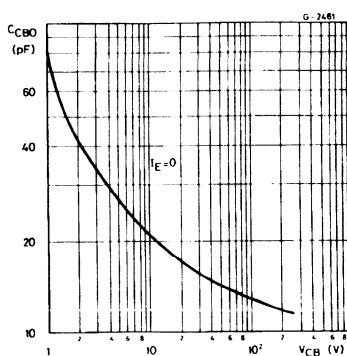

Saturated Switching Characteristics.

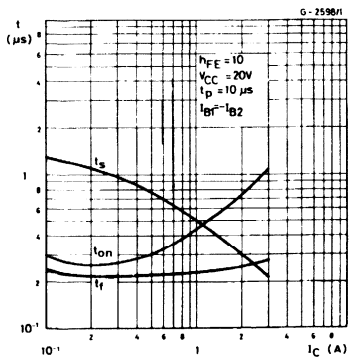

Power Rating Chart.

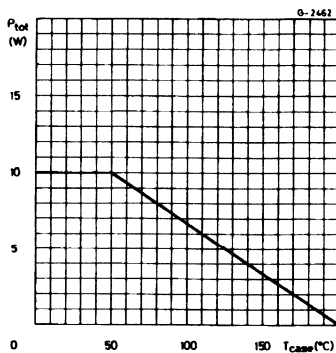

NPN SWITCHING DARLINGTONS

DESCRIPTION

Monolithic Darlingtons with integrated speed-up and damper diode, suited for TV applications.

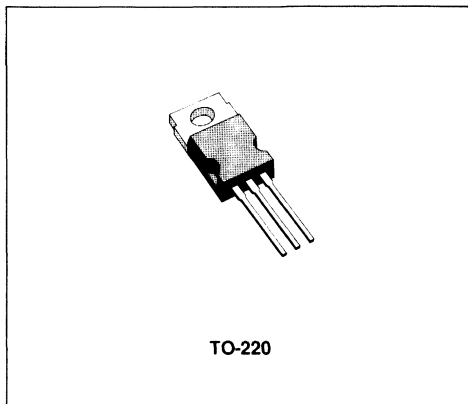

INTERNAL SCHEMATIC DIAGRAM

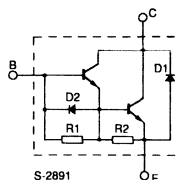

ABSOLUTE MAXIMUM RATINGS

Symbol	Parameter	Value		Unit
		BU184	BU189	
V_{CBO}	Collector-base Voltage ($I_E = 0$)	400	330	V
V_{CEX}	Collector-emitter Voltage	400	330	V
V_{CEO}	Collector-emitter Voltage ($I_B = 0$)	200	150	V
V_{EBO}	Emitter-base Voltage ($I_C = 0$)	8		V
I_C	Collector Current	8		A
I_{CM}	Collector Peak Current ($t_p < 10ms$)	15		A
I_B	Base Current	2		A
I_{BM}	Base Peak Current ($t_p < 10ms$)	4		A
P_{tot}	Total Dissipation at $T_C < 25^\circ C$	60		W
T_{stg}	Storage Temperature	- 65 to + 150		$^\circ C$
T_j	Max. Operating Junction Temperature	150		$^\circ C$

THERMAL DATA

$R_{th(j-case)}$	Thermal Resistance Junction-case	Max	2.08	$^{\circ}C/W$
------------------	----------------------------------	-----	------	---------------

ELECTRICAL CHARACTERISTICS ($T_{case} = 25^{\circ}C$ unless otherwise specified)

Symbol	Parameter	Test Conditions	Min.	Typ.	Max.	Unit
I_{CEX}	Collector Cutoff Current	$V_{CE} = V_{CEX}$ $V_{BE} = -6V$			100	μA
I_{EBO}	Emitter Cutoff Current ($I_C = 0$)	$V_{EB} = -8V$			10	mA
$V_{CE(sus)}$	Collector Emitter Sustaining Voltage	$I_C = 3A$ $L = 15mH$ for BU184 for BU189	200	150		V
$V_{CE(sat)}$	Collector-emitter Saturation Voltage	$I_C = 5A$ $I_B = 50mA$			1.5	V
$V_{BE(sat)}$	Base-emitter Saturation Voltage	$I_C = 5A$ $I_B = 50mA$			2.2	V
V_F	Diode Forward Voltage	$I_F = 4A$		1.8	2.3	V
t_s t_f	RESISTIVE LOAD Storage Time Fall Time	See Test Circuit		0.44 0.3		μs μs

* Pulse test $t_p < 300 \mu s$ $\delta < 2\%$.

TEST CIRCUIT

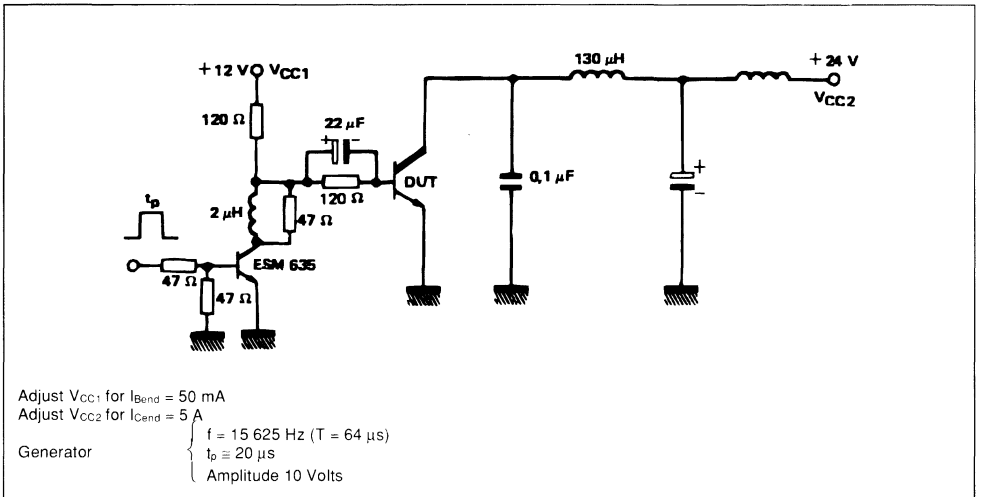

DC and Pulse Area.

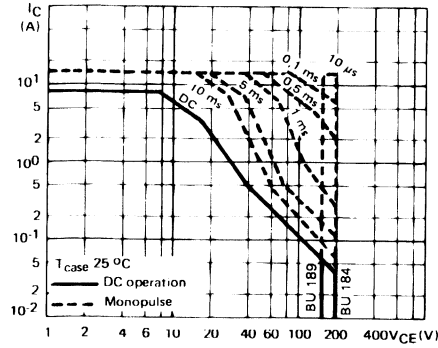

Collector-emitter Voltage vs Base-emitter Resistance.

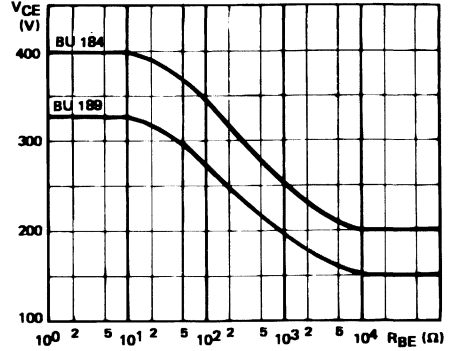

Power and IS/B Derating vs Case Temperature.

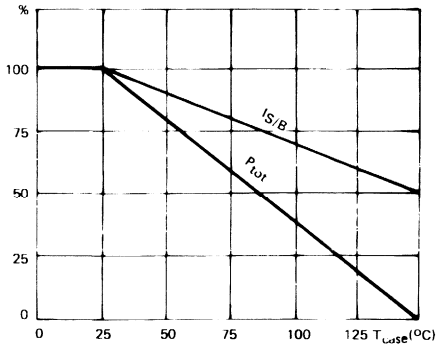

Transient Thermal Response.

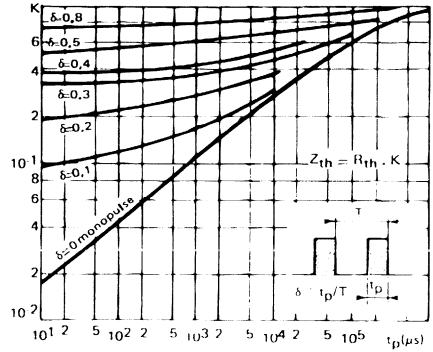

DC Current Gain.

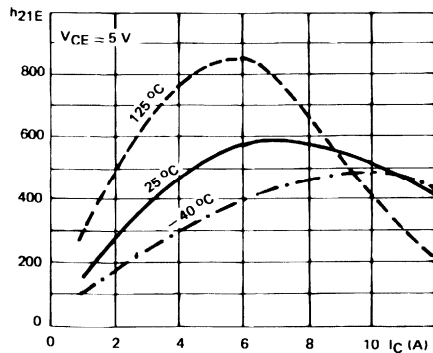

Saturation Voltage.

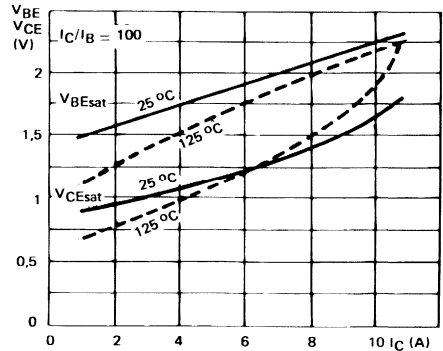

Base Characteristics.

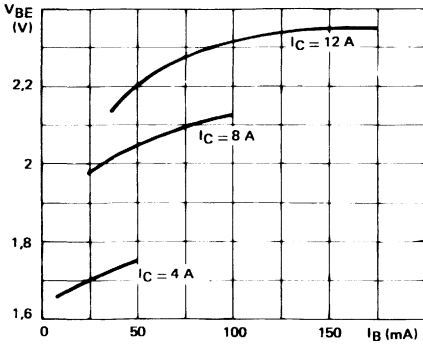

Collector Saturation Region.

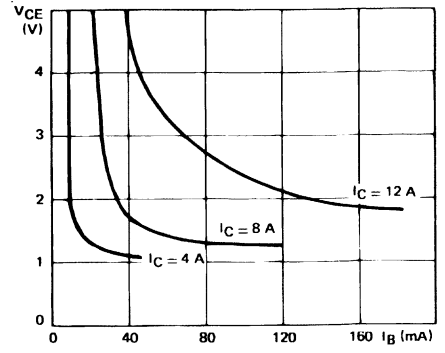



HORIZONTAL TVC DEFLECTION

- HIGH VOLTAGE
- HIGH POWER
- HIGH SWITCHING SPEED
- GOOD STABILITY
- CONSUMER
- POWER SUPPLY
- TV COLOR HORIZONTAL DEFLECTION

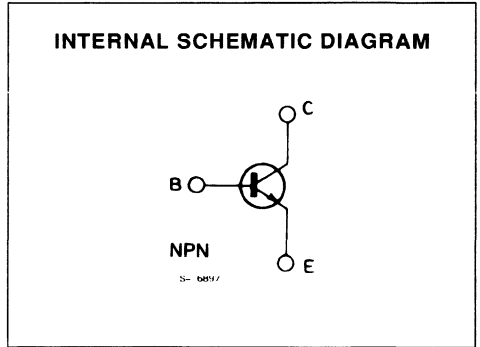
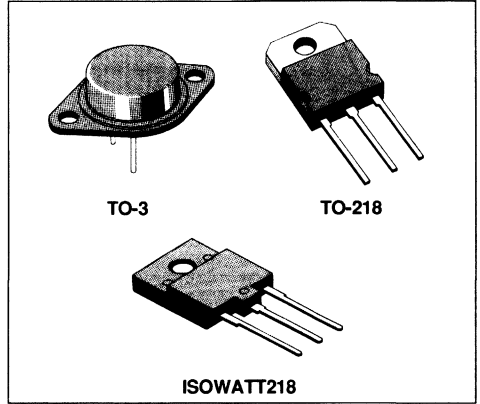

DESCRIPTION

The BU208/A, BU508/A and the BU508FI/AFI are silicon multi-epitaxial mesa NPN transistors.

They are respectively in Jedec TO-3 metal case in TO-218 plastic case and in ISOWATT218 fully isolated package.

ABSOLUTE MAXIMUM RATINGS

Symbol	Parameter	Value			Unit
		TO-3	TO-218	ISOWATT218	
V_{CES}	Collector-emitter Voltage ($V_{BE} = 0$)	1500			V
V_{CEO}	Collector-emitter Voltage ($I_B = 0$)	700			V
V_{EBO}	Emitter-base Voltage ($I_C = 0$)	10			V
I_C	Collector Current	8			A
I_{CM}	Collector Peak Current	15			A
P_{tot}	Total Dissipation at $T_c = 25^\circ\text{C}$	150	125	60	W
T_{stg}	Storage Temperature	- 65 to 175	- 65 to 150	- 65 to 150	$^\circ\text{C}$
T_J	Max. Operating Junction Temperature	175	150	150	$^\circ\text{C}$

Figure 1 : Switching Times Test Circuit on Inductive Load.

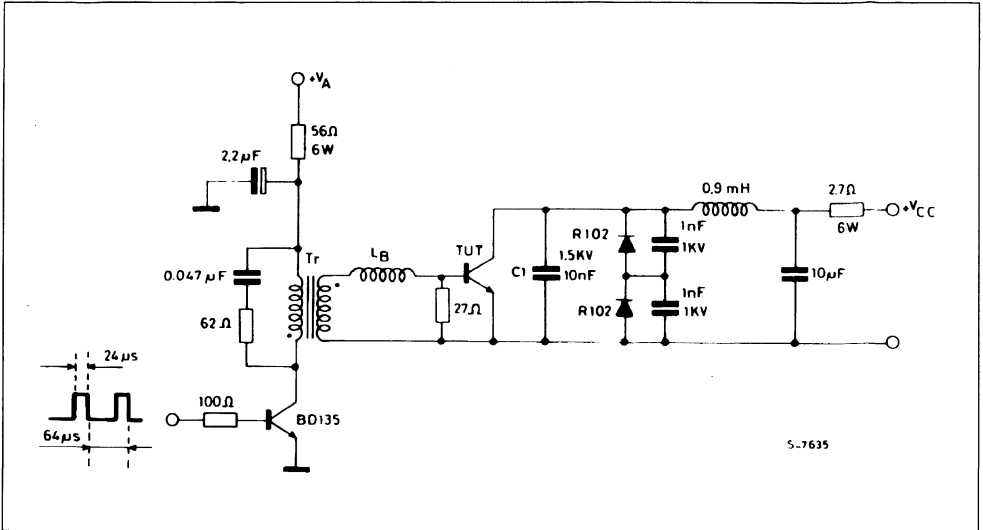

ISOWATT218 PACKAGE CHARACTERISTICS AND APPLICATION

ISOWATT218 is fully isolated to 4000V dc. Its thermal impedance, given in the data sheet, is optimised to give efficient thermal conduction together with excellent electrical isolation. The structure of the case ensures optimum distances between the pins and heatsink. These distances are in agreement with VDE and UL creepage and clearance standards. The ISOWATT218 package eliminates the need for external isolation so reducing fixing hardware.

The package is supplied with leads longer than the standard TO-218 to allow easy mounting on pcbs. Accurate moulding techniques used in manufacture

assures consistent heat spreader-to-heatsink capacitance.

ISOWATT218 thermal performance is equivalent to that of the standard part, mounted with a 0.1 mm mica washer.

The thermally conductive plastic has a higher breakdown rating and is less fragile than mica or plastic sheets.

Power derating for ISOWATT218 packages is determined by :

$$P_D = \frac{T_J - T_C}{R_{th}}$$

THERMAL IMPEDANCE OF ISOWATT218 PACKAGE

Figure 2 illustrates the elements contributing to the thermal resistance of a transistor heatsink assembly, using ISOWATT218 package.

The total thermal resistance $R_{th(tot)}$ is the sum of each of these elements.

The transient thermal impedance, Z_{th} for different pulse durations can be estimated as follows :

- 1-For a short duration power pulse of less than 1 ms :
 $Z_{th} < R_{thJ-C}$
- 2-For an intermediate power pulse of 5ms seconds :
 $Z_{th} = R_{thJ-C}$

3-For long power pulses of the order of 500ms seconds or greater :

$$Z_{th} = R_{thJ-C} + R_{thC-HS} + R_{thHS-amb}$$

It is often possible to discern these areas on transient thermal impedance curves.

Figure 2.

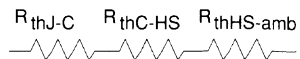

THERMAL DATA

			TO-3	TO-218	ISOWATT218	
$R_{thj-case}$	Thermal Resistance Junction-case	Max	1	1	2.08	°C/W

ELECTRICAL CHARACTERISTICS ($T_{case} = 25^{\circ}C$ unless otherwise specified)

Symbol	Parameter	Test Conditions	Min.	Typ.	Max.	Unit
I_{CES}	Collector Cutoff Current ($V_{BE} = 0$)	$V_{CE} = V_{CES}$ $T_C = 125^{\circ}C$ $V_{CE} = V_{CES}$			1 2	mA mA
I_{EBO}	Emitter Cutoff Current ($I_C = 0$)	$V_{EB} = 5V$			100	μA
$V_{CE0(sus)*}$	Collector Emitter Sustaining Voltage	$I_C = 100mA$	700			V
V_{EBO}	Emitter-base Voltage ($I_C = 0$)	$I_E = 10mA$	10			V
$V_{CE(sat)*}$	Collector-emitter Saturation Voltage	$I_C = 4.5A$ $I_B = 2A$ for BU208A/508A/508AFI for BU208/508/508FI			1 5	V V
$V_{BE(sat)*}$	Base-emitter Saturation Voltage	$I_C = 4.5A$ $I_B = 2A$			1.3	V
f_T	Transition Frequency	$I_C = 0.1A$ $V_{CE} = 5V$ $f = 5MHz$		7		MHz

INDUCTIVE LOAD

Symbol	Parameter	Test Conditions	Min.	Typ.	Max.	Unit.
t_s	Storage Time	$I_C = 4.5A$ $h_{FE} = 2.5$ $V_{CC} = 140V$		7		μs
t_f	Fall Time	$L_C = 0.9mH$ $L_B = 3\mu H$		0.55		μs

* Pulsed : pulse duration = 300 μs , duty cycle = 1.5 %.

Safe Operating Area (TO-3).

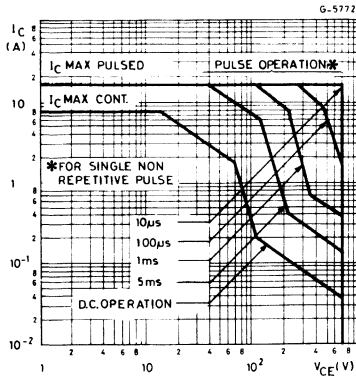

Safe Operating Area (TO-218/ISOWATT218).

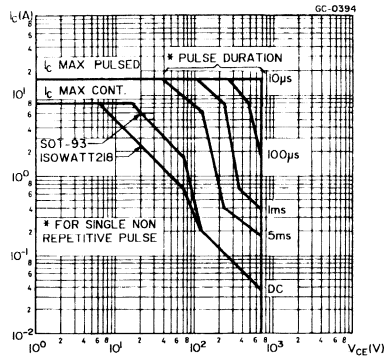

DC Current Gain.

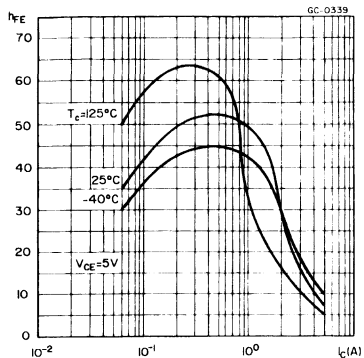

Switching Time Inductive Load.

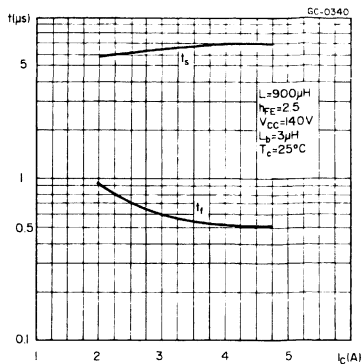

Base-emitter Saturation Voltage.

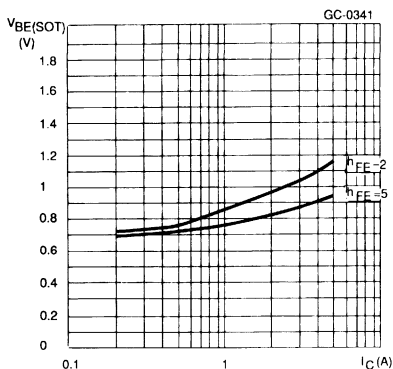

Collector-emitter Saturation Voltage.

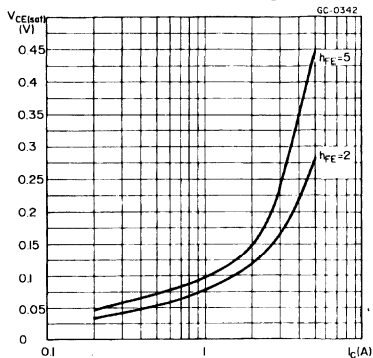

Switching Time Inductive Load.

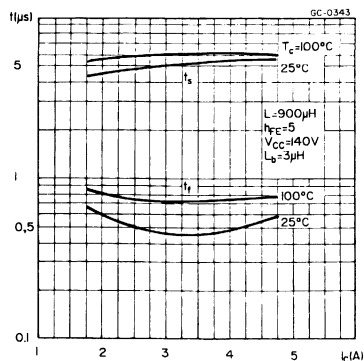



HORIZONTAL TVC DEFLECTION

- HIGH VOLTAGE
- HIGH POWER
- HIGH SWITCHING SPEED
- GOOD STABILITY

CONSUMER

- TV COLOR HORIZONTAL DEFLECTION

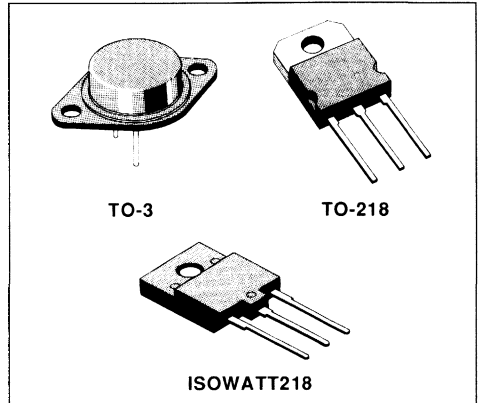

DESCRIPTION

The BU208D, BU508D and BU508DFI are silicon multiepitaxial mesa NPN transistors.

They are mounted respectively in Jedec TO-3 metal case, in TO-218 plastic case and ISOWATT218 fully isolated package.

INTERNAL SCHEMATIC DIAGRAM

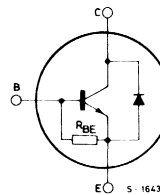

ABSOLUTE MAXIMUM RATINGS

Symbol	Parameter	Value			Unit
		TO-3	TO-218	ISOWATT218	
V_{CES}	Collector-emitter Voltage ($V_{BE} = 0$)	1500			V
V_{CEO}	Collector-emitter Voltage ($I_B = 0$)	700			V
V_{EBO}	Emitter-base Voltage ($I_C = 0$)	10			V
I_C	Collector Current	8			A
I_{CM}	Collector Peak Current	15			A
P_{tot}	Total Power Dissipation at $T_C = 25\text{ }^\circ\text{C}$	150	125	60	W
T_{stg}	Storage Temperature	- 65 to 175	- 65 to 150	- 65 to 150	$^\circ\text{C}$
T_j	Max. Operating Junction Temperature	175	150	150	$^\circ\text{C}$

THERMAL DATA

			TO-3	TO-218	ISOWATT218	
$R_{thj-case}$	Thermal Resistance Junction-case	Max	1	1	2.08	°C/W

ELECTRICAL CHARACTERISTICS ($T_{case} = 25^{\circ}C$ unless otherwise specified)

Symbol	Parameter	Test Conditions	Min.	Typ.	Max.	Unit
I_{CES}	Collector Cutoff Current ($V_{BE} = 0$)	$V_{CE} = V_{CES}$ $T_C = 125^{\circ}C$ $V_{CE} = V_{CES}$			1 2	mA mA
I_{EBO}	Emitter Cutoff Current ($I_C = 0$)	$V_{EB} = 5V$			300	mA
$V_{CE(0.1s)}^*$	Collector-emitter Sustaining Voltage	$I_C = 100mA$	700			V
$V_{CE(sat)}^*$	Collector-emitter Saturation Voltage	$I_C = 4.5A$ $I_B = 2A$			1	V
$V_{BE(sat)}^*$	Base-emitter Saturation Voltage	$I_C = 4.5A$ $I_B = 2A$			1.3	V
V_F	Diode Forward Voltage	$I_F = 4A$			2	V
f_T	Transition Frequency	$I_C = 0.1A$ $V_{CE} = 5V$ $f = 5MHz$		7		MHz

INDUCTIVE LOAD

Symbol	Parameter	Test Conditions	Min.	Typ.	Max.	Unit.
t_s	Storage Time	$I_C = 4.5A$ $h_{FE} = 2.5$ $V_{CC} = 140V$		7		μs
t_f	Fall Time	$L_C = 0.9mH$ $L_B = 3\mu H$		0.55		μs

* Pulsed : Pulse duration = 300 μs , duty cycle = 1.5%.

Safe Operating Area (TO-3).

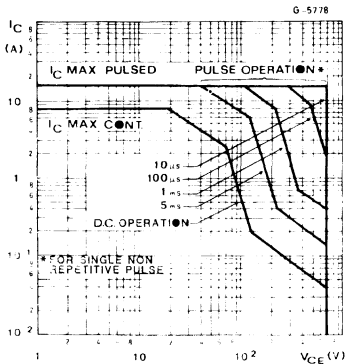

Safe Operating Area (TO-218/ISOWATT218).

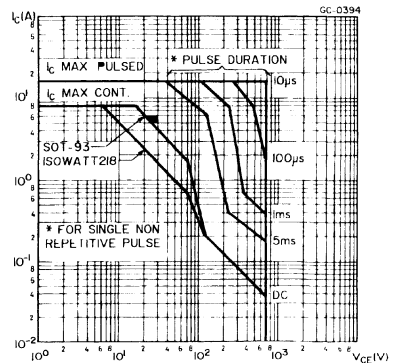

DC Current Gain.

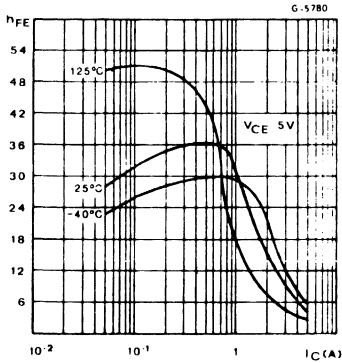

Collector Saturation Region.

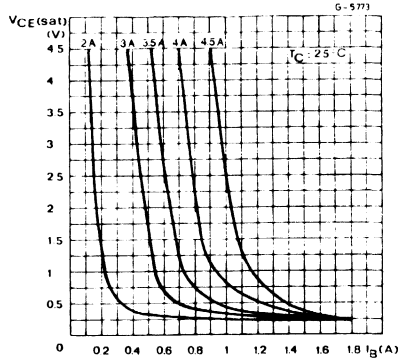

Collector-emitter Saturation Voltage.

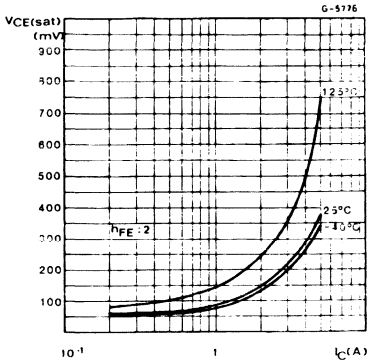

Base-emitter Saturation Voltage.

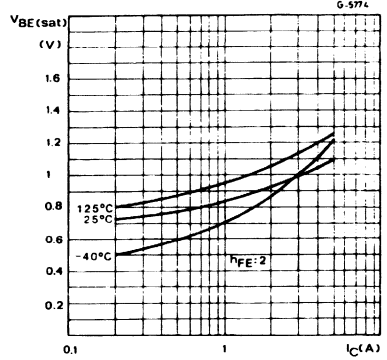

Switching Times Inductive Load (see fig. 1).

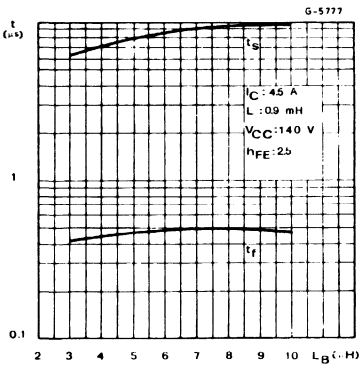

Switching Times Percentage vs. Case Temperature (see fig. 1).

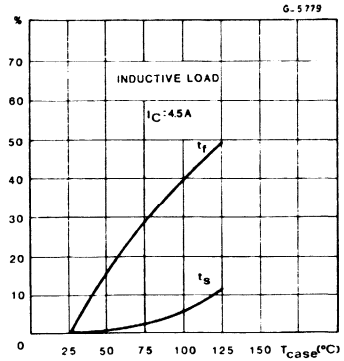

DC Current Gain.

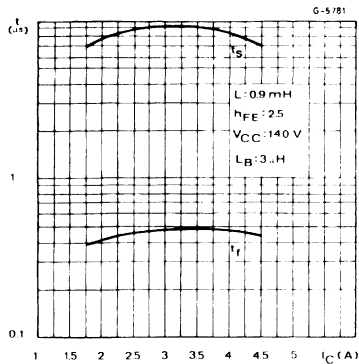
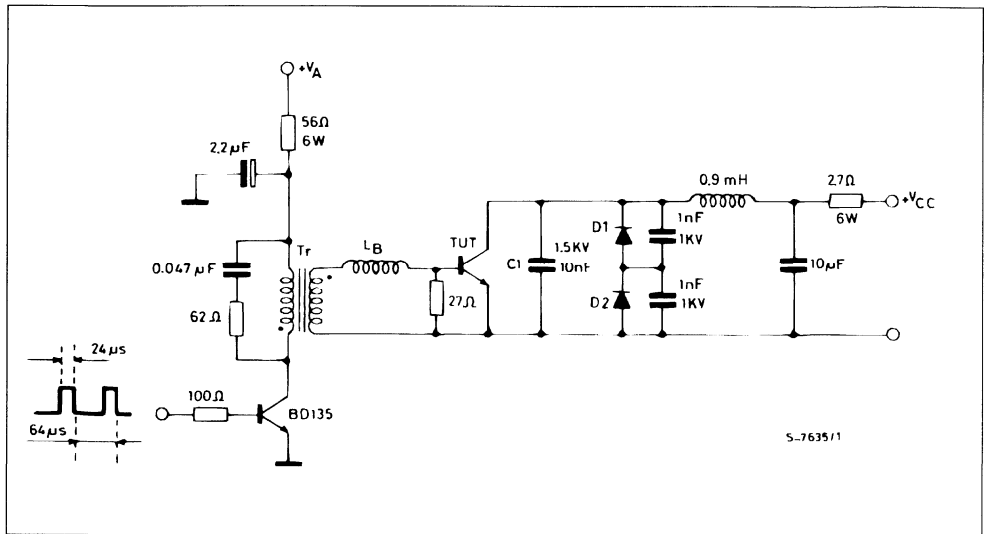

Figure 1 : Switching Times Test Circuit on Inductive Load.



ISOWATT218 PACKAGE CHARACTERISTICS AND APPLICATION

ISOWATT218 is fully isolated to 4000V dc. Its thermal impedance, given in the data sheet, is optimised to give efficient thermal conduction together with excellent electrical isolation. The structure of the case ensures optimum distances between the pins and heatsink. These distances are in agreement with VDE and UL creepage and clearance standards. The ISOWATT218 package eliminates the need for external isolation so reducing fixing hardware.

The package is supplied with leads longer than the standard TO-218 to allow easy mounting on

pcbs. Accurate moulding techniques used in manufacture assures consistent heat spreader-to-heat-sink capacitance.

ISOWATT220 thermal performance is equivalent to that of the standard part, mounted with a 0.1 mm mica washer. The thermally conductive plastic has a higher breakdown rating and is less fragile than mica or plastic sheets. Power derating for ISOWATT218 packages is determined by :

$$P_D = \frac{T_j - T_c}{R_{th}}$$

THERMAL IMPEDANCE OF ISOWATT218 PACKAGE

Figure 2 illustrates the elements contributing to the thermal resistance of a transistor heatsink assembly, using ISOWATT218 package.

The total thermal resistance $R_{th(tot)}$ is the sum of each of these elements.

The transient thermal impedance, Z_{th} for different pulse durations can be estimated as follows :

1-for a short duration power pulse less than 1ms :

$$Z_{th} < R_{thJ-C}$$

2-for an intermediate power pulse of 5ms to 50ms :

$$Z_{th} = R_{thJ-C}$$

3-for long power pulses of the order of 500ms or greater :

$$Z_{th} = R_{thJ-C} + R_{thC-HS} + R_{thHS-amb}$$

It is often possible to discern these areas on transient thermal impedance curves.

Figure 2.

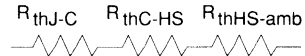

HIGH VOLTAGE SWITCH

DESCRIPTION

The BU325 is a silicon planar epitaxial NPN transistor in Jedec TO-126 plastic case. It is intended for high voltage, high current linear and switching applications.

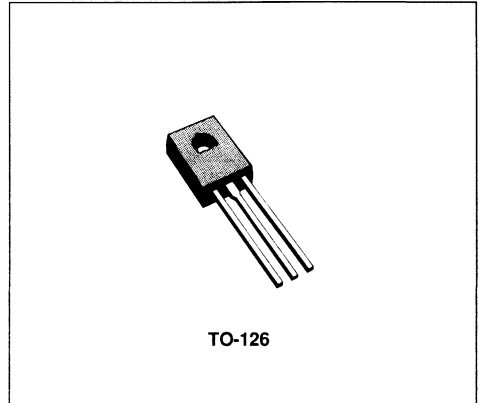

INTERNAL SCHEMATIC DIAGRAM

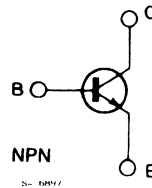

ABSOLUTE MAXIMUM RATINGS

Symbol	Parameter	Value	Unit
V_{CBO}	Collector-base Voltage ($I_E = 0$)	200	V
V_{CEO}	Collector-emitter Voltage ($I_B = 0$)	200	V
V_{EBO}	Emitter-base Voltage ($I_C = 0$)	5	V
I_C	Collector Current	3	A
I_B	Base Current	1	A
P_{tot}	Total Power Dissipation at $T_{amb} \leq 25^\circ\text{C}$ $T_{case} \leq 25^\circ\text{C}$	1.25	W
		25	W
T_{stg}	Storage Temperature	- 65 to 150	$^\circ\text{C}$
T_j	Junction Temperature	150	$^\circ\text{C}$

THERMAL DATA

$R_{thj-case}$	Thermal Resistance Junction-case	Max	5	°C/W
$R_{thj-amb}$	Thermal Resistance Junction-amb.	Max	100	°C/W

ELECTRICAL CHARACTERISTICS ($T_{case} = 25\text{ °C}$ unless otherwise specified)

Symbol	Parameter	Test Conditions	Min.	Typ.	Max.	Unit
I_{CBO}	Collector Cutoff Current ($I_E = 0$)	$V_{CB} = 200\text{ V}$			100	μA
V_{CBO}	Collector-base Breakdown Voltage ($I_E = 0$)	$I_C = 100\ \mu\text{A}$	200			V
$V_{CE(0.1\text{SUS})}^*$	Collector-emitter Sustaining Voltage ($I_B = 0$)	$I_C = 10\text{ mA}$	200			V
V_{EBO}^*	Emitter-base Voltage ($I_C = 0$)	$I_E = 1\text{ mA}$	5			V
$V_{CE(sat)}^*$	Collector-emitter Saturation Voltage	$I_C = 150\text{ mA}$		0.06	1.0	V
		$I_C = 500\text{ mA}$	$I_B = 15\text{ mA}$ $I_B = 50\text{ mA}$	0.10	1.5	V
$V_{BE(sat)}^*$	Base-emitter Saturation Voltage	$I_C = 150\text{ mA}$	$I_B = 15\text{ mA}$	0.73	1.0	V
		$I_C = 500\text{ mA}$	$I_B = 50\text{ mA}$	0.80	1.2	V
h_{FE}^*	DC Current Gain	$I_C = 50\text{ mA}$	$V_{CE} = 5\text{ V}$	30		200
		$I_C = 150\text{ mA}$	$V_{CE} = 5\text{ V}$	30		200
		$I_C = 500\text{ mA}$	$V_{CE} = 5\text{ V}$	30		200
f_T	Transition Frequency	$I_C = 500\text{ mA}$	$V_{CE} = 5\text{ V}$		40	MHz
C_{CBO}	Collector-base Capacitance	$I_E = 0$ $f = 1\text{ MHz}$	$V_{CB} = 10\text{ V}$		50	pF
t_{on}	Turn-on Time	$I_C = 0.5\text{ A}$ $V_{CC} = 20\text{ V}$	$I_{B1} = 50\text{ mA}$		0.3	μs
t_{off}	Turn-off Time	$I_C = 0.5\text{ A}$ $I_{B1} = -I_{B2} = 50\text{ mA}$ $V_{CC} = 20\text{ V}$			1	μs

* Pulsed : pulse duration = 300 μs , duty cycle = 1.5 %.

Safe Operating Area.

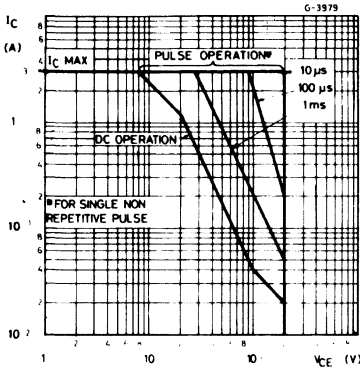

DC Current Gain.

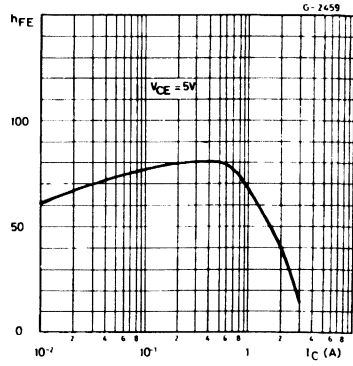

Collector-emitter Saturation Voltage.

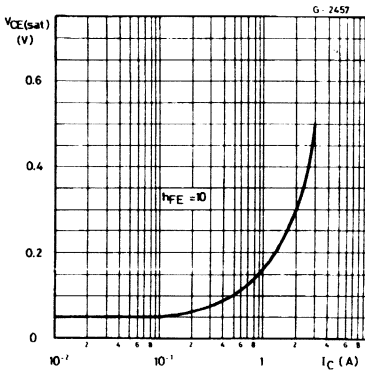

Base-emitter Saturation Voltage.

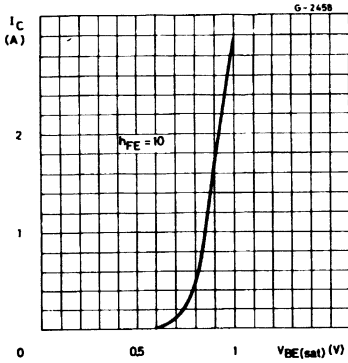

Collector-emitter Saturation Voltage.

Transition Frequency.

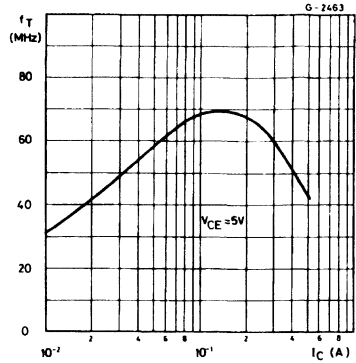

Saturated Switching Characteristics .

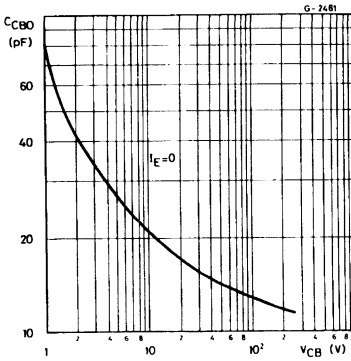

Power Rating Chart.

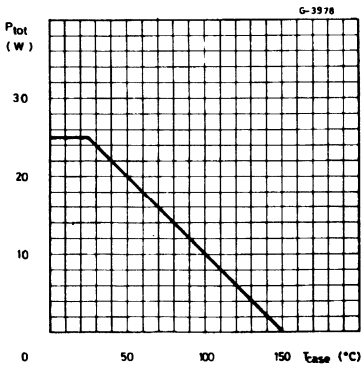
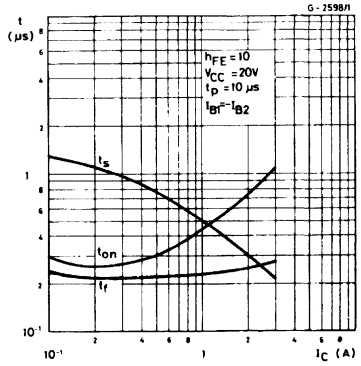

HIGH VOLTAGE POWER SWITCH

DESCRIPTION

The BU326 and BU326A are silicon multiepitaxial mesa NPN transistors in Jedec TO-3 metal case particularly intended for switch-mode CTV supply system.

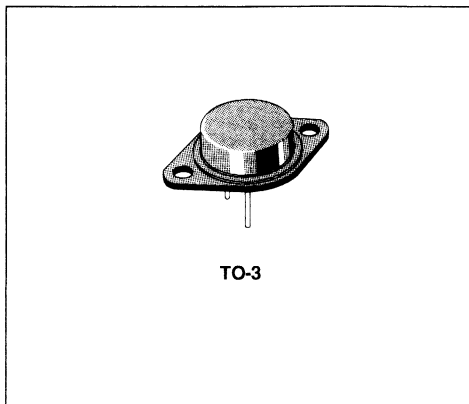

INTERNAL SCHEMATIC DIAGRAM

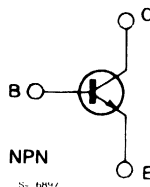

ABSOLUTE MAXIMUM RATINGS

Symbol	Parameter	Value		Unit
		BU326A	BU326	
V_{CES}	Collector-emitter Voltage ($V_{BE} = 0$)	900	800	V
V_{CEO}	Collector-emitter Voltage ($I_B = 0$)	400	325	V
V_{EBO}	Base-emitter Voltage ($I_C = 0$)	10		V
I_C	Collector Current	6		A
I_{CM}	Collector Peak Current	8		A
I_B	Base Current	3		A
P_{tot}	Total Power Dissipation at $T_{case} \leq 25^\circ\text{C}$	75		W
T_{stg}	Storage Temperature	- 65 to 200		$^\circ\text{C}$
T_J	Junction Temperature	200		$^\circ\text{C}$

THERMAL DATA

$R_{thj-case}$	Thermal Resistance Junction-case	Max	2.33	°C/W
----------------	----------------------------------	-----	------	------

ELECTRICAL CHARACTERISTICS($T_{case} = 25\text{ °C}$ unless otherwise specified)

Symbol	Parameter	Test Conditions		Min.	Typ.	Max.	Unit	
I_{CES}	Collector Cutoff Current ($V_{BE} = 0$)	$V_{CE} = 900V$	for BU326A			1	mA	
		$V_{CE} = 900V$	for BU326			1	mA	
		$V_{CE} = 900V$						
		$T_{case} = 125\text{°C}$	for BU326			2	mA	
		$V_{CE} = 900V$	for BU326A			2	mA	
I_{EBO}	Emitter Cutoff Current ($I_C = 0$)	$V_{EB} = 10V$				10	mA	
$V_{CE0(sus)}$ *	Collector-emitter Sustaining Voltage ($I_B = 0$)	$I_C = 100mA$	for BU326 for BU326A	325 400			V V	
$V_{CE(sat)}$ *	Collector-emitter Saturation Voltage	$I_C = 2.5A$	$I_B = 0.5A$			1.5	V	
		$I_C = 4A$	$I_B = 1.25A$			3	V	
$V_{BE(sat)}$ *	Base-emitter Saturation Voltage	$I_C = 2.5A$	$I_B = 0.5A$			1.4	V	
		$I_C = 4A$	$I_B = 1.25A$			1.6	V	
h_{FE} *	DC Current Gain	$I_C = 1A$	$V_{CE} = 5V$		25			
t_{on}	Turn-on Time	$I_C = 2.5A$ $V_{CC} = 250V$	$I_{B1} = 0.5A$			0.5	μs	
t_s	Storage Time	$I_C = 2.5A$	$I_{B1} = 0.5A$					
		$I_{B2} = -1A$	$V_{CC} = 250V$			3.5	μs	
t_f	Fall Time	$I_C = 2.5A$ $I_{B2} = -1A$	$I_{B1} = 0.5A$ $V_{CC} = 250V$			0.5	μs	

* Pulsed : pulse duration = 300 μs , duty cycle = 1.5%.

Safe Operating Areas.

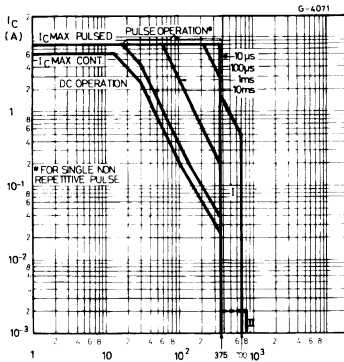

- I – Area of permissible operation during turn-on provided $R_{BE} \leq 100\Omega$ and $t_p \leq 0.6$
- II - Area of permissible operation with $V_{BE} \leq 0$ and $t_p \leq 2\mu s$

Derating Curves.

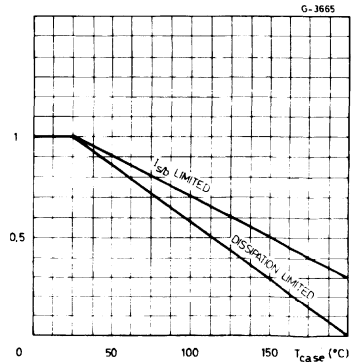

Thermal Transient Response.

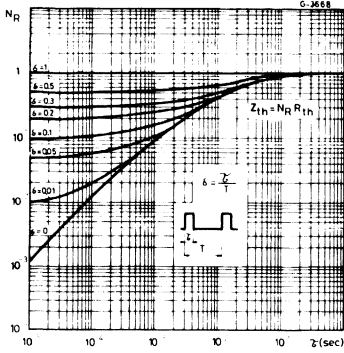

DC Current Gain.

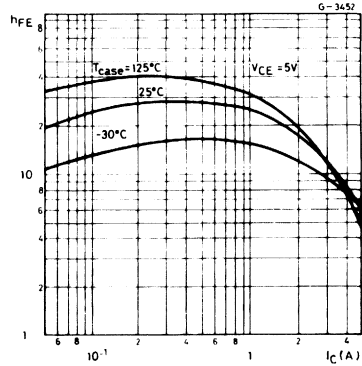

Collector-emitter Saturation Voltage.

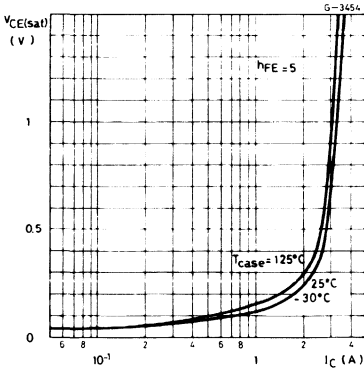

Collector-emitter Saturation Voltage.

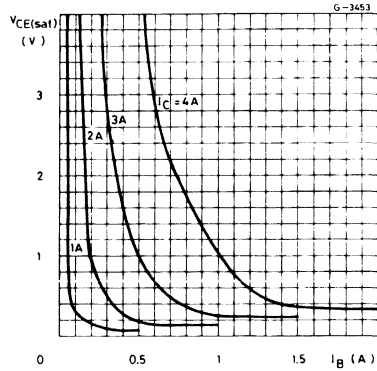

Base-emitter Saturation Voltage.

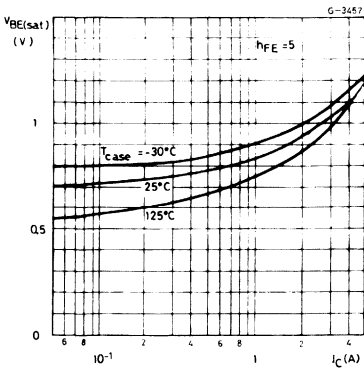

Saturated Switching Characteristics.

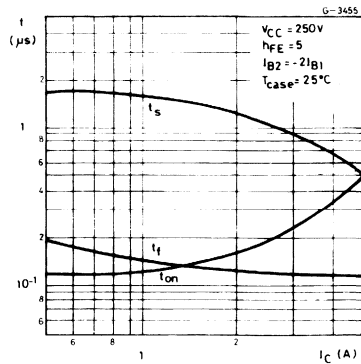

Saturated Switching Characteristics.

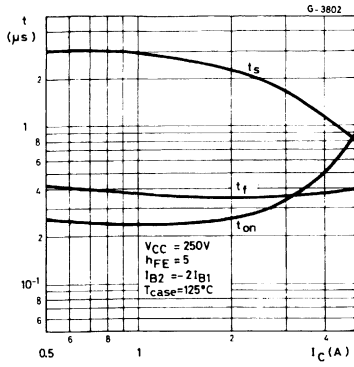

HORIZONTAL TV DEFLECTORS
DESCRIPTION

The BU406, BU406H, and BU408 are silicon epitaxial planar NPN transistors in Jedec TO-220 plastic package. They are fast switching, high voltage devices for use in horizontal deflection output stages of large screen MTV receivers with 110° CRT.

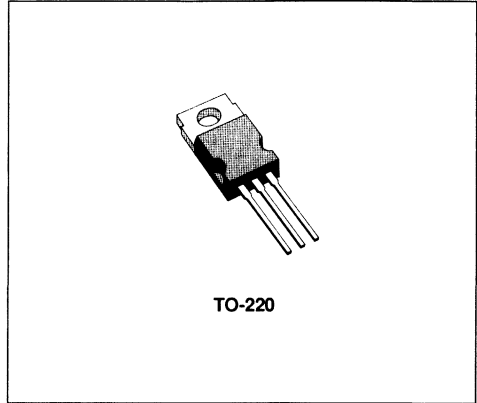
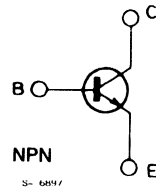
INTERNAL SCHEMATIC DIAGRAM

ABSOLUTE MAXIMUM RATINGS

Symbol	Parameter	Value	Unit
V_{CBO}	Collector-base Voltage ($I_E = 0$)	400	V
V_{CEV}	Collector-emitter Voltage ($V_{BE} = -1.5V$)	400	V
V_{CEO}	Collector-emitter Voltage ($I_B = 0$)	200	V
V_{EBO}	Emitter-base Voltage ($I_C = 0$)	6	V
I_C	Collector Current	7	A
I_{CM}	Collector Peak Current (repetitive)	10	A
I_{CM}	Collector Peak Current ($t_p = 10ms$)	15	A
I_B	Base Current	4	A
P_{tot}	Total Power Dissipation at $T_{case} \leq 25^\circ C$	60	W
T_{stg}	Storage Temperature	- 65 to 150	$^\circ C$
T_j	Junction Temperature	150	$^\circ C$

THERMAL DATA

$R_{th\ j-case}$	Thermal Resistance Junction-case	Max	2.08	°C/W
$R_{th\ j-amb}$	Thermal Resistance Junction-ambient	Max	70	°C/W

ELECTRICAL CHARACTERISTICS($T_{case} = 25^{\circ}C$ unless otherwise specified)

Symbol	Parameter	Test Conditions	Min.	Typ.	Max.	Unit
I_{CES}	Collector Cutoff Current ($V_{BE} = 0$)	$V_{CE} = 400V$ $V_{CE} = 250V$ $V_{CE} = 250V$ $T_{case} = 150^{\circ}C$			5 100 1	mA μA mA
I_{EBO}	Emitter Cutoff Current ($I_C = 0$)	$V_{EB} = 6V$			1	mA
$V_{CE(sat)^*}$	Collector-emitter Saturation Voltage	for BU406 $I_C = 5A$ for BU406H $I_C = 5A$ for BU408 $I_C = 6A$ $I_B = 0.5A$ $I_B = 0.8A$ $I_B = 1.2A$			1 1 1	V V V
$V_{BE(sat)^*}$	Base-emitter Saturation Voltage	for BU406 $I_C = 5A$ for BU406H $I_C = 5A$ for BU408 $I_C = 6A$ $I_B = 0.5A$ $I_B = 0.8A$ $I_B = 1.2A$			1.2 1.2 1.5	V V V
f_T	Transition Frequency	$I_C = 0.5A$ $V_{CE} = 10V$	10			MHz
t_{off}^{**}	Turn-off Time	for BU406 $I_C = 5A$ for BU406H $I_C = 5A$ for BU408 $I_C = 6A$ $I_{Bend} = 0.5A$ $I_{Bend} = 0.8A$ $I_{Bend} = 1.2A$			0.75 0.4 0.4	μs μs μs
$I_{S/b}$	Second Breakdown Collector Current	$V_{CE} = 40V$ $t = 10ms$			4	A

* Pulsed : pulse duration = 300 μs , duty cycle = 1.5%.

** See test circuit.

DC Current Gain.

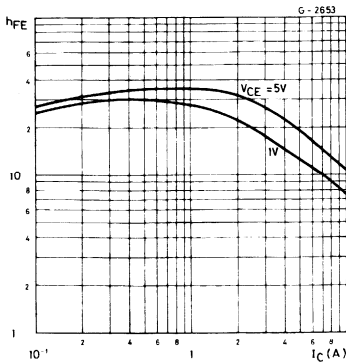

Collector-emitter Saturation Voltage.

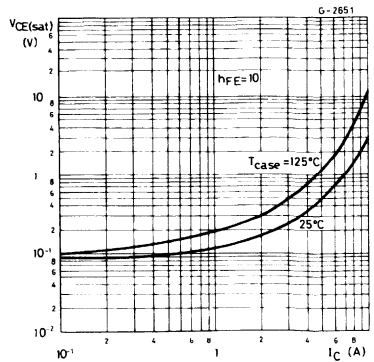

Base-emitter Saturation Voltage.

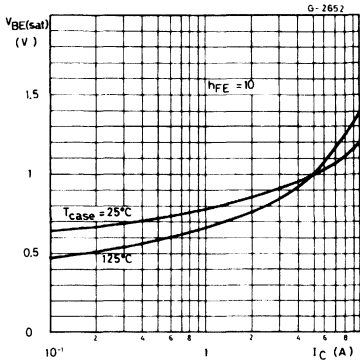

Collector cutoff Current.

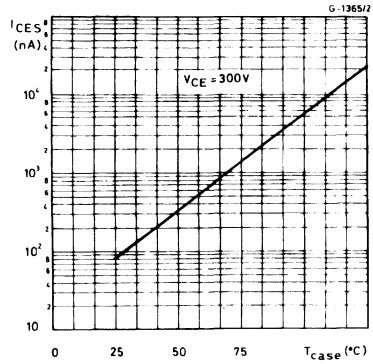

Storage Time.

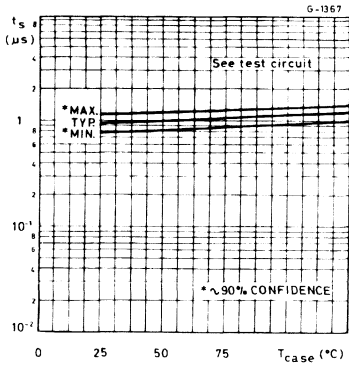

Fall Time.

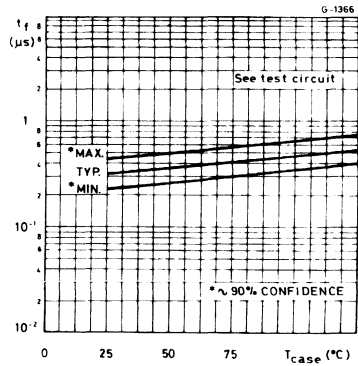

Turn-off Time.

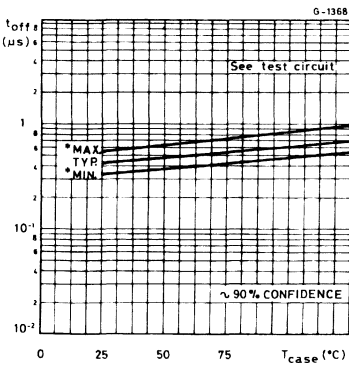

Collector-emitter Saturation Voltage.

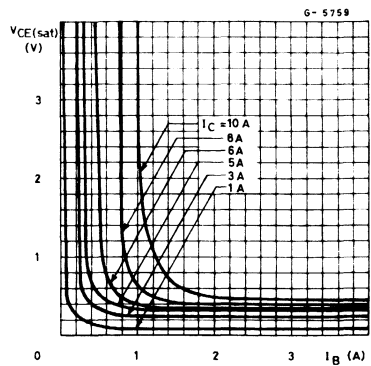

SWITCHING TIMES

TEST CIRCUIT (FALL, STORAGE AND TURN-OFF TIME)

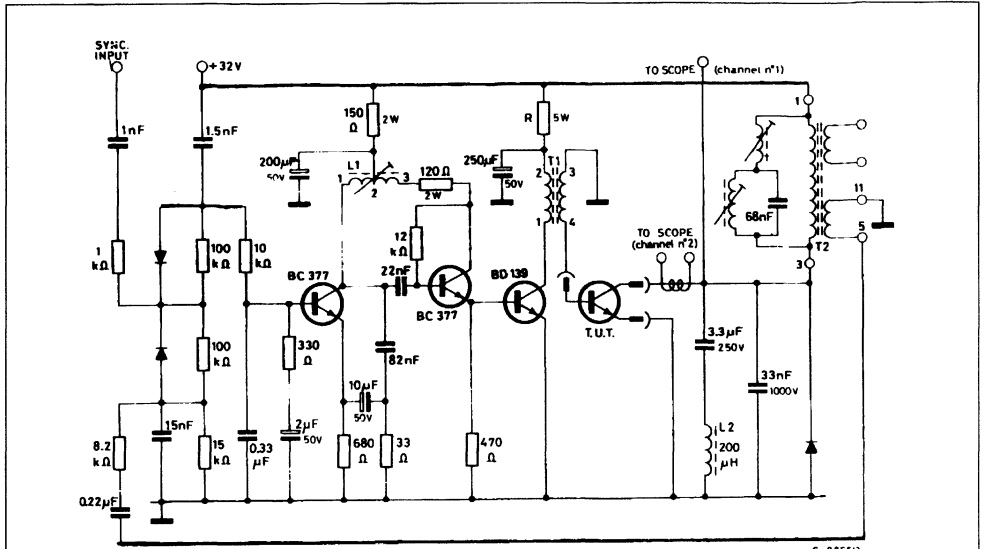

L1 Horizontal hold coil : Pins 1-2 = 75 turns \varnothing 0.2mm ; R = 1.5 Ω ; L min = 0.62mH
 Pins 2-3 = 293 turns \varnothing 0.2mm ; R = 4.8 Ω ; L max = 4.1H
 L2 Horizontal yoke = 200 μ H
 T1 Driver transformer : Pins 1-2 = 125 turns \varnothing 0.2mm ; Gap = 0.12mm ; Core = 3E3 double E 19x15x5
 Pins 3-4 = 25 turns \varnothing 0.4mm ;
 T2 EHT transformer manufacturer ARCO type 249.065/035
 R = 330 Ω for BU406
 R = 220 Ω for BU406H
 R = 180 Ω for BU408

WAVEFORMS

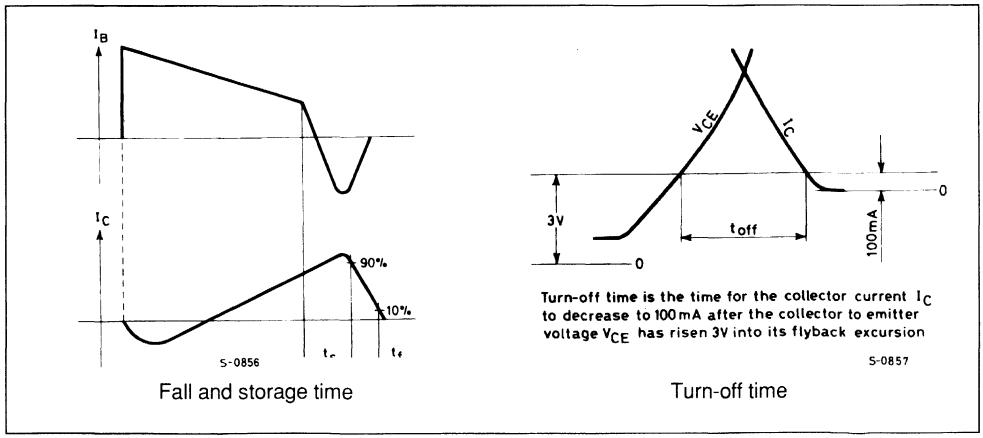

APPLICATION INFORMATION

BU406 - APPLICATION CIRCUIT FOR 17" TO 24" - 110° - 28 MM NECK PICTURE TUBES

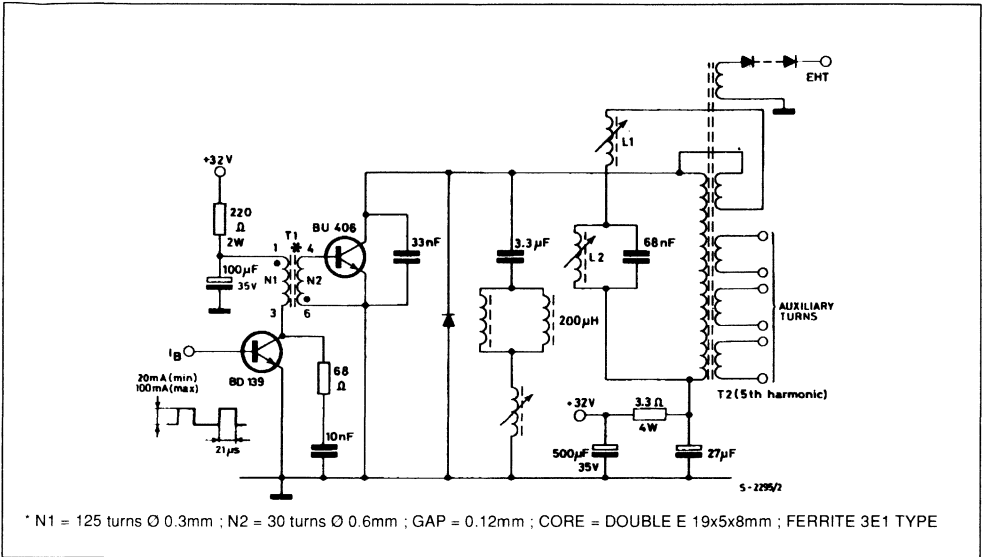

HORIZONTAL TV DEFLECTORS

DESCRIPTION

The BU406D, BU407D, and BU408D are silicon planar epitaxial NPN transistors with integrated damper diode, in Jedec TO-220 plastic package. They are fast switching, high voltage devices for use in horizontal deflection output stages of MTV receivers with 110° CRT.

The BU406D and BU408D are primarily intended for large screen, while the BU407D is for medium and small screens.

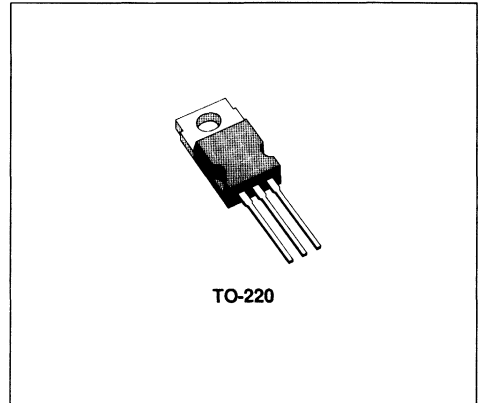

INTERNAL SCHEMATIC DIAGRAM

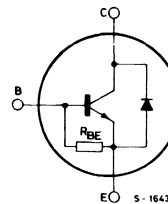

ABSOLUTE MAXIMUM RATINGS

Symbol	Parameter	Value			Unit
		BU406D	BU407D	BU408D	
V_{CBO}	Collector-base Voltage ($I_E = 0$)	400	330	400	V
V_{CEV}	Collector-emitter Voltage ($V_{BE} = -1.5V$)	400	330	400	V
V_{EBO}	Emitter-base Voltage ($I_C = 0$)	6			V
I_C	Collector Current	7			A
I_{CM}	Collector Peak Current (repetitive)	10			A
I_{CM}	Collector Peak Current ($t_p = 10ms$)	15			A
I_B	Base Current	4			A
P_{tot}	Total Power Dissipation at $T_{case} \leq 25^\circ C$	60			W
T_{stg}	Storage Temperature	- 65 to 150			$^\circ C$
T_j	Junction Temperature	150			$^\circ C$

THERMAL DATA

$R_{th\ j-case}$	Thermal Resistance Junction-case	Max	2.08	°C/W
$R_{th\ j-amb}$	Thermal Resistance Junction-ambient	Max	70	°C/W

ELECTRICAL CHARACTERISTICS ($T_{case} = 25^{\circ}C$ unless otherwise specified)

Symbol	Parameter	Test Conditions	Min.	Typ.	Max.	Unit
I_{CEV}	Collector Cutoff Current ($V_{BE} = -1.5V$)	for BU406D and BU408D $V_{CE} = 400V$ for BU407D $V_{CE} = 330V$			15	mA
I_{EBO}	Emitter Cutoff Current ($I_C = 0$)	$V_{EB} = 6V$			400	mA
$V_{CE(sat)}^*$	Collector-emitter Saturation Voltage	for BU406D and BU407D $I_C = 5A$ $I_B = 0.65A$ for BU408D $I_C = 6A$ $I_B = 1.2A$			1	V
$V_{BE(sat)}^*$	Base-emitter Saturation Voltage	for BU406D and BU407D $I_C = 5A$ $I_B = 0.65A$ for BU408D $I_C = 6A$ $I_B = 1.2A$			1.3 1.5	V
f_T	Transition Frequency	$I_C = 0.5A$ $V_{CE} = 10V$	10			MHz
t_{off}	Turn-off Time	for BU406D and BU407D $I_C = 5A$ $I_{Bend} = 0.65A$ for BU408D $I_C = 6A$ $I_{Bend} = 1.2A$			0.75 0.5	μs
$I_{s/b}$	Second Breakdown Collector Current	$V_{CE} = 40V$ $t = 10ms$		4		A
V_F	Diode Forward Voltage	$I_F = 5A$			1.5	V

* Pulsed : pulse duration = 300 μs , duty cycle = 1.5%.

DC Current Gain.

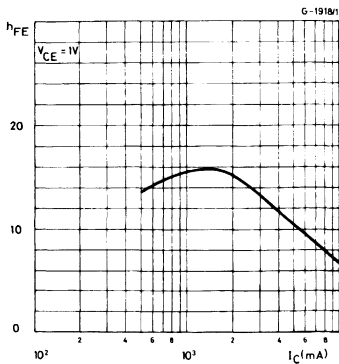

Collector-emitter Saturation Voltage.

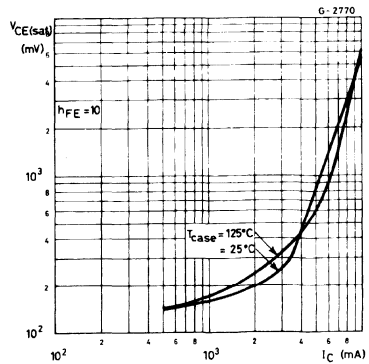

Base-emitter Saturation Voltage.

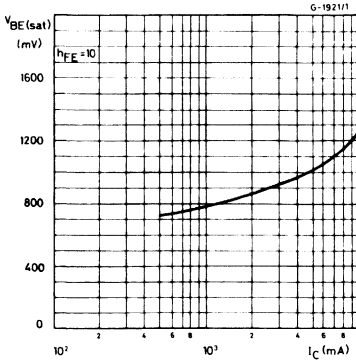

Forward Voltage.

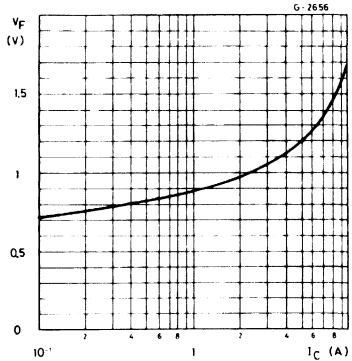

SWITCHING TIMES

TEST CIRCUIT (FALL, STORAGE AND TURN-OFF TIME)

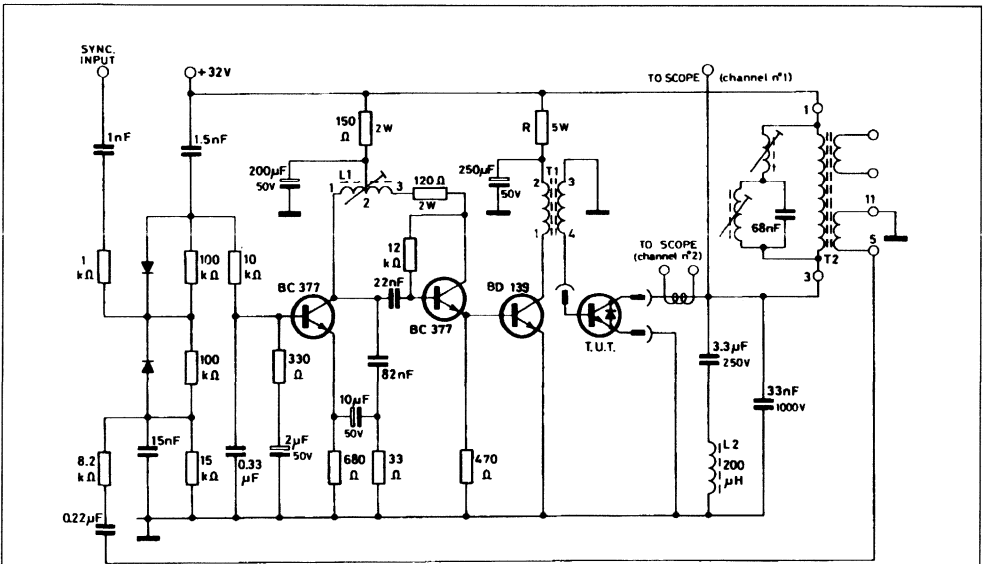

S-2297/1

- L1 Horizontal hold coil : Pins 1-2 = 75 turns Ø 0.2mm ; R = 1.5Ω ; L min = 0.62mH
- Core = siferrit B 62120 25x4x2
- Pins 2-3 = 293 turns Ø 0.2mm ; R = 4.8Ω ; L max = 4.1mH
- L2 Horizontal yoke = 200μH
- T1 Driver transformer : Pins 1-2 = 125 turns Ø 0.2mm ;
- Gap = 0.12mm ; Core = 3E3 double E 19x15x5
- Pins 3-4 = 25 turns Ø 0.4mm ;
- T2 EHT transformer manufacturer ARCO type 249.065/035
- R = 270Ω for BU406D and BU407D
- R = 180Ω for BU408D

Waveforms

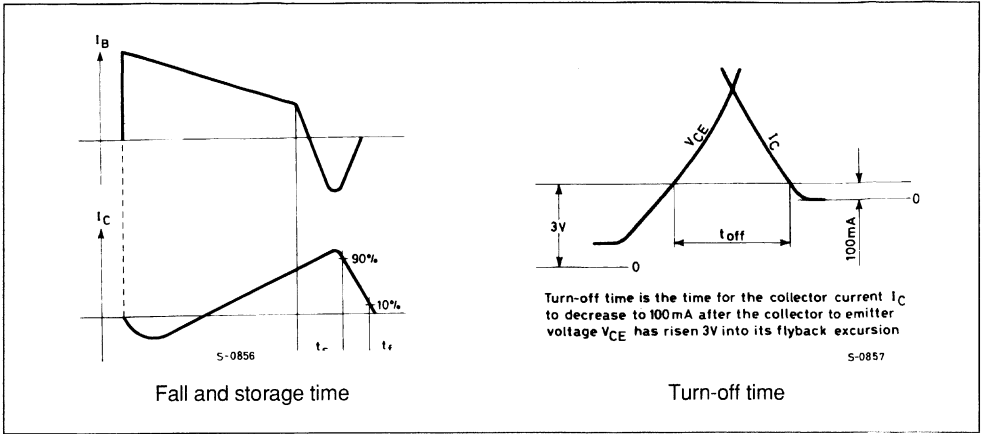

APPLICATION INFORMATION

Two examples are given of the BU406D and BU407D in conventional MTV horizontal deflection circuits.

BU406D - application circuit for 17" to 24" - 110° - 28 mm neck picture tubes.

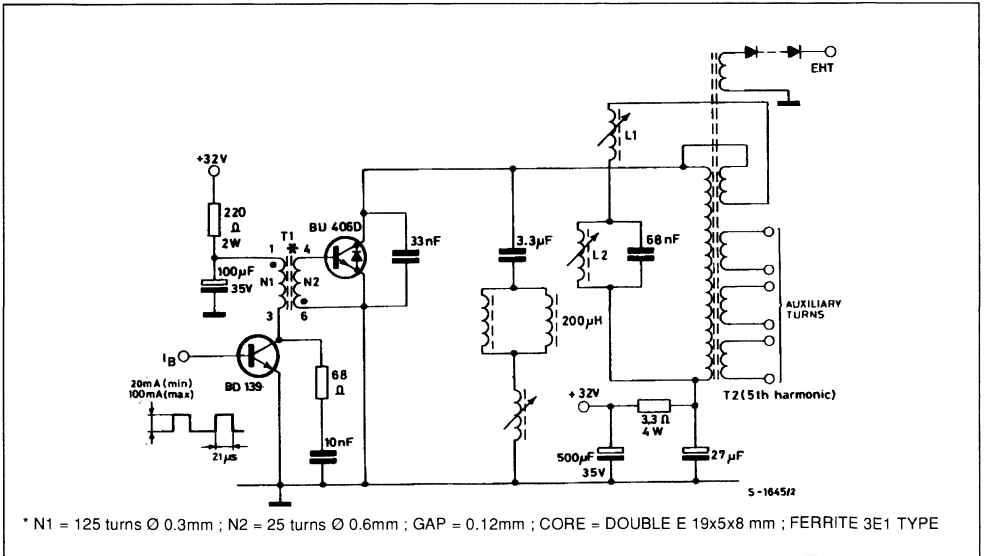

APPLICATION INFORMATION (continued)

BU407D - application circuit for 12" to 17" - 110° - 28mm neck picture tubes
(drive supply voltage = 10.8V).

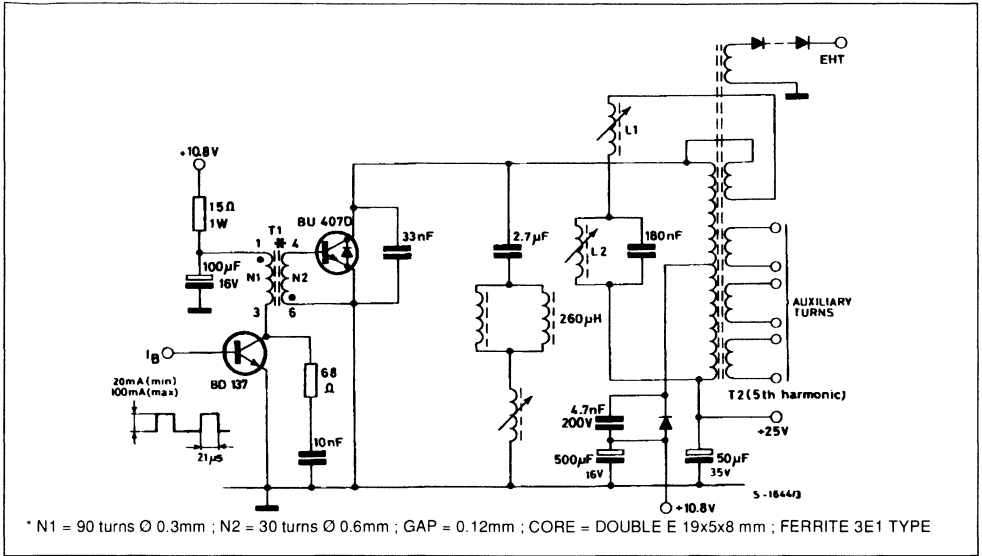

BU407D - application circuit for 12" to 17" - 110° - 28mm neck picture tubes.
(driver supply voltage = 10.8V).

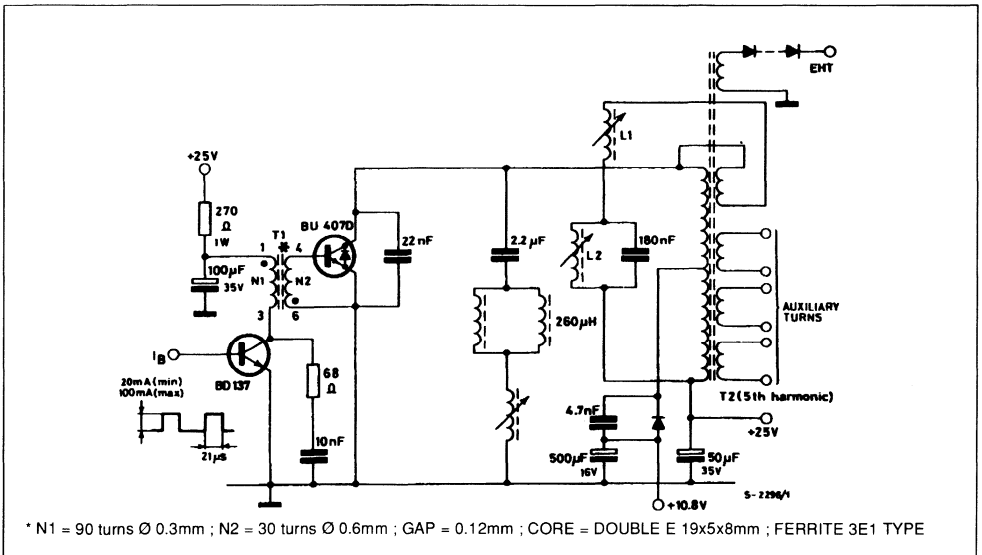

HORIZONTAL TV DEFLECTORS

DESCRIPTION

The BU407 and BU407H are silicon epitaxial planar NPN transistors in Jedec TO-220 plastic package.

They are fast switching, high voltage devices for use in horizontal deflection output stages of medium and small screens MTV receivers with 110° CRT as monochrome computer terminals.

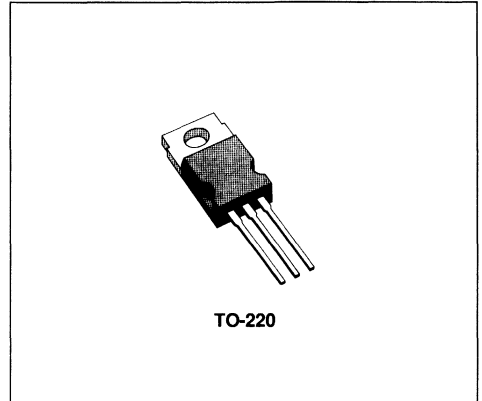

INTERNAL SCHEMATIC DIAGRAM

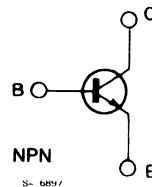

ABSOLUTE MAXIMUM RATINGS

Symbol	Parameter	Value	Unit
V_{CBO}	Collector-base Voltage ($I_E = 0$)	330	V
V_{CEV}	Collector-emitter Voltage ($V_{BE} = -1.5$ V)	330	V
V_{CEO}	Collector-emitter Voltage ($I_B = 0$)	150	V
V_{EBO}	Emitter-base Voltage ($I_C = 0$)	6	V
I_C	Collector Current	7	A
I_{CM}	Collector Peak Current (repetitive)	10	A
I_{CM}	Collector Peak Current ($t = 10$ ms)	15	A
I_B	Base Current	4	A
P_{tot}	Total Power Dissipation at $T_{case} \leq 25$ °C	60	W
T_{stg}	Storage Temperature	- 65 to 150	°C
T_j	Junction Temperature	150	°C

THERMAL DATA

$R_{thj-case}$	Thermal Resistance Junction-case	Max	2.08	°C/W
$R_{thj-amb}$	Thermal Resistance Junction-ambient	Max	70	°C/W

ELECTRICAL CHARACTERISTICS ($T_{case} = 25\text{ °C}$ unless otherwise specified)

Symbol	Parameter	Test Conditions	Min.	Typ.	Max.	Unit
I_{CES}	Collector Cutoff Current ($V_{BE} = 0$)	$V_{CE} = 330\text{ V}$ $V_{CE} = 200\text{ V}$ $V_{CE} = 200\text{ V}$ $T_{case} = 150\text{ °C}$			5 100 1	mA μA mA
I_{EBO}	Emitter Cutoff Current ($I_C = 0$)	$V_{EB} = 6\text{ V}$			1	mA
$V_{CE(sat)}^*$	Collector-emitter Saturation Voltage	for BU407 $I_C = 5\text{ A}$ $I_B = 0.5\text{ A}$ for BU407H $I_C = 5\text{ A}$ $I_B = 0.8\text{ A}$			1 1	V V
$V_{BE(sat)}^*$	Base-emitter Saturation Voltage	for BU407 $I_C = 5\text{ A}$ $I_B = 0.5\text{ A}$ for BU407H $I_C = 5\text{ A}$ $I_B = 0.8\text{ A}$			1.2 1.2	V V
f_T	Transition Frequency	$I_C = 0.5\text{ A}$ $V_{CE} = 10\text{ V}$	10			MHz
t_{off}^{**}	Turn-off Time	for BU407 $I_C = 5\text{ A}$ $I_{Bend} = 0.5\text{ A}$ for BU407H $I_C = 5\text{ A}$ $I_{Bend} = 0.8\text{ A}$			0.75 0.4	μs μs
$I_{s/b}$	Second Breakdown Collector Current	$V_{CE} = 40\text{ V}$ $t = 10\text{ ms}$		4		A

* Pulsed : pulse duration = 300 μs, duty cycle = 1.5 %.
 ** See Test Circuit.

DC Current Gain.

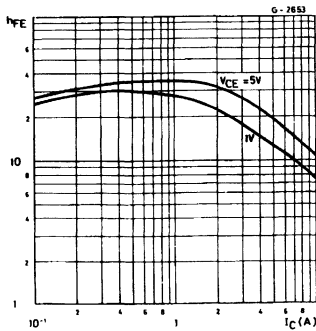

Collector-emitter Saturation Voltage.

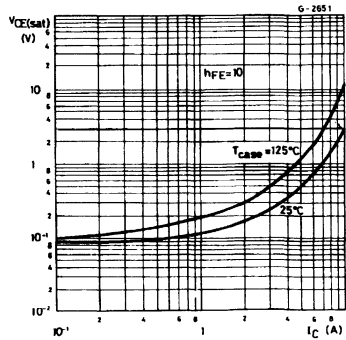

Base-emitter Saturation Voltage.

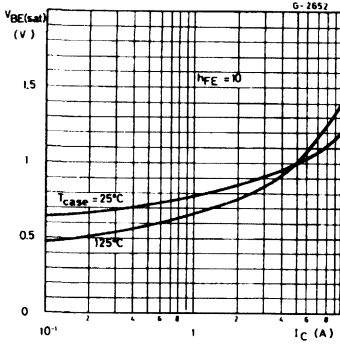

Collector Cutoff Current.

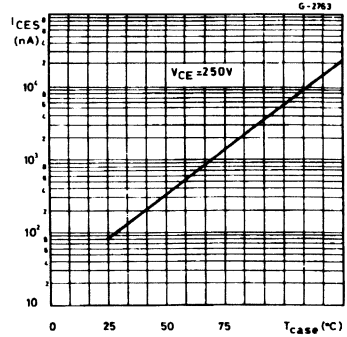

Storage Time.

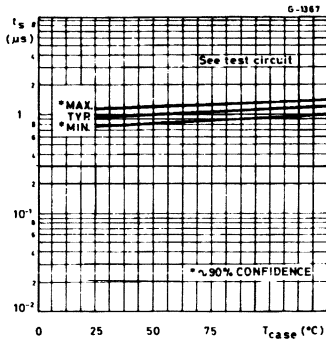

Fall Time.

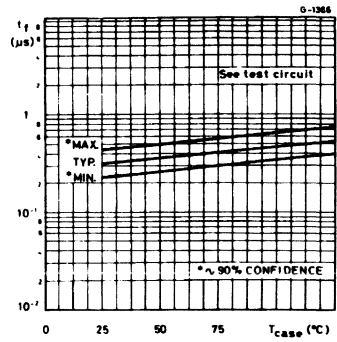

Turn-off Time.

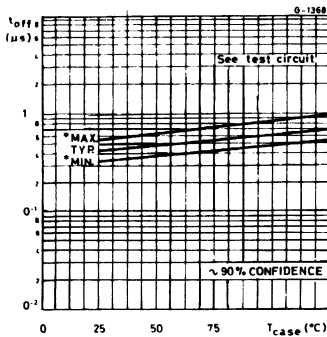

Collector-emitter Saturation Voltage.

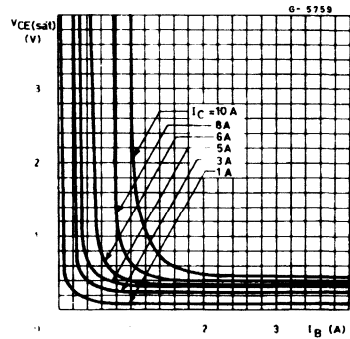

SWITCHING TIMES

TEST CIRCUIT (fall, storage and turn-off time)

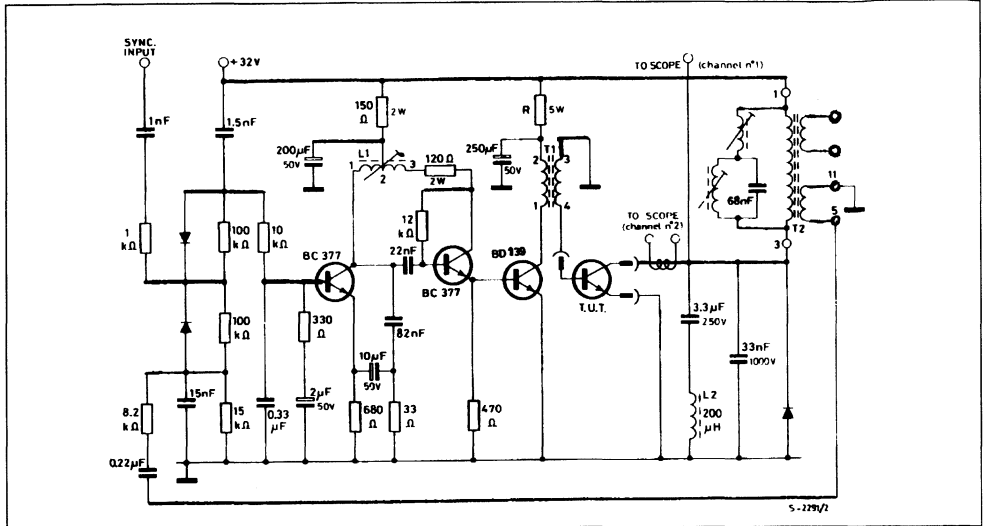

- L1 Horizontal hold coil : Pins 1-2 = 75 turns ϕ 0.2 mm ; R = 1.5 Ω ; L min = 0.62mH
 Pins 2-3 = 293 turns ϕ 0.2 mm ; R = 4.8 Ω ; L max = 4.1 mH Core = siferitt B 62120 25x4x2
- L2 Horizontal yoke = 200 μ H
- T1 Driver transformer : Pins 1-2 = 125 turns ϕ 0.2 mm ;
 Pins 3-4 = 25 turns ϕ 0.4 mm ; Gap = 0.12 mm ; Core = 3 E 3 double E 19x15x5
- T2 EHT transformer manufacturer ARCO type 249.065/035
- R = 330 Ω for BU407
 R = 220 Ω for BU 407H.

WAVEFORMS

Fall and Storage Time.

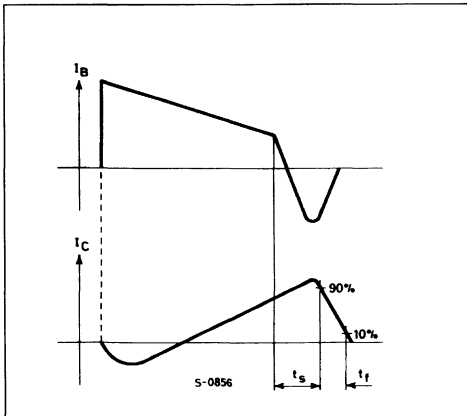

Turn-off Time.

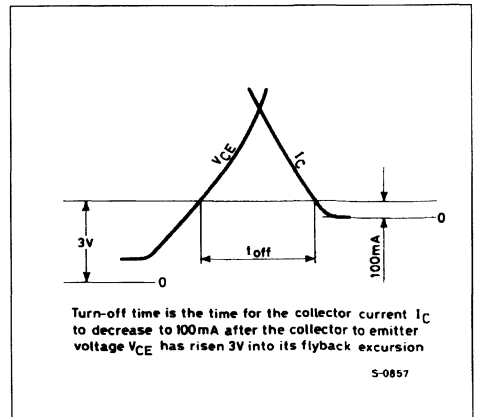

APPLICATION INFORMATION

Two examples are given of the BU407 in conventional MTV horizontal deflection circuits

BU407 : Application Circuit for 12" to 17" – 110° – 20 mm neck picture tubes
(driver supply voltage = 10.8 V).

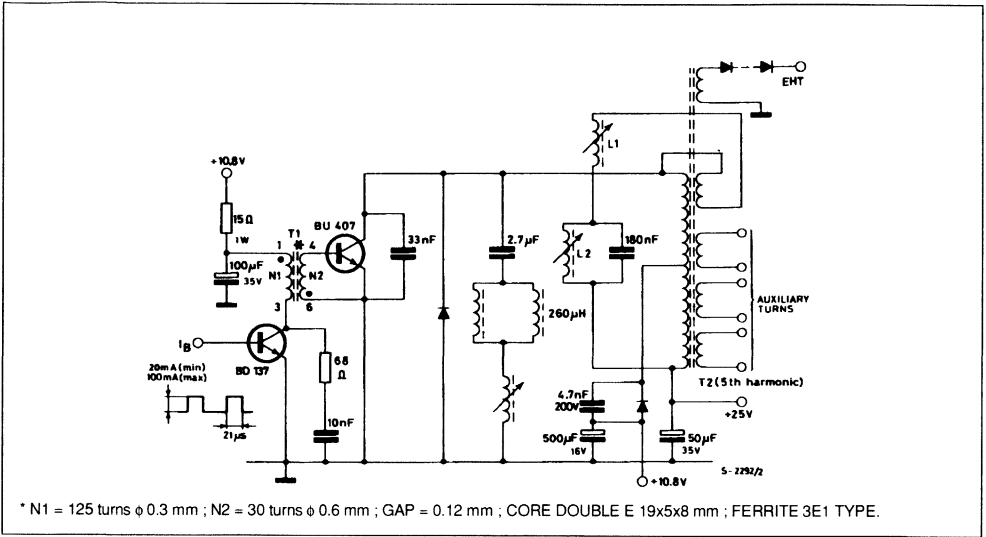

BU407 : Application Circuit for 12" to 17" – 110° – 20 mm neck picture tubes
(driver supply voltage = 25 V).

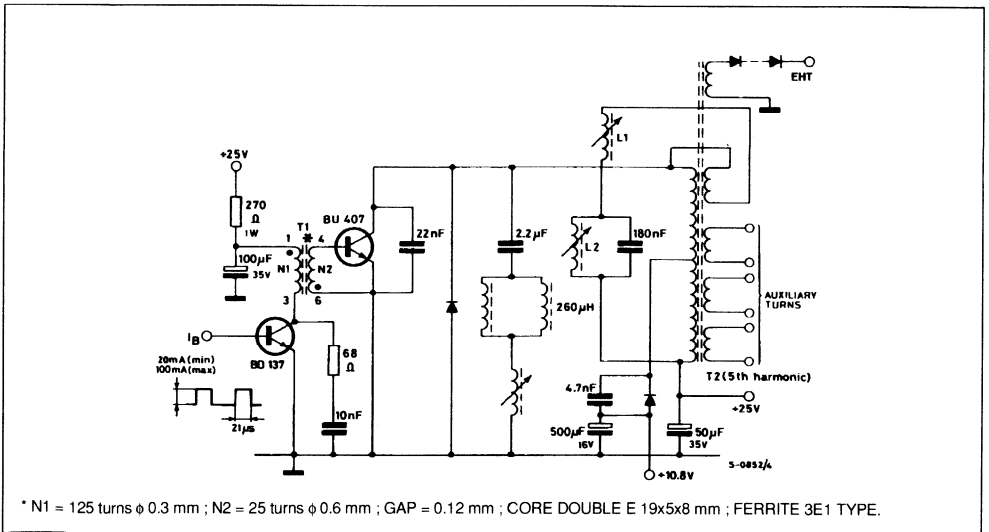

HIGH VOLTAGE POWER SWITCH

DESCRIPTION

The BU426 and BU426A are silicon multiepitaxial mesa NPN transistors in SOT-93 plastic package, particularly intended for switch-mode CTV supply systems.

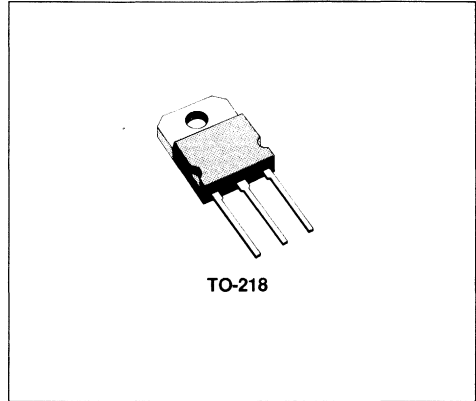

INTERNAL SCHEMATIC DIAGRAMS

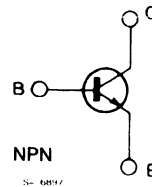

ABSOLUTE MAXIMUM RATINGS

Symbol	Parameter	Value		Unit
		BU426	BU426A	
V_{CES}	Collector-emitter Voltage ($V_{BE} = 0$)	800	900	V
V_{CEO}	Collector-emitter Voltage ($I_B = 0$)	375	400	V
V_{EBO}	Emitter-base Voltage ($I_C = 0$)	10		V
I_C	Collector-current	6		A
I_{CM}	Collector-peak Current ($t_p = 2$ ms)	8		A
I_B	Base Current	3		A
P_{tot}	Total Power Dissipation at $T_{case} \leq 25$ °C	113		W
T_{stg}	Storage Temperature	- 65 to 150		°C
T_J	Junction Temperature	150		°C

THERMAL DATA

$R_{thj-case}$	Thermal Resistance Junction-case	Max	1.1	°C/W
----------------	----------------------------------	-----	-----	------

ELECTRICAL CHARACTERISTICS ($T_{case} = 25\text{ °C}$ unless otherwise specified)

Symbol	Parameter	Test Conditions		Min.	Typ.	Max.	Unit
I_{CES}	Collector Cutoff Current ($V_{BE} = 0$)	for BU426	$V_{CE} = 800\text{ V}$			1	mA
		for BU426A	$V_{CE} = 900\text{ V}$			1	mA
		$T_{case} = 125\text{ °C}$					
		for BU426	$V_{CE} = 800\text{ V}$			2	mA
		for BU426A	$V_{CE} = 900\text{ V}$			2	mA
I_{EBO}	Emitter Cutoff Current ($I_C = 0$)	$V_{EB} = 10\text{ V}$				10	mA
$V_{CE0(sus)}^*$	Collector-emitter Sustaining Voltage ($I_B = 0$)	for BU426	$I_C = 100\text{ mA}$	375			V
		for BU426A	$I_C = 100\text{ mA}$	400			V
$V_{CE(sat)}^*$	Collector-emitter Saturation Voltage	$I_C = 2.5\text{ A}$	$I_B = 0.5\text{ A}$			1.5	V
		$I_C = 4\text{ A}$	$I_B = 1.25\text{ A}$			3	V
$V_{BE(sat)}^*$	Base-emitter Saturation Voltage	$I_C = 2.5\text{ A}$	$I_B = 0.5\text{ A}$			1.4	V
		$I_C = 4\text{ A}$	$I_B = 1.25\text{ A}$			1.6	V
h_{FE}^*	DC Current Gain	$I_C = 0.6\text{ A}$	$V_{CE} = 5\text{ V}$		30	60	
t_{on}	Turn-on Time	$I_C = 2.5\text{ A}$ $I_{B1} = 0.5\text{ A}$	$V_{CC} = 250\text{ V}$		0.25	0.5	μs
t_s	Storage Time	$I_C = 2.5\text{ A}$ $I_{B2} = -1\text{ A}$	$V_{CC} = 250\text{ V}$		2.5	3.5	μs
t_f	Fall Time				0.2	0.5	μs
t_f	Fall Time	$I_C = 2.5\text{ A}$ $I_{B2} = -1\text{ A}$	$I_{B1} = 0.5\text{ A}$ $V_{CC} = 250\text{ V}$			0.75	μs
		$T_{case} = 100\text{ °C}$					

* Pulsed : pulse duration = 300 μs, duty cycle = 1.5 %.

Safe Operating Areas.

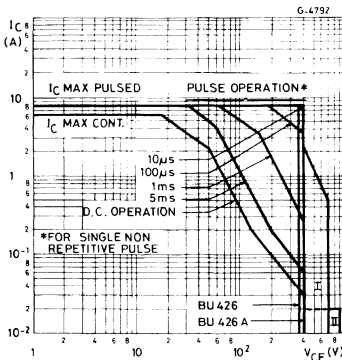

I = Area of permissible operation driving turn-on provided $R_{BE} = 100\Omega$ and $t_p \leq 0.6\mu s$.

II = Area of permissible operation with $V_{BE} \leq 0$; $t_p \leq 2\mu s$.

HIGH VOLTAGE NPN TRANSISTOR

ADVANCE DATA

- HIGH VOLTAGE
- HIGH SPEED SWITCHING

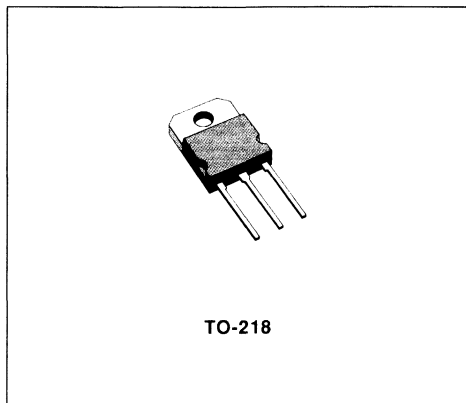

DESCRIPTION

The BU706 is a high voltage, high speed switching silicon multiepitaxial NPN transistor in TO-218 plastic package intended for use in horizontal deflection circuits of colour television receivers and in off-line SMPS.

INTERNAL SCHEMATIC DIAGRAM

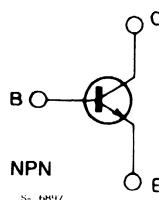

ABSOLUTE MAXIMUM RATINGS

Symbol	Parameter	Value	Unit
V_{CES}	Collector-emitter Voltage ($V_{BE} = 0$)	1500	V
V_{CEO}	Collector-emitter Voltage ($I_B = 0$)	700	V
I_C	Collector Current	5	A
I_{CM}	Collector Peak Current ($t_p < 20\mu s$)	8	A
I_B	Base Current	3	A
I_{BM}	Base Peak Current ($t_p < 20\mu s$)	5	A
P_{tot}	Total Dissipation at $T_c < 25^\circ C$	100	W
T_{stg}	Storage Temperature	- 65 to 150	$^\circ C$
T_j	Max. Operating Junction Temperature	150	$^\circ C$

THERMAL DATA

$R_{thj-case}$	Thermal Resistance Junction-case	max	1.25	°C/W
----------------	----------------------------------	-----	------	------

ELECTRICAL CHARACTERISTICS ($T_{case} = 25^{\circ}C$ unless otherwise specified)

Symbol	Parameter	Test Conditions	Min.	Typ.	Max.	Unit
I_{CES}	Collector Cutoff Current ($V_{BE} = 0$)	$V_{CE} = 1500V$ $V_{CE} = 1500V$ $T_c = 125^{\circ}C$			500 1	μA mA
I_{EBO}	Emitter Cutoff Current ($I_C = 0$)	$V_{EB} = 6V$			10	mA
$V_{CEO(sus)}^*$	Collector-emitter Sustaining Voltage	$I_C = 0.1A$ $L = 25mH$	700			V
$V_{CE(sat)}^*$	Collector-emitter Saturation Voltage	$I_C = 3A$ $I_B = 1.33A$			5	V
$V_{BE(sat)}^*$	Base-emitter Saturation Voltage	$I_C = 3A$ $I_B = 1.33A$			1.3	V
t_f	INDUCTIVE LOAD Fall Time	IN LINE DEFLECTION CIRCUIT $I_C = 3A$ $I_B = 1A$ $L_B = 12\mu H$		0.7		μs

* Pulsed : pulse duration = 300 μs , duty cycle = 1.5%.

HIGH VOLTAGE FAST DARLINGTON

DESCRIPTION

The BU801 is a silicon epitaxial planar NPN Darlington transistor with integrated base-emitter speed-up diode, mounted in Jedec TO-126 plastic package. It is particularly suitable as output stage in medium power and driver stage in high power, fast switching applications.

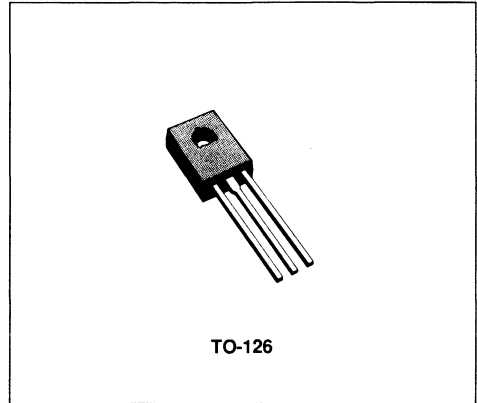

INTERNAL SCHEMATIC DIAGRAM

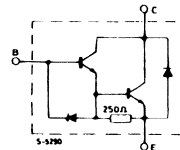

ABSOLUTE MAXIMUM RATINGS

Symbol	Parameter	Value	Unit
V_{CBO}	Collector-base Voltage ($I_E = 0$)	600	V
V_{CEO}	Collector-emitter Voltage ($I_B = 0$)	400	V
V_{EBO}	Emitter-base Voltage ($I_C = 0$)	7	V
I_C, I_E	Collector and Emitter Currents	3	A
I_B	Base Current	1	A
P_{tot}	Total Power Dissipation at $T_{case} \leq 25^\circ\text{C}$	40	W
T_{stg}	Storage Temperature	- 65 to 150	$^\circ\text{C}$
T_j	Junction Temperature	150	$^\circ\text{C}$

THERMAL DATA

R _{thj-case}	Thermal Resistance Junction-case	Max	3.12	°C/W
-----------------------	----------------------------------	-----	------	------

ELECTRICAL CHARACTERISTICS (T_{case} = 25 °C unless otherwise specified)

Symbol	Parameter	Test Conditions	Min.	Typ.	Max.	Unit
I _{CES}	Collector-cutoff Current (V _{BE} = 0)	V _{CE} = 600 V			200	μA
I _{CEO}	Collector-cutoff Current (I _B = 0)	V _{CE} = 400 V			1	mA
I _{EBO} *	Emitter Cutoff Current (I _C = 0)	V _{EB} = 7 V			100	mA
V _{CE0(sus)} *	Collector-emitter Sustaining Voltage	I _C = 10 mA	400			V
V _{CE(sat)} *	Collector-emitter Saturation Voltage	I _C = 200 A I _B = 2 mA I _C = 1 A I _B = 20 mA I _C = 2 A I _B = 200 mA		1.0 1.2 1.8	1.5 2.0 3.0	V V V
V _{BE(sat)} *	Base-emitter Saturation Voltage	I _C = 200 A I _B = 2 mA I _C = 1 A I _B = 20 mA I _C = 2 A I _B = 200 mA			2 2.5 3	V V V
h _{FE} *	DC Current Gain	I _C = 200 mA V _{CE} = 3 V	100			
V _F *	Diode Forward Voltage	I _F = 1 A			4	V

RESISTIVE SWITCHING TIMES

Symbol	Parameter	Test Conditions	Min.	Typ.	Max.	Unit.
t _{on}	Turn-on Time	V _{CC} = 250 V		0.17	0.8	μs
t _s	Storage Time	I _C = 200 mA I _{B1} = 2 mA		0.37	1	μs
t _f	Fall Time	V _{BEoff} = - 5 V		0.13	0.5	μs
t _{on}	Turn-on Time	V _{CC} = 250 V		0.18	0.8	μs
t _s	Storage Time	I _C = 1 A I _{B1} = 20 mA		0.38	1	μs
t _f	Fall Time	V _{BEoff} = - 5 V		0.09	0.5	μs

INDUCTIVE SWITCHING TIMES

Symbol	Parameter	Test Conditions	Min.	Typ.	Max.	Unit.
t _s	Storage Time	V _{Clamp} = 250 V I _C = 200 mA I _{B1} = 2 mA		0.35	1	μs
t _f	Fall Time	V _{BEoff} = - 5 V		0.09	0.4	μs
t _s	Storage Time	V _{Clamp} = 250 V I _C = 1 A I _{B1} = 20 mA		0.5	1	μs
t _f	Fall Time	V _{BEoff} = - 5 V		0.06	0.4	μs

* Pulsed : pulse duration = 300 μs, duty cycle = 1.5 %.

Safe Operating Area.

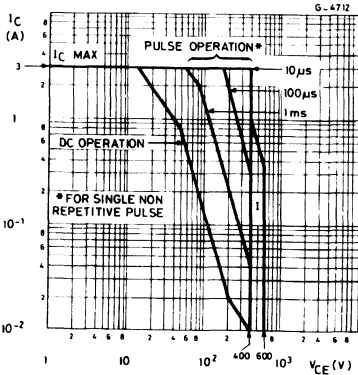

I = Area of permissible operation during turn-on with $t_p \leq 1$ ms.

DC Current Gain.

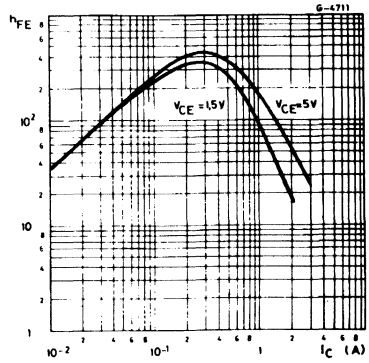

Collector-emitter Saturation Voltage.

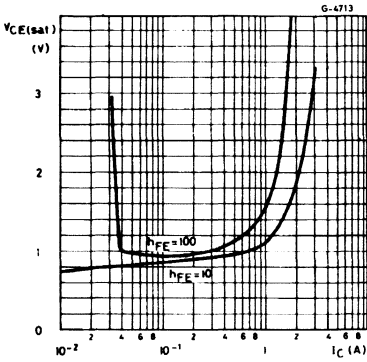

Base-emitter Saturation Voltage.

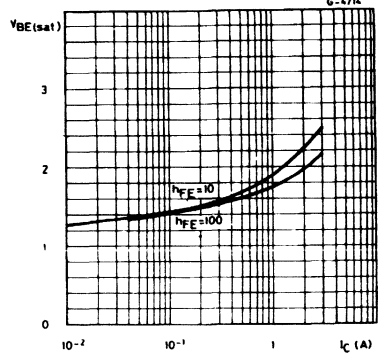

Collector-emitter Saturation Voltage.

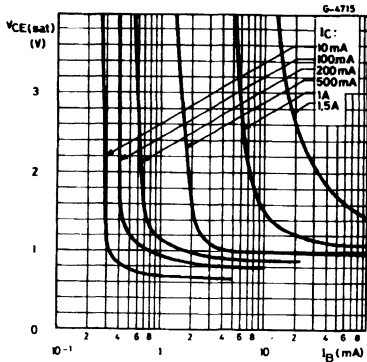

Clamped Reverse Bias Safe Operating Area.

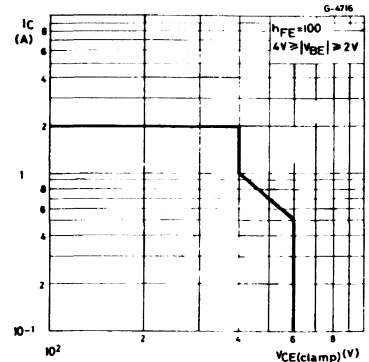

Saturated Switching Characteristics (resistive load).

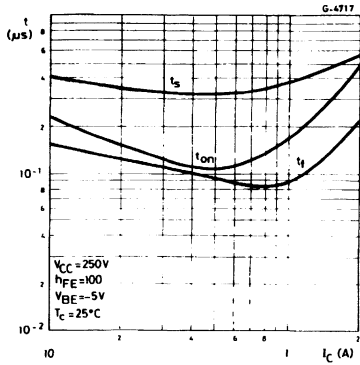

Saturated Switching Characteristics (inductive load).

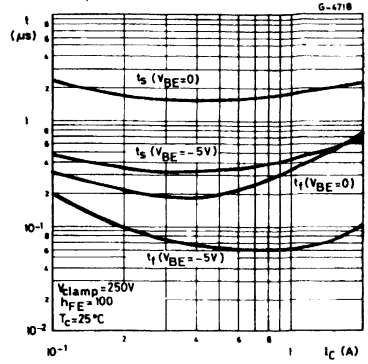

Derating Curves.

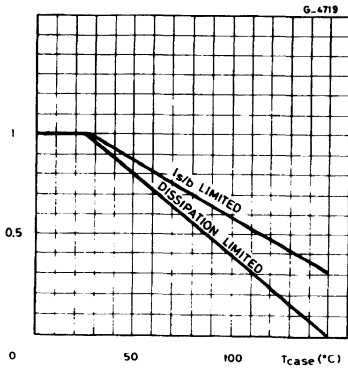

FAST SWITCHING DARLINGTON TRANSISTORS

DESCRIPTION

The BU806/807 and BU806FI/807FI are silicon epitaxial planar NPN power transistors in Darlington configuration with integrated base-emitter speed-up diode, mounted respectively in TO-220 plastic package and ISOWATT220 fully isolated package. They are high voltage, high current devices for fast switching applications. In particular they can be used in horizontal output stages of 110° CRT video displays. The BU806/FI are primarily intended for large screen, while the BU807/FI are for medium and small screens.

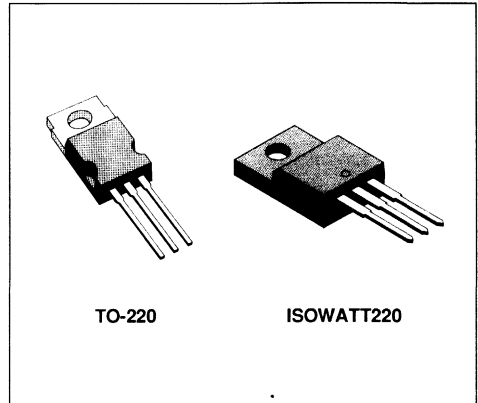

INTERNAL SCHEMATIC DIAGRAM

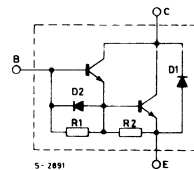

ABSOLUTE MAXIMUM RATINGS

Symbol	Parameter	BU806/FI	BU807/FI	Unit
V_{CBO}	Collector-base Voltage ($I_E = 0$)	400	330	V
V_{CEV}	Collector-emitter Voltage ($V_{BE} = -6V$)	400	330	V
V_{CEO}	Collector-emitter Voltage ($I_B = 0$)	200	150	V
V_{EBO}	Emitter-base Voltage ($I_C = 0$)	6		V
I_C	Collector Current	8		A
I_{CM}	Collector Peak Current	15		A
I_{DM}	Damper Diode Peak Forward Current	10		A
I_B	Base Current	2		A
		TO-220	ISOWATT220	
P_{tot}	Total Power Dissipation at $T_c < 25^\circ C$	60	30	W
T_{stg}	Storage Temperature	- 65 to 150		$^\circ C$
T_j	Max. Operating Junction Temperature	150		$^\circ C$

THERMAL DATA

			TO-220	ISOWATT220	
$R_{th(j-case)}$	Thermal Resistance Junction-case	Max	2.08	4.16	°C/W
$R_{th(j-amb)}$	Thermal Resistance Junction-ambient	Max	70		°C/W

ELECTRICAL CHARACTERISTICS ($T_{case} = 25^{\circ}C$ unless otherwise specified)

Symbol	Parameter	Test Conditions		Min.	Typ.	Max.	Unit
I_{CES}	Collector Cutoff Current ($V_{BE} = 0$)	for BU807/FI for BU806/FI	$V_{CE} = 330V$ $V_{CE} = 400V$			100 100	μA μA
I_{CEV}	Collector Cutoff Current ($V_{BE} = -6V$)	for BU807/FI for BU806/FI	$V_{CE} = 330V$ $V_{CE} = 400V$			100 100	μA μA
I_{EBO}	Emitter Cutoff Current ($I_C = 0$)	$V_{EB} = 6V$				3.5	mA
$V_{CEO(sus)}^*$	Collector-emitter Sustaining Voltage ($I_B = 0$)	$I_C = 100mA$	for BU807/FI for BU806/FI	150 200			V V
$V_{CE(sat)}^*$	Collector-emitter Saturation Voltage	$I_C = 5A$	$I_B = 50mA$			1.5	V
$V_{BE(sat)}^*$	Base-emitter Saturation Voltage	$I_C = 5A$	$I_B = 50mA$			2.4	V
V_F^*	Damper Diode Forward Voltage	$I_F = 4A$				2	V
t_{off}^{**}	Turn-off Time	$I_C = 5A$	$I_{B1} = 50mA$		0.4	1	μs
t_{on}	Turn-on Time	RESISTIVE LOAD			0.35		μs
t_s	Storage Time	$I_C = 5A$	$I_{B1} = 50mA$		0.55		μs
t_f	Fall Time	$I_{B2} = -500mA$	$V_{CC} = 100V$		0.2		μs

* Pulsed : pulse duration = 300 μs , duty cycle = 1.5 %.

** See Test Circuit.

Safe Operating Areas.

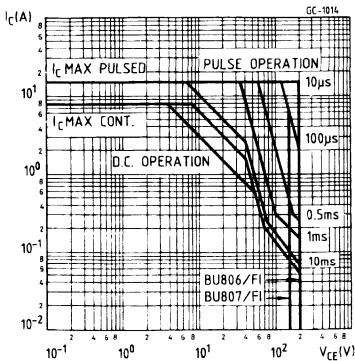

DC Current Gain.

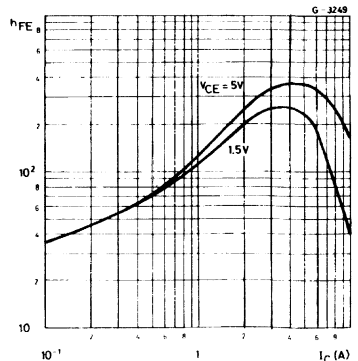

Collector-emitter Saturation Voltage.

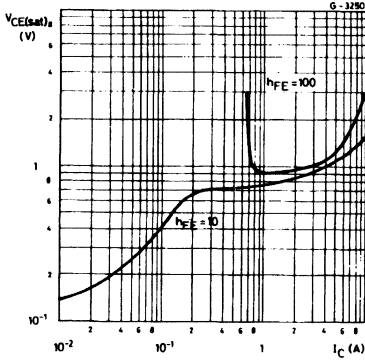

Collector-emitter Saturation Voltage.

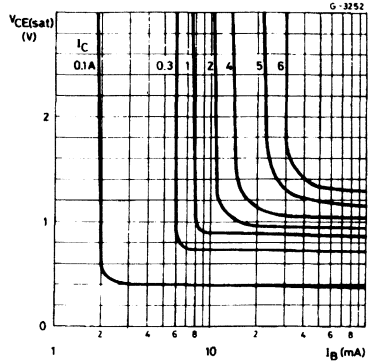

Base-emitter Saturation Voltage.

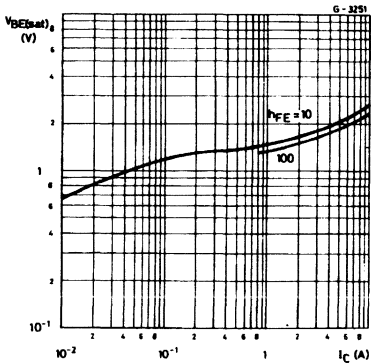

Damper Diode.

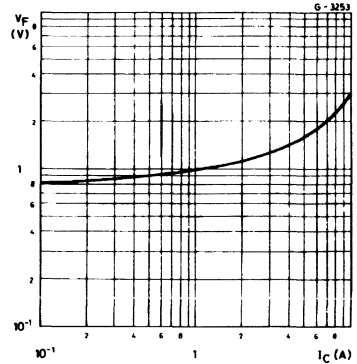

Saturated Switching Characteristics (resistive load).

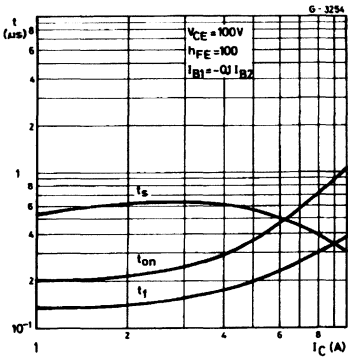

Saturated Switching Characteristics (inductive load).

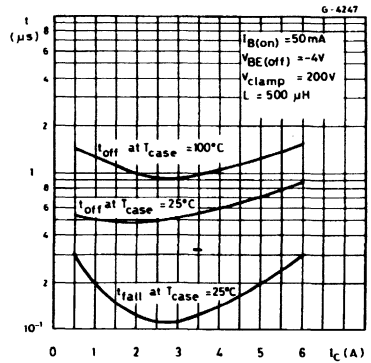

HORIZONTAL DEFLECTION TURN-OFF TIME

TEST CIRCUIT

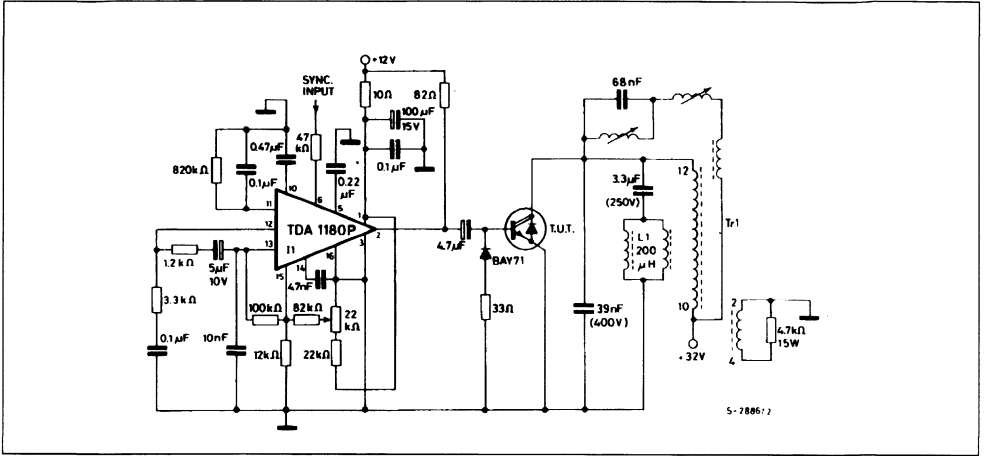

L1 = Horizontal yoke = 200 μH.
 Tr1 = EHT Transformer SAREAtype 900914 or equivalent.
 I1 = Horizontal oscillator linear I. C. TDA 1180P.

TURN-OFF TIME WAVEFORM

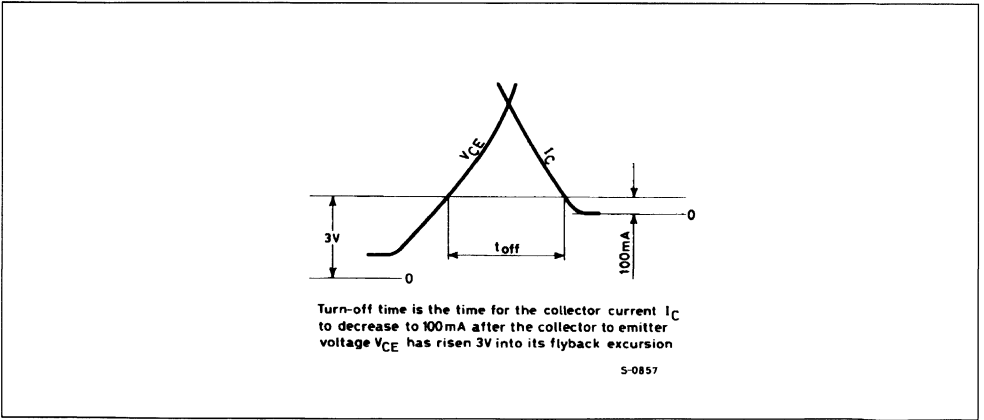

APPLICATION INFORMATION

Horizontal deflection circuit using the darlington BU806 directly driven by the TDA1180 (B & W TV set : large screen solution).

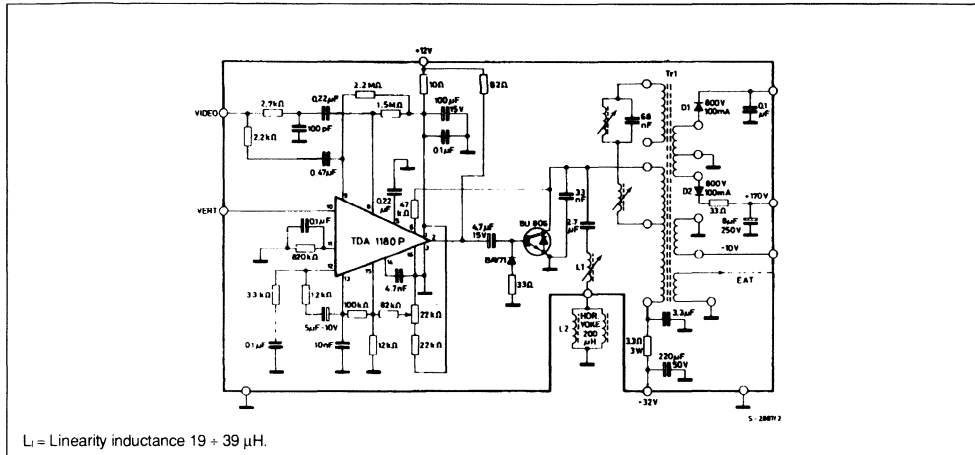

Horizontal deflection circuit using the darlington BU807 directly driven by the TDA1180 (B & W TV set : small screen solution).

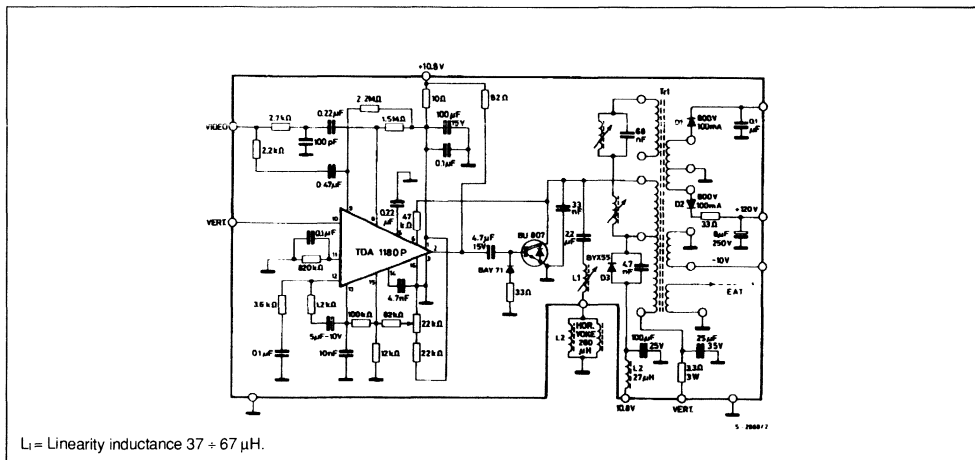

ISOWATT220 PACKAGE CHARACTERISTICS AND APPLICATION

ISOWATT220 is fully isolated to 2000V dc. Its thermal impedance, given in the data sheet, is optimised to give efficient thermal conduction together with excellent electrical isolation.

The structure of the case ensures optimum distances between the pins and heatsink. The ISOWATT220 package eliminates the need for external isolation so reducing fixing hardware.

Accurate moulding techniques used in manufacture assures consistent heat spreader-to-heatsink capacitance.

ISOWATT220 thermal performance is equivalent to that of the standard part, mounted with a 0.1mm mica washer.

The thermally conductive plastic has a higher breakdown rating and is less fragile than mica or plastic sheets. Power derating for ISOWATT220 packages is determined by :

$$P_D = \frac{T_J - T_c}{R_{th}}$$

THERMAL IMPEDANCE OF ISOWATT220 PACKAGE

Figure 1 illustrates the elements contributing to the thermal resistance of a transistor heatsink assembly, using ISOWATT220 package.

The total thermal resistance $R_{th(tot)}$ is the sum of each of these elements.

The transient thermal impedance, Z_{th} for different pulse durations can be estimated as follows :

- 1-for a short duration power pulse less than 1ms :
 $Z_{th} < R_{thJ-C}$
- 2-for an intermediate power pulse of 5ms to 50ms :
 $Z_{th} = R_{thJ-C}$

3-for long power pulses of the order of 500ms or greater :

$$Z_{th} = R_{thJ-C} + R_{thC-HS} + R_{thHS-amb}$$

It is often possible to discern these areas on transient thermal impedance curves.

Figure 1.

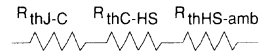

VERY HIGH VOLTAGE FAST SWITCHING POWER DARLINGTON

PRELIMINARY DATA

- HIGH VOLTAGE
- HIGH POWER
- HIGH SWITCHING SPEED
- EXCELLENT STABILITY

CONSUMER APPLICATION

- TV COLOR HORIZONTAL DEFLECTION

DESCRIPTION

The BU808FI and BU808DFI are silicon multiepitaxial mesa NPN transistors in monolithic Darlington configuration. An integrated base-emitter speed-up diode is included in the BU808DFI. They are fast switching, high voltage devices designed for use in colour television horizontal deflection circuits.

Both devices are packaged in the fully isolated ISOWATT218.

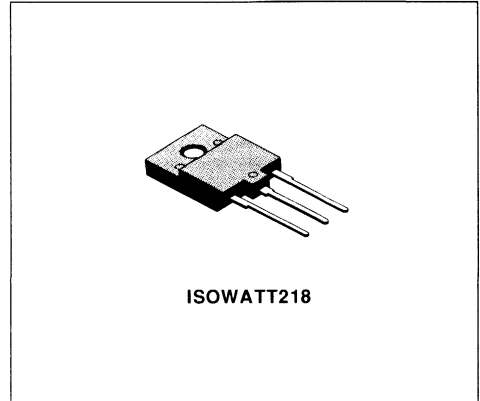

INTERNAL SCHEMATIC DIAGRAM

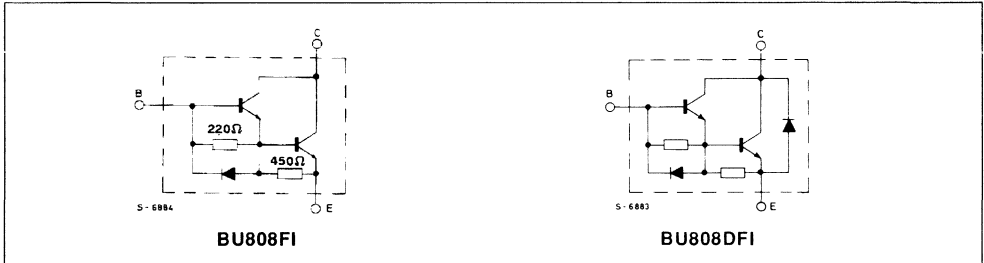

ABSOLUTE MAXIMUM RATINGS

Symbol	Parameter	Value	Unit
V_{CES}	Collector-emitter Voltage ($V_{BE} = 0$)	1400	V
V_{CEO}	Collector-emitter Voltage ($I_B = 0$)	700	V
V_{EBO}	Emitter-base Voltage ($I_C = 0$)	5	V
I_C	Collector Current	5	A
I_{CM}	Collector Peak Current ($t_p < 10\text{ms}$)	10	A
I_B	Base Current	3	A
I_{BM}	Base Peak Current ($t_p < 10\text{ms}$)	6	A
P_{tot}	Total Dissipation at $T_{amb} 25^\circ\text{C}$	50	W
T_{stg}	Storage Temperature	- 65 to 150	$^\circ\text{C}$
T_j	Max. Operating Junction Temperature	150	$^\circ\text{C}$

THERMAL DATA

$R_{thj-case}$	Thermal Resistance Junction-case	Max.	2.5	$^{\circ}C/W$
----------------	----------------------------------	------	-----	---------------

ELECTRICAL CHARACTERISTICS ($T_{case} = 25^{\circ}C$ unless otherwise specified)

Symbol	Parameter	Test Conditions		Min.	Typ.	Max.	Unit
I_{CES}	Collector Cutoff Current ($V_{BE} = 0$)	$V_{CE} = 1400V$				400	μA
I_{CEX}	Collector Cutoff Current	$V_{CE} = 1000V \quad V_{BE} = -5V$				400	μA
I_{EBO}	Emitter Cutoff Current ($I_C = 0$)	$V_{EB} = 5V$				100	mA
$V_{CE(sat)}^*$	Collector-emitter Saturation Voltage	$I_C = 5A$	$I_B = 0.5A$			1.6	V
$V_{BE(sat)}^*$	Base-emitter Saturation Voltage	$I_C = 5A$	$I_B = 0.5A$			2	V
h_{FE}^*	DC Current Gain	$I_C = 5A$ $I_C = 5A$	$V_{CE} = 5V$ $V_{CE} = 5V \quad T_C = 100^{\circ}C$	25 15			
V_F^*	Diode Forward Voltage	$I_F = 5A$ for BU808DFI				3	V
t_s	INDUCTIVE LOAD Storage Time	$I_C = 5A$	$I_{B1} = 0.5A \quad V_{CC} = 150V$			3	μs
t_f	Fall Time	$V_{BE(off)} = -5V$				0.8	μs
t_s	Storage Time	$I_C = 5A$	$I_{B1} = 0.5A \quad V_{CC} = 150V$		2		μs
t_f	Fall Time	$V_{BE(off)} = -5V$	$T_C = 100^{\circ}C$		0.8		μs

* Pulsed : Pulse duration = 300 μs , duty cycle = 1.5%.

Safe Operating Areas.

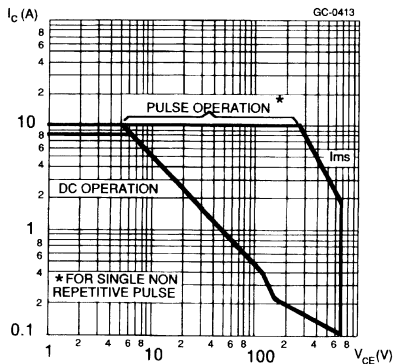

DC Current Gain.

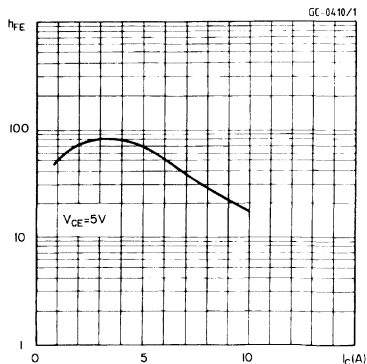

Collector Saturation Region.

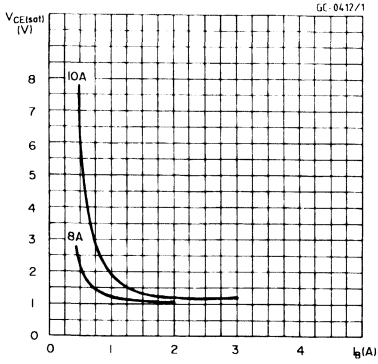

Reverse biased SOA.

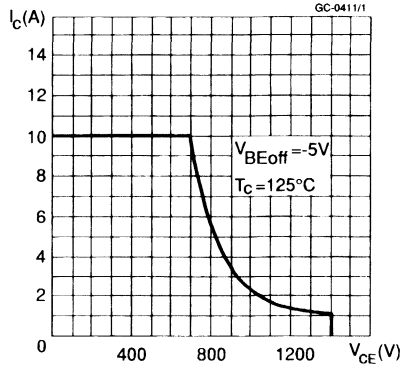

MEDIUM POWER FAST SWITCHING DARLINGTON

DESCRIPTION

The BU810 is a silicon epitaxial planar NPN Darlington transistor with integrated base-emitter speed-up diode, mounted in Jedec TO-220 plastic package. It is particularly suitable as output stage in medium power, fast switching applications.

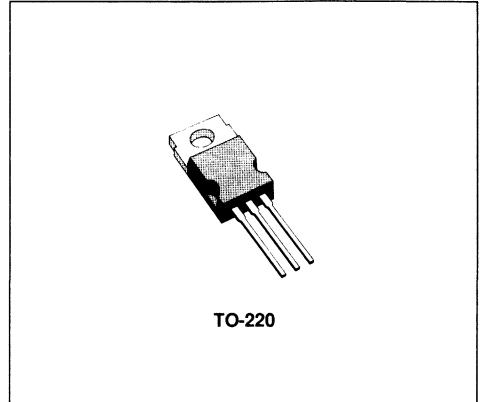

INTERNAL SCHEMATIC DIAGRAM

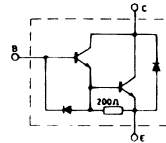

ABSOLUTE MAXIMUM RATINGS

Symbol	Parameter	Value	Unit
V_{CBO}	Collector-base Voltage ($I_E = 0$)	600	V
V_{CEO}	Collector-emitter Voltage ($I_B = 0$)	400	V
V_{EBO}	Emitter-base Voltage ($I_C = 0$)	5	V
I_C	Collector Current	7	A
I_{CM}	Collector Peak Current	10	A
I_B	Base Current	2	A
P_{Tot}	Total Power Dissipation at $T_{case} \leq 25^\circ\text{C}$	75	W
T_{stg}	Storage Temperature	- 65 to 150	$^\circ\text{C}$
T_j	Junction Temperature	150	$^\circ\text{C}$

THERMAL DATA

R _{thj-case}	Thermal Resistance Junction-case	Max	1.66	°C/W
-----------------------	----------------------------------	-----	------	------

ELECTRICAL CHARACTERISTICS (T_{case} = 25 °C unless otherwise specified)

Symbol	Parameter	Test Conditions	Min.	Typ.	Max.	Unit
I _{CES}	Collector Cutoff Current (V _{BE} = 0)	V _{CE} = 600 V			200	μA
I _{CEO}	Collector Cutoff Current (I _B = 0)	V _{CE} = 400 V			1	mA
I _{EBO} *	Emitter Cutoff Current (I _C = 0)	V _{EB} = 5 V			150	mA
V _{CEO(sus)} *	Collector-emitter Sustaining Voltage	I _C = 100 mA	400			V
V _{CE(sat)} *	Collector-emitter Saturation Voltage	I _C = 2 A I _B = 20 mA I _C = 4 A I _B = 200 mA I _C = 7 A I _B = 0.7 A			2 2.5 3	V V V
V _{BE(sat)} *	Base-emitter Saturation Voltage	I _C = 2 A I _B = 20 mA I _C = 4 A I _B = 200 mA			2.2 3	V V
V _F *	Diode Forward Voltage	I _F = 7 A			3	V

RESISTIVE SWITCHING TIMES

Symbol	Parameter	Test Conditions	Min.	Typ.	Max.	Unit.
t _{on}	Turn-on Time	V _{CC} = 250 V			0.6	μs
t _s	Storage Time	I _C = 2 A I _{B1} = 20 mA			1.5	μs
t _f	Fall Time	V _{BE(off)} = - 5 V			0.5	μs

INDUCTIVE SWITCHING TIMES

Symbol	Parameter	Test Conditions	Min.	Typ.	Max.	Unit.
t _s	Storage Time	V _{Clamp} = 250 V			1.5	μs
t _f	Fall Time	I _C = 7 A I _{B1} = 0.7 A			0.4	μs
t _s	Storage Time	V _{BE(off)} = - 5 V			1.5	μs
t _f	Fall Time				0.7	μs

* Pulsed : pulse duration = 300 ms, duty cycle = 1.5 %

Safe Operating Areas.

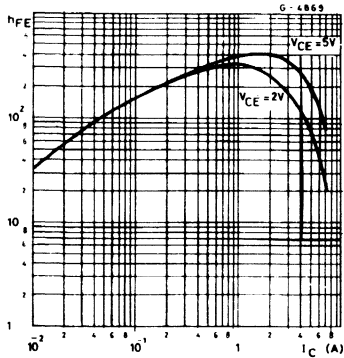

DC Current Gain.

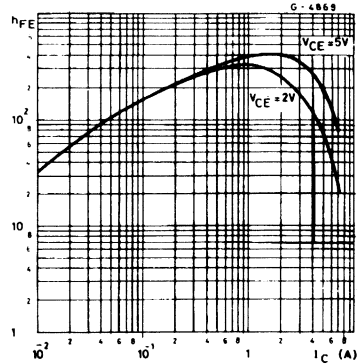

Collector-emitter Saturation Voltage.

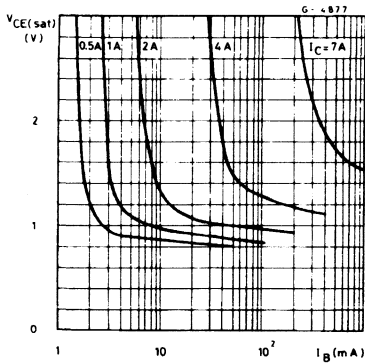

Collector-emitter Saturation Voltage.

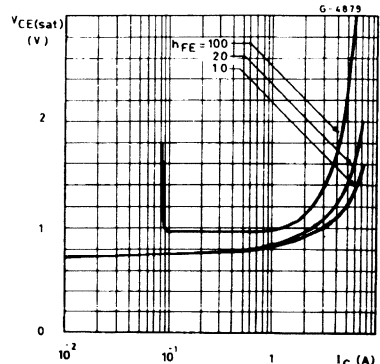

Base-emitter Saturation Voltage.

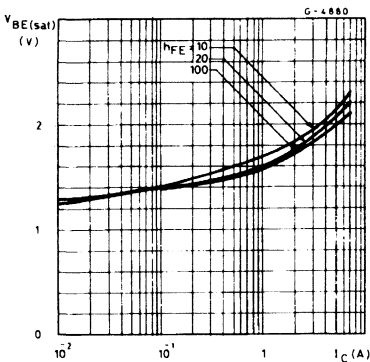

Clamped Reverse Bias Safe Operating Areas.

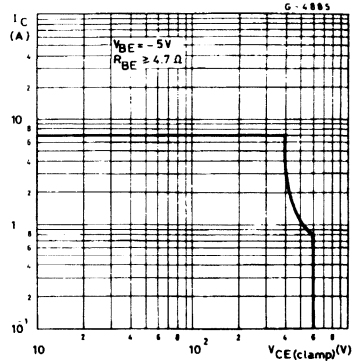

Saturated Switching Characteristics
(resistive load).

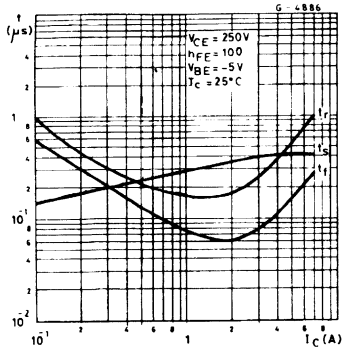

Saturated Switching Characteristics.

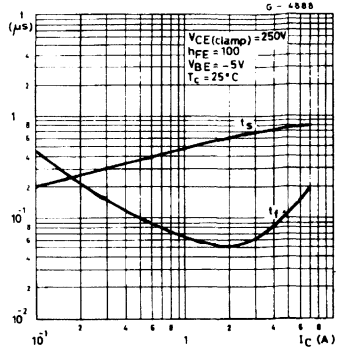

HIGH VOLTAGE POWER DARLINGTON

DESCRIPTION

The BU910, BU911, and BU912 are high voltage, silicon NPN transistors in monolithic Darlington configuration in JEDEC TO-220 plastic package, designed for applications such as electronic ignition, DC and AC motor controls, solenoid drivers, etc.

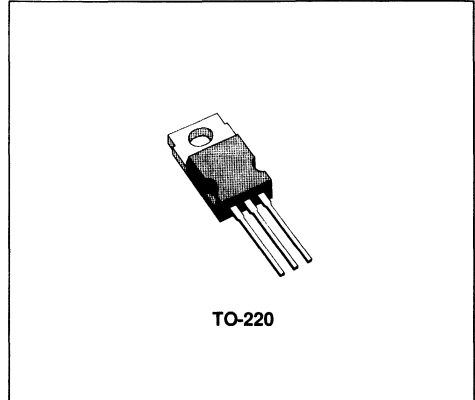

INTERNAL SCHEMATIC DIAGRAM

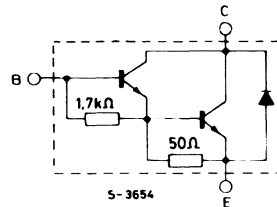

ABSOLUTE MAXIMUM RATINGS

Symbol	Parameter	Value			Unit
		BU910	BU911	BU912	
V_{CES}	Collector-emitter Voltage ($V_{BE} = 0$)	400	450	500	V
V_{CEO}	Collector-emitter Voltage ($I_B = 0$)	350	400	450	V
V_{EBO}	Emitter-base Voltage ($I_C = 0$)	5			V
I_C	Collector Current	6			A
I_{CM}	Collector Peak Current	10			A
I_B	Base Current	1			A
P_{tot}	Total Power Dissipation at $T_{case} \leq 25^\circ\text{C}$	60			W
T_{stg}	Storage Temperature	- 65 to 150			$^\circ\text{C}$
T_j	Junction Temperature	150			$^\circ\text{C}$

THERMAL DATA

$R_{th\ J-case}$	Thermal Resistance Junction-case	Max	2.08	°C/W
------------------	----------------------------------	-----	------	------

ELECTRICAL CHARACTERISTICS ($T_{case} = 25^{\circ}C$ unless otherwise specified)

Symbol	Parameter	Test Conditions	Min.	Typ.	Max.	Unit	
I_{CES}	Collector Cutoff Current ($V_{BE} = 0$)	for BU910 $V_{CE} = 400V$			1	mA	
		for BU911 $V_{CE} = 450V$			1	mA	
		for BU912 $V_{CE} = 500V$			1	mA	
		$T_{case} = 125^{\circ}C$					
		for BU910 $V_{CE} = 400V$			5	mA	
		for BU911 $V_{CE} = 450V$			5	mA	
I_{CEO}	Collector Cutoff Current ($I_B = 0$)	for BU910 $V_{CE} = 350V$			1	mA	
		for BU911 $V_{CE} = 400V$			1	mA	
		for BU912 $V_{CE} = 450V$			1	mA	
I_{EBO}	Emitter Cutoff Current ($I_C = 0$)	$V_{EB} = 5V$			5	mA	
$V_{CEO(sus)}^*$	Collector-emitter Sustaining Voltage ($I_B = 0$)	$I_C = 100mA$					
		for BU910	350			V	
		for BU911	400			V	
$V_{CE(sat)}^*$	Collector-emitter Saturation Voltage	for BU910 and BU911 $I_C = 2.5A$ $I_B = 50mA$			1.8	V	
		for BU912 $I_C = 2A$ $I_B = 50mA$			1.8	V	
		All Types $I_C = 4A$ $I_B = 200mA$			1.8	V	
$V_{BE(sat)}^*$	Base-emitter Saturation Voltage	for BU910 and BU911 $I_C = 2.5A$ $I_B = 50mA$			2.2	V	
		for BU912 $I_C = 2A$ $I_B = 50mA$			2.2	V	
		All Types $I_C = 4A$ $I_B = 200mA$			2.5	V	
V_F^*	Diode Forward Voltage	$I_F = 4A$			2.5	V	

* Pulsed : pulse duration = 300 μ s, duty cycle = 1.5%

Safe Operating Area.

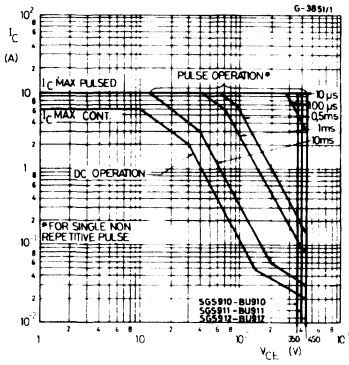

Derating Curves.

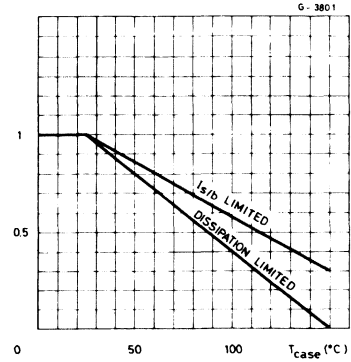

Thermal Transient Response.

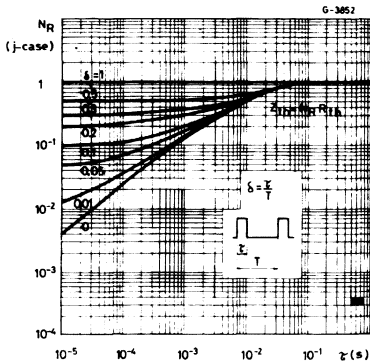

DC Current Gain.

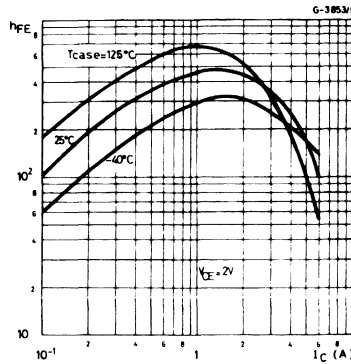

Collector-emitter Saturation Voltage.

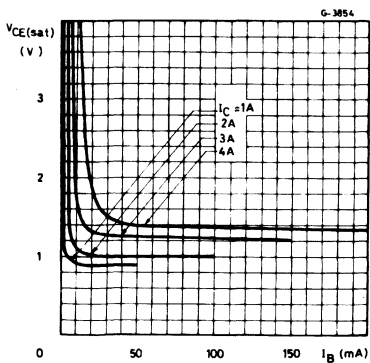

Collector-emitter Saturation Voltage.

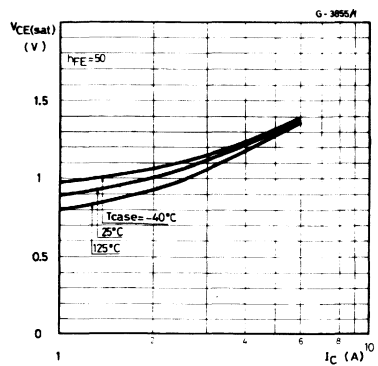

Saturated Switching Characteristics.

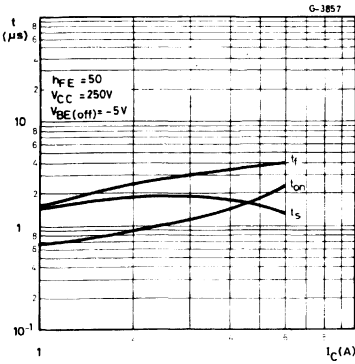

Clamped Reverse bias Safe Operating Areas.

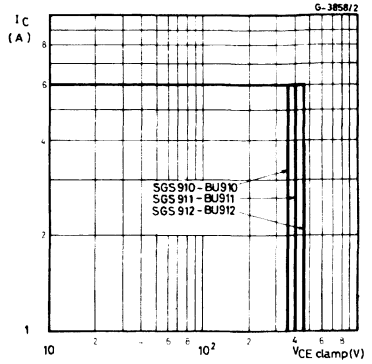

Clamped $E_{s/b}$ Test Circuit.

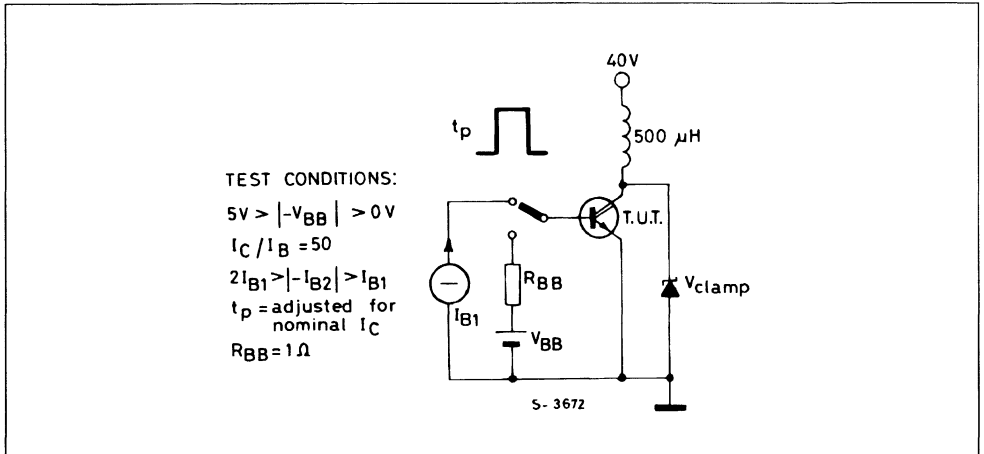

HIGH VOLTAGE POWER DISSIPATION

- HIGH VOLTAGE POWER DARLINGTON
- AUTOMOTIVE IGNITION APPLICATIONS
- HIGH CURRENT

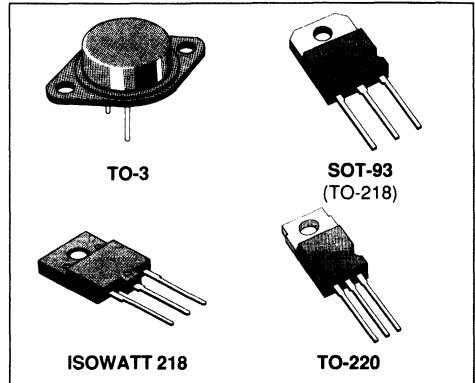

DESCRIPTION

The BU920/921/922, BU920P/921P/922P, BU920-PFI/BU921PFI/BU922PFI and BU920T/921T/922T are silicon multi-epitaxial planar NPN transistors in monolithic darlington configuration mounted respectively in Jedec TO-3 metal case, SOT-93 plastic package, ISOWATT218 fully isolated package and TO-220 plastic package.

They are particularly intended for automotive ignition applications and inverter circuits for motor control.

INTERNAL SCHEMATIC DIAGRAM

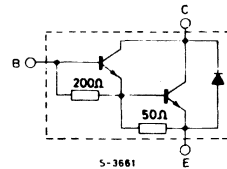

ABSOLUTE MAXIMUM RATINGS

Symbol	Parameter	Value				Unit
		TO-3 SOT-93 ISOWATT218 TO-220	BU920 BU920P BU920PFI BU920T	BU921 BU921P BU921PFI BU921T	BU922 BU922P BU922PFI BU922T	
V_{CES}	Collector-emitter Voltage ($V_{BE} = 0$)	400	450	500	V	
V_{CEO}	Collector-emitter Voltage ($I_B = 0$)	350	400	450	V	
V_{EBO}	Emitter-base Voltage ($I_C = 0$)	5				V
I_C	Collector Current	10				A
I_{CM}	Collector Peak Current	15				A
I_B	Base Current	5				A
		TO-3	SOT-93	ISOWATT218	TO-220	
P_{tot}	Total Dissipation at $T_c \leq 25^\circ\text{C}$	120	105	55	105	W
T_{stg}	Storage Temperature - 65 to	175	150	150	150	$^\circ\text{C}$
T_j	Max. Operating Junction Temperature	175	150	150	150	$^\circ\text{C}$

THERMAL DATA

$R_{th\ j-case}$	Thermal Resistance Junction-case	Max	TO-3	SOT-93	ISOWATT218	TO-220	
			1.25	1.2	2.27*	1.2	°C/W

ELECTRICAL CHARACTERISTICS ($T_{case} = 25\text{ °C}$ unless otherwise specified)

Symbol	Parameter	Test Conditions		Min.	Typ.	Max.	Unit
I_{CES}	Collector Cutoff Current ($V_{BE} = 0$)	$V_{CE} = 400\text{ V}$	for 920 Types			250	μA
		$V_{CE} = 450\text{ V}$	for 921 Types			250	μA
		$V_{CE} = 500\text{ V}$	for 922 Types			250	μA
		$V_{CE} = 400\text{ V}$	for 920 Types			0.5	mA
		$V_{CE} = 450\text{ V}$	for 921 Types			0.5	mA
		$V_{CE} = 500\text{ V}$	for 922 Types			0.5	mA
		$T_c = 150\text{ °C}$					
I_{CEO}	Collector Cutoff Current ($I_B = 0$)	$V_{CE} = 350\text{ V}$	for 920 Types			250	μA
		$V_{CE} = 400\text{ V}$	for 921 Types			250	μA
		$V_{CE} = 450\text{ V}$	for 922 Types			250	μA
I_{EBO}	Emitter Cutoff Current ($I_C = 0$)	$V_{EB} = 5\text{ V}$				50	mA
$V_{CEO(sus)}^*$	Collector-emitter Sustaining Voltage	$I_C = 100\text{ mA}$		for 920 Types	350		V
				for 921 Types	400		V
				for 922 Types	450		V
$V_{CE(sat)}^*$	Collector-emitter Saturation Voltage	$I_C = 5\text{ A}$	$I_B = 50\text{ mA}$			1.8	V
		$I_C = 7\text{ A}$	$I_B = 140\text{ mA}$			1.8	V
$V_{BE(sat)}^*$	Base-emitter Saturation Voltage	$I_C = 5\text{ A}$	$I_B = 50\text{ mA}$			2.2	V
		$I_C = 7\text{ A}$	$I_B = 140\text{ mA}$			2.5	V
V_F	Diode Forward Voltage	$I_F = 7\text{ A}$				2.5	V
	Functional Test (see test circuit Fig.2 and 3)	for 920 Types $V_{CE} = 350\text{ V}$ $L = 7\text{ mH}$		7			A
		for 921 and 922 Types $V_{CE} = 400\text{ V}$ $L = 7\text{ mH}$		7			A

* Pulsed : pulse duration = 300 μs , duty cycle = 1.5 %.

Safe Operating Areas.

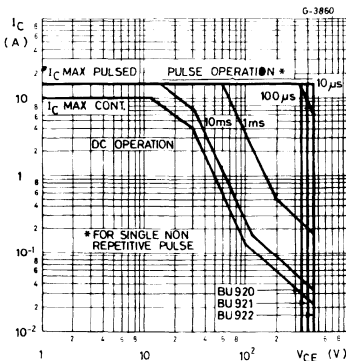

Safe Operating Areas.

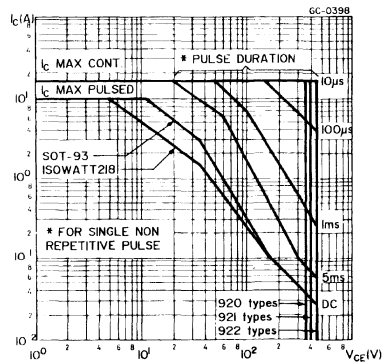

DC Current Gain.

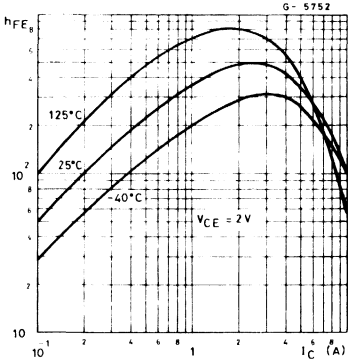

Collector-emitter Saturation Voltage.

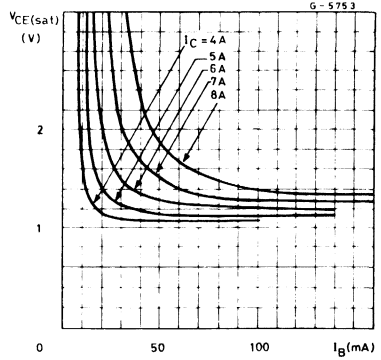

Collector-emitter Saturation Voltage.

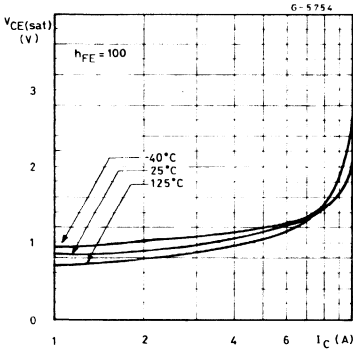

Base-emitter Saturation Voltage.

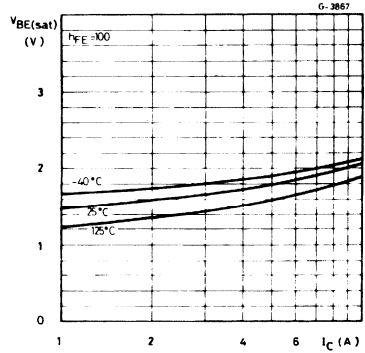

Collector-emitter Saturation Voltage.

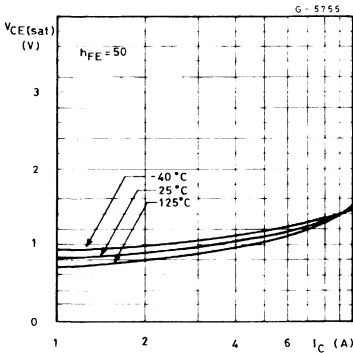

Base-emitter Saturation Voltage.

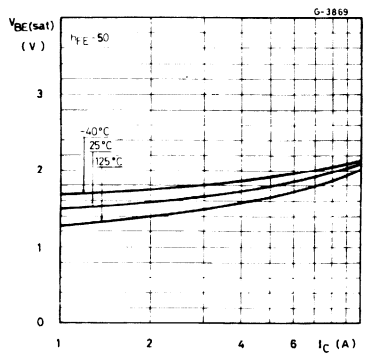

Saturated Switching Characteristics.

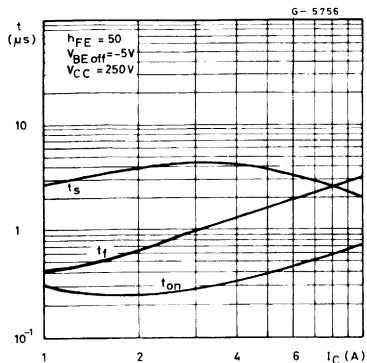
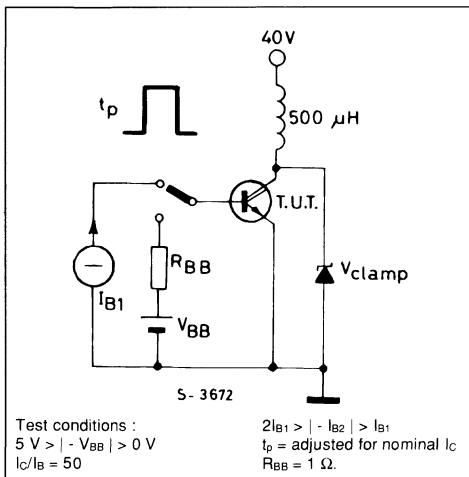

Figure 1 : Clamped $E_{S/O}$ Test Circuit.



Clamped Reverse Bias Safe Operating Areas.

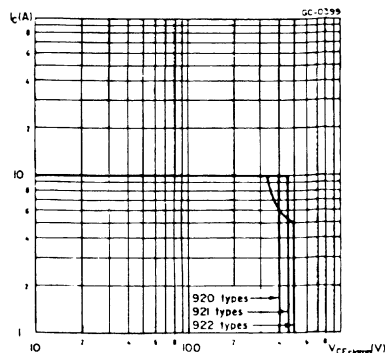

Figure 2 : Functional Test Circuit.

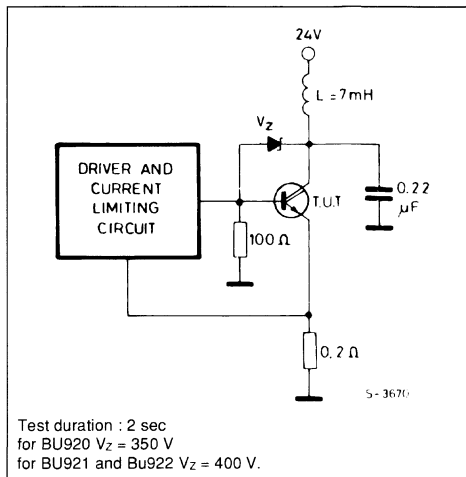
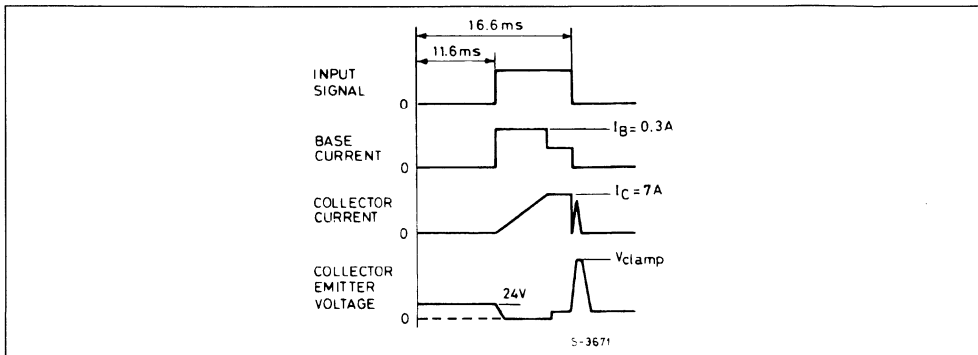

Figure 3 : Functional Test Waveforms.



ISOWATT 218 PACKAGE CHARACTERISTICS AND APPLICATION

ISOWATT218 is fully isolated to 4000 V dc. Its thermal impedance, given in the data sheet, is optimized to give efficient thermal conduction together with excellent electrical isolation.

The structure of the case ensures optimum distances between the pins and heatsink. These distances are in agreement with VDE and UL creepage and clearance standards. The ISOWATT218 package eliminates the need for external isolation so reducing fixing hardware.

The package is supplied with leads longer than the standard TO-218 to allow easy mounting on pcbs. Accurate moulding techniques used in manufacture assures consistent heat spreader-to-heatsink capacitance.

ISOWATT218 thermal performance is better than that of the standard part, mounted with a 0.1 mm mica washer. The thermally conductive plastic has a higher breakdown rating and is less fragile than mica or plastic sheets. Power derating for ISOWATT218 packages is determined by :

$$P_D = \frac{T_j - T_c}{R_{th}}$$

THERMAL IMPEDANCE OF ISOWATT 218 PACKAGE

Fig. 4 illustrates the elements contributing to the thermal resistance of transistor heatsink assembly, using ISOWATT218 package.

The total thermal resistance $R_{th(tot)}$ is the sum of each of these elements.

The transient thermal impedance, Z_{th} for different pulse durations can be estimated as follows :

1 - for a short duration power pulse less than 1 ms ;

$$Z_{th} = R_{thJ-C}$$

2 - for an intermediate power pulse of 5 ms to 50 ms :

$$Z_{th} = R_{thJ-C}$$

3 - for long power pulses of the order of 500 ms or greater :

$$Z_{th} = R_{thJ-C} + R_{thC-HS} + R_{thHS-amb}$$

It is often possible to discern these areas on transient thermal impedance curves.

Figure 4.

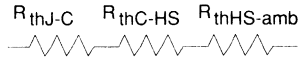

NPN POWER DARLINGTON

ADVANCE DATA

- HIGH RUGGEDNESS
- INTEGRATED HIGH VOLTAGE ZENER

AUTOMOTIVE MARKET

- APPLICATION IN HIGH PERFORMANCE ELECTRONIC CAR IGNITION

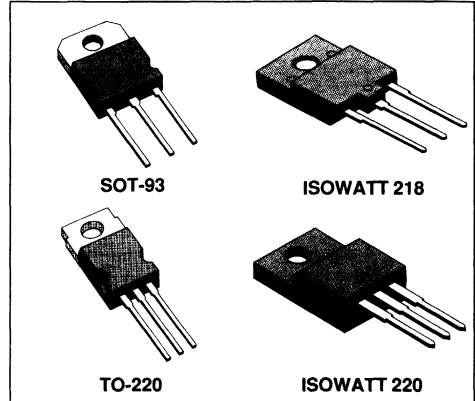

DESCRIPTION

The BU921ZP, BU921ZT, BU921ZPFI and BU921ZTFI are silicon multi-epitaxial biplanar NPN transistors in monolithic darlington configuration mounted respectively in SOT-93, TO-220 plastic packages and ISOWATT218, ISOWATT220 fully isolated packages.

INTERNAL SCHEMATIC DIAGRAM

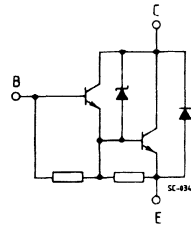

ABSOLUTE MAXIMUM RATINGS

Symbol	Parameter	Value				Unit
V_{CBO}	Collector-base Voltage ($I_E = 0$)	350				V
V_{CER}	Collector-emitter Voltage ($R_{BE} = 100 \Omega$)	350				V
V_{CES}	Collector-emitter Voltage ($V_{BE} = 0$)	350				V
V_{CEO}	Collector-emitter Voltage ($I_B = 0$)	350				V
V_{EBO}	Emitter-base Voltage ($I_C = 0$)	5				V
I_C	Collector Current	16				A
I_B	Base Current	5				A
		SOT-93	ISOWATT218	TO-220	ISOWATT220	
P_{tot}	Total Dissipation at $T_c < 25^\circ C$	125	60	100	40	W
T_{stg}	Storage Temperature	- 40 to 150				$^\circ C$
T_j	Max. Operating Junction Temperature	150				$^\circ C$

THERMAL DATA

			SOT-93	ISOWATT218	TO-220	ISOWATT220	
$R_{th\ j-case}$	Thermal Resistance Junction-case	Max	1	2.08	1.25	3.12	°C/W

ELECTRICAL CHARACTERISTICS ($T_{case} = 25\text{ °C}$ unless otherwise specified)

Symbol	Parameter	Test Conditions	Min.	Typ.	Max.	Unit
I_{CEO}	Collector Cut-off Current ($I_B = 0$)	$V_{CE} = 350\text{ V}$			250	μA
I_{EBO}	Emitter Cut-off Current ($I_C = 0$)	$V_{BE} = -5\text{ V}$			50	mA
V_{CL}	Clamping Voltage	either $I_B = 0$ or $V_{BE} = 0$ and $I_C = 100\text{ mA}$ same $T_J = 125\text{ °C}$	350 350		500 500	V V
$V_{CE(sat)}^*$	Collector-emitter Saturation Voltage	$I_C = 5\text{ A}$ $I_B = 50\text{ mA}$ $I_C = 6\text{ A}$ $I_B = 75\text{ mA}$ $I_C = 8\text{ A}$ $I_B = 120\text{ mA}$ $T_J = 125\text{ °C}$ $I_C = 5\text{ A}$ $I_B = 50\text{ mA}$ $I_C = 6\text{ A}$ $I_B = 75\text{ mA}$ $I_C = 8\text{ A}$ $I_B = 120\text{ mA}$		1.03 1.08 1.17 0.98 1.04 1.17	1.4 1.5 1.6	V V V V V V
$V_{BE(sat)}^*$	Base-emitter Saturation Voltage	$I_C = 6\text{ A}$ $I_B = 75\text{ mA}$ $I_C = 8\text{ A}$ $I_B = 120\text{ mA}$			2.2 2.3	V V
h_{FE}	DC Current Gain	$I_C = 5\text{ A}$ $V_{CE} = 10\text{ V}$	300			
V_F^*	Diode Forward Voltage	$I_F = 10\text{ A}$			2.5	V
	USE TEST	$V_{CC} = 24\text{ V}$ $L = 8\text{ mH}$	8			A

* Pulsed : pulsed duration = 300 μs , duty cycle = 1.5 %.

NPN POWER DARLINGTON

- AUTOMOTIVE MARKET
- HIGH PERFORMANCE ELECTRONIC
- IGNITION DARLINGTON
- HIGH RUGGEDNESS

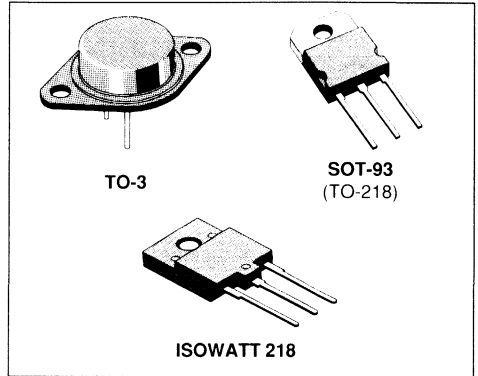

DESCRIPTION

These devices are multiepitaxial biplanar NPN transistors in monolithic darlington configuration mounted in TO-3, SOT-93 and ISOWATT218 packages. They are specially intended for automotive ignition applications and inverter circuits for motor controls. Controlled performances in the linear region make them particularly suitable for car ignitions where current limiting is achieved desaturating the darlington.

INTERNAL SCHEMATIC DIAGRAM

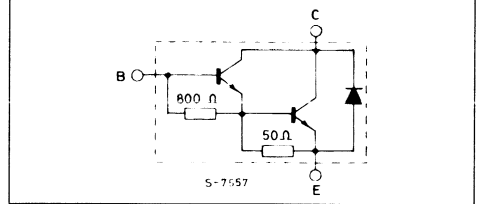

ABSOLUTE MAXIMUM RATINGS

Symbol	Parameter	Value			Unit
		TO-3 SOT-93 ISOWATT218	BU931R BU931RP BU931RPFI	BU932R BU932RP BU932RPFI	
V_{CES}	Collector-emitter Voltage ($V_{BE} = 0$)		450	500	V
V_{CEO}	Collector-emitter Voltage ($I_{BE} = 0$)		400	450	V
V_{EBO}	Emitter-base Voltage ($I_C = 0$)		5		V
I_C	Collector Current		15		A
I_{CM}	Collector Peak Current ($t_p \leq 10$ ms)		30		A
I_B	Base Current		1		A
I_{BM}	Base Peak Current ($t_p \leq 10$ ms)		5		A
		TO-3	SOT-93	ISOWATT218	
P_{tot}	Total Dissipation at $T_C \leq 25^\circ\text{C}$	175	125	60	W
T_{stg}	Storage Temperature	- 40 to 200	- 40 to 150	- 40 to 150	$^\circ\text{C}$
T_J	Max. Operating Junction Temperature	200	150	150	$^\circ\text{C}$

THERMAL DATA

			TO-3	SOT-93	ISOWATT218	
$R_{th J-case}$	Thermal Resistance Junction-case	Max	1	1	2.08*	C/W

ELECTRICAL CHARACTERISTICS ($T_{case} = 25\text{ }^{\circ}\text{C}$ unless otherwise specified)

Symbol	Parameter	Test Conditions	Min.	Typ.	Max.	Unit
I_{CES}	Collector Cutoff Current ($V_{BE} = 0$)	for BU931R/BU931RP/BU931RPFI $V_{CE} = 450\text{ V}$ $V_{CE} = 450\text{ V}$ $T_c = 125\text{ }^{\circ}\text{C}$ for BU932R/BU932RP/BU932RPFI $V_{CE} = 500\text{ V}$ $V_{CE} = 500\text{ V}$ $T_c = 125\text{ }^{\circ}\text{C}$			1 5 1 5	mA mA mA mA
I_{CEO}	Collector Cutoff Current ($I_B = 0$)	for BU931R/BU931RP/BU931RPFI $V_{CE} = 400\text{ V}$ for BU932R/BU932RP/BU932RPFI $V_{CE} = 450\text{ V}$			1 1	mA mA
I_{EBO}	Emitter Cutoff Current ($I_C = 0$)	$V_{EB} = 5\text{ V}$			50	mA
$V_{CEO(sus)}^*$	Collector-emitter Sustaining Voltage	$I_C = 100\text{ mA}$ for BU931R/BU931RP/BU931RPFI for BU932R/BU932RP/BU932RPFI	400 450			V V
$V_{CE(sat)}^*$	Collector-emitter Saturation Voltage	for BU931R/BU931RP/BU931RPFI $I_C = 7\text{ A}$ $I_B = 70\text{ mA}$ $I_C = 8\text{ A}$ $I_B = 100\text{ mA}$ $I_C = 10\text{ A}$ $I_B = 250\text{ mA}$ for BU932R/BU932RP/BU932RPFI $I_C = 8\text{ A}$ $I_B = 150\text{ mA}$		1.05 1.09 1.13 1.09	1.6 1.8 1.8 1.8	V V V V
$V_{BE(sat)}^*$	Base-emitter Saturation Voltage	for BU932R5BU932RP/BU932RPFI $I_C = 8\text{ A}$ $I_B = 100\text{ mA}$ $I_C = 10\text{ A}$ $I_B = 250\text{ mA}$ for BU932R/BU932RP/BU932RPFI $I_C = 8\text{ A}$ $I_B = 150\text{ mA}$		1.75 1.92 1.77	2.2 2.5 2.2	V V V
h_{FE}^*	DC Current Gain	$I_C = 5\text{ A}$ $V_{CE} = 10\text{ V}$	300			
V_F^*	Diode Forward Voltage	$I_F = 10\text{ A}$		1.43	2.8	V
	USE TEST (see fig. 2)	$V_{CC} = 24\text{ V}$ $V_{clamp} = 400\text{ V}$ $L = 7\text{ mH}$	8			A

INDUCTIVE LOAD

Symbol	Parameter	Test Conditions	Min.	Typ.	Max.	Unit
t_s t_f	(see fig. 3) Storage Time Fall Time	$V_{CC} = 12\text{ V}$ $V_{clamp} = 300\text{ V}$ $L = 7\text{ mH}$ $I_C = 7\text{ A}$ $I_B = 70\text{ mA}$ $V_{BE} = 0$ $R_{BE} = 47\text{ }\Omega$		15 0.5		μs μs

* Pulsed : pulse duration = 300 μs , duty cycle = 1.5 %.

Safe Operating Areas.

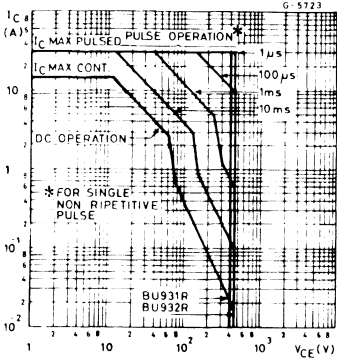

Safe Operating Areas.

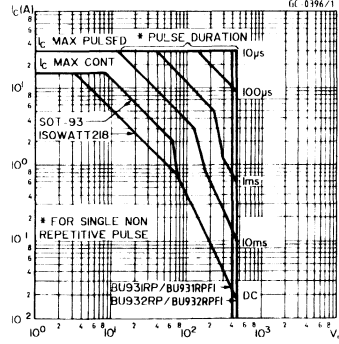

DC Current Gain.

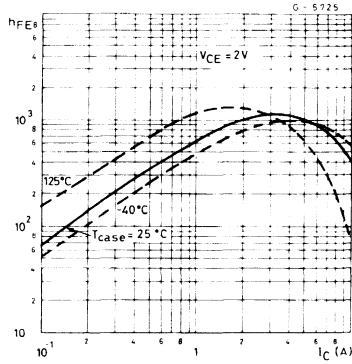

DC Current Gain.

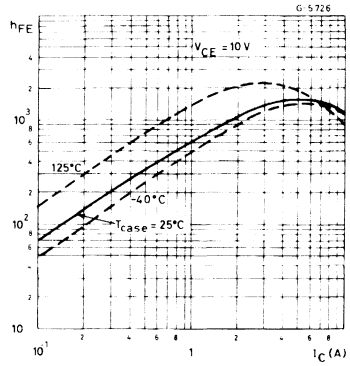

Collector-emitter Saturation Voltage.

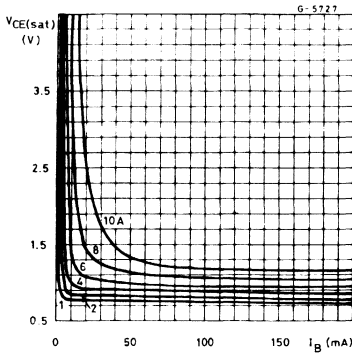

Collector-emitter Saturation Voltage.

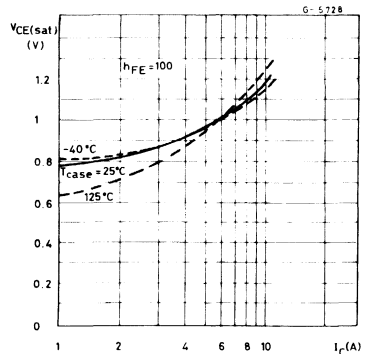

Base-emitter Saturation Voltage.

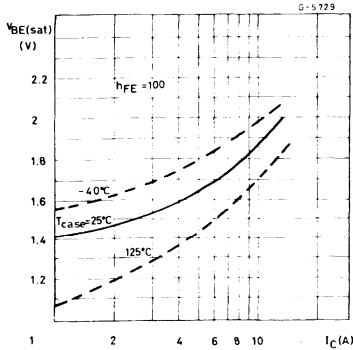

Clamped Reverse Bias Safe Operating Areas (see fig. 4).

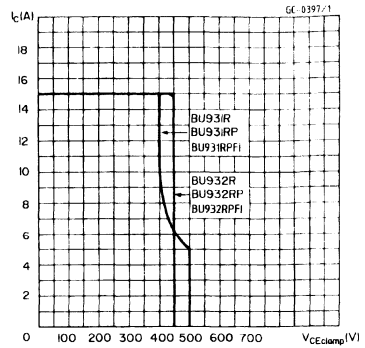

Saturated Switching Characteristics (inductive load) (see fig. 3).

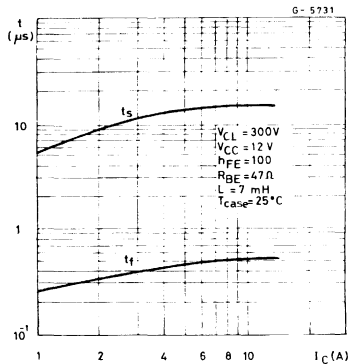

Switching Times Percentage Variation vs. Tcase Inductive Load.

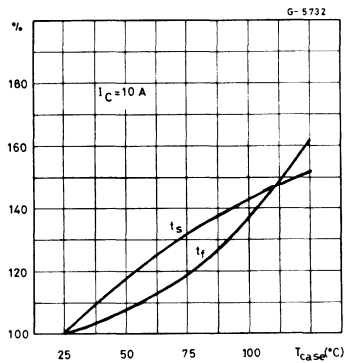

Figure 1: Functional Test Circuit.

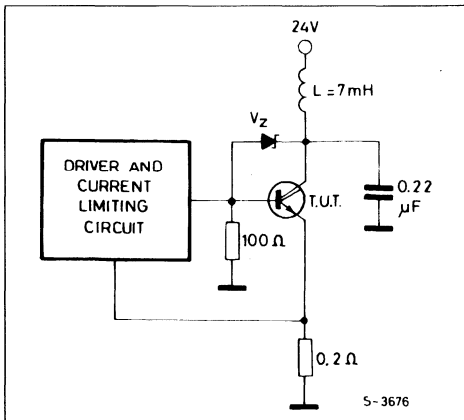

Figure 2: Functional Test Waveforms.

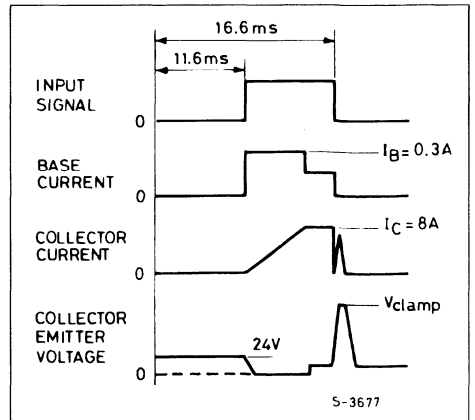

Figure 3 : Switching Times Test Circuit.

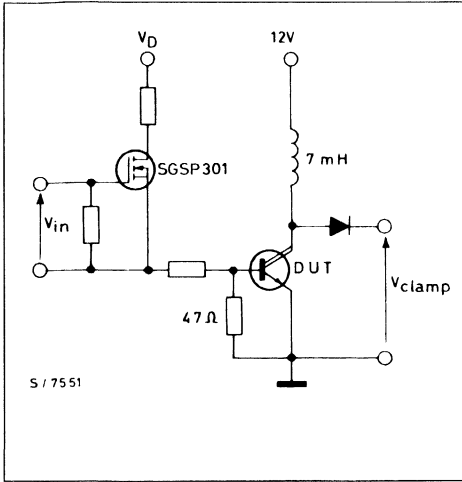
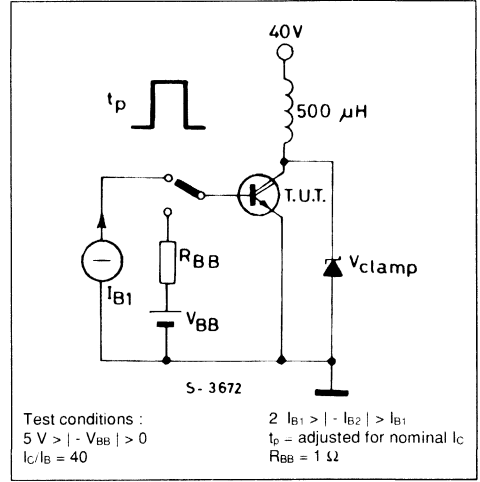

Figure 4 : Clamped E_{s/b} Test Circuit.



ISOWATT 218 PACKAGE CHARACTERISTICS AND APPLICATION

ISOWATT218 is fully isolated to 4000 V dc. Its thermal impedance, given in the data sheet, is optimised to give efficient thermal conduction together with excellent electrical isolation.

The structure of the case ensures optimum distances between the pins and heatsink. These distances are in agreement with VDE and UL creepage and clearance standards. The ISOWATT218 package eliminates the need for external isolation so reducing fixing hardware.

The package is supplied with leads longer than the standard TO-218 to allow easy mounting on pcbs. Accurate moulding techniques used in manufacture assures consistent heat spreader-to-heatsink capacitance.

ISOWATT218 thermal performance is better than that of the standard part, mounted with a 0.1 mm mica washer. The thermally conductive plastic has a higher breakdown rating and is less fragile than mica or plastic sheets. Power derating for ISOWATT218 packages is determined by :

$$P_D = \frac{T_j - T_c}{R_{th}}$$

THERMAL IMPEDANCE OF ISOWATT 218 PACKAGE

Fig. 5 illustrates the elements contributing to the thermal resistance of transistor heatsink assembly, using ISOWATT218 package.

The total thermal resistance $R_{th(tot)}$ is the sum of each of these elements.

The transient thermal impedance, Z_{th} for different pulse durations can be estimated as follows :

1. for a short duration power pulse less than 1 ms ;
 $Z_{th} < R_{thJ-C}$
2. for an intermediate power pulse of 5 ms to 50 ms ;
 $Z_{th} = R_{thJ-C}$
3. for long power pulses of the order of 500 ms or greater :

$$Z_{th} = R_{thJ-C} + R_{thC-HS} + R_{thHS-amb}$$

It is often possible to discern these areas on transient thermal impedance curves.

Figure 5

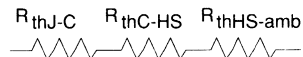

NPN POWER DARLINGTON

- HIGH RUGGEDNESS
- INTEGRATED HIGH VOLTAGE ZENER

AUTOMOTIVE MARKET

- APPLICATION IN HIGH PERFORMANCE ELECTRONIC CAR IGNITION

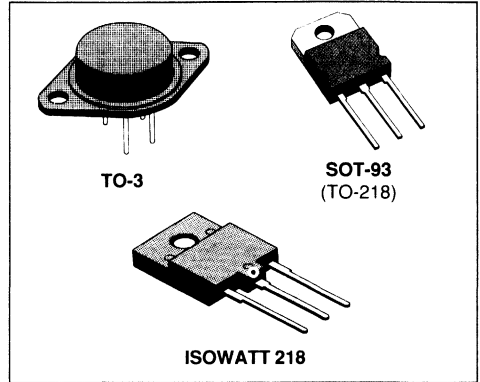
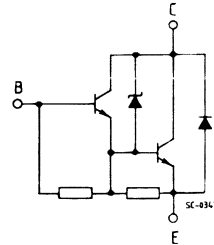
INTERNAL SCHEMATIC DIAGRAM

DESCRIPTION

The BU931Z, BU931ZP and BU931ZPFI are silicon multiepitaxial biplanar NPN transistors in monolithic darlington configuration mounted respectively in TO-3 metal case, SOT-93 plastic package and ISO-WATT218 fully isolated package.

ABSOLUTE MAXIMUM RATINGS

Symbol	Parameter	Value			Unit
V_{CBO}	Collector-base Voltage ($I_E = 0$)	350			V
V_{CER}	Collector-emitter Voltage ($R_{BE} = 100 \Omega$)	350			V
V_{CES}	Collector-emitter Voltage ($V_{BE} = 0$)	350			V
V_{CEO}	Collector-emitter Voltage ($I_B = 0$)	350			V
V_{EBO}	Emitter-base Voltage ($I_C = 0$)	5			V
I_C	Collector Current	20			A
I_B	Base Current	5			A
		TO-3	SOT-93	ISOWATT218	
P_{tot}	Total Dissipation at $T_c \leq 25^\circ\text{C}$	175	125	60	W
T_{stg}	Storage Temperature	- 40 to 200	- 40 to 150	- 40 to 150	$^\circ\text{C}$
T_j	Max. Operating Junction Temperature	200	150	150	$^\circ\text{C}$

THERMAL DATA

		TO-3	SOT-93	ISOWATT218	
$R_{th j-case}$	Thermal Resistance Junction-case	Max	1	1	2.08• °C/W

ELECTRICAL CHARACTERISTICS ($T_{case} = 25\text{ °C}$ unless otherwise specified)

Symbol	Parameter	Test Conditions	Min.	Typ.	Max.	Unit
I_{CL}	Clamping Current	$V_{CE} = 350$ either $I_B = 0$ or $V_{BE} = 0$			250 250	μA μA
$I_{CE(off)}$	Collector-emitter off State Current ($I_B = 0$)	$V_{CC} = 16\text{ V}$ $T_j = 125\text{ °C}$ $V_{BE} = 300\text{ mV}$			0.5	mA
I_{EBO}	Emitter Cutoff Current ($I_C = 0$)	$V_{EB} = 5\text{ V}$			50	mA
V_{CL}	Clamping Voltage	either $I_B = 0$ or $V_{BE} = 0$ and $I_C = 100\text{ mA}$ same $T_j = 125\text{ °C}$	350 350		500 500	V V
$V_{CE(sat)}^*$	Collector-emitter Saturation Voltage	$I_C = 7\text{ A}$ $I_B = 70\text{ mA}$ $I_C = 8\text{ A}$ $I_B = 100\text{ mA}$ $I_C = 10\text{ A}$ $I_B = 150\text{ mA}$ $T_j = 125\text{ °C}$ $I_C = 7\text{ A}$ $I_B = 70\text{ mA}$ $I_C = 8\text{ A}$ $I_B = 100\text{ mA}$ $I_C = 10\text{ A}$ $I_B = 150\text{ mA}$		1.25 1.45 1.65 1.6 1.8 2	1.6 1.8 2	V V V V V V
$V_{BE(sat)}^*$	Base-emitter Saturation Voltage	$I_C = 8\text{ A}$ $I_B = 100\text{ mA}$ $I_C = 10\text{ A}$ $I_B = 250\text{ mA}$			2.2 2.5	V V
$V_{BE(on)}^*$	Base-emitter Voltage	$I_C = 5\text{ A}$ $V_{CE} = 2\text{ V}$ $T_j = -40\text{ °C}$ $T_j = 125\text{ °C}$ $I_C = 10\text{ A}$ $V_{CE} = 2\text{ V}$ $T_j = -40\text{ °C}$ $T_j = 125\text{ °C}$	1.1 1.4	1.67 2	2.1 2.4	V V V V V
V_F^*	Diode Forward Voltage	$I_F = 10\text{ A}$			2.5	V
$E_{s/b}$	Second Breakdown Energy Unclamped	$L = 10\text{ mH}$ $I_C = 10\text{ A}$		500		mJ
$I_{s/b}$	Second Breakdown Collector Current	$V_{CE} = 30$ $t = 500\text{ ms}$ for BU931Z $t = 250\text{ ms}$ for BU931ZP $t = 250\text{ ms}$ for BU931ZPFI	6 4 1.7			A A A
	USE TEST (see fig. 2)	$V_{CC} = 24\text{ V}$ $L = 7\text{ mH}$	8			A

* Pulsed : pulse duration = 300 μs , duty cycle = 1.5 %.

Safe Operating Areas.

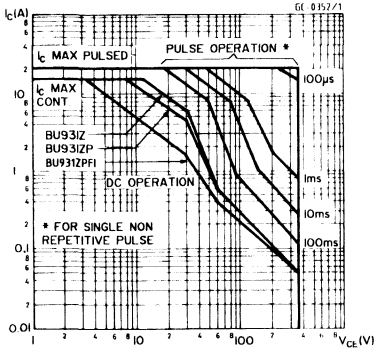

DC Current Gain.

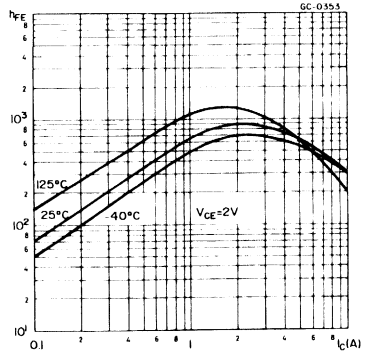

Collector-emitter Saturation Voltage.

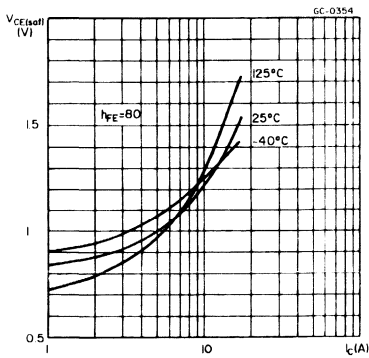

Collector-emitter Saturation Voltage.

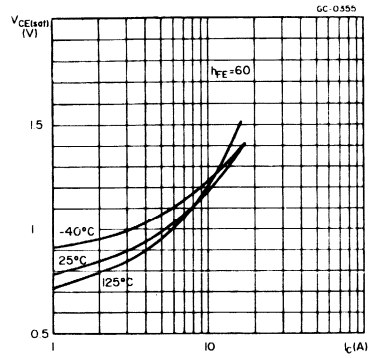

Base-emitter Saturation Voltage.

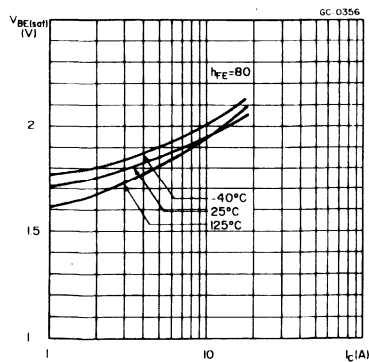

Base-emitter Saturation Voltage.

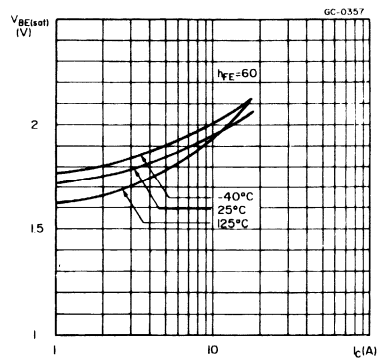

Collector-emitter Saturation Voltage.

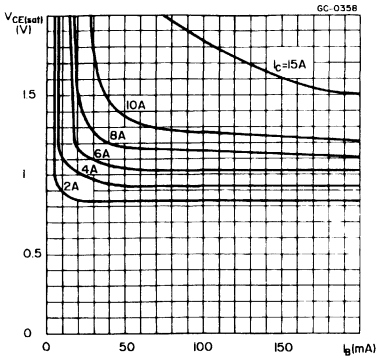

Figure 1 : Functional Test Circuit.

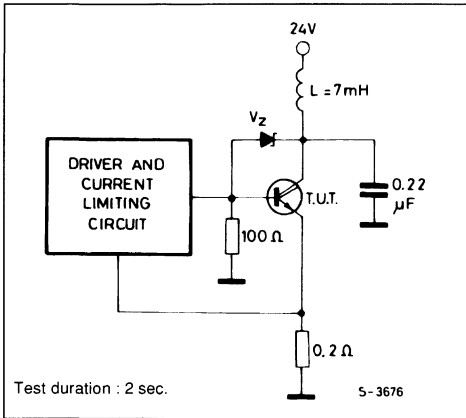
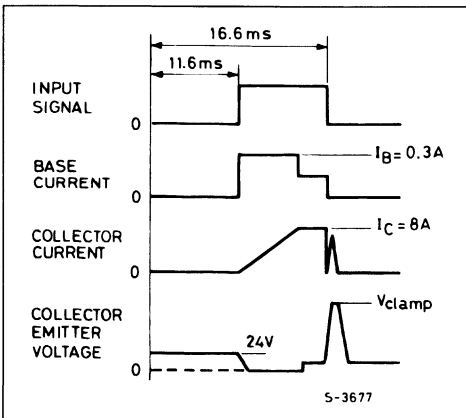

Figure 2 : Functional Test Waveforms.



ISOWATT 218 PACKAGE CHARACTERISTICS AND APPLICATION

ISOWATT218 is fully isolated to 4000 V dc. Its thermal impedance, given in the data sheet, is optimized to give efficient thermal conduction together with excellent electrical isolation.

The structure of the case ensures optimum distances between the pins and heatsink. These distances are in agreement with VDE and UL creepage and clearance standards. The ISOWATT218 package eliminates the need for external isolation so reducing fixing hardware.

The package is supplied with leads longer than the standard TO-218 to allow easy mounting on pcbs. Accurate moulding techniques used in manufacture assures consistent heat spreader-to-heatsink capacitance.

ISOWATT218 thermal performance is better than that of the standard part, mounted with a 0.1 mm mica washer. The thermally conductive plastic has a higher breakdown rating and is less fragile than mica or plastic sheets. Power derating for ISOWATT218 packages is determined by :

$$P_D = \frac{T_j - T_c}{R_{th}}$$

THERMAL IMPEDANCE OF ISOWATT 218 PACKAGE

Fig. 3 illustrates the elements contributing to the thermal resistance of transistor heatsink assembly, using ISOWATT218 package.

The total thermal resistance $R_{th(tot)}$ is the sum of each of these elements.

The transient thermal impedance, Z_{th} for different pulse durations can be estimated as follows :

1. for a short duration power pulse less than 1 ms ;
 $Z_{th} = R_{thJ-C}$
2. for an intermediate power pulse of 5 ms to 50 ms :
 $Z_{th} = R_{thJ-C}$
3. for long power pulses of the order of 500 ms or greater :

$$Z_{th} = R_{thJ-C} + R_{thC-HS} + R_{thHS-amb}$$

It is often possible to discern these areas on transient thermal impedance curves.

Figure 3.

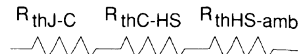

HIGH POWER FAST SWITCHING

ADVANCE DATA

DESCRIPTION

The BU1999 type is a silicon multiepitaxial planar NPN transistor and is mounted in SOT-93 plastic package. It is intended for use in switching and linear applications, and industrial equipments.



INTERNAL SCHEMATIC DIAGRAM

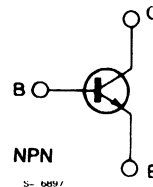

ABSOLUTE MAXIMUM RATINGS

Symbol	Parameter	Value	Unit
V_{CBO}	Collector-base Voltage ($I_E = 0$)	160	V
V_{CEO}	Collector-emitter Voltage ($I_B = 0$)	140	V
V_{EBO}	Emitter base Voltage ($I_C = 0$)	6	V
I_C	Collector Current	25	A
I_{CM}	Collector Peak Current	40	A
I_B	Base Current	10	A
P_{tot}	Total Power Dissipation at $T_{case} \leq 25^\circ\text{C}$	106	W
T_{stg}	Storage Temperature	- 65 to 150	$^\circ\text{C}$
T_j	Junction Temperature	150	$^\circ\text{C}$

THERMAL DATA

$R_{th\ J-case}$	Thermal Resistance Junction-case	Max	1.17	°C/W
------------------	----------------------------------	-----	------	------

ELECTRICAL CHARACTERISTICS ($T_{case} = 25\text{ °C}$ unless otherwise specified)

Symbol	Parameter	Test Conditions	Min.	Typ.	Max.	Unit
I_{CBO}	Collector Cutoff Current ($I_E = 0$)	$V_{CB} = 160\text{ V}$			100	μA
I_{CEO}	Collector Cutoff Current ($I_B = 0$)	$V_{CE} = 70\text{ V}$			50	μA
I_{CEX}	Collector Cutoff Current	$V_{CE} = 140\text{ V}$ $V_{BE} = -1.5\text{ V}$			10	μA
I_{EBO}	Emitter Cutoff Current	$V_{EB} = 6\text{ V}$ $I_C = 0$			100	μA
$V_{CEO(sus)}$	Collector-emitter Sustaining Voltage	$I_C = 50\text{ mA}$ $I_B = 0$	140			V
$V_{CE(sat)}^*$	Collector-emitter Saturation Voltage	$I_C = 10\text{ A}$ $I_C = 25\text{ A}$			0.8 1.5	V V
$V_{BE(sat)}^*$	Base-emitter Saturation Voltage	$I_C = 10\text{ A}$ $I_C = 25\text{ A}$			1.8 2.5	V V
$V_{BE(on)}$	Base-emitter on Voltage	$I_C = 10\text{ A}$			1.8	V
h_{FE}^*	DC Current Gain	$I_C = 0.5\text{ A}$ $I_C = 10\text{ A}$ $I_C = 25\text{ A}$	$V_{CE} = 2\text{ V}$ $V_{CE} = 2\text{ V}$ $V_{CE} = 2\text{ V}$	35 25 12	100	
t_r	Rise Time	$V_{CC} = 80\text{ V}$			0.3	μs
t_s	Storage Time	$I_C = 10\text{ A}$			1.5	μs
t_f	Fall Time	$I_{B1} = I_{B2} = 1\text{ A}$			0.25	μs

* Pulsed : pulse duration = 300 μs , duty cycle = 1.5 %.

FASTSWITCH EASY-TO-DRIVE (ETD) NPN TRANSISTORS

PRELIMINARY DATA

- HIGH SWITCHING SPEED NPN POWER TRANSISTORS
- EASY TO DRIVE
- HIGH VOLTAGE FOR OFF-LINE APPLICATIONS
- 100KHz SWITCHING SPEED
- LOW COST DRIVE CIRCUITS
- LOW DYNAMIC SATURATION

APPLICATIONS

- SMPS
- MOTOR DRIVES

DESCRIPTION

These Easy-to-Drive FASTSWITCH NPN power transistors are specially designed for high reliability

industrial and professional power driving applications such as motor drives and off-line switching power supplies. ETD transistors will operate using easy drive circuits at up to 100KHz ; this helps to simplify designs and improve reliability. The superior switching performance and low crossover losses reduce dissipation and consequently lowers the equipment operating temperature. These ETD transistors are suitable for application in high reliability, low power, motor drives and in flyback and forward converters, 100W to 250W.

These EASY-TO-DRIVE FASTSWITCH transistors are available in the TO-220 package.

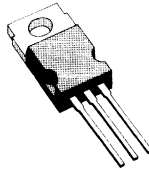

TO-220

ABSOLUTE MAXIMUM RATINGS

Symbol	Parameter	Value		Unit
		BUF405	BUF405A	
V_{CEV}	Collector-emitter Voltage ($V_{BE} = -1.5V$)	850	1000	V
V_{CEO}	Collector-emitter Voltage ($I_B = 0$)	450		V
V_{EBO}	Emitter-base Voltage ($I_C = 0$)	7		V
I_C	Collector Current	7.5		A
I_{CM}	Collector Peak Current	15		A
I_B	Base Current	3		A
I_{BM}	Base Peak Current	4.5		A
P_{tot}	Total Dissipation at $T_c < 25^\circ C$	80		W
T_{stg}	Storage Temperature	- 65 to 150		$^\circ C$
T_j	Max. Operating Junction Temperature	150		$^\circ C$

THERMAL DATA

$R_{thj-case}$	Thermal Resistance Junction-case	Max	1.56	°C/W
----------------	----------------------------------	-----	------	------

ELECTRICAL CHARACTERISTICS ($T_j = 25^\circ\text{C}$ unless otherwise specified)

Symbol	Parameter	Test Conditions	Min.	Typ.	Max.	Unit	
I_{CER}	Collector Cutoff Current ($R_{BE} = 5\Omega$)	$V_{CE} = V_{CEV}$			0.1	mA	
		$V_{CE} = V_{CEV} \quad T_c = 100^\circ\text{C}$			0.5	mA	
I_{CEV}	Collector Cutoff Current	$V_{CE} = V_{CEV} \quad V_{BE} = -1.5V$			0.1	mA	
		$V_{CE} = V_{CEV} \quad V_{BE} = -1.5V \quad T_c = 100^\circ\text{C}$			0.5	mA	
I_{EBO}	Emitter Cutoff Current ($I_C = 0$)	$V_{EB} = 5V$			1	mA	
$V_{CEO(sus)}^*$	Collector Emitter Sustaining Voltage	$I_C = 0.2A$ $L = 25mH$	450			V	
V_{EBO}	Emitter-base Voltage ($I_C = 0$)	$I_E = 50mA$	7			V	
$V_{CE(sat)}^*$	Collector-emitter Saturation Voltage	$I_C = 2.5A \quad I_B = 0.25A$		0.8		V	
		$I_C = 2.5A \quad I_B = 0.25A \quad T_c = 100^\circ\text{C}$			2.8	V	
		$I_C = 5A \quad I_B = 1A$		0.5			V
		$I_C = 5A \quad I_B = 1A \quad T_c = 100^\circ\text{C}$				2	V
$V_{BE(sat)}^*$	Base-emitter Saturation Voltage	$I_C = 2.5A \quad I_B = 0.25A$		0.9		V	
		$I_C = 2.5A \quad I_B = 0.25A \quad T_c = 100^\circ\text{C}$			1.5	V	
		$I_C = 5A \quad I_B = 1A$		1.1			V
		$I_C = 5A \quad I_B = 1A \quad T_c = 100^\circ\text{C}$				1.5	V
di_c/dt	Rate of Rise of on-state Collector Current	$V_{CC} = 300V \quad R_C = 0 \quad t_p = 3\mu s$					
		$I_{B1} = 0.375A \quad T_j = 25^\circ\text{C}$				A/ μs	
		$I_{B1} = 0.375A \quad T_j = 100^\circ\text{C}$	30	40		A/ μs	
		$I_{B1} = 1.5A \quad T_j = 100^\circ\text{C}$	60			A/ μs	
$V_{CE}(3\mu s)$	Collector-emitter Dynamic Voltage	$V_{CC} = 300V \quad R_C = 120\Omega$					
		$I_{B1} = 0.375A \quad T_j = 25^\circ\text{C}$ $T_j = 100^\circ\text{C}$		2.1		V	
$V_{CE}(5\mu s)$	Collector-emitter Dynamic Voltage	$V_{CC} = 300V \quad R_C = 120\Omega$					
		$I_{B1} = 0.375A \quad T_j = 25^\circ\text{C}$ $T_j = 100^\circ\text{C}$		1.1		V	
t_s	Storage Time	$I_C = 2.5A \quad V_{CC} = 50V$			0.8	μs	
		$V_{BB} = -5V \quad R_{BB} = 2.4\Omega$			0.05	μs	
t_f	Fall Time	$V_{clamp} = 400V \quad I_{B1} = 0.25A$			0.08	μs	
		$L = 1mH$					
t_s	Storage Time	$I_C = 2.5A \quad V_{CC} = 50V$			1.8	μs	
		$V_{BB} = -5V \quad R_{BB} = 2.4\Omega$			0.1	μs	
t_f	Fall Time	$V_{clamp} = 400V \quad I_{B1} = 0.25A$			0.18	μs	
		$L = 1mH \quad T_j = 100^\circ\text{C}$					
t_c	Cross Over Time	$I_C = 2.5A \quad V_{CC} = 50V$					
		$V_{BB} = -5V \quad R_{BB} = 2.4\Omega$					
V_{CEW}	Maximum Collector Emitter Voltage without Snubber	$V_{clamp} = 400V \quad I_{B1} = 0.25A$	500			V	
		$L = 1mH \quad T_j = 125^\circ\text{C}$					
t_s	Storage Time	$I_C = 2.5A \quad V_{CC} = 50V$		1.5		μs	
		$V_{BB} = 0 \quad R_{BB} = 0.6\Omega$		0.04		μs	
t_f	Fall Time	$V_{clamp} = 400V \quad I_{B1} = 0.25A$		0.07		μs	
		$L = 1mH$					
t_c	Cross Over Time	$I_C = 2.5A \quad V_{CC} = 50V$					
		$V_{BB} = 0 \quad R_{BB} = 0.6\Omega$					
t_c	Cross Over Time	$V_{clamp} = 400V \quad I_{B1} = 0.25A$					
		$L = 1mH$					

ELECTRICAL CHARACTERISTICS (continued)

Symbol	Parameter	Test Conditions		Min.	Typ.	Max.	Unit
t_s	Storage Time	$I_C = 2.5A$	$V_{CC} = 50V$			3	μs
t_f	Fall Time	$V_{BB} = 0$	$R_{BB} = 0.6\Omega$			0.15	μs
t_c	Cross Over Time	$V_{clamp} = 400V$ $L = 1mH$	$I_{B1} = 0.25A$ $T_j = 100^\circ C$			0.25	μs
V_{CEW}	Maximum Collector Emitter Voltage without Snubber	$I_C = 2.5A$ $V_{BB} = 0$ $V_{clamp} = 400V$ $L = 1mH$	$V_{CC} = 50V$ $R_{BB} = 0.6\Omega$ $I_{B1} = 0.25A$ $T_j = 125^\circ C$	500			V
t_s	Storage Time	$I_C = 5A$	$V_{CC} = 50V$		1.9		μs
t_f	Fall Time	$V_{BB} = -5V$	$R_{BB} = 2.4\Omega$		0.06		μs
t_c	Cross Over Time	$V_{clamp} = 400V$ $L = 0.5mH$	$I_{B1} = 1A$		0.12		μs
t_s	Storage Time	$I_C = 5A$	$V_{CC} = 50V$			3.2	μs
t_f	Fall Time	$V_{BB} = -5V$	$R_{BB} = 2.4\Omega$			0.12	μs
t_c	Cross Over Time	$V_{clamp} = 400V$ $L = 0.5mH$	$I_{B1} = 1A$ $T_j = 100^\circ C$			0.3	μs
V_{CEW}	Maximum Collector Emitter Voltage without Snubber	$I_{Cwoff} = 7.5A$ $V_{BB} = -5V$ $L = 0.33mH$ $T_j = 125^\circ C$	$I_{B1} = 1.5A$ $V_{CC} = 50V$ $R_{BB} = 2.4\Omega$	400			V

Turn-on Switching Test Circuit.

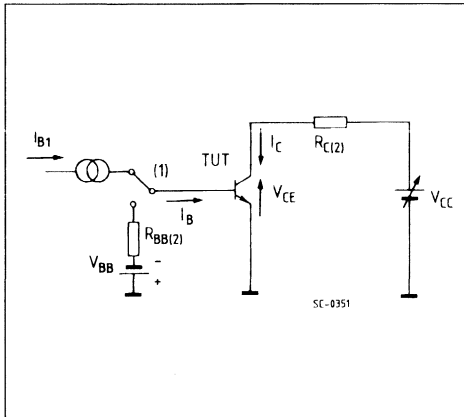

- (1) Fast electronic switch
- (2) Non-inductive Resistor

Turn-off Switching Test Circuit.

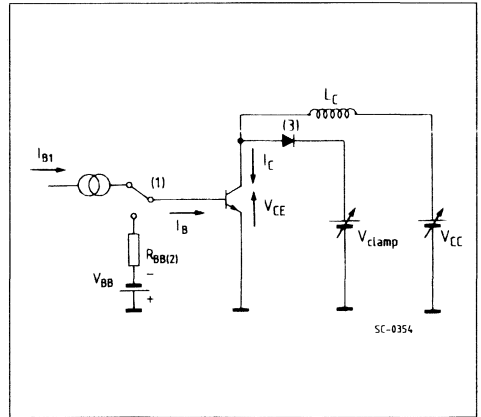

- (1) Fast electronic switch
- (2) Non-inductive Resistor
- (3) Fast recovery rectifier

Turn-on Switching Test Waveforms.

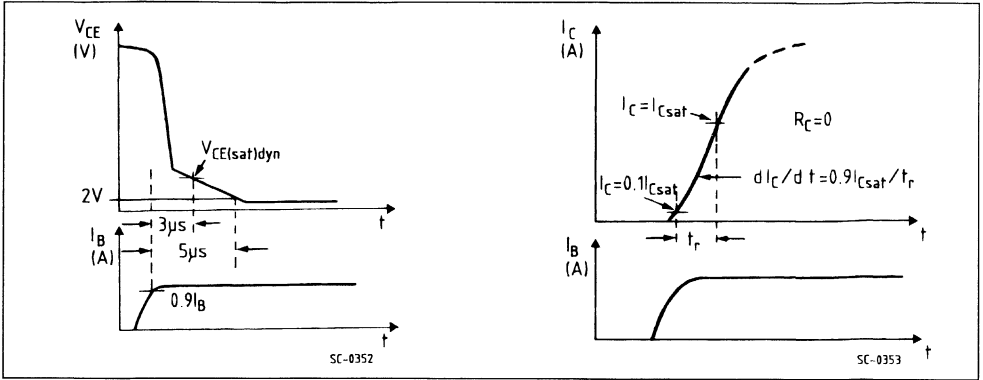

Turn-off Switching Waveforms (inductive load).

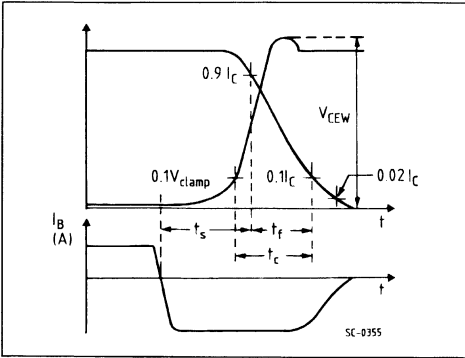

Forward Biased Safe Operating Areas.

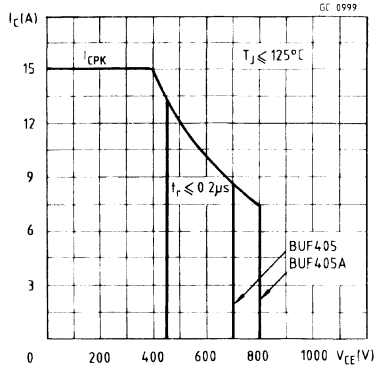

Reverse Biased Safe Operating Areas.

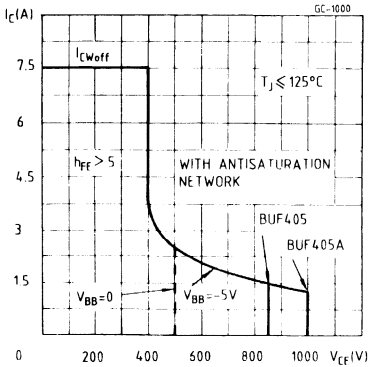

FASTSWITCH EASY-TO-DRIVE (ETD) NPN TRANSISTORS

PRELIMINARY DATA

- HIGH SWITCHING SPEED NPN POWER TRANSISTOR
- EASY TO DRIVE
- HIGH VOLTAGE FOR OFF-LINE APPLICATIONS
- 100KHz SWITCHING SPEED
- LOW COST DRIVE CIRCUITS
- LOW DYNAMIC SATURATION

APPLICATIONS

- SMPS
- MOTOR DRIVES

DESCRIPTION

These Easy-to-Drive FASTSWITCH NPN power transistors are specially designed for high reliability

industrial and professional power driving applications such as motor drives and off-line switching power supplies. ETD transistors will operate using easy drive circuits at up to 100KHz ; this helps to simplify designs and improve reliability. The superior switching performance and low crossover losses reduce dissipation and consequently lower the equipment operating temperature. These ETD transistors are suitable for applications in high reliability medium power motors drives and half bridge and full bridge converters.

These Easy-to-Drive FASTSWITCH transistors are available in TO-218 and TO-3 packages. Additionally, the alumina isolated version is available in the TOP-3I package.

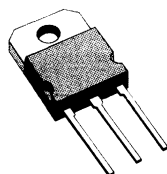

TO-218

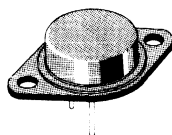

TO-3

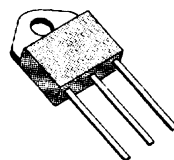

TOP-3I

ABSOLUTE MAXIMUM RATINGS

Symbol	Parameter	TO-218 TOP-3I	Value		Unit
			BUF410 BUF410I	BUF410A BUF410AI	
V_{CEV}	Collector-emitter Voltage ($V_{BE} = -1.5V$)		850	1000	V
V_{CEO}	Collector-emitter Voltage ($I_B = 0$)		450		V
V_{EBO}	Emitter-base Voltage ($I_C = 0$)		7		V
I_C	Collector Current		15		A
I_{CM}	Collector Peak Current		30		A
I_B	Base Current		3		A
I_{BM}	Base Peak Current		4.5		A
			TO-218	TOP-3I	
P_{tot}	Total Dissipation at $T_c < 25^\circ C$		125	85	W
T_{stg}	Storage Temperature		- 65 to 150		$^\circ C$
T_j	Max. Operating Junction Temperature		150		$^\circ C$

THERMAL DATA

			TO-218	TOP-31	
R _{thj-case}	Thermal Resistance Junction-case	Max	1	1.47	°C/W

ELECTRICAL CHARACTERISTICS (T_j = 25°C unless otherwise specified)

Symbol	Parameter	Test Conditions	Min.	Typ.	Max.	Unit
I _{CEr}	Collector Cutoff Current (R _{BE} = 10Ω)	V _{CE} = V _{CEV} V _{CE} = V _{CEV} T _c = 100°C			0.2 1	mA mA
I _{CEV}	Collector Cutoff Current	V _{CE} = V _{CEV} V _{BE} = - 1.5V V _{CE} = V _{CEV} V _{BE} = - 1.5V T _c = 100°C			0.2 1	mA mA
I _{EBO}	Emitter Cutoff Current (I _C = 0)	V _{EB} = 5V			1	mA
V _{CEO(sus)} *	Collector Emitter Sustaining Voltage	I _C = 0.2A L = 25mH	450			V
V _{EBO}	Emitter-base Voltage (I _C = 0)	I _E = 50mA	7			V
V _{CE(sat)} *	Collector-emitter Saturation Voltage	I _C = 5A I _B = 0.5A I _C = 5A I _B = 0.5A T _c = 100°C I _C = 10A I _B = 2A I _C = 10A I _B = 2A T _c = 100°C		0.8 0.5	2.8 2	V V V V
V _{BE(sat)} *	Base-emitter Saturation Voltage	I _C = 5A I _B = 0.5A I _C = 5A I _B = 0.5A T _c = 100°C I _C = 10A I _B = 2A I _C = 10A I _B = 2A T _c = 100°C		0.9 1.1	1.5 1.5	V V V V
di _c /dt	Rate of Rise of on-state Collector Current	V _{CC} = 300V R _C = 0 t _p = 3μs I _{B1} = 0.75A T _j = 25°C I _{B1} = 0.75A T _j = 100°C I _{B1} = 3A T _j = 100°C	45 100	60		A/μs A/μs A/μs
V _{CE(3μs)}	Collector-emitter Dynamic Voltage	V _{CC} = 300V R _C = 60Ω I _{B1} = 0.75A T _j = 25°C T _j = 100°C		2.1	8	V V
V _{CE(5μs)}	Collector-emitter Dynamic Voltage	V _{CC} = 300V R _C = 60Ω I _{B1} = 0.75A T _j = 25°C T _j = 100°C		1.1	4	V V
t _s t _f t _c	Storage Time Fall Time Cross Over Time	I _C = 5A V _{CC} = 50V V _{BB} = - 5V R _{BB} = 1.2Ω V _{clamp} = 400V I _{B1} = 0.5A L = 0.5mH		0.8 0.05 0.08		μs μs μs
t _s t _f t _c	Storage Time Fall Time Cross Over Time	I _C = 5A V _{CC} = 50V V _{BB} = - 5V R _{BB} = 1.2Ω V _{clamp} = 400V I _{B1} = 0.5A L = 0.5mH T _j = 100°C			1.8 0.1 0.18	μs μs μs
V _{CEW}	Maximum Collector Emitter Voltage without Snubber	I _C = 5A V _{CC} = 50V V _{BB} = - 5V R _{BB} = 1.2Ω V _{clamp} = 400V I _{B1} = 0.5A L = 0.5mH T _j = 125°C	500			V
t _s t _f t _c	Storage Time Fall Time Cross Over Time	I _C = 5A V _{CC} = 50V V _{BB} = 0 R _{BB} = 0.3Ω V _{clamp} = 400V I _{B1} = 0.5A L = 0.5mH		1.5 0.04 0.07		μs μs μs

ELECTRICAL CHARACTERISTICS (continued)

Symbol	Parameter	Test Conditions		Min.	Typ.	Max.	Unit
t_s	Storage Time	$I_C = 5A$	$V_{CC} = 50V$			3	μs
t_f	Fall Time	$V_{BB} = 0$	$R_{BB} = 0.3\Omega$			0.15	μs
t_c	Cross Over Time	$V_{clamp} = 400V$ $L = 0.5mH$	$I_{B1} = 0.5A$ $T_J = 100^\circ C$			0.25	μs
V_{CEW}	Maximum Collector Emitter Voltage without Snubber	$I_C = 5A$ $V_{BB} = 0$ $V_{clamp} = 400V$ $L = 0.5mH$	$V_{CC} = 50V$ $R_{BB} = 0.3\Omega$ $I_{B1} = 0.5A$ $T_J = 125^\circ C$	500			V
t_s	Storage Time	$I_C = 10A$	$V_{CC} = 50V$		1.9		μs
t_f	Fall Time	$V_{BB} = -5V$	$R_{BB} = 1.2\Omega$		0.06		μs
t_c	Cross Over Time	$V_{clamp} = 400V$ $L = 0.25mH$	$I_{B1} = 2A$		0.12		μs
t_s	Storage Time	$I_C = 10A$	$V_{CC} = 50V$			3.2	μs
t_f	Fall Time	$V_{BB} = -5V$	$R_{BB} = 1.2\Omega$			0.12	μs
t_c	Cross Over Time	$V_{clamp} = 400V$ $L = 0.25mH$	$I_{B1} = 2A$ $T_J = 100^\circ C$			0.3	μs
V_{CEW}	Maximum Collector Emitter Voltage without Snubber	$I_{Coff} = 15A$ $V_{BB} = -5V$ $L = 0.17mH$ $T_J = 125^\circ C$	$I_{B1} = 3A$ $V_{CC} = 50V$ $R_{BB} = 1.2\Omega$	400			V

Turn-on Switching Test Circuit.

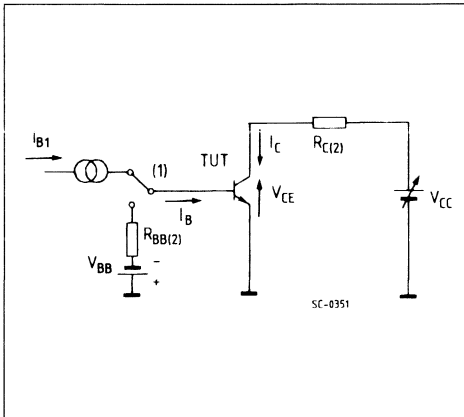

- (1) Fast electronic switch
- (2) Non-inductive Resistor

Turn-off Switching Test Circuit.

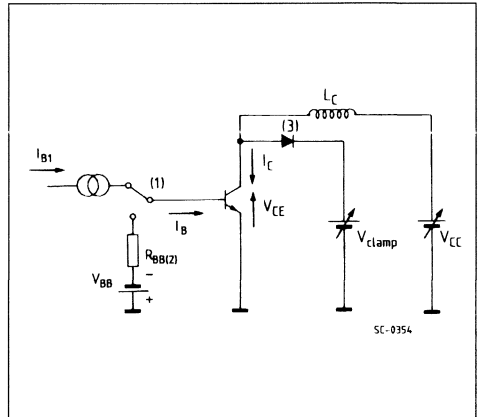

- (1) Fast electronic switch
- (2) Non-inductive Resistor
- (3) Fast recovery rectifier

Turn-on Switching Test Waveforms.

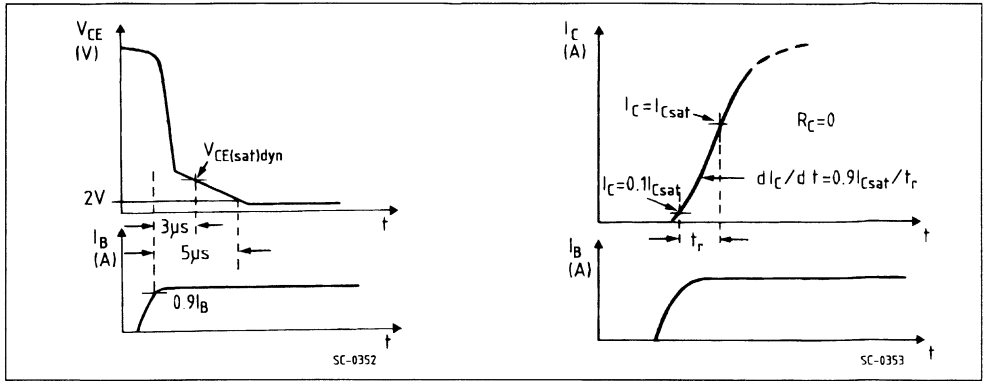

Turn-off Switching Waveforms (inductive load).

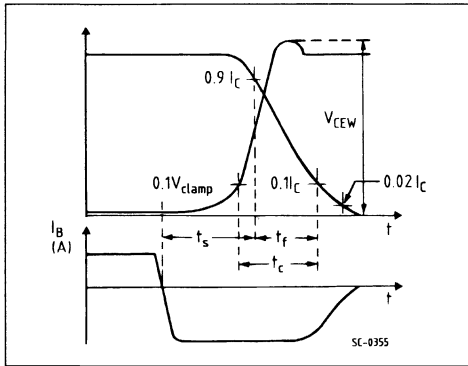

Forward Biased Safe Operating Areas.

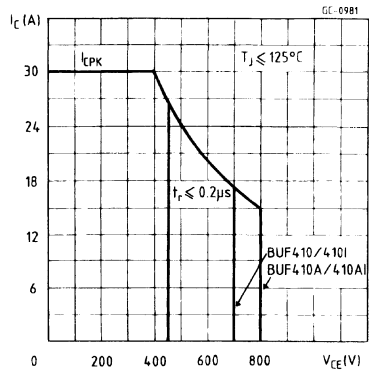

Reverse Biased Safe Operating Areas.

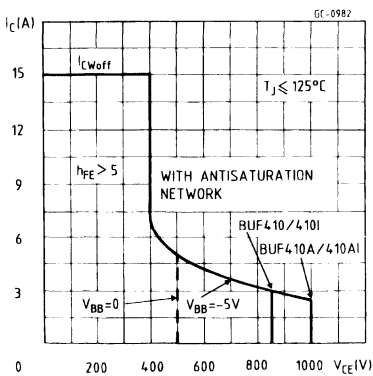

Storage Time Versus Pulse Time.

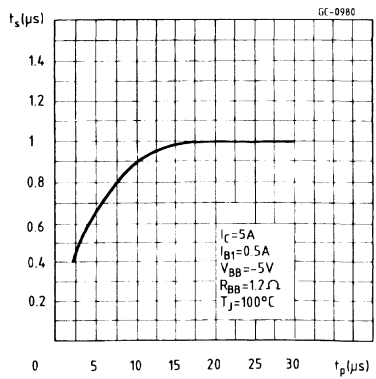

FASTSWITCH EASY-TO-DRIVE (ETD) NPN TRANSISTORS

PRELIMINARY DATA

- HIGH SWITCHING SPEED NPN POWER TRANSISTORS
- EASY TO DRIVE
- HIGH VOLTAGE FOR OFF-LINE APPLICATIONS
- 100KHz SWITCHING SPEED
- LOW COST DRIVE CIRCUITS
- LOW DYNAMIC SATURATION

APPLICATIONS

- SMPS
- MOTOR DRIVES

DESCRIPTION

These Easy-to-Drive FASTSWITCH NPN power transistors are specially designed for high reliability

industrial and professional power driving applications such as motor drives and off-line switching power supplies. ETD transistors will operate using easy drive circuits at up to 100KHz ; this helps to simplify designs and improve reliability. The superior switching performance and low crossover losses reduce dissipation and consequently lower the equipment operating temperature. These ETD transistors are suitable for application in high power, high reliability, motor drives and half bridge and full bridge converters.

These Easy-To-Drive FASTSWITCH transistors are available in TO-218 and TO-3 packages. Additionally, the alumina isolated version is available in the TOP-3I package.

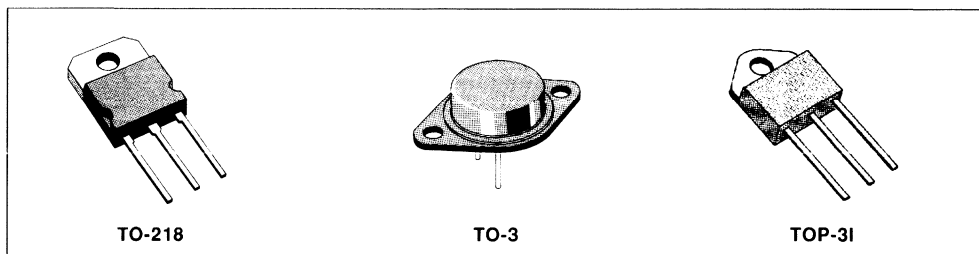

ABSOLUTE MAXIMUM RATINGS

Symbol	Parameter	TO-218 TOP-3I TO-3	Value			Unit
			BUF420 BUF420I BUF420M	TO-3	TO-218	
V_{CEV}	Collector-emitter Voltage ($V_{BE} = -1.5V$)		850		1000	V
V_{CEO}	Collector-emitter Voltage ($I_B = 0$)		450			V
V_{EBO}	Emitter-base Voltage ($I_C = 0$)		7			V
I_C	Collector Current		30			A
I_{CM}	Collector Peak Current		60			A
I_B	Base Current		6			A
I_{BM}	Base Peak Current		9			A
			TO-3	TO-218	TOP-3I	
P_{Tot}	Total Dissipation at $T_c < 25^\circ C$		200	200	115	W
T_{stg}	Storage Temperature		- 65 to 150			$^\circ C$
T_j	Max. Operating Junction Temperature		150			$^\circ C$

THERMAL DATA

			TO-3	TO-218	TOP-3I	
$R_{thj-case}$	Thermal Resistance Junction-case	Max	0.63	0.63	1.09	°C/W

ELECTRICAL CHARACTERISTICS ($T_j = 25^\circ\text{C}$ unless otherwise specified)

Symbol	Parameter	Test Conditions	Min.	Typ.	Max.	Unit
I_{CER}	Collector Cutoff Current ($R_{BE} = 5\Omega$)	$V_{CE} = V_{CEV}$			0.2	mA
		$V_{CE} = V_{CEV}$ $T_c = 100^\circ\text{C}$			1	mA
I_{CEV}	Collector Cutoff Current	$V_{CE} = V_{CEV}$ $V_{BE} = -1.5\text{V}$			0.2	mA
		$V_{CE} = V_{CEV}$ $V_{BE} = -1.5\text{V}$ $T_c = 100^\circ\text{C}$			1	mA
I_{EBO}	Emitter Cutoff Current ($I_C = 0$)	$V_{EB} = 5\text{V}$			1	mA
$V_{CEO(sus)}^*$	Collector Emitter Sustaining Voltage	$I_C = 0.2\text{A}$ $L = 25\text{mH}$	450			V
V_{EBO}	Emitter-base Voltage ($I_C = 0$)	$I_E = 50\text{mA}$	7			V
$V_{CE(sat)}^*$	Collector-emitter Saturation Voltage	$I_C = 10\text{A}$ $I_B = 1\text{A}$		0.8		V
		$I_C = 10\text{A}$ $I_B = 1\text{A}$ $T_c = 100^\circ\text{C}$			2.8	V
		$I_C = 20\text{A}$ $I_B = 4\text{A}$		0.5		V
		$I_C = 20\text{A}$ $I_B = 4\text{A}$ $T_c = 100^\circ\text{C}$			2	V
$V_{BE(sat)}^*$	Base-emitter Saturation Voltage	$I_C = 10\text{A}$ $I_B = 1\text{A}$		0.9		V
		$I_C = 10\text{A}$ $I_B = 1\text{A}$ $T_c = 100^\circ\text{C}$			1.5	V
		$I_C = 20\text{A}$ $I_B = 4\text{A}$		1.1		V
		$I_C = 20\text{A}$ $I_B = 4\text{A}$ $T_c = 100^\circ\text{C}$			1.5	V
di_c/dt	Rate of Rise of on-state Collector Current	$V_{CC} = 300\text{V}$ $R_C = 0$ $t_p = 3\mu\text{s}$ $I_{B1} = 1.5\text{A}$ $T_j = 25^\circ\text{C}$ $I_{B1} = 1.5\text{A}$ $T_j = 100^\circ\text{C}$ $I_{B1} = 6\text{A}$ $T_j = 100^\circ\text{C}$	70 150	100		A/ μs A/ μs A/ μs
$V_{CE}(3\mu\text{s})$	Collector-emitter Dynamic Voltage	$V_{CC} = 300\text{V}$ $R_C = 30\Omega$		2.1		V
		$I_{B1} = 1.5\text{A}$ $T_j = 25^\circ\text{C}$ $T_j = 100^\circ\text{C}$			8	V
$V_{CE}(5\mu\text{s})$	Collector-emitter Dynamic Voltage	$V_{CC} = 300\text{V}$ $R_C = 30\Omega$		1.1		V
		$I_{B1} = 1.5\text{A}$ $T_j = 25^\circ\text{C}$ $T_j = 100^\circ\text{C}$			4	V
t_s	Storage Time	$I_C = 10\text{A}$ $V_{CC} = 50\text{V}$		1		μs
t_f	Fall Time	$V_{BB} = -5\text{V}$ $R_{BB} = 0.6\Omega$		0.05		μs
t_c	Cross Over Time	$V_{clamp} = 400\text{V}$ $I_{B1} = 1\text{A}$ $L = 0.25\text{mH}$		0.08		μs
t_s	Storage Time	$I_C = 10\text{A}$ $V_{CC} = 50\text{V}$			2	μs
		$V_{BB} = -5\text{V}$ $R_{BB} = 0.6\Omega$			0.1	μs
t_f	Fall Time	$V_{clamp} = 400\text{V}$ $I_{B1} = 1\text{A}$ $L = 0.25\text{mH}$ $T_j = 100^\circ\text{C}$			0.18	μs
t_c	Cross Over Time					
V_{CEW}	Maximum Collector Emitter Voltage without Snubber	$I_C = 10\text{A}$ $V_{CC} = 50\text{V}$ $V_{BB} = -5\text{V}$ $R_{BB} = 0.6\Omega$ $V_{clamp} = 400\text{V}$ $I_{B1} = 1\text{A}$ $L = 0.25\text{mH}$ $T_j = 125^\circ\text{C}$	500			V
t_s	Storage Time	$I_C = 10\text{A}$ $V_{CC} = 50\text{V}$		1.5		μs
		$V_{BB} = 0$ $R_{BB} = 0.15\Omega$		0.04		μs
		$V_{clamp} = 400\text{V}$ $I_{B1} = 1\text{A}$ $L = 0.25\text{mH}$			0.07	μs

ELECTRICAL CHARACTERISTICS (continued)

Symbol	Parameter	Test Conditions		Min.	Typ.	Max.	Unit
t_s	Storage Time	$I_C = 10A$	$V_{CC} = 50V$			3	μs
t_f	Fall Time	$V_{BB} = 0$	$R_{BB} = 0.15\Omega$			0.15	μs
t_c	Cross Over Time	$V_{clamp} = 400V$	$I_{B1} = 1A$			0.25	μs
		$L = 0.25mH$	$T_j = 100^\circ C$				
V_{CEW}	Maximum Collector Emitter Voltage without Snubber	$I_C = 10A$	$V_{CC} = 50V$	500			V
		$V_{BB} = 0$	$R_{BB} = 0.15\Omega$				
		$V_{clamp} = 400V$	$I_{B1} = 1A$				
		$L = 0.25mH$	$T_j = 125^\circ C$				
t_s	Storage Time	$I_C = 20A$	$V_{CC} = 50V$		2.2		μs
t_f	Fall Time	$V_{BB} = -5V$	$R_{BB} = 0.6\Omega$		0.06		μs
t_c	Cross Over Time	$V_{clamp} = 400V$	$I_{B1} = 4A$		0.12		μs
		$L = 0.12mH$					
t_s	Storage Time	$I_C = 20A$	$V_{CC} = 50V$			3.5	μs
t_f	Fall Time	$V_{BB} = -5V$	$R_{BB} = 0.6\Omega$			0.12	μs
t_c	Cross Over Time	$V_{clamp} = 400V$	$I_{B1} = 4A$			0.3	μs
		$L = 0.12mH$	$T_j = 125^\circ C$				
V_{CEW}	Maximum Collector Emitter Voltage without Snubber	$I_{C\text{Woff}} = 30A$	$I_{B1} = 6A$	400			V
		$V_{BB} = -5V$	$V_{CC} = 50V$				
		$L = 0.08mH$	$R_{BB} = 0.6\Omega$				
		$T_j = 125^\circ C$					

Turn-on Switching Test Circuit.

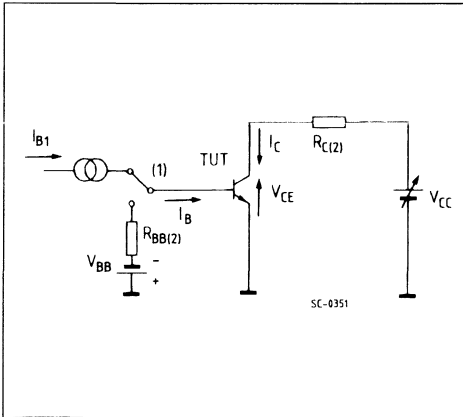

- (1) Fast electronic switch
- (2) Non-inductive Resistor

Turn-off Switching Test Circuit.

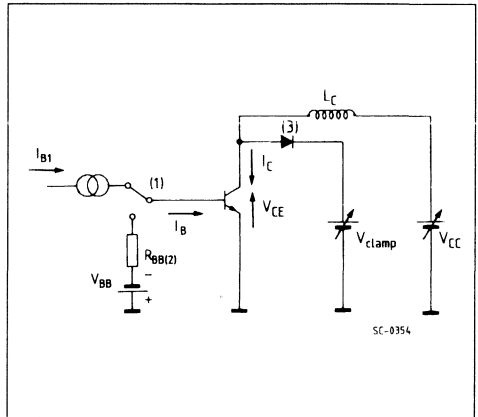

- (1) Fast electronic switch
- (2) Non-inductive Resistor
- (3) Fast recovery rectifier

Turn-on Switching Test Waveforms.

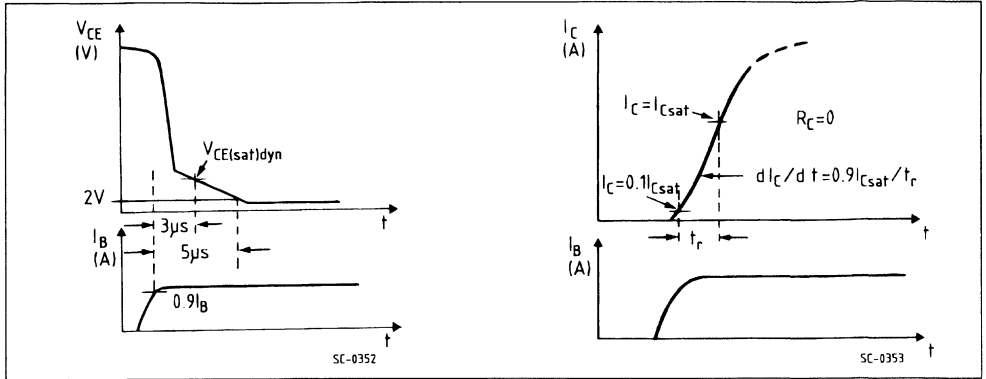

Turn-off Switching Waveforms (inductive load).

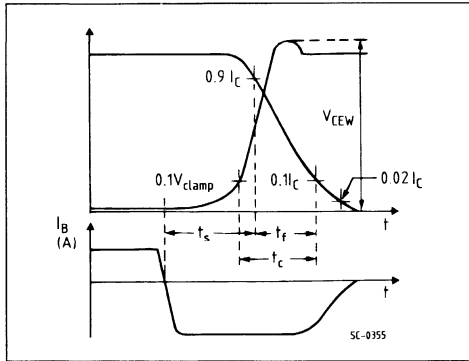

Forward Biased Safe Operating Areas.

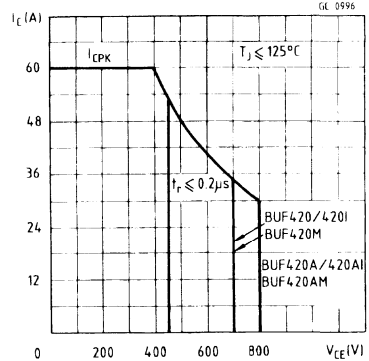

Reverse Biased Safe Operating Areas.

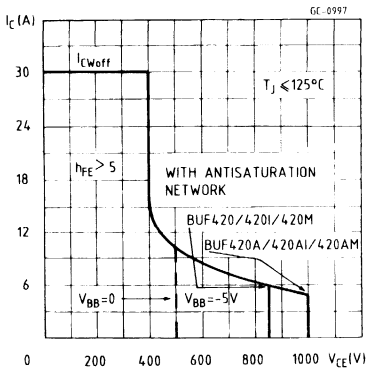

Storage Time Versus Pulse Time.

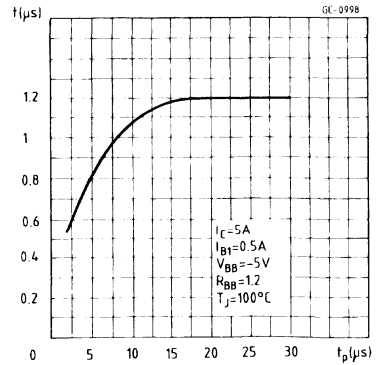

HIGH CURRENT, HIGH SPEED, HIGH POWER TRANSISTOR

ADVANCE DATA

- HIGH CURRENT
- HIGH SWITCHING SPEED
- HIGH POWER
- GOOD SOA
- GOOD RBSOA

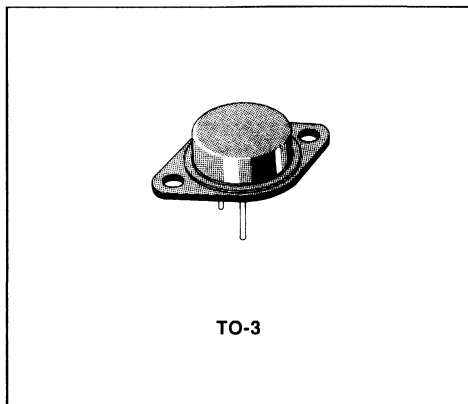

DESCRIPTION

The BUR20 is a silicon multiepitaxial planar NPN transistor in modified Jedec TO-3 metal case, intended for use in switching and linear low voltage, high current applications in military and industrial equipments.

INTERNAL SCHEMATIC DIAGRAM

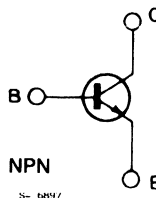

ABSOLUTE MAXIMUM RATINGS

Symbol	Parameter	Value	Unit
V_{CBO}	Collector-base Voltage ($I_E = 0$)	200	V
V_{CEX}	Collector-emitter Voltage ($V_{BE} = -1.5V$)	200	V
V_{CEO}	Collector-emitter Voltage ($I_B = 0$)	125	V
V_{EBO}	Emitter-base Voltage ($I_C = 0$)	7	V
I_C	Collector Current	50	A
I_{CM}	Collector Peak Current ($t_p < 10ms$)	75	A
I_B	Base Current	15	A
P_{tot}	Total Dissipation at $T_C < 25^\circ C$	250	W
T_{stg}	Storage Temperature	- 65 to 200	$^\circ C$
T_j	Max. Operating Junction Temperature	200	$^\circ C$

THERMAL DATA

$R_{th\ J-case}$	Thermal Resistance Junction-case	max	0.7	°C/W
------------------	----------------------------------	-----	-----	------

ELECTRICAL CHARACTERISTICS ($T_{case} = 25^{\circ}C$ unless otherwise specified)

Symbol	Parameter	Test Conditions	Min.	Typ.	Max.	Unit
I_{CEX}	Collector Cutoff Current	$V_{CE} = 200V$ $V_{BE} = -1.5V$ $V_{CE} = 200V$ $V_{BE} = -1.5V$ $T_c = 125^{\circ}C$			500 6	μA mA
I_{CEO}	Collector Cutoff Current ($I_B = 0$)	$V_{CE} = 125V$			1	mA
I_{EBO}	Emitter Cutoff Current ($I_C = 0$)	$V_{EB} = 7V$			1	mA
$V_{CEO(isus)}$ *	Collector Emitter Sustaining Voltage	$I_C = 0.2A$ $L = 25mH$	125			V
$V_{CE(sat)}$ *	Collector-emitter Saturation Voltage	$I_C = 25A$ $I_B = 2A$ $I_C = 50A$ $I_B = 5A$			1 1.5	V V
$V_{BE(sat)}$ *	Base-emitter Saturation Voltage	$I_C = 25A$ $I_B = 2A$ $I_C = 50A$ $I_B = 5A$			2 2.5	V V
h_{FE} *	DC Current Gain	$I_C = 25A$ $V_{CE} = 2V$ $I_C = 50A$ $V_{CE} = 4V$	15 10		60	
f_T	Transition Frequency	$I_C = 1A$ $V_{CE} = 15V$ $f = 10MHz$		20		MHz
t_{on} t_s t_f	RESISTIVE LOAD Turn-on Time Storage Time Fall Time	$I_C = 50A$ $I_{B1} = -I_{B2} = 5A$ $V_{CC} = 60V$ $V_{BB} = -6V$ $t_p = 10\mu s$			1.5 1.2 0.3	μs μs μs

* Pulsed : pulse duration = 300 μs , duty cycle = 1.5%.

HIGH CURRENT, HIGH SPEED, HIGH POWER TRANSISTOR

ADVANCE DATA

- HIGH CURRENT
- HIGH SWITCHING SPEED
- HIGH POWER
- GOOD SOA
- GOOD RBSOA

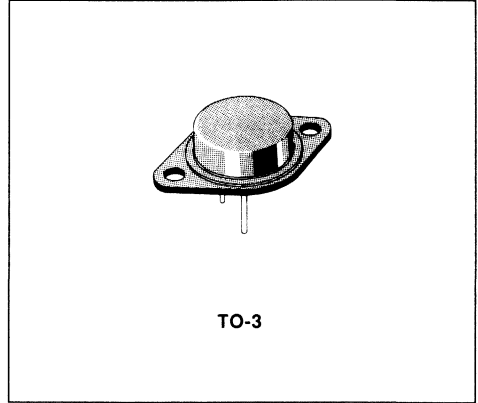

DESCRIPTION

The BUR21 is a silicon multi-epitaxial planar NPN transistor in modified Jedec TO-3 metal case, intended for use in switching and linear low voltage, high current applications in military and industrial equipments.

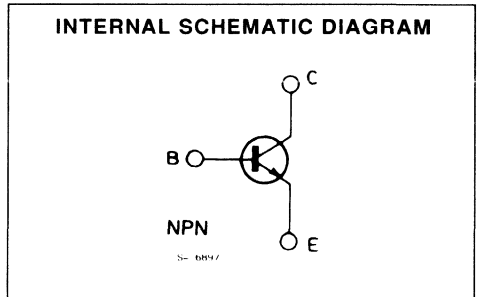

ABSOLUTE MAXIMUM RATINGS

Symbol	Parameter	Value	Unit
V_{CBO}	Collector-base Voltage ($I_E = 0$)	300	V
V_{CEX}	Collector-emitter Voltage ($V_{BE} = -1.5V$)	300	V
V_{CEO}	Collector-emitter Voltage ($I_B = 0$)	200	V
V_{EBO}	Emitter-base Voltage ($I_C = 0$)	7	V
I_C	Collector Current	40	A
I_{CM}	Collector Peak Current ($t_p < 10ms$)	50	A
I_B	Base Current	10	A
P_{tot}	Total Dissipation at $T_c < 25^\circ C$	250	W
T_{stg}	Storage Temperature	- 65 to 200	$^\circ C$
T_J	Max. Operating Junction Temperature	200	$^\circ C$

THERMAL DATA

$R_{th\ j-case}$	Thermal Resistance Junction-case	max	0.7	°C/W
------------------	----------------------------------	-----	-----	------

ELECTRICAL CHARACTERISTICS ($T_{case} = 25^{\circ}C$ unless otherwise specified)

Symbol	Parameter	Test Conditions	Min.	Typ.	Max.	Unit
I_{CEX}	Collector Cutoff Current	$V_{CE} = 300V$ $V_{BE} = -1.5V$ $V_{CE} = 300V$ $V_{BE} = -1.5V$ $T_c = 125^{\circ}C$			500 6	μA mA
I_{CEO}	Collector Cutoff Current ($I_B = 0$)	$V_{CE} = 200V$			1	mA
I_{EBO}	Emitter Cutoff Current ($I_C = 0$)	$V_{EB} = 7V$			1	mA
$V_{CEO(sus)}$ *	Collector Emitter Sustaining Voltage	$I_C = 0.2A$ $L = 25mH$	200			V
$V_{CE(sat)}$ *	Collector-emitter Saturation Voltage	$I_C = 12A$ $I_B = 1.2A$ $I_C = 25A$ $I_B = 3A$ $I_C = 30A$ $I_B = 5A$			0.6 1.5 1.5	V V V
$V_{BE(sat)}$ *	Base-emitter Saturation Voltage	$I_C = 25A$ $I_B = 3A$ $I_C = 50A$ $I_B = 5A$			1.8 2.2	V V
h_{FE} *	DC Current Gain	$I_C = 12A$ $V_{CE} = 2V$ $I_C = 25A$ $V_{CE} = 4V$	15 10		60	
f_T	Transition Frequency	$I_C = 1A$ $V_{CE} = 15V$ $f = 10MHz$		20		MHz
t_{on} t_s t_f	RESISTIVE LOAD Turn-on Time Storage Time Fall Time	$I_C = 25A$ $I_{B1} = -I_{B2} = 3A$ $V_{CC} = 100V$ $V_{BB} = -6V$ $t_p = 10\mu s$			1 1.8 0.4	μs μs μs

* Pulsed : pulse duration = 300 μs , duty cycle = 1.5%.

HIGH CURRENT, HIGH SPEED, HIGH POWER TRANSISTOR

ADVANCE DATA

- HIGH CURRENT
- HIGH SWITCHING SPEED
- HIGH POWER
- GOOD SOA
- GOOD RBSOA

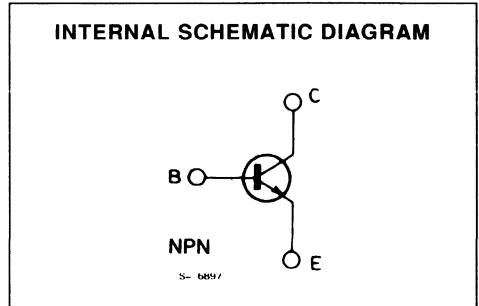
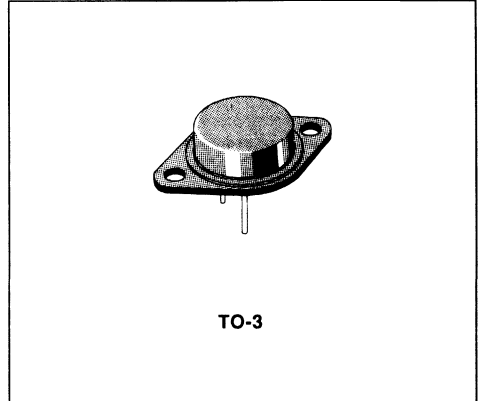
DESCRIPTION

The BUR22 is a silicon multi-epitaxial planar NPN transistor in modified Jedec TO-3 metal case, intended for use in switching and linear low voltage, high current applications in military and industrial equipments.

ABSOLUTE MAXIMUM RATINGS

Symbol	Parameter	Value	Unit
V_{CBO}	Collector-base Voltage ($I_E = 0$)	350	V
V_{CEX}	Collector-emitter Voltage ($V_{BE} = -1.5V$)	350	V
V_{CEO}	Collector-emitter Voltage ($I_B = 0$)	250	V
V_{EBO}	Emitter-base Voltage ($I_C = 0$)	7	V
I_C	Collector Current	40	A
I_{CM}	Collector Peak Current ($t_p < 10ms$)	50	A
I_B	Base Current	10	A
P_{tot}	Total Dissipation at $T_c < 25^\circ C$	250	W
T_{stg}	Storage Temperature	- 65 to 200	$^\circ C$
T_j	Max. Operating Junction Temperature	200	$^\circ C$

THERMAL DATA

R _{thj-case}	Thermal Resistance Junction-case	max	0.7	°C/W
-----------------------	----------------------------------	-----	-----	------

ELECTRICAL CHARACTERISTICS (T_{case} = 25°C unless otherwise specified)

Symbol	Parameter	Test Conditions	Min.	Typ.	Max.	Unit
I _{CEX}	Collector Cutoff Current	V _{CE} = 350V V _{BE} = - 1.5V V _{CE} = 350V V _{BE} = - 1.5V T _c = 125°C			500 6	μA mA
I _{CEO}	Collector Cutoff Current (I _B = 0)	V _{CE} = 250V			1	mA
I _{EBO}	Emitter Cutoff Current (I _C = 0)	V _{EB} = 7V			1	mA
V _{CE0(sus)} *	Collector-emitter Sustaining Voltage	I _C = 0.2A L = 25mH	250			V
V _{CE(sat)} *	Collector-emitter Saturation Voltage	I _C = 10A I _B = 1A I _C = 20A I _B = 2.5A I _C = 25A I _B = 4A			1 1.5 1.5	V V V
V _{BE(sat)} *	Base-emitter Saturation Voltage	I _C = 20A I _B = 2.5A I _C = 25A I _B = 4A			1.8 2.2	V V
h _{FE} *	DC Current Gain	I _C = 10A V _{CE} = 4V I _C = 20A V _{CE} = 4V	15 10		60	
f _T	Transition Frequency	I _C = 1A V _{CE} = 15V f = 10MHz		20		MHz
t _{on} t _s t _f	RESISTIVE LOAD Turn-on Time Storage Time Fall Time	I _C = 20A I _{B1} = - I _{B2} = 2.5A V _{CC} = 100V V _{BB} = - 6V t _p = 10μs			1 2 0.5	μs μs μs

* Pulsed : pulse duration = 300μs, duty cycle = 1.5%.

HIGH CURRENT, HIGH SPEED, HIGH POWER TRANSISTOR

DESCRIPTION

The BUR50 is a silicon multiepitaxial planar NPN transistor in modified Jedec TO-3 metal case, the BUR50S is the same type in Jedec TO-3 metal case, intended for use, in switching and linear applications in military and industrial equipment.

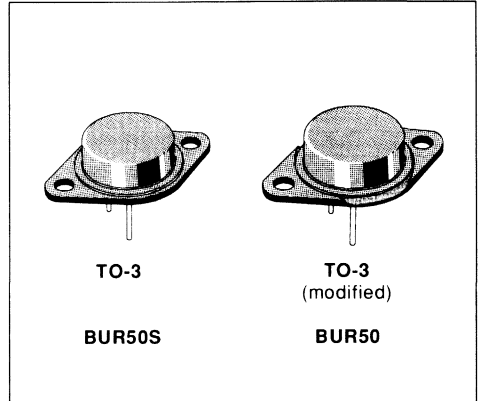

INTERNAL SCHEMATIC DIAGRAM

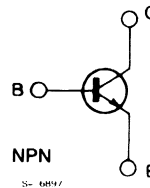

ABSOLUTE MAXIMUM RATINGS

Symbol	Parameter	Value	Unit
V_{CBO}	Collector-base Voltage ($I_E = 0$)	200	V
V_{CEO}	Collector-emitter Voltage ($I_B = 0$)	125	V
V_{EB0}	Emitter-base Voltage ($I_C = 0$)	10	V
I_C	Collector Current	70	A
I_{CM}	Collector Peak Current ($t_p = 10$ ms)	100	A
I_B	Base Current	20	A
P_{tot}	Total Power Dissipation at $T_{case} \leq 25$ °C	350	W
T_{stg}	Storage Temperature	- 65 to 200	°C
T_j	Junction Temperature	200	°C

THERMAL DATA

$R_{th\ j-case}$	Thermal Resistance Junction-case	Max	0.5	°C/W
------------------	----------------------------------	-----	-----	------

ELECTRICAL CHARACTERISTICS ($T_{case} = 25\text{ °C}$ unless otherwise specified)

Symbol	Parameter	Test Conditions		Min.	Typ.	Max.	Unit
I_{CBO}	Collector Cutoff Current ($I_E = 0$)	$V_{CB} = 200\text{ V}$ $V_{CB} = 200\text{ V}$ $T_{case} = 125\text{ °C}$				0.2 2	mA mA
I_{CEO}	Collector cutoff Current ($I_B = 0$)	$V_{CE} = 125\text{ V}$				1	mA
I_{EBO}	Emitter Cutoff Current ($I_C = 0$)	$V_{EB} = 7\text{ V}$				0.2	mA
$V_{CEO(sus)*}$	Collector-emitter Sustaining Voltage	$I_C = 200\text{ mA}$		125			V
V_{EBO}	Emitter-base Voltage ($I_C = 0$)	$I_E = 10\text{ mA}$		10			V
$V_{CE(sat)*}$	Collector-emitter Saturation Voltage	$I_C = 35\text{ A}$ $I_C = 70\text{ A}$	$I_B = 2\text{ A}$ $I_B = 7\text{ A}$		0.8	1 1.5	V V
$V_{BE(sat)*}$	Base-emitter Saturation Voltage	$I_C = 35\text{ A}$ $I_C = 70\text{ A}$	$I_B = 2\text{ A}$ $I_B = 7\text{ A}$		1.6	1.8 2	V V
h_{FE*}	DC Current Gain	$I_C = 5\text{ A}$ $I_C = 50\text{ A}$	$V_{CE} = 4\text{ V}$ $V_{CE} = 4\text{ V}$	20 15		100	
$I_{s/b}$	Second Breakdown Collector Current	$V_{CE} = 20\text{ V}$	$t = 1\text{ s}$	17.5			A
f_T	Transition Frequency	$I_C = 1\text{ A}$ $f = 1\text{ MHz}$	$V_{CE} = 5\text{ V}$	10	16		MHz
t_{on}	Turn-on Time (fig. 2)	$I_C = 70\text{ A}$ $V_{CC} = 60\text{ V}$	$I_{B1} = 7\text{ A}$		0.5	1.2	μs
t_s	Storage Time (fig. 2)	$I_C = 70\text{ A}$ $I_{B2} = -7\text{ A}$	$I_{B1} = 7\text{ A}$ $V_{CC} = 60\text{ V}$		0.82	2	μs
t_f	Fall Time (fig. 2)				0.1	0.5	μs
	Clamped $E_{s/b}$ Collector Current (fig. 1)	$V_{clamp} = 125\text{ V}$	$L = 500\text{ }\mu\text{H}$	70			A

* Pulsed : pulse duration = 300 μs , duty cycle $\leq 2\%$.

Safe Operating Areas.

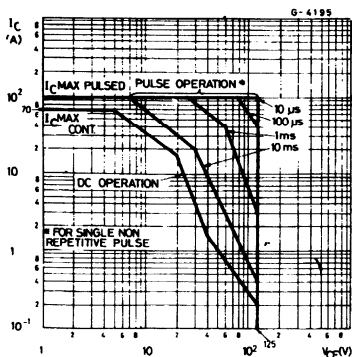

Derating Curves.

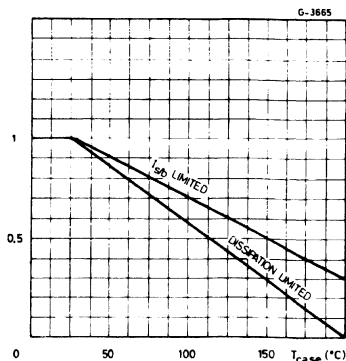

Thermal Transient Response.

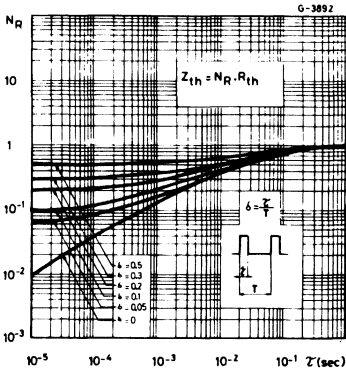

DC Current Gain.

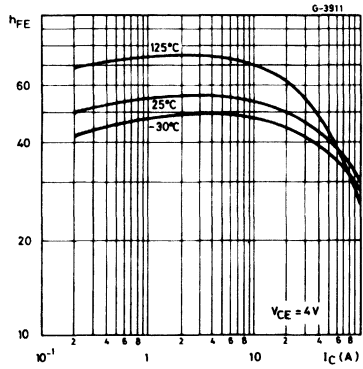

Collector-emitter Saturation Voltage.

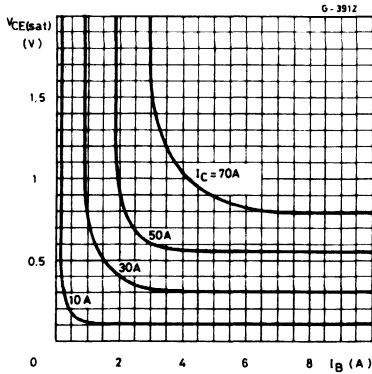

Collector-emitter Saturation Voltage.

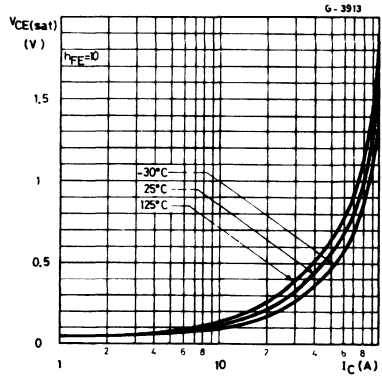

Base-emitter Saturation Voltage.

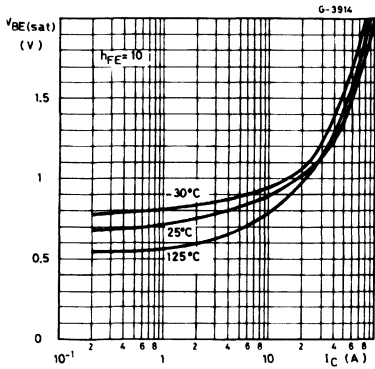

Saturated Switching Characteristics.

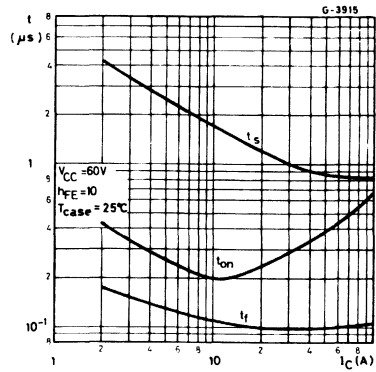

Saturated Switching Characteristics.

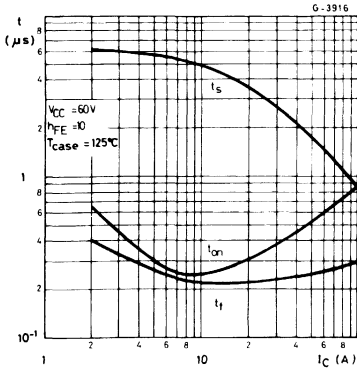

Transition Frequency.

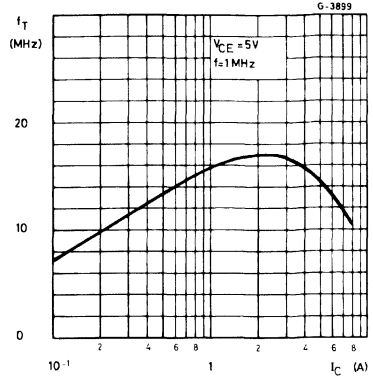

Collector-base Capacitance.

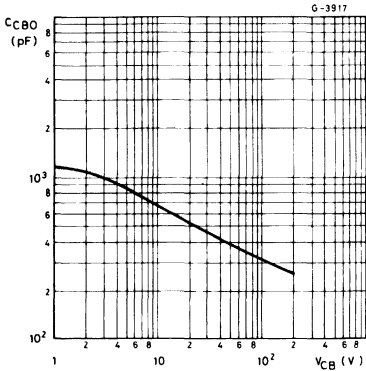

Clamped Reverse Bias Safe Operating Areas.

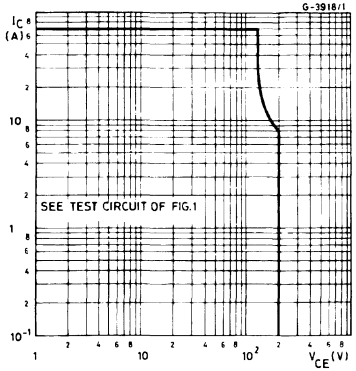
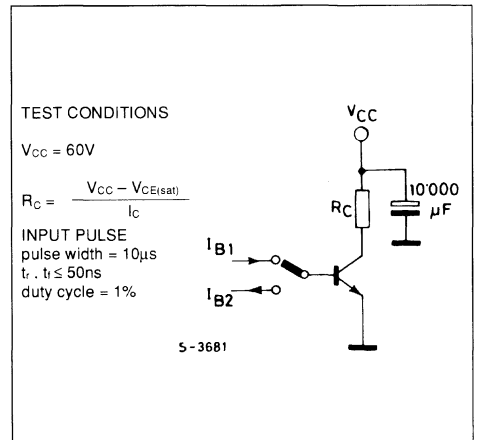
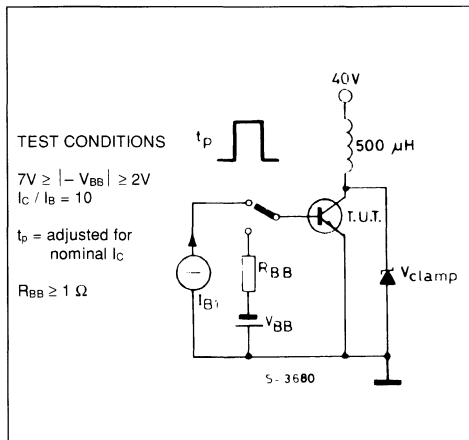

Figure 1 : Clamped $E_{S/b}$ Test Circuit.

Figure 2 : Switching Times Test Circuit (resistive load).



HIGH CURRENT, HIGH SPEED, HIGH POWER TRANSISTOR

DESCRIPTION

The BUR51 is a silicon multiepitaxial planar NPN transistor in modified Jedec TO-3 metal case, intended for use in switching and linear applications in military and industrial equipment.

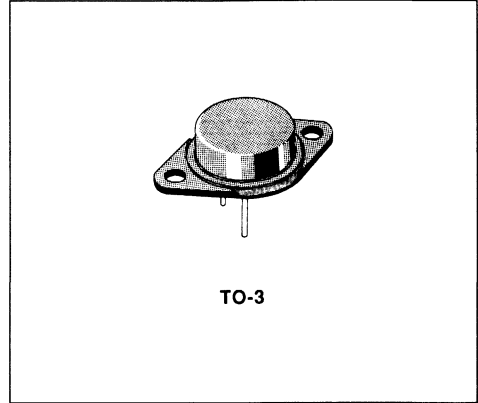

INTERNAL SCHEMATIC DIAGRAM

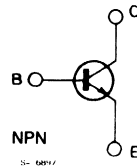

ABSOLUTE MAXIMUM RATINGS

Symbol	Parameter	Value	Unit
V_{CBO}	Collector-base Voltage ($I_E = 0$)	300	V
V_{CEO}	Collector-emitter Voltage ($I_B = 0$)	200	V
V_{EBO}	Emitter-base Voltage ($I_C = 0$)	10	V
I_C	Collector Current	60	A
I_{CM}	Collector Peak Current ($t_p = 10$ ms)	80	A
I_B	Base Current	16	A
P_{tot}	Total Power Dissipation at $T_{case} \leq 25$ °C	350	W
T_{stg}	Storage Temperature	- 65 to 200	°C
T_j	Junction Temperature	200	°C

THERMAL DATA

$R_{th\ j-case}$	Thermal Resistance Junction-case	Max	0.5	°C/W
------------------	----------------------------------	-----	-----	------

ELECTRICAL CHARACTERISTICS ($T_{case} = 25\text{ °C}$ unless otherwise specified)

Symbol	Parameter	Test Conditions		Min.	Typ.	Max.	Unit
I_{CBO}	Collector Cutoff Current ($I_E = 0$)	$V_{CB} = 300\text{ V}$ $V_{CB} = 300\text{ V}$ $T_{case} = 125\text{ °C}$				0.2 2	mA mA
I_{CEO}	Collector Cutoff Current ($I_B = 0$)	$V_{CE} = 200\text{ V}$				1	mA
I_{EBO}	Emitter Cutoff Current ($I_C = 0$)	$V_{EB} = 7\text{ V}$				0.2	μA
$V_{CEO(sus)*}$	Collector-emitter Sustaining Voltage	$I_C = 200\text{ mA}$		200			V
V_{EBO}	Emitter-base Voltage ($I_C = 0$)	$I_E = 10\text{ mA}$		10			V
$V_{CE(sat)*}$	Collector-emitter Saturation Voltage	$I_C = 30\text{ A}$ $I_C = 50\text{ A}$	$I_B = 2\text{ A}$ $I_B = 5\text{ A}$		0.9	1 1.5	V V
$V_{BE(sat)*}$	Base-emitter Saturation Voltage	$I_C = 30\text{ A}$ $I_C = 50\text{ A}$	$I_B = 2\text{ A}$ $I_B = 5\text{ A}$		1.55	1.8 2	V V
h_{FE}^*	DC Current Gain	$I_C = 5\text{ A}$ $I_C = 50\text{ A}$	$V_{CE} = 4\text{ V}$ $V_{CE} = 4\text{ V}$	20 15		100	
$I_{S/b}$	Second Breakdown Collector Current	$V_{CE} = 20\text{ V}$	$t = 1\text{ s}$	17.5			A
f_T	Transition Frequency	$I_C = 1\text{ A}$ $f = 1\text{ MHz}$	$V_{CE} = 5\text{ V}$	10	16		MHz
t_{on}	Turn-on Time (fig. 2)	$I_C = 50\text{ A}$ $V_{CC} = 100\text{ V}$	$I_{B1} = 5\text{ A}$		0.35	1	μs
t_s	Storage Time (fig. 2)	$I_C = 50\text{ A}$ $I_{B2} = -5\text{ A}$	$V_{CC} = 100\text{ V}$		0.9	2	μs
t_f	Fall Time (fig. 2)				0.24	0.6	μs
	Clamped $E_{S/b}$ Collector Current (fig. 1)	$V_{clamp} = 200\text{ V}$	$L = 500\text{ μH}$	50			A

* Pulsed : pulse duration = 300μs, duty cycle ≤ 2%.

Safe Operating Areas.

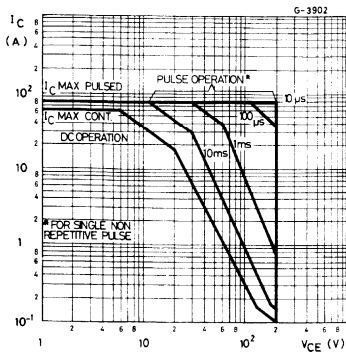

Derating Curves.

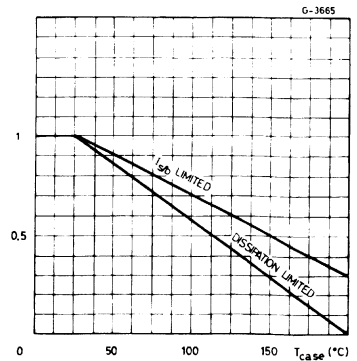

Thermal Transient Response.

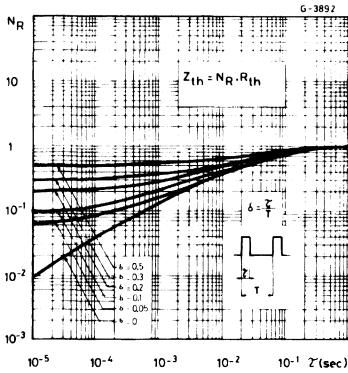

DC Current Gain.

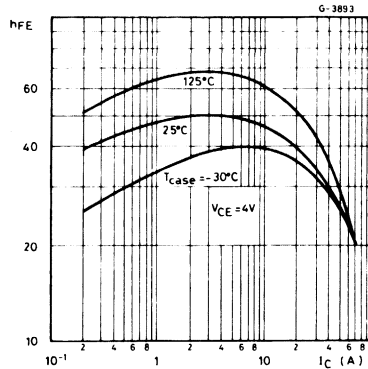

Collector-emitter Saturation Voltage.

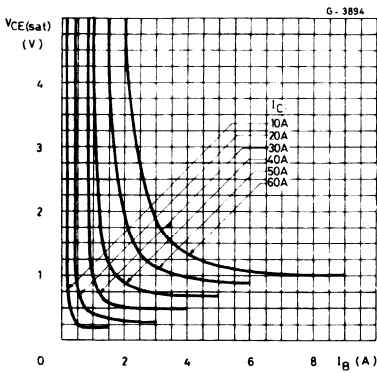

Collector-emitter Saturation Voltage.

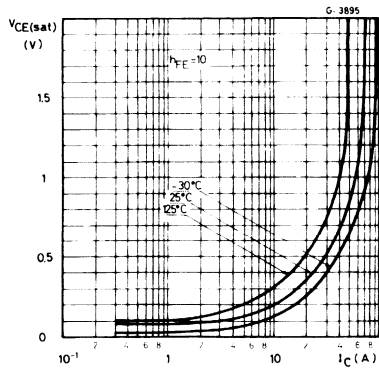

Base-emitter Saturation Voltage.

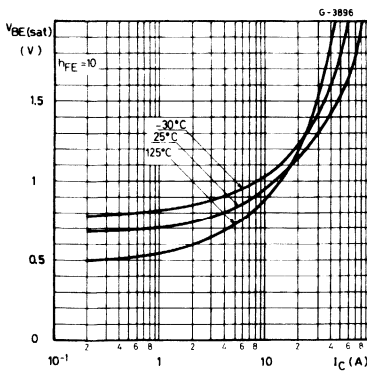

Saturated Switching Characteristics.

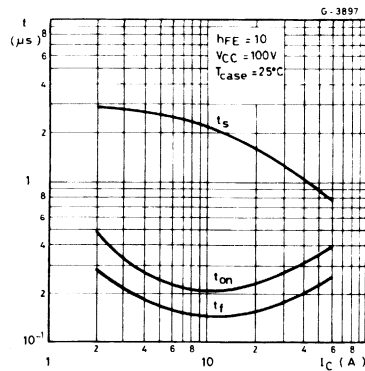

Saturated Switching Characteristics.

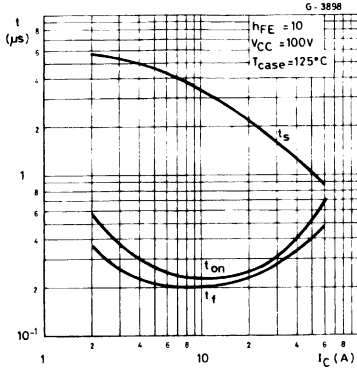

Transition Frequency.

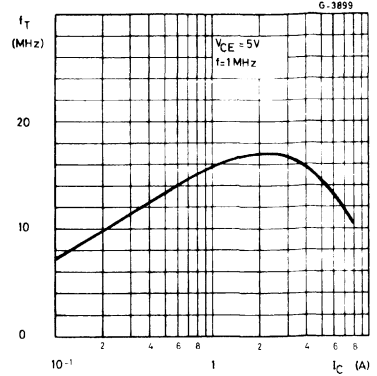

Collector-base Capacitance.

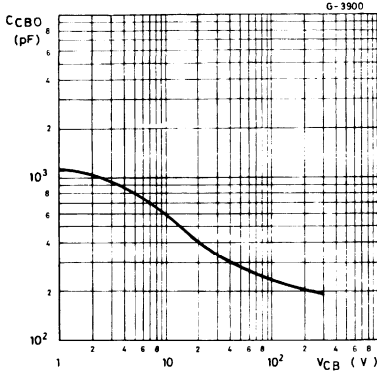

Clamped Reverse Bias Safe Operating Areas.

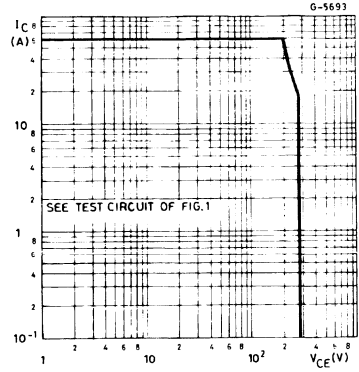
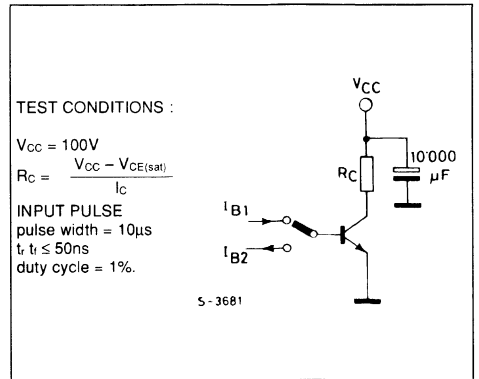
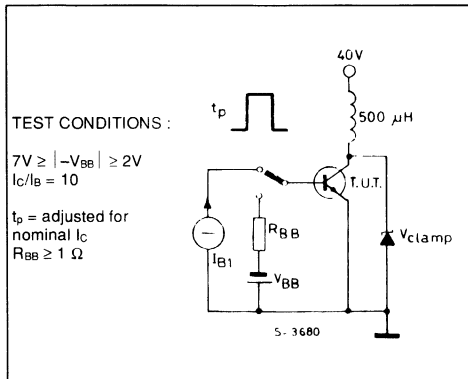

Figure 1 : Clamped Es/b Test Circuit.

Figure 2 : Switching Times Test Circuit (resistive load).



HIGH CURRENT HIGH SPEED, HIGH POWER DARLINGTONS

DESCRIPTION

The BUR52 is a silicon multiepitaxial planar NPN transistor in modified Jedec TO-3 metal case, intended for use in switching and linear applications in military and industrial equipment.

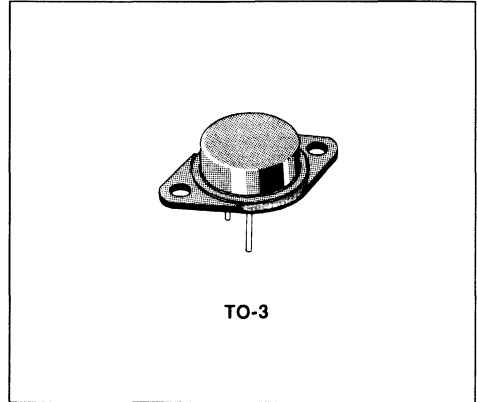
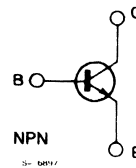
INTERNAL SCHEMATIC DIAGRAM

ABSOLUTE MAXIMUM RATINGS

Symbol	Parameter	Value	Unit
V_{CBO}	Collector-base Voltage ($I_E = 0$)	350	V
V_{CEO}	Collector-emitter Voltage ($I_B = 0$)	250	V
V_{EBO}	Emitter-base Voltage ($I_C = 0$)	10	V
I_C	Collector Current	60	A
I_{CM}	Collector Peak Current ($t_p = 10$ ms)	80	A
I_B	Base Current	16	A
P_{tot}	Total Power Dissipation at $T_{case} \leq 25$ °C	350	W
T_{stg}	Storage Temperature	- 65 to 200	°C
T_j	Junction Temperature	200	°C

THERMAL DATA

$R_{th\ j-case}$	Thermal Resistance Junction-case	Max	0.5	°C/W
------------------	----------------------------------	-----	-----	------

ELECTRICAL CHARACTERISTICS ($T_{case} = 25\text{ °C}$ unless otherwise specified)

Symbol	Parameter	Test Conditions		Min.	Typ.	Max.	Unit
I_{CBO}	Collector Cutoff Current ($I_E = 0$)	$V_{CB} = 350\text{ V}$ $V_{CB} = 350\text{ V}$ $T_{case} = 125\text{ °C}$				0.2 2	mA mA
I_{CEO}	Emitter-cutoff Current ($I_B = 0$)	$V_{CE} = 250\text{ V}$				1	mA
I_{EBO}	Emitter Cutoff Current ($I_C = 0$)	$V_{EB} = 7\text{ V}$				0.2	μA
$V_{CEO(sus)}$ *	Collector-emitter Sustaining Voltage	$I_C = 200\text{ mA}$		250			V
V_{EBO}	Emitter-base Voltage ($I_C = 0$)	$I_E = 10\text{ mA}$		10			V
$V_{CE(sat)}$ *	Collector-emitter Saturation Voltage	$I_C = 25\text{ A}$ $I_C = 40\text{ A}$	$I_B = 2\text{ A}$ $I_B = 4\text{ A}$		0.7	1 1.5	V V
$V_{BE(sat)}$ *	Base-emitter Saturation Voltage	$I_C = 25\text{ A}$ $I_C = 40\text{ A}$	$I_B = 2\text{ A}$ $I_B = 4\text{ A}$		1.5	1.8 2	V V
h_{FE} *	DC Current Gain	$I_C = 5\text{ A}$ $I_C = 40\text{ A}$	$V_{CE} = 4\text{ V}$ $V_{CE} = 4\text{ V}$	20 15		100	
$I_{s/b}$	Second Breakdown Collector Current	$V_{CE} = 20\text{ V}$	$t = 1\text{ s}$	17.5			A
f_T	Transition Frequency	$I_C = 1\text{ A}$ $f = 1\text{ MHz}$	$V_{CE} = 5\text{ V}$		10	16	MHz
t_{on}	Turn-on Time (fig. 2)	$I_C = 40\text{ A}$ $V_{CC} = 100\text{ V}$	$I_{B1} = 4\text{ A}$		0.3	1	μs
t_s	Storage Time (fig. 2)	$I_C = 40\text{ A}$ $I_{B2} = -4\text{ A}$	$V_{CC} = 100\text{ V}$		1.2	2	μs
t_f	Fall Time (fig. 2)				0.20	0.6	μs
	Clamped $E_{s/b}$ Collector Current (fig. 1)	$V_{clamp} = 250\text{ V}$	$L = 500\text{ μH}$	40			A

* Pulsed : pulse duration = 300μs, duty cycle ≤ 2%.

Safe Operating Areas.

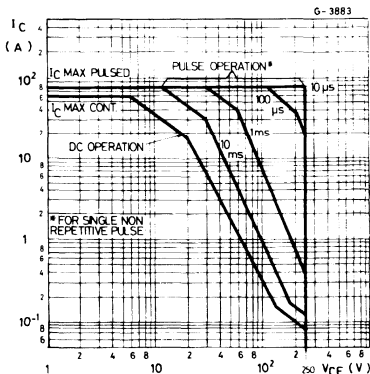

Derating Curves.

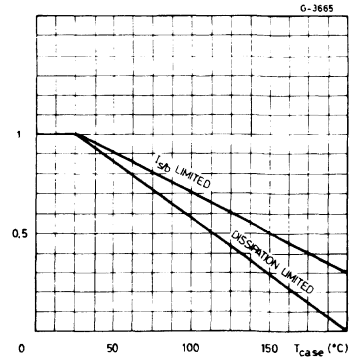

Thermal Transient Response.

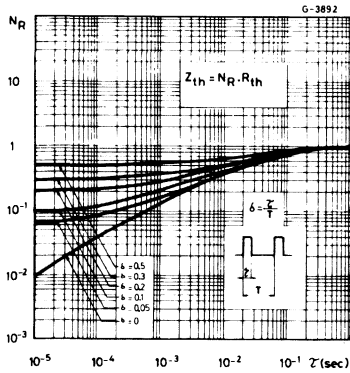

DC Current Gain.

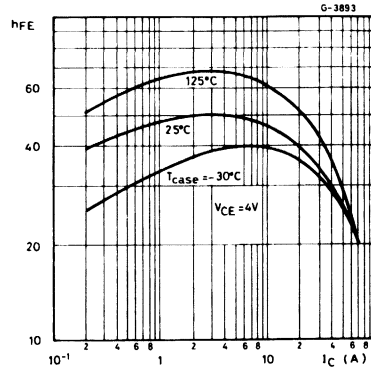

Collector-emitter Saturation Voltage.

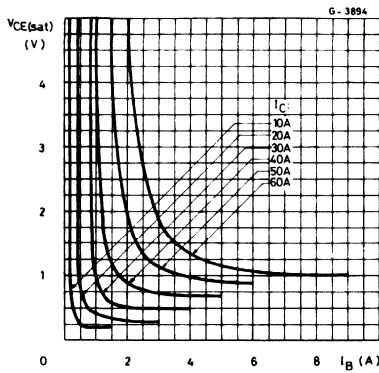

Collector-emitter Saturation Voltage.

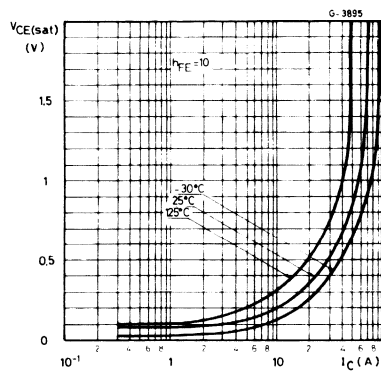

Base-emitter Saturation Voltage.

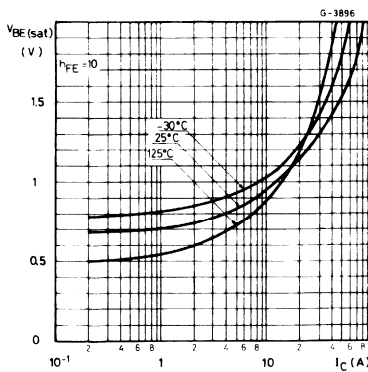

Saturated Switching Characteristics.

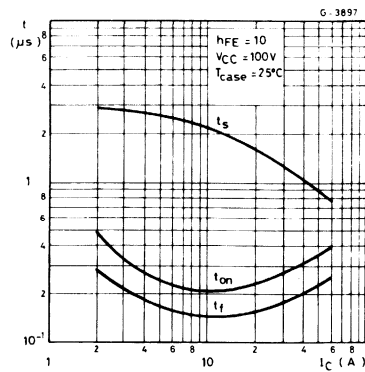

Saturated Switching Characteristics.

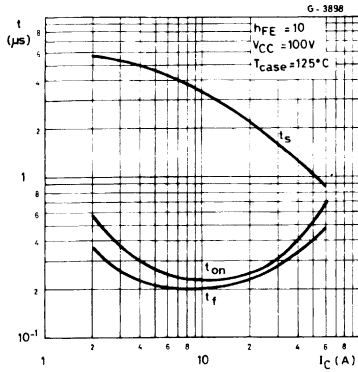

Transition Frequency.

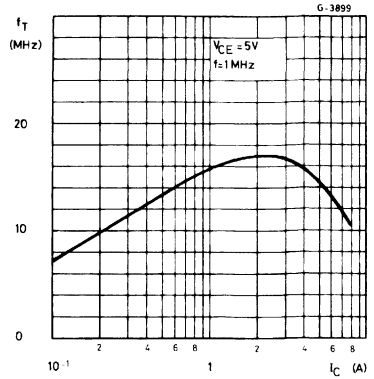

Collector-base Capacitance.

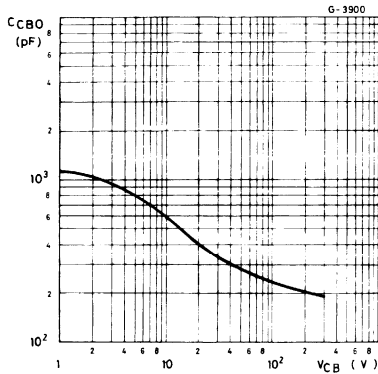

Clamped Reverse Bias Safe Operating Areas.

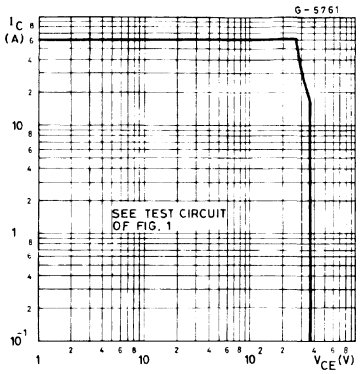
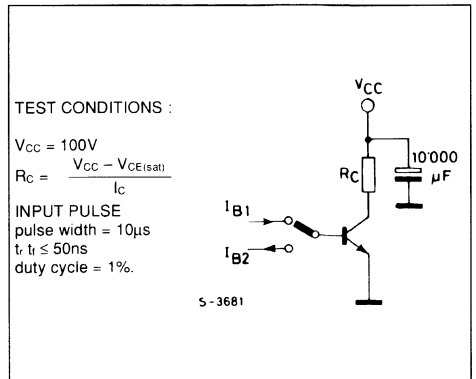
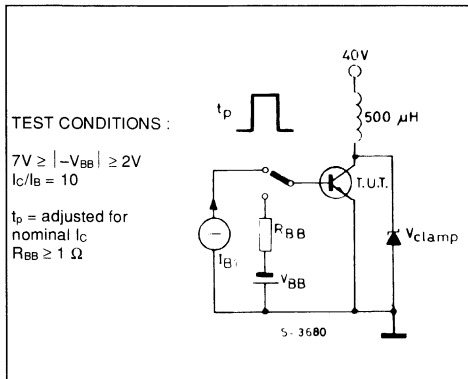

Figure 1 : Clamped Es/b Test Circuit.

Figure 2 : Switching Times Test Circuit (resistive load).



HIGH VOLTAGE SWITCH

DESCRIPTION

The BUT11/A and BUT11FI/AFI are silicon multi-epitaxial mesa NPN transistors respectively in Jedec TO-220 plastic package and ISOWATT220 fully isolated package, particularly intended for switching application.

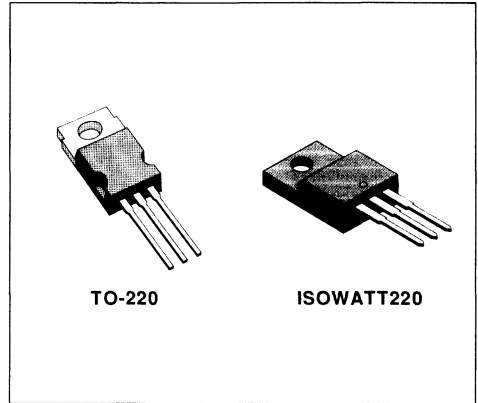

INTERNAL SCHEMATIC DIAGRAM

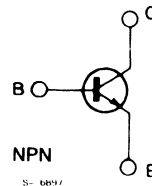

ABSOLUTE MAXIMUM RATINGS

Symbol	Parameter	Value		Unit
		BUT11/FI	BUT11A/AFI	
V_{CES}	Collector-emitter Voltage ($V_{BE} = 0$)	850	1000	V
V_{CEO}	Collector-emitter Voltage ($I_B = 0$)	400	450	V
V_{EBO}	Emitter-base Voltage ($I_C = 0$)	9		V
I_C	Collector Current	5		A
I_{CM}	Collector Peak Current	10		A
I_B	Base Current	2		A
I_{BM}	Base Peak Current	4		A
		TO-220	ISOWATT-220	
P_{tot}	Total Power Dissipation at $T_c \leq 25^\circ\text{C}$	83	35	W
T_{stg}	Storage Temperature	- 65 to 150		$^\circ\text{C}$
T_j	Max. Operating Junction Temperature	150		$^\circ\text{C}$

THERMAL DATA

			TO-220	ISOWATT220	
$R_{th\ j-case}$	Thermal Resistance Junction-case	Max	1.5	3.57	°C/W

ELECTRICAL CHARACTERISTICS ($T_{case} = 25^{\circ}C$ unless otherwise specified)

Symbol	Parameter	Test Conditions		Min.	Typ.	Max.	Unit
I_{CES}	Collector Cutoff Current ($V_{BE} = 0$)	$V_{CE} = \text{rated } V_{CES}$ at $T_{case} = 125^{\circ}C$				1 2	mA mA
I_{EBO}	Emitter Cutoff	$I_C = 0$	$V_{EB} = 9V$			10	mA
V_{CEO}	Collector-emitter Sustaining Voltage	$I_{B(off)} = 0$ for BUT11/FI for BUT11A/AFI	$I_C = 100mA$	400 450			V V
$V_{CE(sat)}$	Collector-emitter Saturation Voltage	$I_C = 3A$ for BUT11/FI $I_C = 2.5A$ for BUT11A/AFI	$I_B = 0.6A$ $I_B = 0.5A$			1.5 1.5	V V
$V_{BE(sat)}$	Base-emitter Saturation Voltage	$I_C = 3A$ for BUT11/FI $I_C = 2.5A$ for BUT11A/AFI	$I_B = 0.6A$ $I_B = 0.5A$			1.3 1.3	V V
t_{on}	Turn on Time	$I_C = 2.5A$	$V_{CC} = 250V$			1	μS
t_s	Storage Time	$I_B = I_{B2} = 0.5A$				4	μS
t_f	Fall Time					0.8	μS

Safe Operating Area.

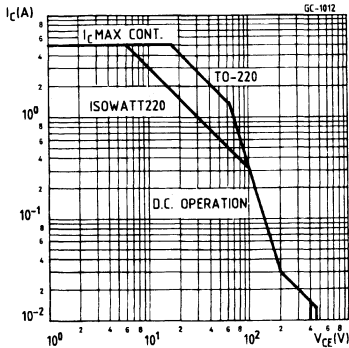

Reverse Biased Safe Operating Area.

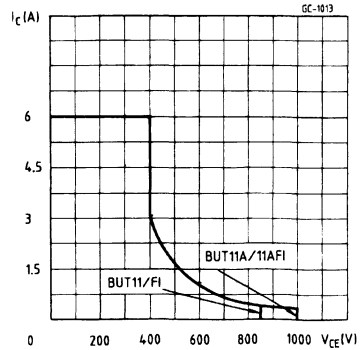

DC Current Gain.

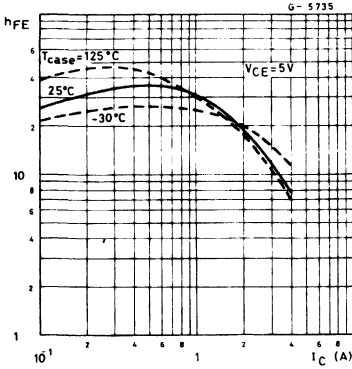

Collector-emitter Saturation Voltage.

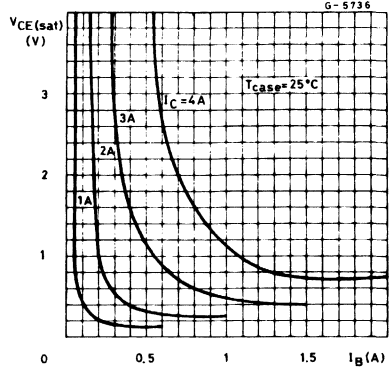

Collector-emitter Saturation Voltage.

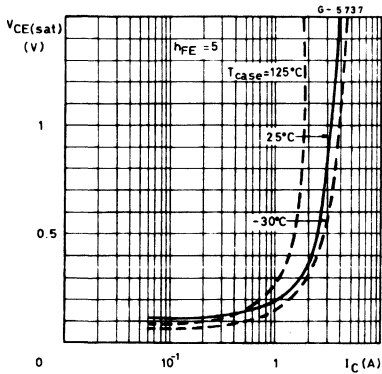

Base-emitter Saturation Voltage.

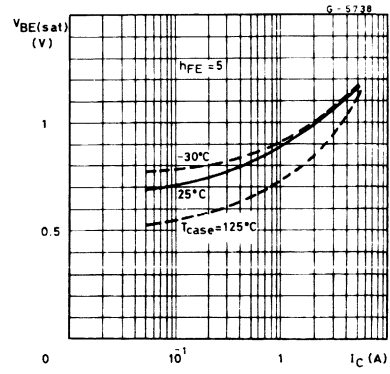

Switching Times Inductive Load (test circuit fig. 2).

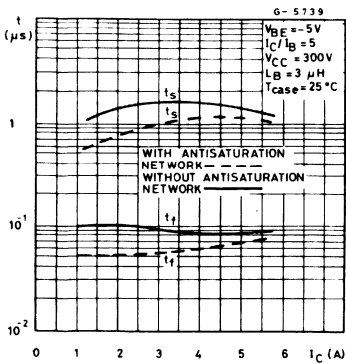

Switching Times Percentage Variation vs. Tcase.

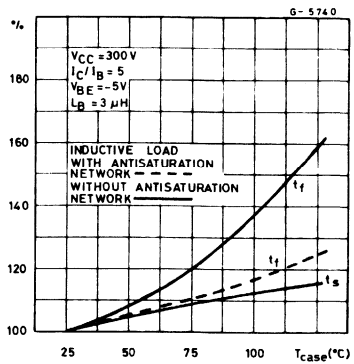

Saturated Switching Characteristics
(test circuit fig. 1).

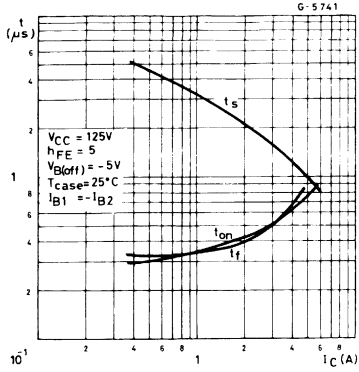

Switching Time Percentage Variation vs. T_{case}
Resistive Load.

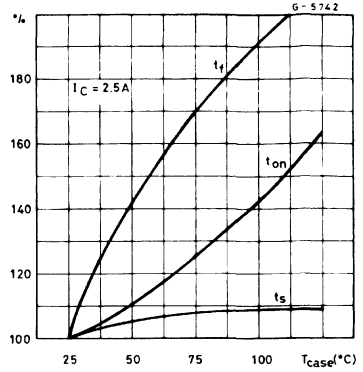

TEST CIRCUITS

Figure 1.

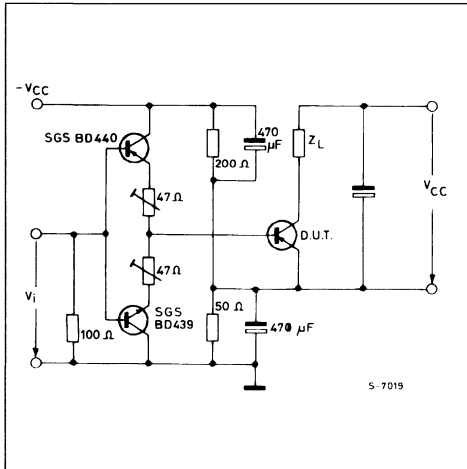
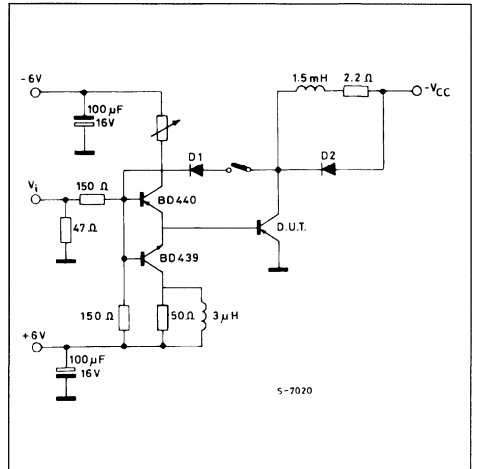

Figure 2.



ISOWATT220 PACKAGE CHARACTERISTICS AND APPLICATION

ISOWATT220 is fully isolated to 2000V dc. Its thermal impedance, given in the data sheet, is optimised to give efficient thermal conduction together with excellent electrical isolation.

The structure of the case ensures optimum distances between the pins and heatsink. The ISOWATT220 package eliminates the need for external isolation so reducing fixing hardware. Accurate moulding techniques used in manufacture assures consistent heat spreader-to-heatsink capacitance.

ISOWATT220 thermal performance is equivalent to that of the standard part, mounted with a 0.1 mm mica washer. The thermally conductive plastic has a higher breakdown rating and is less fragile than mica or plastic sheets. Power derating for ISOWATT220 packages is determined by :

$$P_D = \frac{T_j - T_c}{R_{th}}$$

THERMAL IMPEDANCE OF ISOWATT220 PACKAGE

Fig. 3 illustrates the elements contributing to the thermal resistance of a transistor heatsink assembly, using ISOWATT220 package.

The total thermal resistance $R_{th(tot)}$ is the sum of each of these elements.

The transient thermal impedance, Z_{th} for different pulse durations can be estimated as follows :

- 1 - for a short duration power pulse less than 1ms :
 $Z_{th} < T_{thJ-C}$
- 2 - for an intermediate power pulse of 5ms to 50ms :
 $Z_{th} = T_{thJ-C}$

- 3 - for long power pulses of the order of 500ms or greater :

$$Z_{th} = R_{thJ-C} + R_{thC-HS} + R_{thHS-amb}$$

It is often possible to discern these areas on transient thermal impedance curves.

Figure 3.

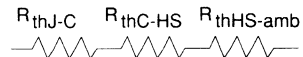

HIGH VOLTAGE POWER SWITCH

- HIGH POWER
- INTEGRATED SPEED-UP DIODE

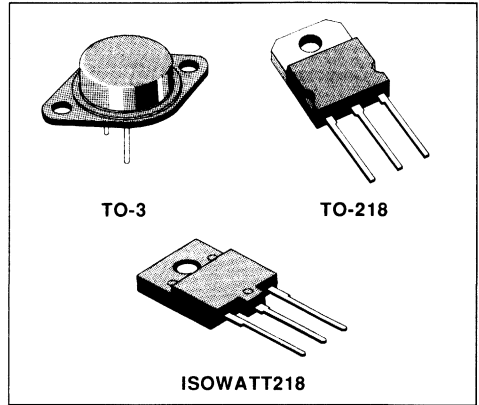

INTERNAL SCHEMATIC DIAGRAM

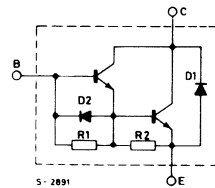

DESCRIPTION

The BUT13, BUT13P and BUT13PFI are silicon multi-epitaxial planar NPN transistors in monolithic darlington configuration with integrated base-emitter speed-up diode, mounted respectively in TO-3 metal case, TO-218 plastic package and ISO-WATT218 fully isolated package.

They are particularly suited for output stages in power, fast switching applications.

ABSOLUTE MAXIMUM RATINGS

Symbol	Parameter	Value			Unit
V_{CBO}	Collector-base Voltage ($I_E = 0$)	600			V
V_{CEO}	Collector-emitter Voltage ($I_B = 0$)	400			V
V_{EBO}	Emitter-base Voltage ($I_C = 0$)	10			V
I_C	Collector Current	28			A
I_{CM}	Collector Peak Current	35			A
I_B	Base Current	6			A
		TO-3	TO-218	ISO-WATT218	
P_{Tot}	Total Dissipation at $T_C < 25^\circ C$	175	125	60	W
T_{stg}	Storage Temperature	- 65 to 200	- 65 to 150	- 65 to 150	$^\circ C$
T_j	Max. Operating Junction Temperature	200	150	150	$^\circ C$

THERMAL DATA

			TO-3	TO-218	ISOWATT218	
$R_{th\ j-case}$	Thermal Resistance Junction-case	Max	1	1	2.08	°C/W

ELECTRICAL CHARACTERISTICS ($T_{case} = 25\ ^\circ\text{C}$ unless otherwise specified)

Symbol	Parameter	Test Conditions	Min.	Typ.	Max.	Unit
I_{CEV}	Collector Cutoff Current	$V_{CE} = 600\ \text{V}$ $V_{CE} = 600\ \text{V}$ $T_{case} = 100\ ^\circ\text{C}$			100 2	μA mA
I_{CEO}	Collector Cutoff Current ($I_B = 0$)	$V_{CE} = 400\ \text{V}$			1	mA
I_{EBO}	Emitter Cutoff Current ($I_C = 0$)	$V_{EB} = 2\ \text{V}$			20	mA
$V_{CEO(sus)*}$	Collector-emitter Sustaining Voltage	$I_C = 100\ \text{mA}$	400			V
$V_{CE(sat)*}$	Collector-emitter Saturation Voltage	$I_C = 10\ \text{A}$ $I_B = 0.5\ \text{A}$ $I_C = 18\ \text{A}$ $I_B = 1.8\ \text{A}$ $I_C = 22\ \text{A}$ $I_B = 2.2\ \text{A}$ $I_C = 28\ \text{A}$ $I_B = 5.6\ \text{A}$		1.3 1.7 2 2.35	2 2.5 3 5	V V V V
$V_{BE(sat)*}$	Base-emitter Saturation Voltage	$I_C = 10\ \text{A}$ $I_B = 0.5\ \text{A}$ $I_C = 18\ \text{A}$ $I_B = 1.8\ \text{A}$ $I_C = 22\ \text{A}$ $I_B = 2.2\ \text{A}$		2.5	2.5 3 3.3	V V V
h_{FE*}	DC Current Gain	$I_C = 10\ \text{A}$ $V_{CE} = 5\ \text{V}$ $I_C = 18\ \text{A}$ $V_{CE} = 5\ \text{V}$	30 30	300 90		
V_F^*	Diode Forward Voltage	$I_F = 22\ \text{A}$		2.2	4	V

RESISTIVE SWITCHING TIMES

Symbol	Parameter	Test Conditions	Min.	Typ.	Max.	Unit
t_{on}	Turn-on Time	$V_{CC} = 250\ \text{V}$ $I_C = 10\ \text{A}$		0.5	0.6	μs
t_s	Storage Time	$I_{B1} = 0.5\ \text{A}$		1.1	1.5	μs
t_f	Fall Time	$V_{BE(off)} = -5\ \text{V}$		0.3	0.6	μs

INDUCTIVE SWITCHING TIMES

Symbol	Parameter	Test Conditions	Min.	Typ.	Max.	Unit
t_s	Storage Time	$V_{clamp} = 250\ \text{V}$ $I_C = 10\ \text{A}$ $I_{B1} = 0.2\ \text{A}$; $V_{BE(off)} = -5\ \text{V}$		1.3	2	μs
t_f	Fall Time			0.11	0.5	μs
t_c	Crossover Time			0.4	0.8	μs
t_s	Storage Time	$V_{clamp} = 250\ \text{V}$ $I_C = 20\ \text{A}$ $I_{B1} = 0.4\ \text{A}$; $V_{BE(off)} = -5\ \text{V}$		1.4	2.6	μs
t_f	Fall Time			0.4	0.7	μs
t_c	Crossover Time			0.8	1.5	μs

* Pulsed : pulse duration = 300 μs , duty cycle = 1.5 %.

Safe Operating Areas (for BUT13).

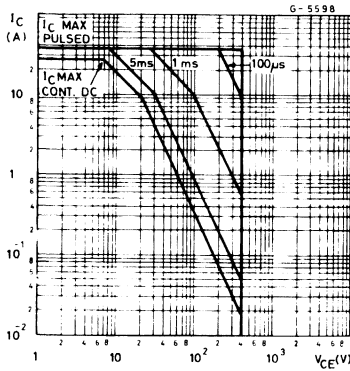

DC Current Gain.

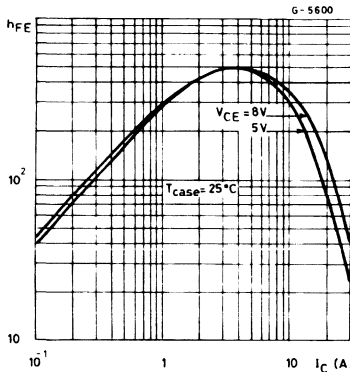

Collector-emitter Saturation Voltage.

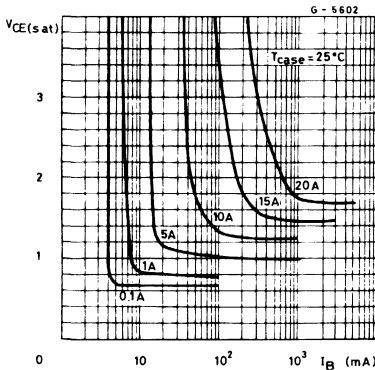

Safe Operating Areas (for BUT13P and BUT13PFI).

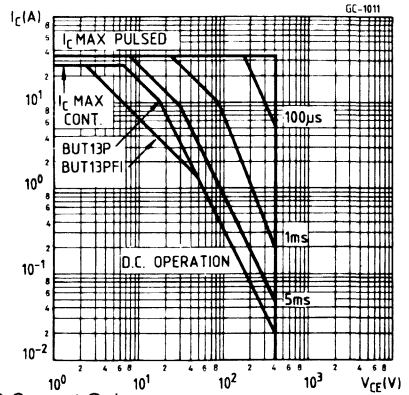

DC Current Gain.

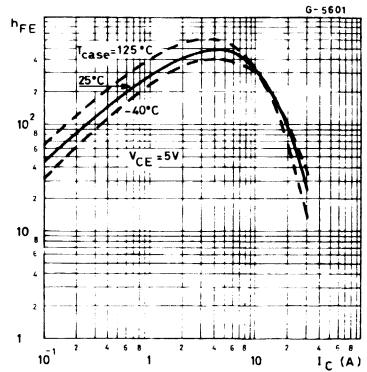

Collector-emitter Saturation Voltage.

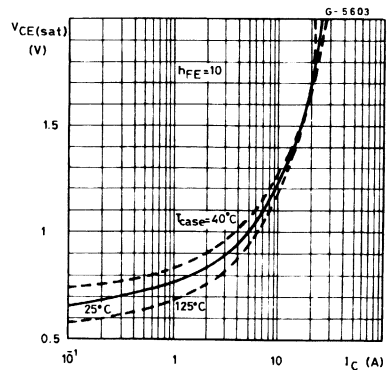

Base-emitter Saturation Voltage.

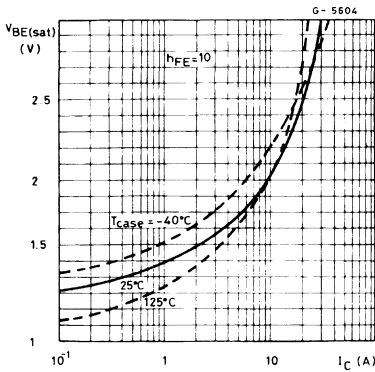

Freewheel Diode Forward Voltage.

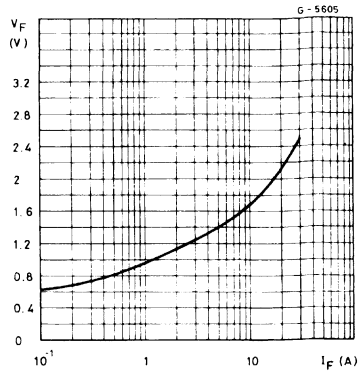

Collector-emitter Saturation Voltage Dynamic.

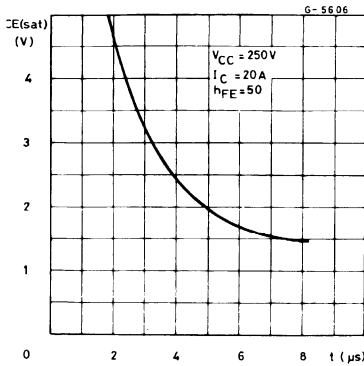

Switching Times Resistive Load (test circuit fig. 1).

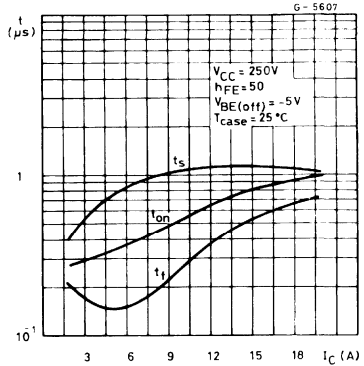

Switching Times Percentage Variation vs. Tcase.

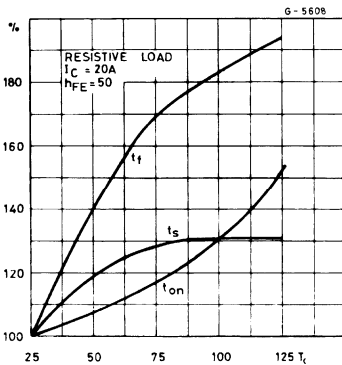

Switching Times Inductive Load Test (test circuit fig. 1).

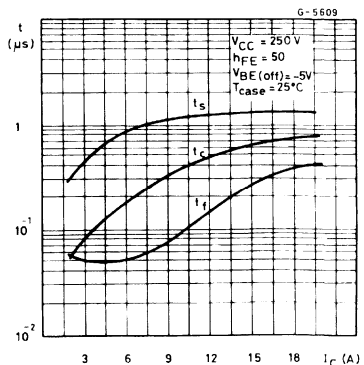

Switching Times Percentage Variation vs. T_{case} .

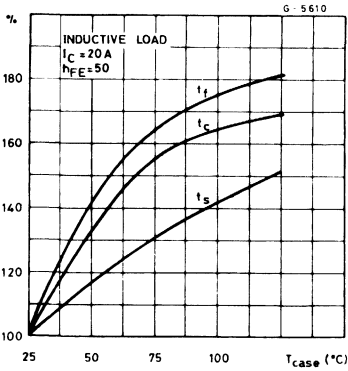

Clamped Reverse Bias Safe Operating Area.

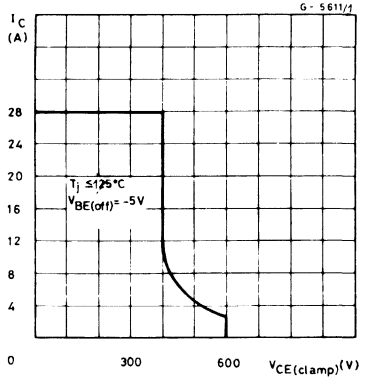

TEST CIRCUITS

Figure 1.

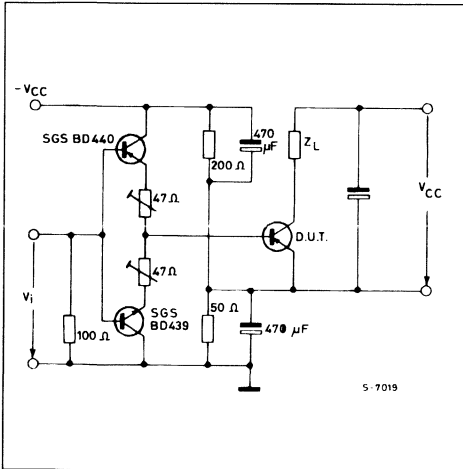

ISOWATT218 PACKAGE CHARACTERISTICS AND APPLICATION

ISOWATT218 is fully isolated to 4000V dc. Its thermal impedance, given in the data sheet, is optimised to give efficient thermal conduction together with excellent electrical isolation.

The structure of the case ensures optimum distances between the pins and heatsink. These distances are in agreement with VDE and UL creepage and clearance standards. The ISOWATT218 package eliminates the need for external isolation so reducing fixing hardware.

The package is supplied with leads longer than the standard TO-218 to allow easy mounting on pcbs.

Accurate moulding techniques used in manufacture assures consistent heat spreader-to-heatsink capacitance.

ISOWATT218 thermal performance is equivalent to that of the standard part, mounted with a 0.1mm mica washer.

The thermally conductive plastic has a higher breakdown rating and is less fragile than mica or plastic sheets. Power derating for ISOWATT218 packages is determined by :

$$P_D = \frac{T_j - T_c}{R_{th}}$$

THERMAL IMPEDANCE OF ISOWATT218 PACKAGE

Figure 2 illustrates the elements contributing to the thermal resistance of a transistor heatsink assembly, using ISOWATT218 package.

The total thermal resistance $R_{th(tot)}$ is the sum of each of these elements.

The transient thermal impedance, Z_{th} for different pulse durations can be estimated as follows :

1-For a short duration power pulse of less than 1 ms :
 $Z_{th} < R_{thJ-C}$

2-For an intermediate power pulse of 5ms to 50ms seconds :

$$Z_{th} = R_{thJ-C}$$

3-For long power pulses of the order of 500ms seconds or greater :

$$Z_{th} = R_{thJ-C} + R_{thC-HS} + R_{thHS-amb}$$

It is often possible to discern these areas on transient thermal impedance curves.

Figure 2.

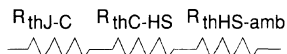

FAST SWITCHING POWER TRANSISTOR

DESCRIPTION

High current, high speed transistor suited for power conversion applications high efficiency converters motors controls.

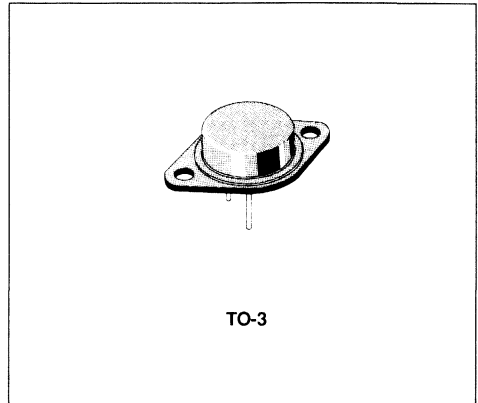

INTERNAL SCHEMATIC DIAGRAM

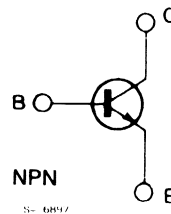

ABSOLUTE MAXIMUM RATINGS

Symbol	Parameter	Value	Unit
V_{CEV}	Collector-emitter Voltage ($V_{BE} = -1.5V$)	200	V
V_{CEO}	Collector-emitter Voltage ($I_B = 0$)	125	V
V_{EBO}	Emitter-base Voltage ($I_C = 0$)	10	V
I_C	Collector Current	50	A
I_{CM}	Collector Peak Current	120	A
I_B	Base Current	12	A
I_{BM}	Base Peak Current	32	A
P_{tot}	Total Dissipation at $T_c < 25^\circ C$	250	W
T_{stg}	Storage Temperature	- 65 to 200	$^\circ C$
T_j	Max. Operating Junction Temperature	200	$^\circ C$

THERMAL DATA

$R_{thj-case}$	Thermal Resistance Junction-case	Max	0.7	°C/W
----------------	----------------------------------	-----	-----	------

ELECTRICAL CHARACTERISTICS($T_{case} = 25^{\circ}C$ unless otherwise specified)

Symbol	Parameter	Test Conditions	Min.	Typ.	Max.	Unit
I_{CER}	Collector Cutoff Current ($R_{BE} = 10\Omega$)	$V_{CE} = V_{CEV}$ $V_{CE} = V_{CEV}$ $T_c = 100^{\circ}C$			0.4 4	mA mA
I_{CEV}	Collector Cutoff Current	$V_{CE} = V_{CEV}$ $V_{BE} = -1.5V$ $V_{CE} = V_{CEV}$ $V_{BE} = -1.5V$ $T_c = 100^{\circ}C$			0.2 2	mA mA
I_{EBO}	Emitter Cutoff Current ($I_C = 0$)	$V_{EB} = 7V$			1	mA
$V_{CEO(sus)}^*$	Collector Emitter Sustaining Voltage	$I_C = 0.2A$ $L = 25mH$	125			V
V_{EBO}	Emitter-base Voltage ($I_C = 0$)	$I_E = 50mA$	10			V
$V_{CE(sat)}^*$	Collector-emitter Saturation Voltage	$I_C = 35A$ $I_B = 1.75A$ $I_C = 70A$ $I_B = 7A$ $I_C = 35A$ $I_B = 1.75A$ $T_j = 100^{\circ}C$ $I_C = 70A$ $I_B = 7A$ $T_j = 100^{\circ}C$		0.55 0.8 0.75 1.2	0.9 0.9 1.2 1.5	V V V V
$V_{BE(sat)}^*$	Base-emitter Saturation Voltage	$I_C = 35A$ $I_B = 1.75A$ $I_C = 70A$ $I_B = 7A$ $I_C = 35A$ $I_B = 1.75A$ $T_j = 100^{\circ}C$ $I_C = 70A$ $I_B = 7A$ $T_j = 100^{\circ}C$		1 1.45 1 1.65	1.3 1.8 1.4 2	V V V V

RESISTIVE LOAD

Symbol	Parameter	Test Conditions	Min.	Typ.	Max.	Unit
t_r	Rise Time	$V_{CC} = 100V$ $I_C = 70A$		0.8	1.2	μs
t_s	Storage Time	$I_{B1} = -I_{B2} = 7A$ $t_p = 30\mu s$		0.9	1.5	μs
t_f	Fall Time			0.2	0.4	μs
t_r	Rise Time	$V_{CC} = 100V$ $I_C = 70A$		1.1	1.6	μs
t_s	Storage Time	$I_{B1} = -I_{B2} = 7A$ $t_p = 30\mu s$		1.2	2	μs
t_f	Fall Time	$T_j = 100^{\circ}C$		0.3	0.6	μs

INDUCTIVE LOAD

Symbol	Parameter	Test Conditions	Min.	Typ.	Max.	Unit
t_s	Storage Time	$V_{CC} = 100V$ $V_{clamp} = 125V$		1.25	2	μs
t_f	Fall Time	$I_C = 70A$ $I_{B1} = -I_{B2} = 7A$ $L_C = 70\mu H$		0.16	0.3	μs
t_s	Storage Time	$V_{CC} = 100V$ $V_{clamp} = 125V$		1.5	2.3	μs
t_f	Fall Time	$I_C = 70A$ $I_{B1} = -I_{B2} = 7A$ $L_C = 70\mu H$ $T_j = 100^{\circ}C$		0.25	0.5	μs

* Pulsed · Pulse duration = 300 μs , duty cycle = 2%.

DC and Pulse Area.

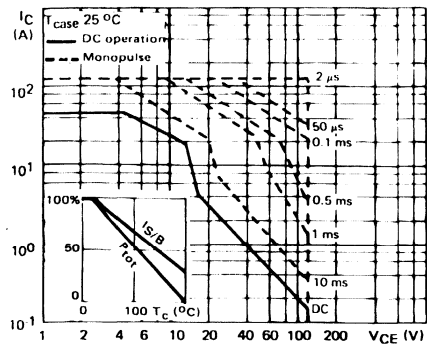

Collector-emitter vs. Base Emitter Resistance.

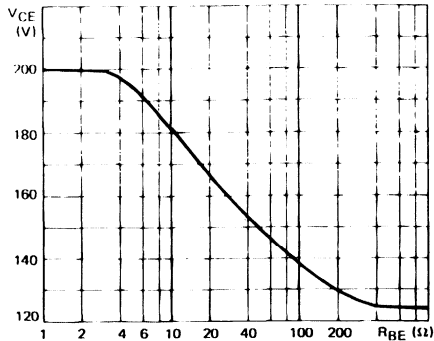

Transient Thermal Response.

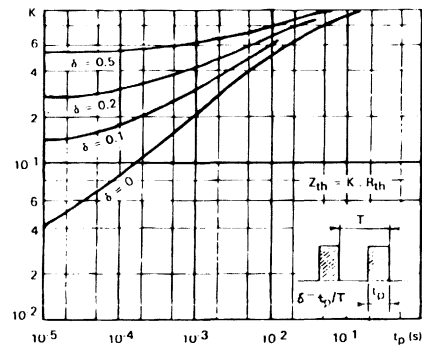

Collector-current Spread vs. Base-emitter Voltage.

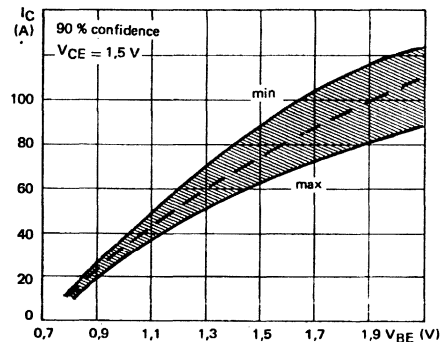

DC Current Gain.

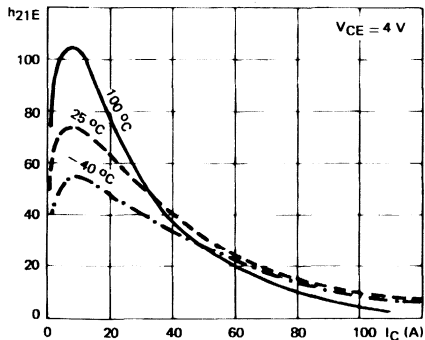

Minimum Base Current to saturate the Transistor.

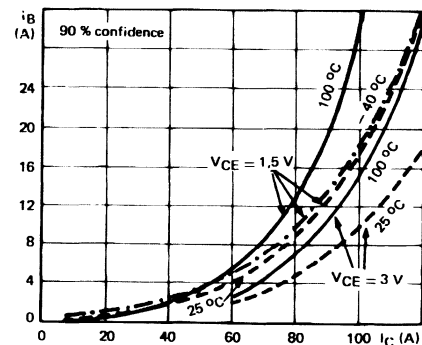

Base Characteristics.

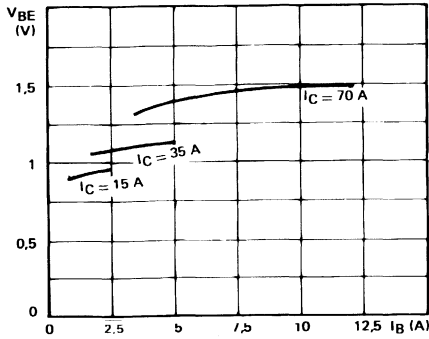

Collector Saturation Region.

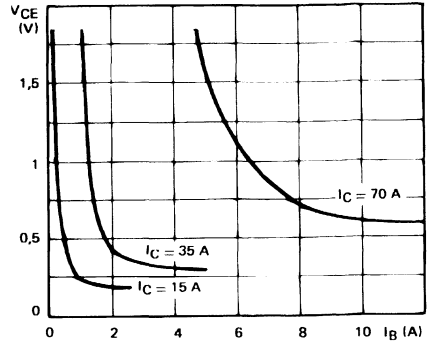

Saturation Voltage Low Gain.

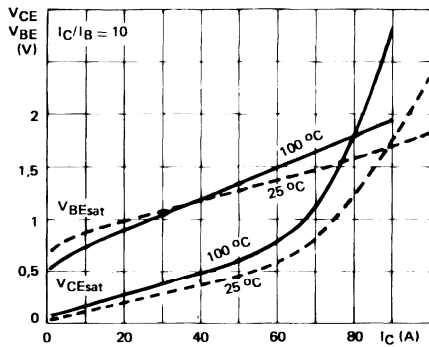

Saturation Voltage High Gain.

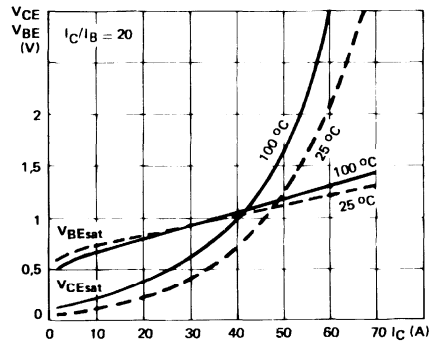

SWITCHING OPERATING AND OVERLOAD AREAS

TRANSISTOR FORWARD BIASED

- During the turn on
- During the turn off without negative base-emitter voltage and $R_{BE} \leq 50\Omega$.

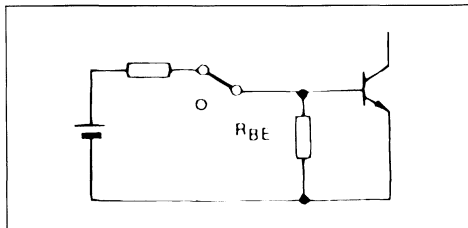

TRANSISTOR REVERSE BIASED

- During the turn off with negative base-emitter voltage.

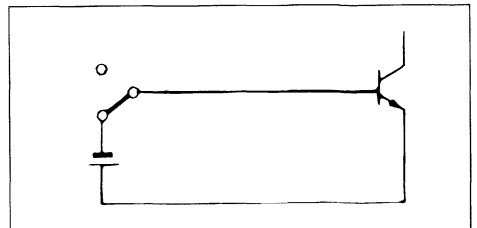

Forward biased Safe Operating Area (FBSOA).

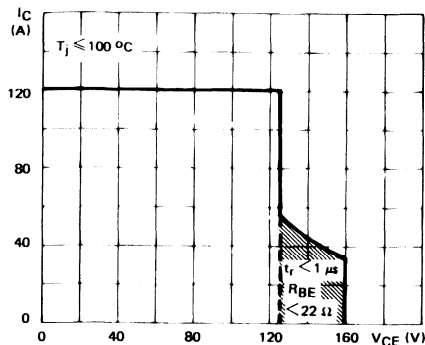

The hatched zone can only be used for turn on.

Forward biased Accidental Overload Area (FBAOA).

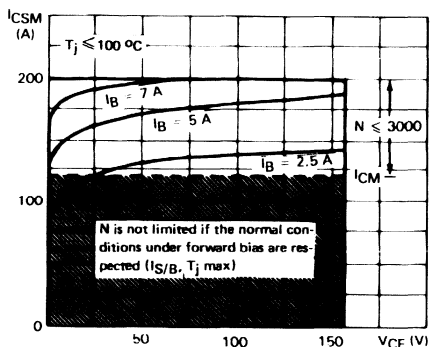

The Kellog network (heavy point) allows the calculation of the maximum value of the short-circuit current for a given base current I_B (90% confidence).

High accidental surge currents ($I > I_{CM}$) are allowed if they are non repetitive and applied less than 3000 times during the component life.

Reverse biased Safe Operating Area (RBSOA).

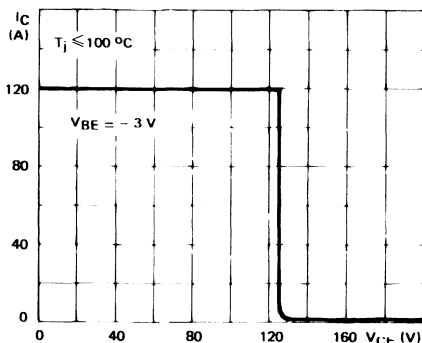

Reverse biased Accidental Overload Area (RBAOA).

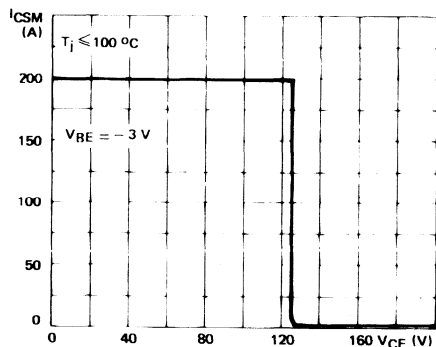

After the accidental overload current, the RBAOA has to be used for the turn off.

Switching Times vs. Collector Current (resistive load).

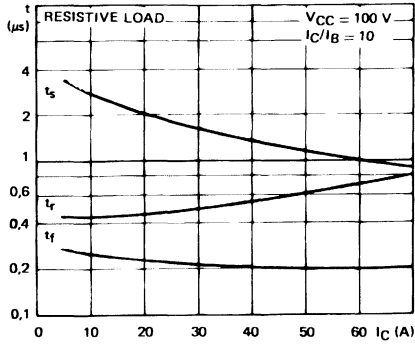

Switching Times vs. Collector Current (inductive load).

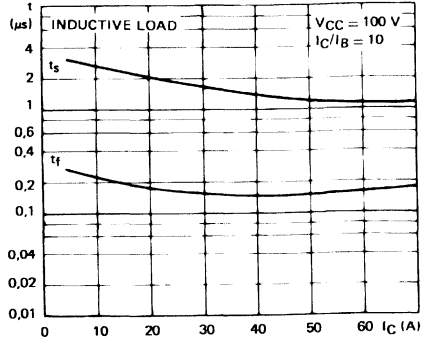

Inductive Load with Negative Base Drive.

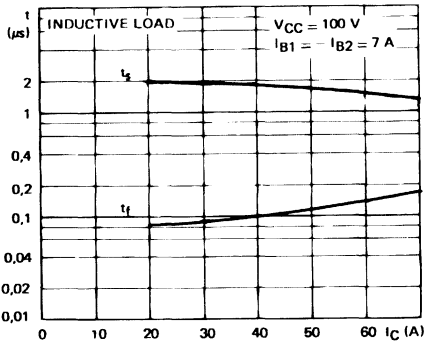

Inductive Load without Negative Base Drive.

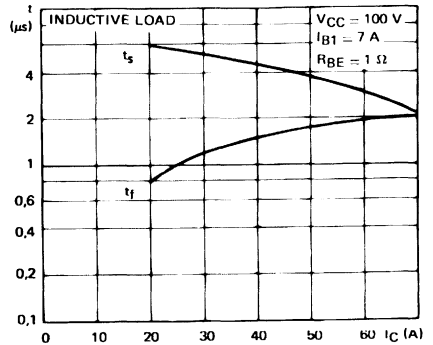

Switching Times vs. Junction Temperature.

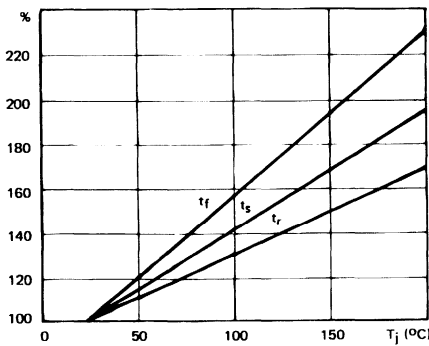

FAST SWITCHING POWER TRANSISTOR

- HIGH CURRENT CAPABILITY
- LOW SATURATION VOLTAGE
- FAST TURN-ON AND TURN-OFF

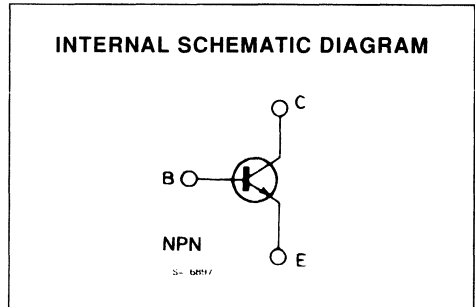
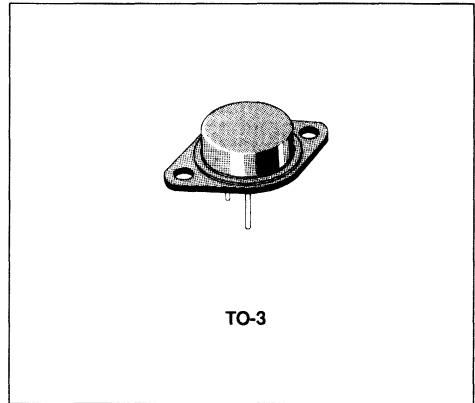
DESCRIPTION

High current, high speed transistor suited for low voltage application.

ABSOLUTE MAXIMUM RATINGS

Symbol	Parameter	Value	Unit
V_{CEV}	Collector-emitter Voltage ($V_{BE} = -1.5V$)	300	V
V_{CEO}	Collector-emitter Voltage ($I_B = 0$)	200	V
V_{EBO}	Emitter-base Voltage ($I_C = 0$)	10	V
I_C	Collector Current	50	A
I_{CM}	Collector Peak Current	70	A
I_B	Base Current	10	A
I_{BM}	Base Peak Current	15	A
P_{tot}	Total Dissipation at $T_C < 25^\circ C$	250	W
T_{stg}	Storage Temperature	- 65 to 200	$^\circ C$
T_j	Max. Operating Junction Temperature	200	$^\circ C$

THERMAL DATA

$R_{th\ j-case}$	Thermal Resistance Junction-case	Max	0.7	°C/W
------------------	----------------------------------	-----	-----	------

ELECTRICAL CHARACTERISTICS ($T_{case} = 25^{\circ}C$ unless otherwise specified)

Symbol	Parameter	Test Conditions	Min.	Typ.	Max.	Unit
I_{CER}	Collector Cutoff Current ($R_{BE} = 10\Omega$)	$V_{CE} = V_{CEV}$ $V_{CE} = V_{CEV}$ $T_C = 100^{\circ}C$			0.4 4	mA mA
I_{CEV}	Collector Cutoff Current	$V_{CE} = V_{CEV}$ $V_{BE} = -1.5V$ $V_{CE} = V_{CEV}$ $V_{BE} = -1.5V$ $T_C = 100^{\circ}C$			0.2 2	mA mA
I_{EBO}	Emitter Cutoff Current ($I_C = 0$)	$V_{EB} = 7V$			1	mA
$V_{CEO(sus)*}$	Collector Emitter Sustaining Voltage	$I_C = 0.2A$ $L = 25mH$	200			V
V_{EBO}	Emitter-base Voltage ($I_C = 0$)	$I_E = 50mA$	10			V
$V_{CE(sat)*}$	Collector-emitter Saturation Voltage	$I_C = 20A$ $I_B = 1A$ $I_C = 40A$ $I_B = 4A$ $I_C = 20A$ $I_B = 1A$ $T_j = 100^{\circ}C$ $I_C = 40A$ $I_B = 4A$ $T_j = 100^{\circ}C$		0.55 0.7 0.7 0.95	0.9 1.2 1.2 1.8	V V V V
$V_{BE(sat)*}$	Base-emitter Saturation Voltage	$I_C = 20A$ $I_B = 1A$ $I_C = 40A$ $I_B = 4A$ $I_C = 20A$ $I_B = 1A$ $T_j = 100^{\circ}C$ $I_C = 40A$ $I_B = 4A$ $T_j = 100^{\circ}C$		0.95 1.25 0.9 1.3	1.3 1.8 1.4 1.9	V V V V
t_r t_s t_f	RESISTIVE LOAD Rise Time Storage Time Fall Time	$V_{CC} = 150V$ $I_C = 40A$ $I_{B1} = -I_{B2} = 4A$ $t_p = 30\mu s$		0.5 0.65 0.15	0.8 1.2 0.3	μs μs μs
t_r t_s t_f	Rise Time Storage Time Fall Time	$V_{CC} = 150V$ $I_C = 40A$ $I_{B1} = -I_{B2} = 4A$ $t_p = 30\mu s$ $T_j = 100^{\circ}C$		0.7 0.85 0.32	1.2 1.5 0.65	μs μs μs
t_s t_f	INDUCTIVE LOAD Fall Time Storage Time	$V_{CC} = 150V$ $V_{clamp} = 200V$ $I_C = 40A$ $I_{B1} = -I_{B2} = 4A$ $L_C = 70\mu H$		0.7 0.08	1.5 0.2	μs μs
t_s t_f	Storage Time Fall Time	$V_{CC} = 150V$ $V_{clamp} = 200V$ $I_C = 40A$ $I_{B1} = -I_{B2} = 4A$ $L_C = 70\mu H$ $T_j = 100^{\circ}C$		1.1 0.18	1.8 0.4	μs μs

* Pulsed : Pulse duration = 300 μs , duty cycle = 2%.

DC and AC Pulse Area.

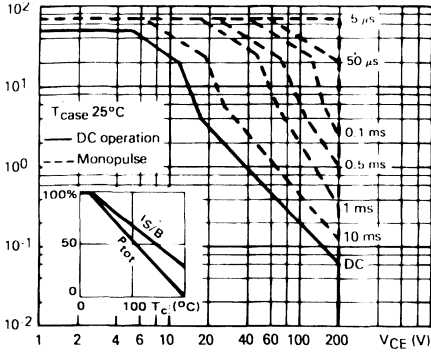

Collector-emitter vs. Base-emitter Resistance.

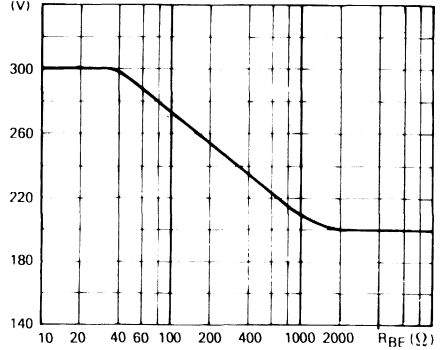

Transient Thermal Response.

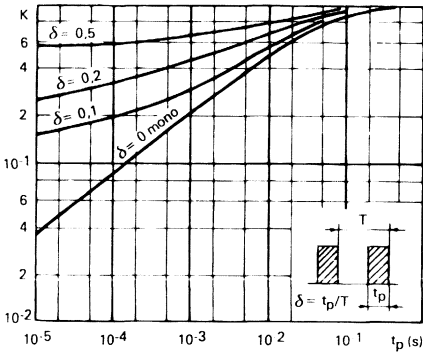

Collector Current Spread vs. Base-emitter Voltage.

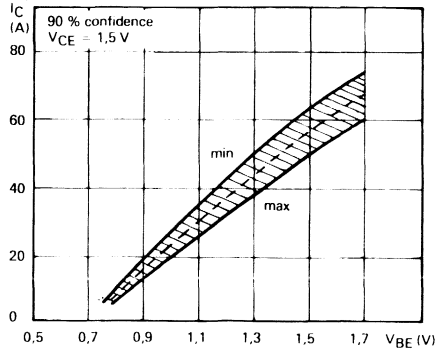

DC Current Gain.

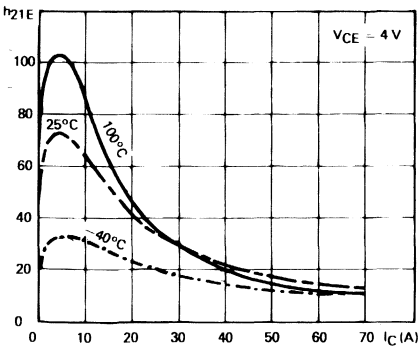

Minimum Base Current to saturate the Transistor.

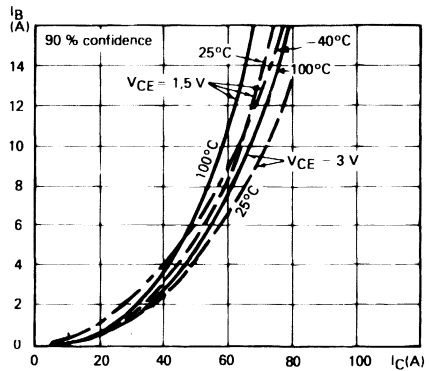

Base Characteristics.

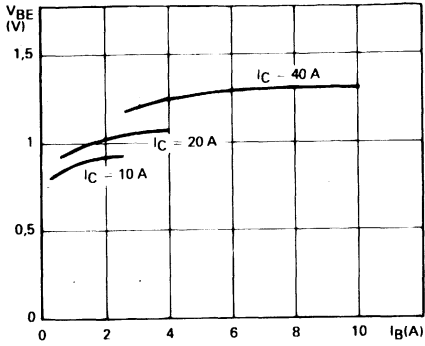

Collector Saturation Region.

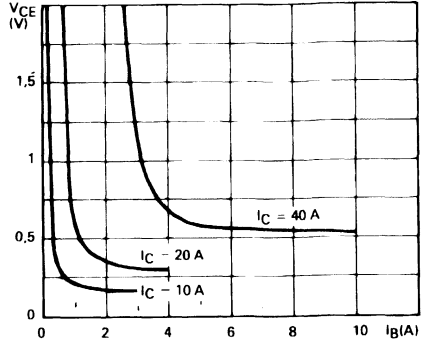

Saturation Voltage Low Gain.

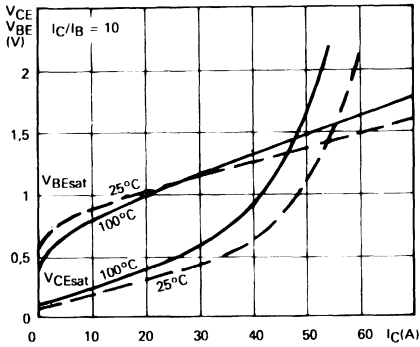

Saturation Voltage High Gain.

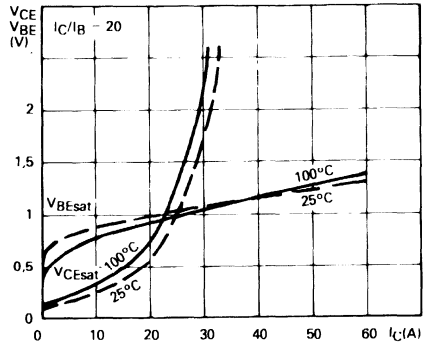

SWITCHING OPERATING AND OVERLOAD AREAS

TRANSISTOR FORWARD BIASED

- During the turn-on
- During the turn-off without negative base emitter voltage and $R_{BE} \leq 50\Omega$.

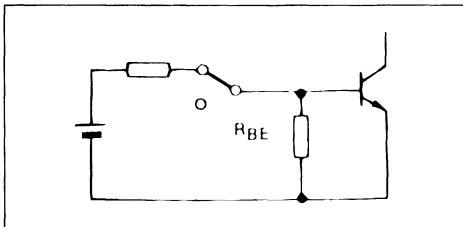

TRANSISTOR REVERSE BIASED

- During the turn-off with negative base-emitter voltage.

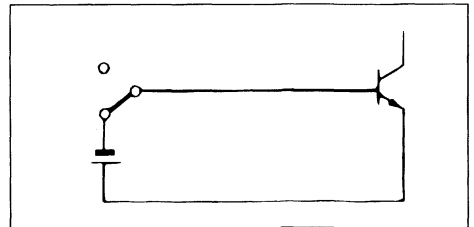

Forward biased Safe Operating Area (FBSOA).

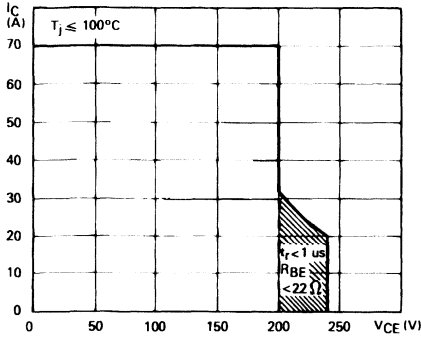

The hatched zone can only be used for turn-on.

Reverse biased Safe Operating Area (RBSOA).

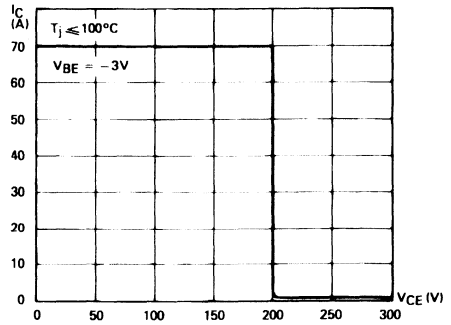

Forward biased Accidental Overload Area (FBAOA).

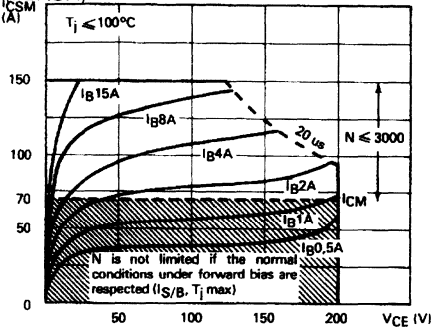

The Kellog network (heavy point) allows the calculation of the maximum value of the short-circuit current for a given base current I_B (90% confidence).

High accidental surge currents ($I > I_{CM}$) are allowed if they are non repetitive and applied less than 3000 times during the component life.

Reverse biased Accidental Overload Area (RBAOA).

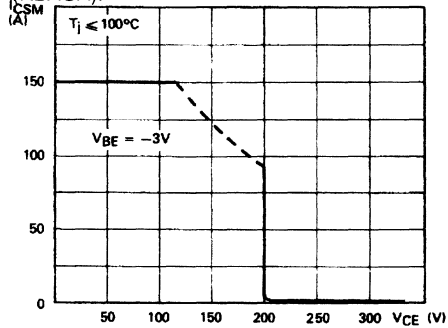

After the accidental overload current, the RBAOA has to be used for the turn-off.

Switching Times vs. Collector Current (resistive load).

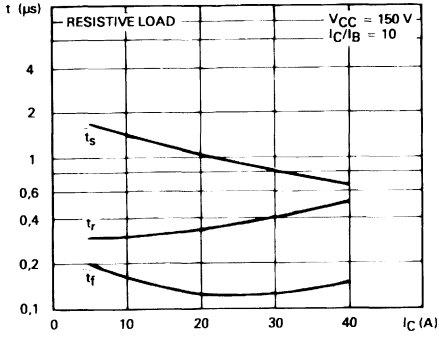

Switching Times vs. Collector Current (inductive load).

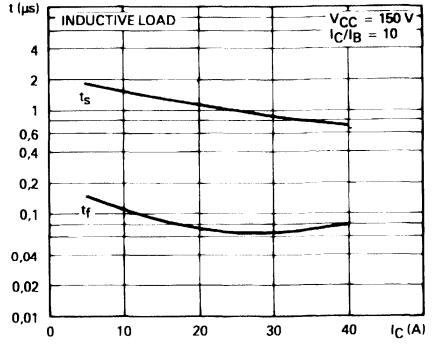

SWITCHING TIMES AT CONSTANT GAIN

Inductive Load with Negative Base Drive.

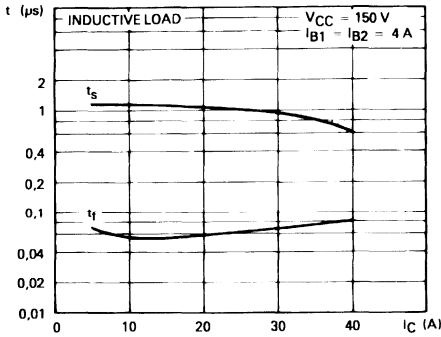

Inductive Load without Negative Base Drive.

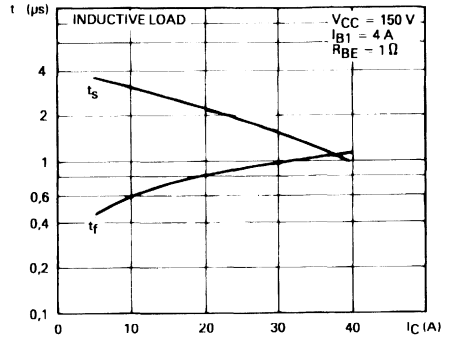

SWITCHING TIMES AT CONSTANT DRIVE

Switching Times vs. Junction Temperature.

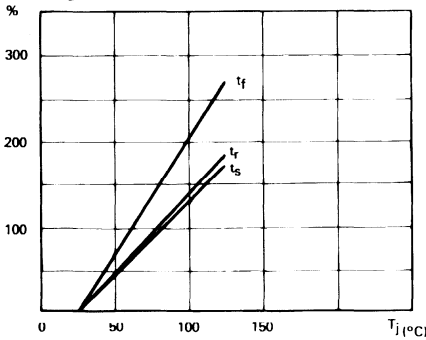

SWITCHING ON RESISTIVE LOAD

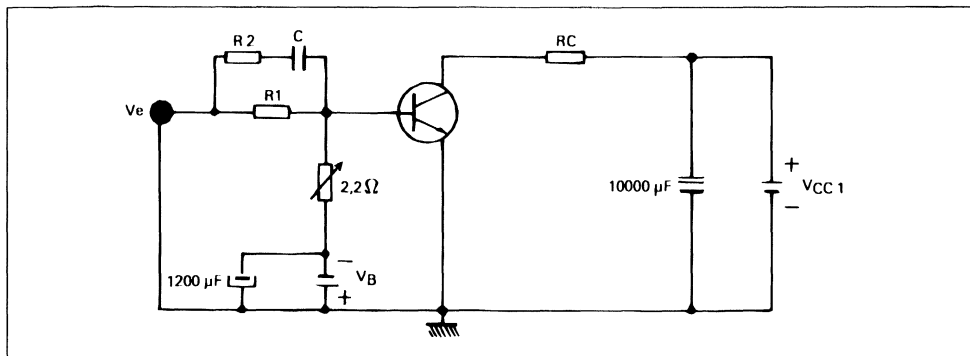

SWITCHING ON INDUCTIVE LOAD

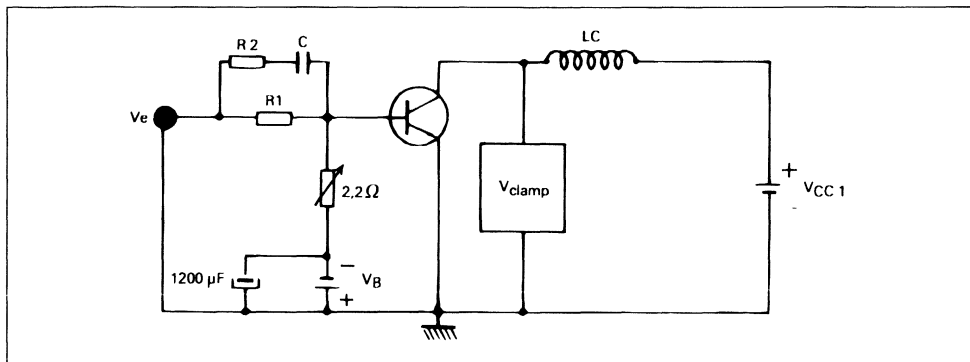

$R_C = 37,5\Omega$
 $R_1 = 2,2\Omega$
 $R_2 = 3,3\Omega$
 $C = 60nF$

Resistance
non
inductive

$I_C = 40A$
 $I_{B1} = -I_{B2} = 4A$
 $V_{CC1} = 150V$
 $V_{CCclamp} = 200V$
 $V_B = 6V$
 $V_e = 25V$
 $L_C = 190\mu H$
 D_1

$$\frac{dI_{B1}}{dt} \geq 10A/\mu s$$

$$\frac{dI_{B2}}{dt} \geq 40A/\mu s$$

Switching on resistive load

$t_p \approx 20\mu s$
 $\delta \leq 1\%$

Switching on inductive load

$t_p \approx 50\mu s$
 $\delta \leq 1\%$

FAST SWITCHING POWER TRANSISTOR

- $h_{FE} > 10$ AT $I_C = 35A$
- HIGH EFFICIENCY SWITCHING
- VERY LOW SATURATION VOLTAGE
- RECTANGULAR SAFE OPERATING AREA
- WIDE ACCIDENTAL OVERLOAD AREA

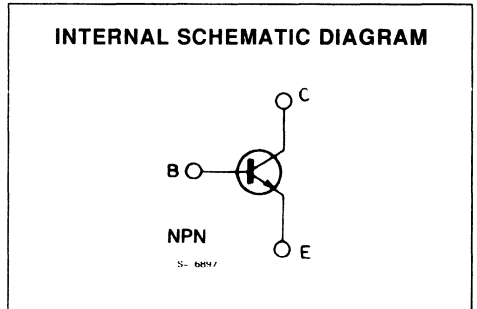
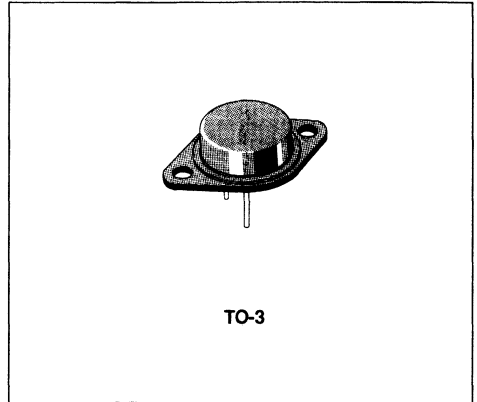

DESCRIPTION

Suitable for motor-drives, S.M.P.S. converters, uninterruptible power supply operating medium low voltage supply.

ABSOLUTE MAXIMUM RATINGS

Symbol	Parameter	Value	Unit
V_{CEV}	Collector-emitter Voltage ($V_{BE} = -1.5V$)	350	V
V_{CEO}	Collector-emitter Voltage ($I_B = 0$)	250	V
V_{EBO}	Emitter-base Voltage ($I_C = 0$)	7	V
I_E	Emitter Current	50	A
I_{EM}	Emitter Peak Current	75	A
I_B	Base Current	10	A
I_{BM}	Base Peak Current	15	A
P_{tot}	Total Dissipation at $T_C < 25^\circ C$	250	W
T_{stg}	Storage Temperature	- 65 to 200	$^\circ C$
T_J	Max. Operating Junction Temperature	200	$^\circ C$

THERMAL DATA

R _{thj-case}	Thermal Resistance Junction-case	max	0.7	°C/W
-----------------------	----------------------------------	-----	-----	------

ELECTRICAL CHARACTERISTICS (T_{case} = 25°C unless otherwise specified)

Symbol	Parameter	Test Conditions	Min.	Typ.	Max.	Unit
I _{CEr}	Collector Cutoff Current (R _{BE} = 10Ω)	V _{CE} = V _{CEV} V _{CE} = V _{CEV} T _c = 100°C			0.4 4	mA mA
I _{CEV}	Collector Cutoff Current	V _{CE} = V _{CEV} V _{BE} = - 1.5V V _{CE} = V _{CEV} V _{BE} = - 1.5V T _c = 100°C			0.2 2	mA mA
I _{EBO}	Emitter Cutoff Current (I _C = 0)	V _{EB} = 7V			1	mA
V _{CEO(sus)} *	Collector Emitter Sustaining Voltage	I _C = 0.2A L = 25mH	250			V
V _{EBO}	Emitter-base Voltage (I _C = 0)	I _E = 50mA	7			V
V _{CE(sat)} *	Collector-emitter Saturation Voltage	I _C = 35A I _B = 3.5A I _C = 35A I _B = 3.5A T _j = 100°C		0.8 1.25	1.2 1.9	V V
V _{BE(sat)} *	Base-emitter Saturation Voltage	I _C = 35A I _B = 3.5A I _C = 35A I _B = 3.5A T _j = 100°C		1.2 1.2	1.5 1.5	V V
di _C /dt	Rated of Rise of on-state Collector Current	V _{CC} = 200V R _C = 0 t _p = 3μs T _j = 100°C See fig. 1 and 2	125	200		A/μs
V _{CE(3μs)}	Collector Emitter Dynamic Voltage	V _{CC} = 200V R _C = 5.7Ω T _j = 100°C See fig. 1 and 2		3	6	V
V _{CE(5μs)}	Collector Emitter Dynamic Voltage	V _{CC} = 200V R _C = 5.7Ω T _j = 100°C See fig. 1 and 2		1.8	3	V
t _s	INDUCTIVE LOAD Storage Time	V _{CC} = 200V V _{clamp} = 250V I _C = 35A I _{B1} = 3.5A		1.4 0.15	3 0.4	μs μs
t _f	Fall Time	V _{BB} = - 5V L _C = 0.28mH		0.3	0.7	μs
t _c	Crossover Time	R _{B2} = 0.7Ω T _j = 100°C See fig. 3a and 3b				
V _{CEW}	Maximum Collector Emitter Voltage without Snubber	V _{CC} = 50V I _{CWoff} = 52A V _{BB} = - 5V I _{B1} = 3.5A L _C = 48μH R _{B2} = 0.7Ω T _j = 125°C See fig. 3a and 3b	250			V

* Pulsed : Pulse duration = 300 μs, duty cycle = 2%.

Figure 1 : Turn-on Switching Test Circuit.

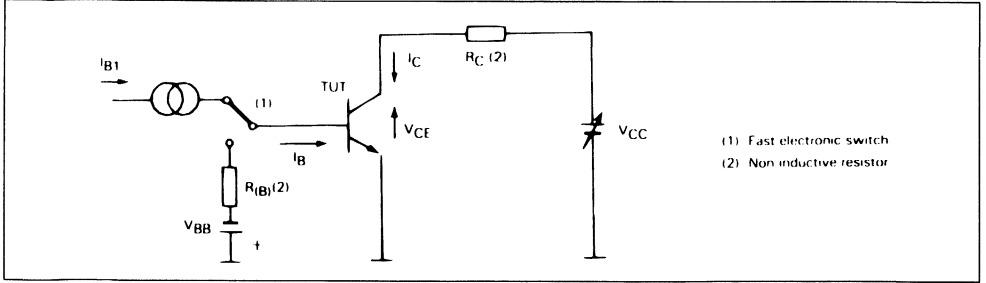

Figure 2 : Turn-off Switching Waveforms.

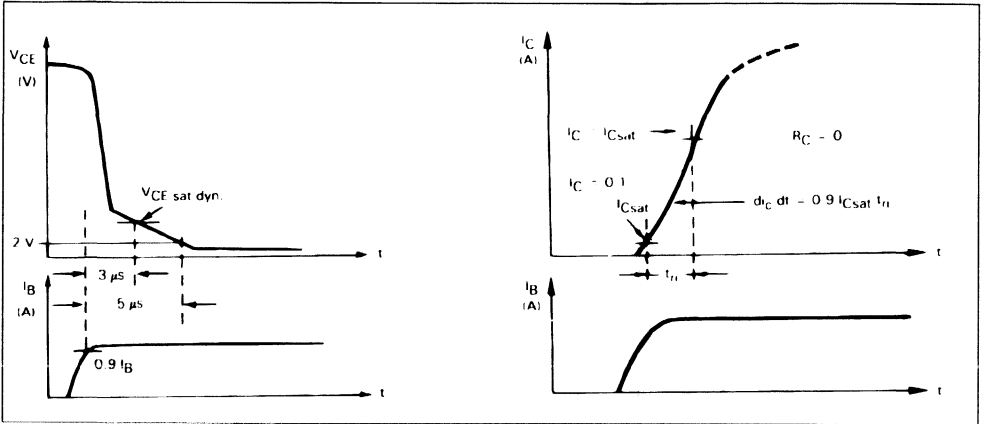

Figure 3a : Turn-off Switching Test Circuit.

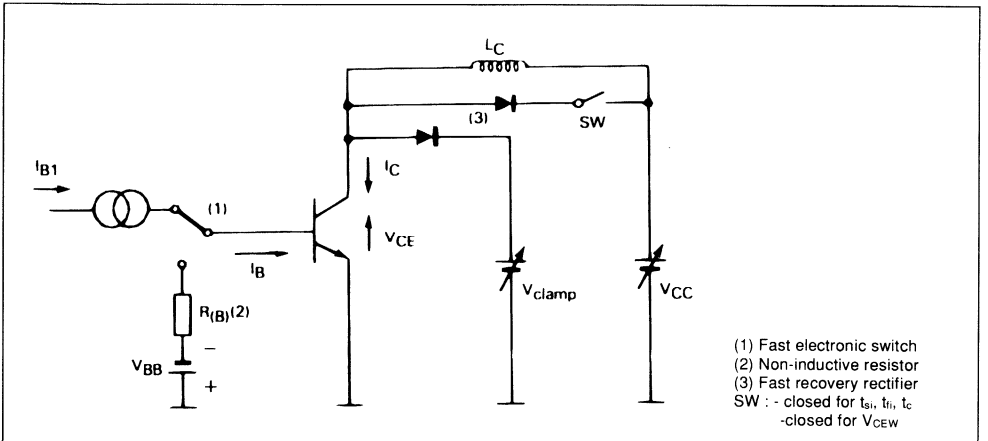
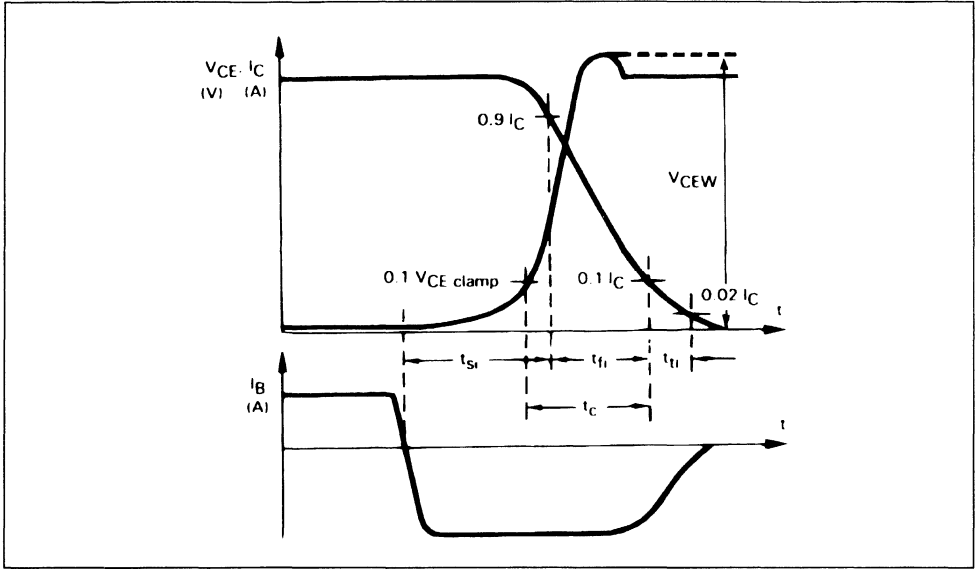
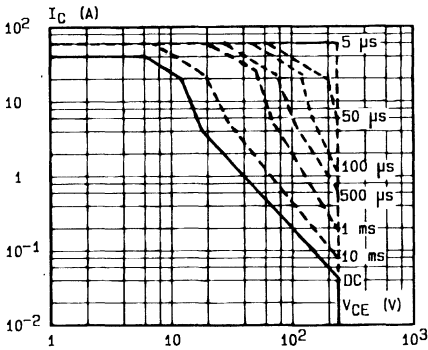

Figure 3b : Turn-off Switching Waveforms (inductive load).



DC and AC Pulse Area.



Collector-emitter Voltage vs. Base emitter Resistance.

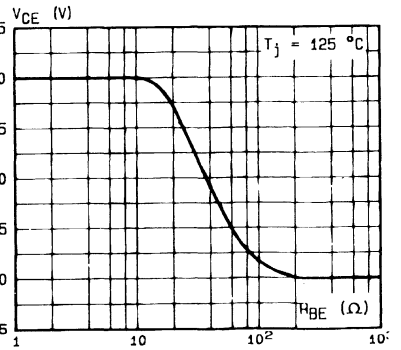

Power and $I_{S/B}$ Derating versus Case Temperature.

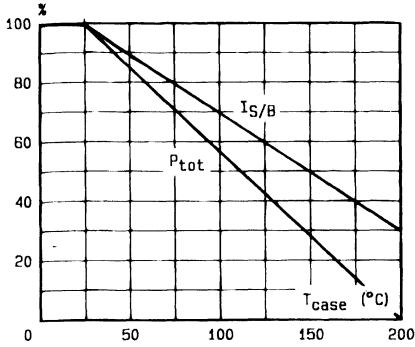

Transient Thermal Response.

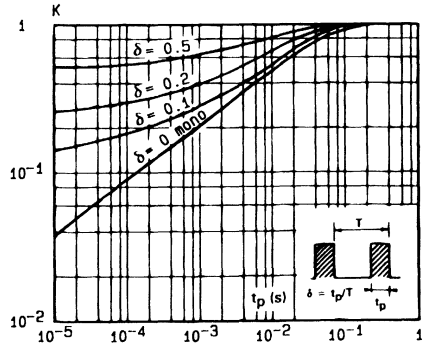

DC Current Gain.

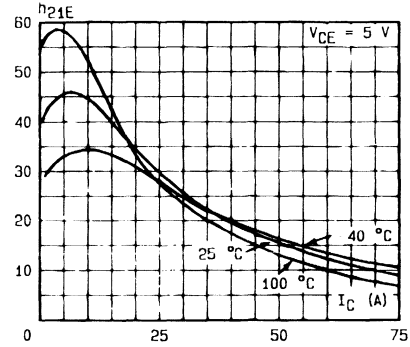

Minimum Base Current to saturate the Transistor.

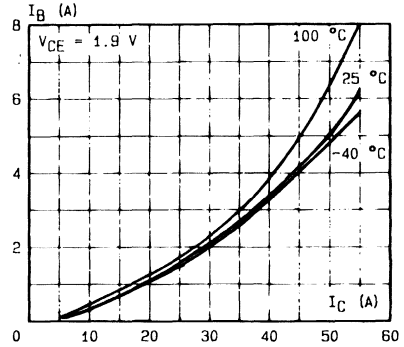

Saturation Voltage.

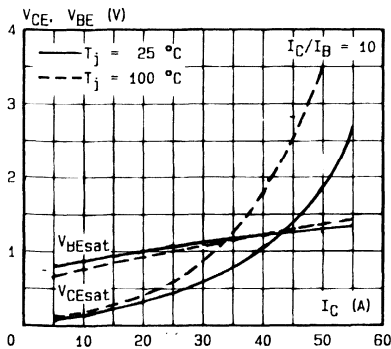

Switching Times versus Collector Current (inductive load).

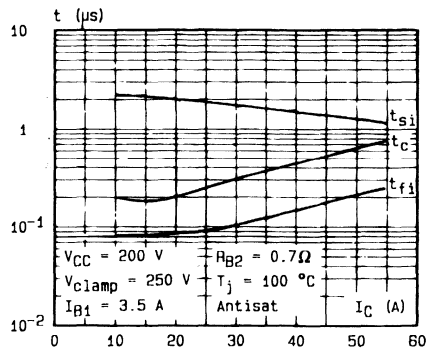

SWITCHING OPERATING AND OVERLOAD AREAS

TRANSISTOR FORWARD BIASED

- During the turn-on
- During the turn-off without negative base-emitter voltage.

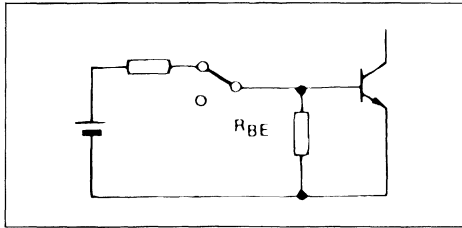

Forward biased Safe Operating Area (FBSOA).

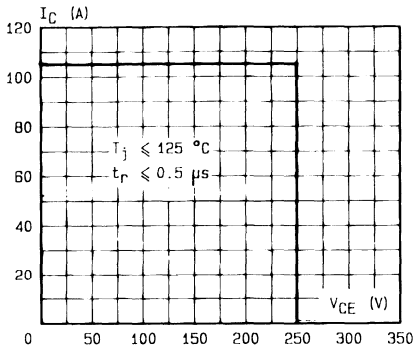

Forward biased Accidental Overload Area (FBAOA).

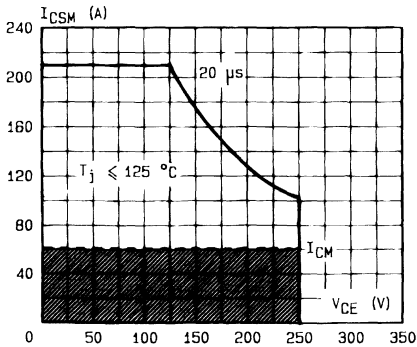

TRANSISTOR REVERSE BIASED

- During the turn-off with negative base-emitter voltage.

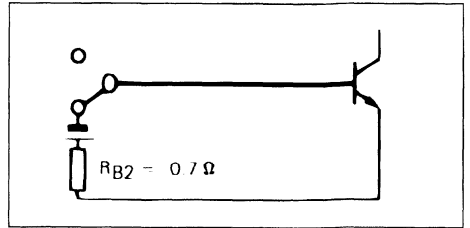

Reverse biased Safe Operating Area (RBSOA).

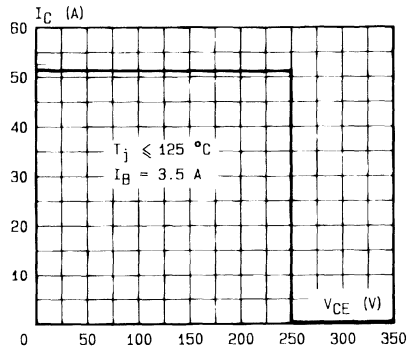

Reverse biased Accidental Overload Area (RBAOA).

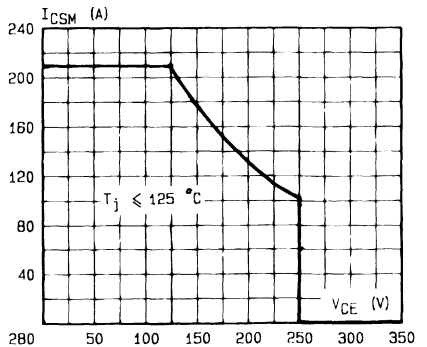

High accidental surge currents ($I > I_{CM}$) are allowed if they are non repetitive and applied less than 3000 times during the component life.

FAST SWITCHING POWER TRANSISTOR

- $h_{FE} > 10$ AT $I_C = 35A$
- HIGH EFFICIENCY SWITCHING
- VERY LOW SATURATION VOLTAGE
- RECTANGULAR SAFE OPERATING AREA
- WIDE ACCIDENTAL OVERLOAD AREA

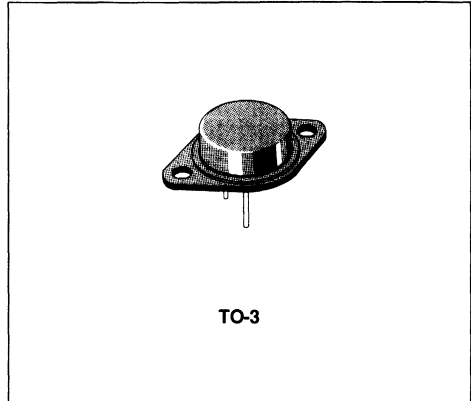
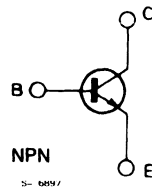
INTERNAL SCHEMATIC DIAGRAM

DESCRIPTION

Suitable for motor-drives, S.M.P.S. converters, uninterruptable power supply operating medium low voltage supply.

ABSOLUTE MAXIMUM RATINGS

Symbol	Parameter	Value	Unit
V_{CEV}	Collector-emitter Voltage ($V_{BE} = -1.5V$)	400	V
V_{CEO}	Collector-emitter Voltage ($I_B = 0$)	300	V
V_{EBO}	Emitter-base Voltage ($I_C = 0$)	7	V
I_E	Emitter Current	50	A
I_{EM}	Emitter Peak Current	75	A
I_B	Base Current	10	A
I_{BM}	Base Peak Current	15	A
P_{tot}	Total Dissipation at $T_c < 25^\circ C$	250	W
T_{stg}	Storage Temperature	- 65 to 200	$^\circ C$
T_j	Max. Operating Junction Temperature	200	$^\circ C$

THERMAL DATA

$R_{thj-case}$	Thermal Resistance Junction-case	Max	0.7	°C/W
----------------	----------------------------------	-----	-----	------

ELECTRICAL CHARACTERISTICS ($T_{case} = 25^{\circ}C$ unless otherwise specified)

Symbol	Parameter	Test Conditions	Min.	Typ.	Max.	Unit
I_{CER}	Collector Cutoff Current ($R_{BE} = 10\Omega$)	$V_{CE} = V_{CEV}$			1	mA
		$V_{CE} = V_{CEV}$ $T_c = 100^{\circ}C$			5	mA
I_{CEV}	Collector Cutoff Current	$V_{CE} = V_{CEV}$ $V_{BE} = -1.5V$			1	mA
		$V_{CE} = V_{CEV}$ $V_{BE} = -1.5V$ $T_c = 100^{\circ}C$			4	mA
I_{EBO}	Emitter Cutoff Current ($I_C = 0$)	$V_{EB} = 5V$			1	mA
$V_{CEO(sus)}^*$	Collector Emitter Sustaining Voltage	$I_C = 0.2A$ $L = 25mH$	300			V
V_{EBO}	Emitter-base Voltage ($I_C = 0$)	$I_E = 50mA$	7			V
$V_{CE(sat)}^*$	Collector-emitter Saturation Voltage	$I_C = 30A$ $I_B = 3A$		0.5	0.9	V
		$I_C = 30A$ $I_B = 3A$ $T_j = 100^{\circ}C$		0.8	1.9	V
$V_{BE(sat)}^*$	Base-emitter Saturation Voltage	$I_C = 30A$ $I_B = 3A$		1.1	1.3	V
		$I_C = 30A$ $I_B = 3A$ $T_j = 100^{\circ}C$		1.05	1.3	V
di_C/dt	Rated of Rise of on-state Collector Current	$V_{CC} = 250V$ $R_C = 0$ $I_{B1} = 4.5A$ $t_p = 3\mu s$ $T_j = 100^{\circ}C$ See fig. 1 and 2	125	190		A/ μs
$V_{CE(3\mu s)}$	Collector Emitter Dynamic Voltage	$V_{CC} = 250V$ $I_{B1} = 4.5A$ $T_j = 100^{\circ}C$ $R_C = 8.3\Omega$ See fig. 1 and 2		3	6	V
$V_{CE(5\mu s)}$	Collector Emitter Dynamic Voltage	$V_{CC} = 250V$ $I_{B1} = 4.5A$ $T_j = 100^{\circ}C$ $R_C = 8.3\Omega$ See fig. 1 and 2		1.5	3	V
t_s t_f t_c	INDUCTIVE LOAD Storage Time	$V_{CC} = 250V$ $V_{clamp} = 300V$ $I_C = 30A$ $I_{B1} = 3A$		1.7	3	μs
	Fall Time	$V_{BB} = -5V$ $L_C = 0.4mH$		0.11	0.4	μs
	Crossover Time	$R_{B2} = 0.83\Omega$ $T_j = 100^{\circ}C$ See fig. 3a and 3b		0.35	0.7	μs
V_{CEW}	Maximum Collector Emitter Voltage without Snubber	$V_{CC} = 50V$ $I_{CWOFF} = 45A$ $V_{BB} = -5V$ $I_{B1} = 3A$ $L_C = 55\mu H$ $R_{BB} = 0.83\Omega$ $T_j = 125^{\circ}C$ See fig. 3a and 3b	300			V

* Pulsed : Pulse duration = 300 μs , duty cycle = 2%.

Figure 1 : Turn-on Switching Test Circuit.

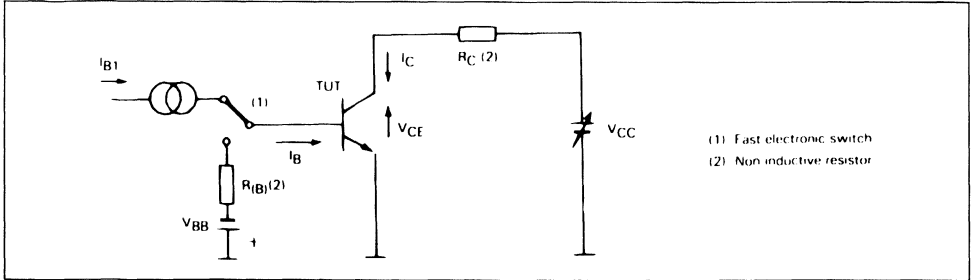

Figure 2 : Turn-off Switching Waveforms.

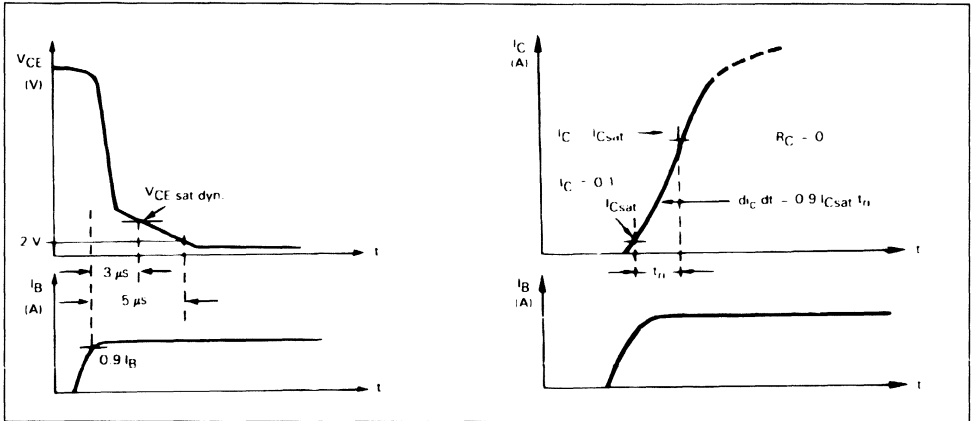

Figure 3a : Turn-off Switching Test Circuit.

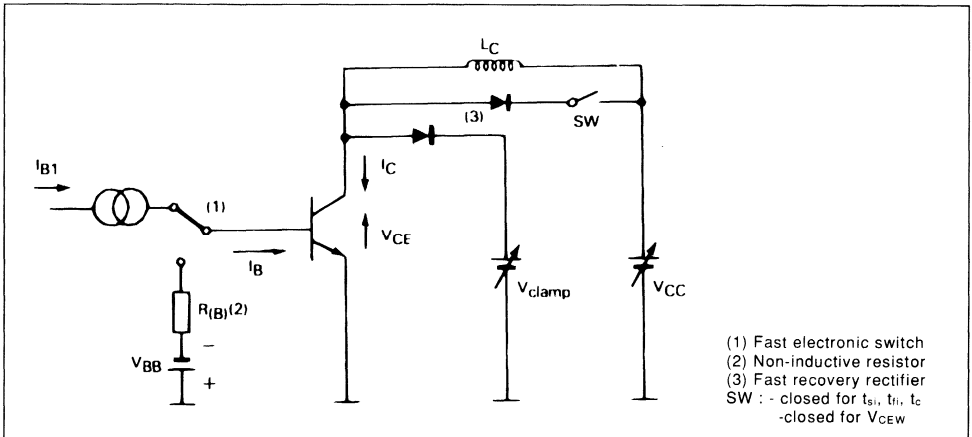
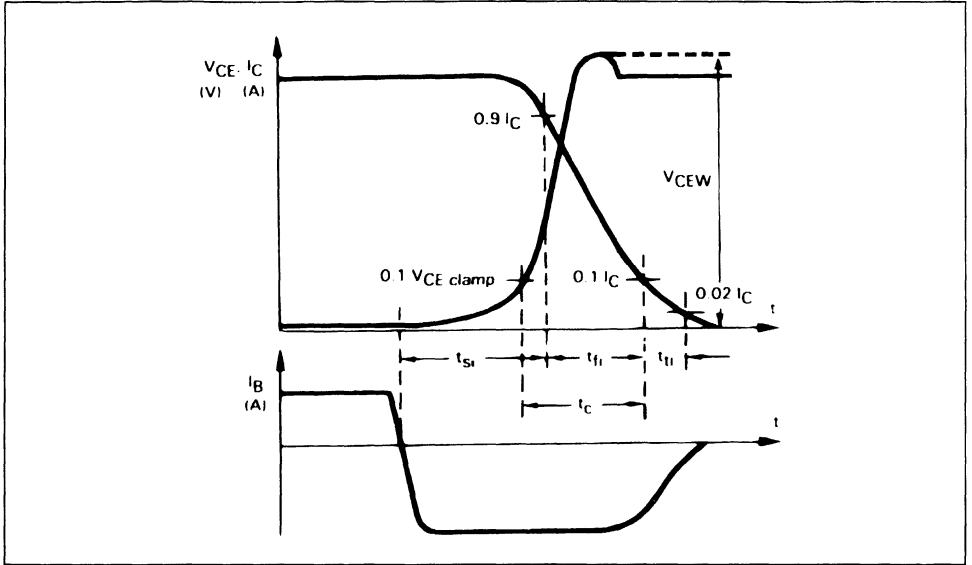
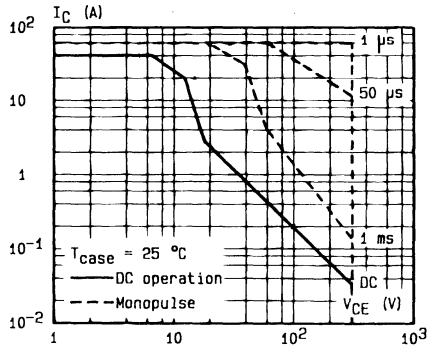

Figure 3b : Turn-off Switching Waveforms (inductive load).



DC and Pulse Area.



Collector-emitter vs. Base Emitter Resistance.

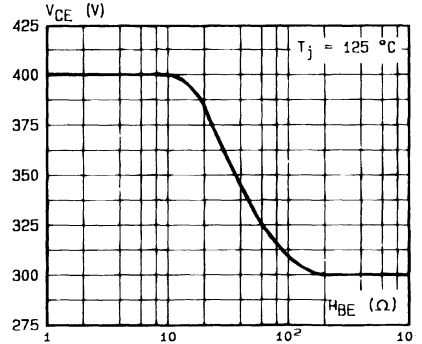

Power and $I_{S/B}$ Derating versus Case Temperature.

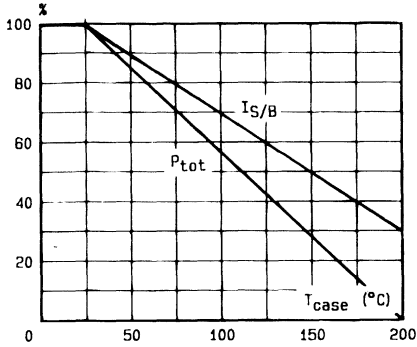

Transient Thermal Response.

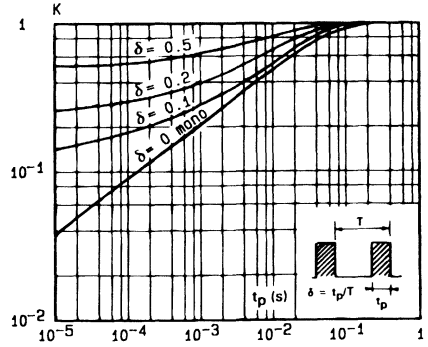

DC Current Gain.

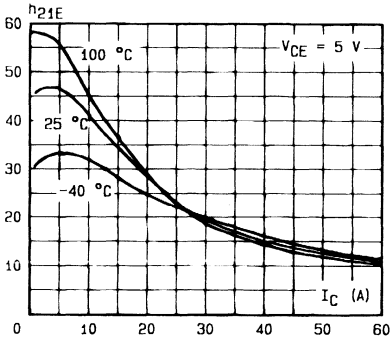

Minimum Base Current to saturate the Transistor.

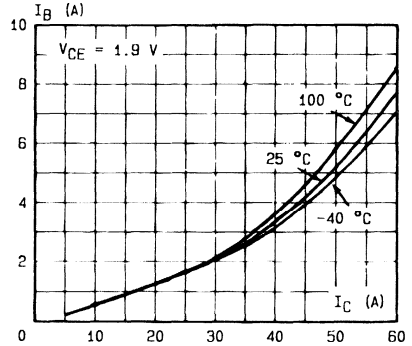

Saturation Voltage.

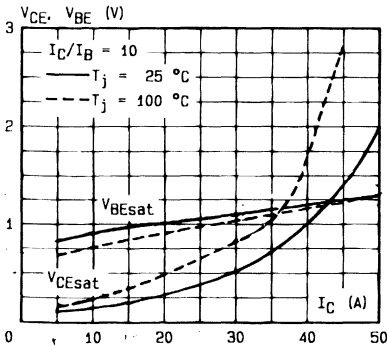

Switching Times versus Collector Current (inductive load).

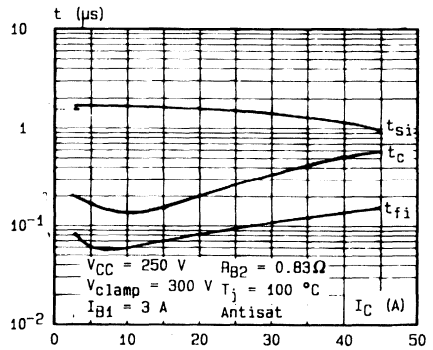

SWITCHING OPERATING AND OVERLOAD AREAS

TRANSISTOR FORWARD BIASED

- During the turn-on
- During the turn-off without negative base-emitter voltage.

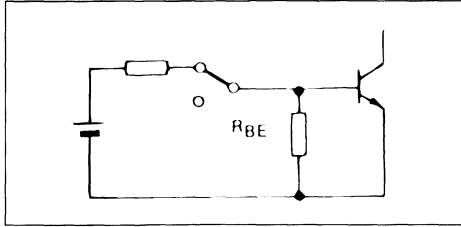

Forward biased Safe Operating Area (FBSOA).

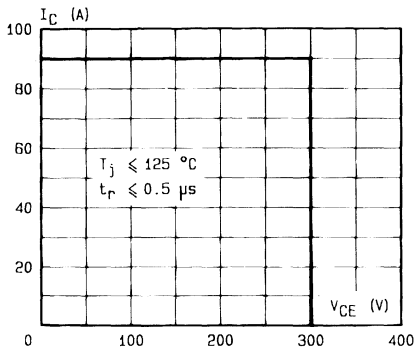

Forward biased Accidental Overload Area (FBAOA).

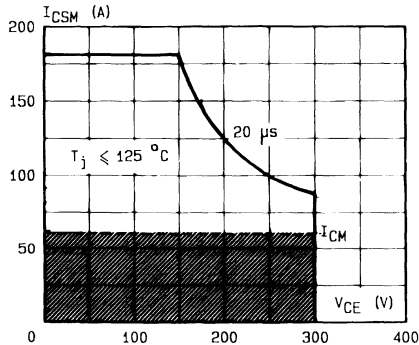

TRANSISTOR REVERSE BIASED

- During the turn-off with negative base-emitter voltage.

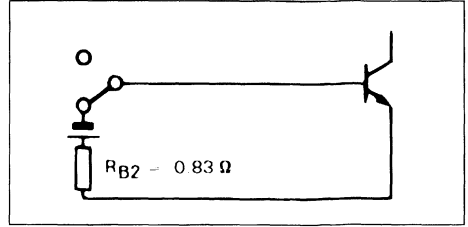

Reverse biased Safe Operating Area (RBSOA).

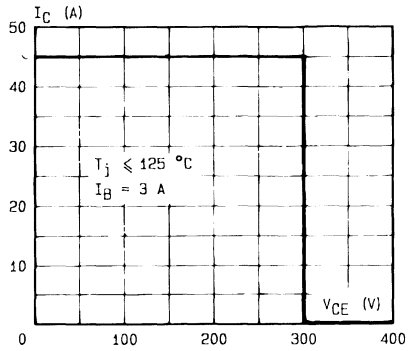

Reverse biased Accidental Overload Area (RBAOA).

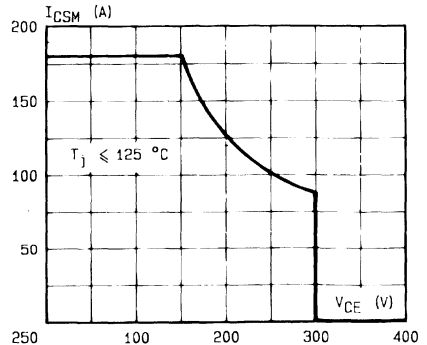

High accidental surge currents ($I > I_{CM}$) are allowed if they are non repetitive and applied less than 3000 times during the component life.

FAST SWITCHING POWER TRANSISTOR

- HIGH EFFICIENCY SWITCHING
- VERY LOW SATURATION VOLTAGE
- RECTANGULAR SAFE OPERATING AREA
- WIDE ACCIDENTAL OVERLOAD AREA

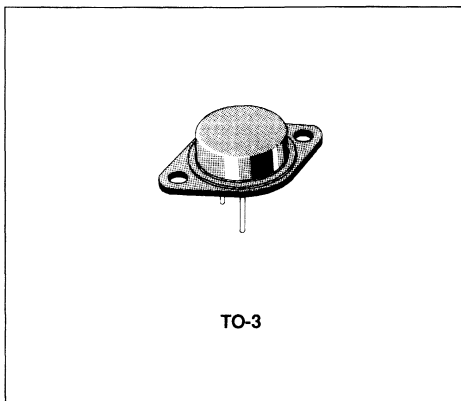

INTERNAL SCHEMATIC DIAGRAM

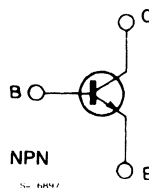

DESCRIPTION

Suitable for motor drives, SMPS converters, uninterruptable power supply operating low voltage supply.

ABSOLUTE MAXIMUM RATINGS

Symbol	Parameter	Value	Unit
V_{CEV}	Collector-emitter Voltage ($V_{BE} = -1.5V$)	200	V
V_{CEO}	Collector-emitter Voltage ($I_B = 0$)	125	V
V_{EBO}	Emitter-base Voltage ($I_C = 0$)	7	V
I_E	Emitter Current	50	A
I_{EM}	Emitter Peak Current	150	A
I_B	Base Current	10	A
I_{BM}	Base Peak Current	30	A
P_{tot}	Total Dissipation at $T_c < 25^\circ C$	300	W
T_{stg}	Storage Temperature	- 65 to 200	$^\circ C$
T_j	Max. Operating Junction Temperature	200	$^\circ C$

THERMAL DATA

$R_{thj-case}$	Thermal Resistance Junction-case	Max	0.58	°C/W
----------------	----------------------------------	-----	------	------

ELECTRICAL CHARACTERISTICS ($T_{case} = 25^{\circ}C$ unless otherwise specified)

Symbol	Parameter	Test Conditions	Min.	Typ.	Max.	Unit
I_{CER}	Collector Cutoff Current ($R_{BE} = 5\Omega$)	$V_{CE} = V_{CEV}$ $V_{CE} = V_{CEV}$ $T_c = 100^{\circ}C$			1 5	mA mA
I_{CEV}	Collector Cutoff Current	$V_{CE} = V_{CEV}$ $V_{BE} = -1.5V$ $V_{CE} = V_{CEV}$ $V_{BE} = -1.5V$ $T_c = 100^{\circ}C$			1 4	mA mA
I_{EBO}	Emitter Cutoff Current ($I_C = 0$)	$V_{EB} = 5V$			1	mA
$V_{CEO(sus)}^*$	Collector Emitter Sustaining Voltage	$I_C = 0.2A$ $L = 25mH$	125			V
V_{EBO}	Emitter-base Voltage ($I_C = 0$)	$I_E = 50mA$	7			V
$V_{CE(sat)}^*$	Collector-emitter Saturation Voltage	$I_C = 50A$ $I_B = 2.5A$ $I_C = 100A$ $I_B = 10A$ $I_C = 50A$ $I_B = 2.5A$ $T_j = 100^{\circ}C$ $I_C = 100A$ $I_B = 10A$ $T_j = 100^{\circ}C$			0.9 0.9 1.2 1.5	V V V V
$V_{BE(sat)}^*$	Base-emitter Saturation Voltage	$I_C = 50A$ $I_B = 2.5A$ $I_C = 100A$ $I_B = 10A$ $I_C = 50A$ $I_B = 2.5A$ $T_j = 100^{\circ}C$ $I_C = 100A$ $I_B = 10A$ $T_j = 100^{\circ}C$			1.4 2 1.4 2.1	V V V V
di_C/dt	Rate of Rise of on-state Collector Current	$V_{CC} = 100V$ $R_C = 0$ $I_{B1} = 5A$ $t_p = 3\mu s$ $T_j = 100^{\circ}C$ See fig. 1	180			A/ μs
t_s t_f t_c	INDUCTIVE LOAD Storage Time Fall Time Crossover Time	$V_{CC} = 90V$ $V_{clamp} = 125V$ $I_C = 50A$ $I_{B1} = 2.5A$ $V_{BB} = -5V$ $L_C = 80\mu H$ $R_{B2} = 1\Omega$ $T_j = 100^{\circ}C$ See fig. 2			2 0.2 0.35	μs μs μs
V_{CEW}	Maximum Collector Emitter Voltage without Snubber	$V_{CC} = 90V$ $I_{Cwoff} = 150A$ $V_{BB} = -5V$ $I_{B1} = 10A$ $L_C = 30\mu H$ $R_{B2} = 1\Omega$ $T_j = 125^{\circ}C$ See fig. 2	125			V

* Pulsed : Pulse duration = $3\mu s$, duty cycle = 2%.

Figure 1 : Turn-on Switching Characteristics of the Transistor.

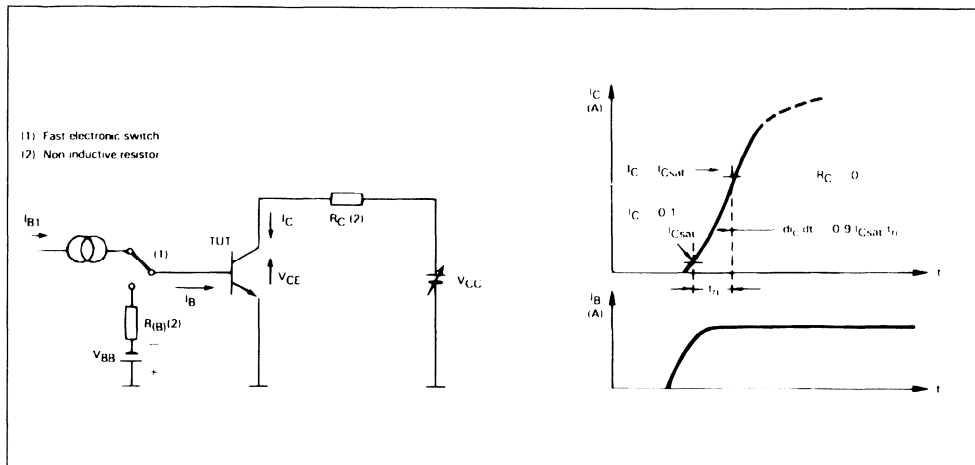
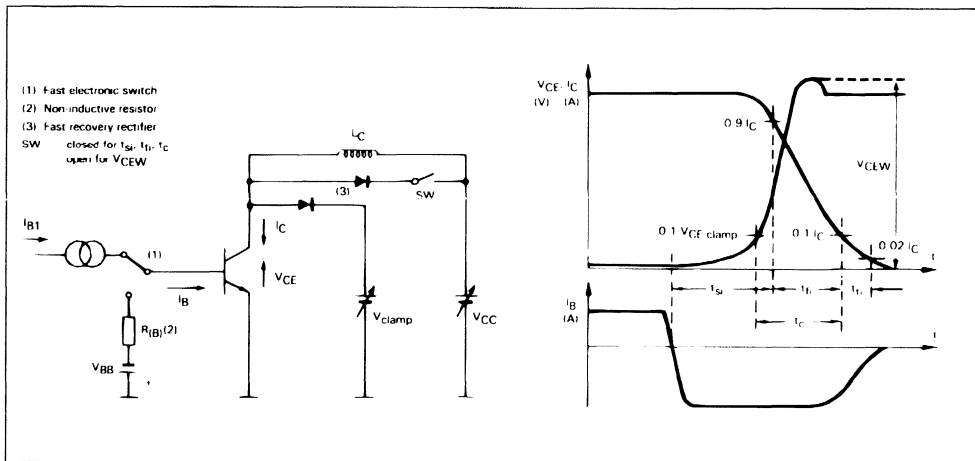
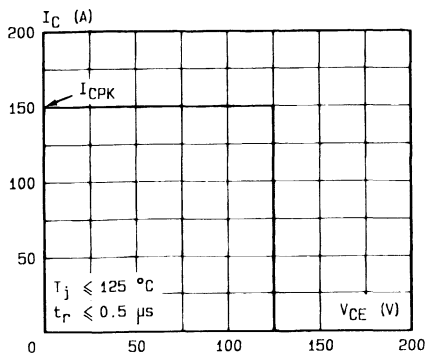

Figure 2 : Turn-off Switching Characteristics of the Transistor.



Forward biased Safe Operating Area (FBSOA).



Reverse biased Safe Operating Area (RBSOA).

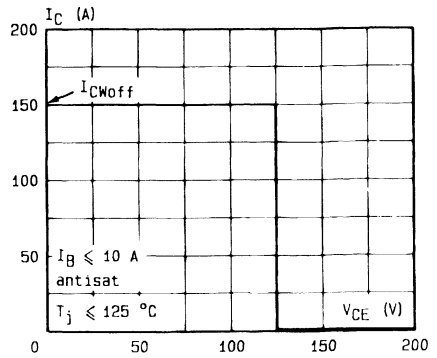

FAST SWITCHING POWER TRANSISTOR

- HIGH EFFICIENCY SWITCHING
- VERY LOW SATURATION VOLTAGE
- RECTANGULAR SAFE OPERATING AREA
- WIDE ACCIDENTAL OVERLOAD AREA

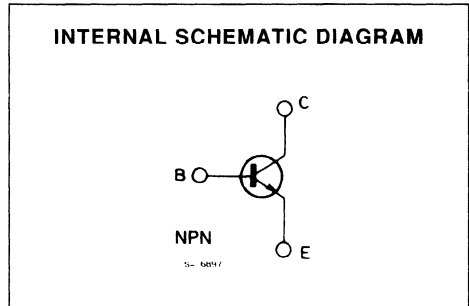
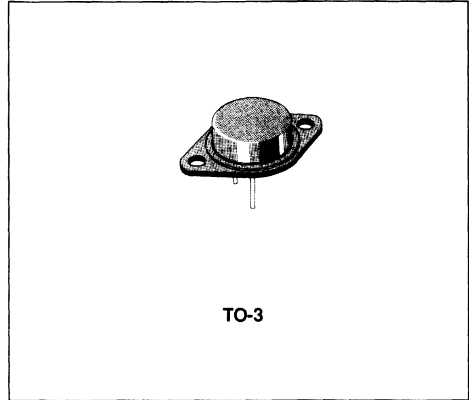
DESCRIPTION

Suitable for motor drives, SMPS converters, uninterruptable power supply operating low voltage supply.

ABSOLUTE MAXIMUM RATINGS

Symbol	Parameter	Value	Unit
V_{CEV}	Collector-emitter Voltage ($V_{BE} = -1.5V$)	400	V
V_{CEO}	Collector-emitter Voltage ($I_B = 0$)	300	V
V_{EBO}	Emitter-base Voltage ($I_C = 0$)	7	V
I_E	Emitter Current	50	A
I_{EM}	Emitter Peak Current	75	A
I_B	Base Current	10	A
I_{BM}	Base Peak Current	15	A
P_{tot}	Total Dissipation at $T_C < 25^\circ C$	300	W
T_{stg}	Storage Temperature	- 65 to 200	$^\circ C$
T_J	Max. Operating Junction Temperature	200	$^\circ C$

THERMAL DATA

$R_{th\ j-case}$	Thermal Resistance Junction-case	Max	0.58	°C/W
------------------	----------------------------------	-----	------	------

ELECTRICAL CHARACTERISTICS ($T_{case} = 25^{\circ}C$ unless otherwise specified)

Symbol	Parameter	Test Conditions	Min.	Typ.	Max.	Unit
I_{CER}	Collector Cutoff Current ($R_{BE} = 10\Omega$)	$V_{CE} = V_{CEV}$ $V_{CE} = V_{CEV}$ $T_C = 100^{\circ}C$			1 5	mA mA
I_{CEV}	Collector Cutoff Current	$V_{CE} = V_{CEV}$ $V_{BE} = -1.5V$ $V_{CE} = V_{CEV}$ $V_{BE} = -1.5V$ $T_C = 100^{\circ}C$			1 4	mA mA
I_{EBO}	Emitter Cutoff Current ($I_C = 0$)	$V_{EB} = 5V$			1	mA
$V_{CEO(sus)*}$	Collector Emitter Sustaining Voltage	$I_C = 0.2A$ $L = 25mH$	300			V
V_{EBO}	Emitter-base Voltage ($I_C = 0$)	$I_E = 50mA$	7			V
$V_{CE(sat)*}$	Collector-emitter Saturation Voltage	$I_C = 40A$ $I_B = 4A$ $I_C = 40A$ $I_B = 4A$ $T_j = 100^{\circ}C$			0.9 1.9	V V
$V_{BE(sat)*}$	Base-emitter Saturation Voltage	$I_C = 40A$ $I_B = 4A$ $I_C = 40A$ $I_B = 4A$ $T_j = 100^{\circ}C$			1.4 1.4	V V
di_C/dt	Rated of Rise of On-state Collector Current	$V_{CC} = 250V$ $R_C = 0$ $t_p = 3\mu s$ See fig. 1		120		A/ μs
t_s t_f t_c	INDUCTIVE LOAD Storage Time Fall Time Crossover Time	$V_{CC} = 250V$ $V_{clamp} = 300V$ $I_C = 40A$ $I_{B1} = 4A$ $V_{BB} = -5V$ $L_C = 0.3mH$ $R_{B2} = 0.60\Omega$ $T_j = 100^{\circ}C$ See fig. 2			3 0.4 0.7	μs μs μs
V_{CEW}	Maximum Collector Emitter Voltage without Snubber	$V_{CC} = 50V$ $I_{CWOFF} = 60A$ $V_{BB} = -5V$ $I_{B1} = 4A$ $L_C = 42\mu H$ $R_{B2} = 0.6\Omega$ $T_j = 125^{\circ}C$ See fig. 2	300			V

* Pulsed : Pulse duration = 300 μs , duty cycle = 2%.

Figure 1 : Turn-on Switching Characteristics of the Transistor.

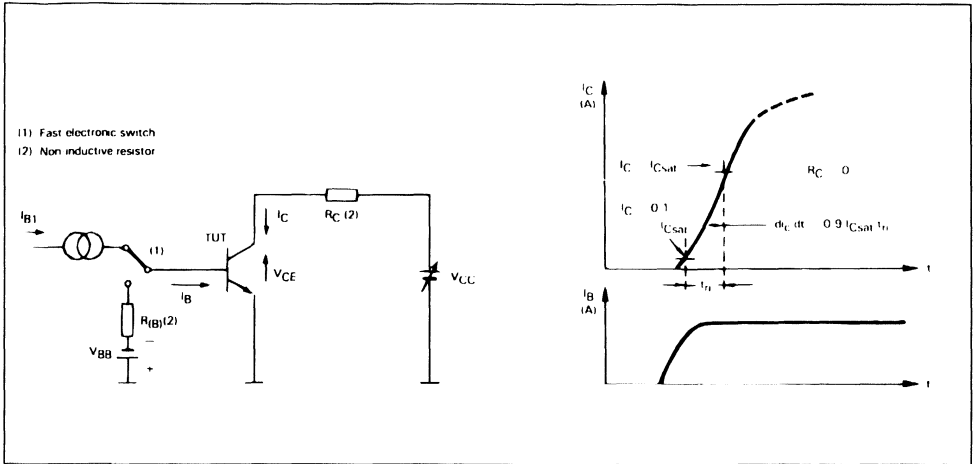
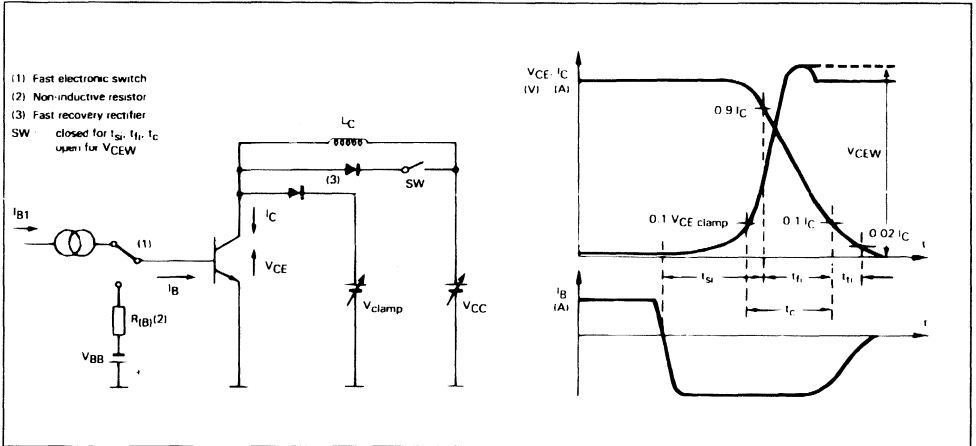
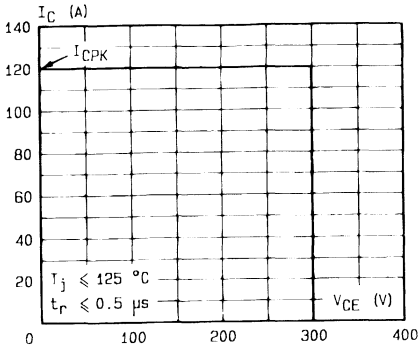

Figure 2 : Turn-off Switching Characteristics of the Transistor.



Forward biased Safe Operating Area (FBSOA).



Reverse biased Safe Operating Area (RBSOA).

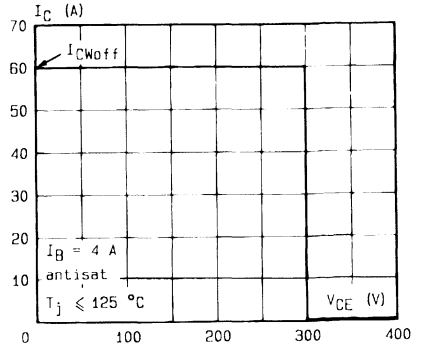

NPN HIGH CURRENT SWITCHING TRANSISTORS

- HIGH EFFICIENCY SWITCHING
- VERY LOW SATURATION VOLTAGE AT 40A
- FAST TURN-OFF AND TURN-ON

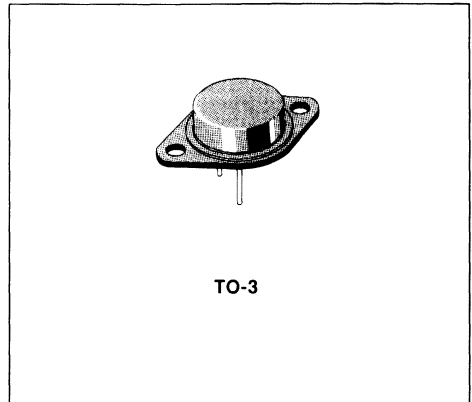

INTERNAL SCHEMATIC DIAGRAM

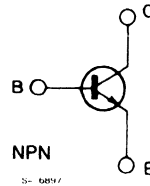

DESCRIPTION

High current, high speed transistors suited for low voltage applications : high efficiency converters, motor controls.

ABSOLUTE MAXIMUM RATINGS

Symbol	Parameter	Value		Unit
		BUV18	BUV19	
V_{CBO}	Collector-base Voltage ($I_E = 0$)	120	160	V
V_{CEO}	Collector-emitter Voltage ($I_B = 0$)	60	80	V
V_{EBO}	Emitter-base Voltage ($I_C = 0$)	7	7	V
I_C	Collector Current	50	50	A
I_{CM}	Collector Peak Current ($t_p < 5ms$)	90	70	A
I_B	Base Current	16	12	A
I_{BM}	Base Peak Current ($t_p < 5ms$)	40	30	A
P_{tot}	Total Dissipation at $T_C < 25^\circ C$	250		W
T_{stg}	Storage Temperature	- 65 to 200		$^\circ C$
T_j	Max. Operating Junction Temperature	200		$^\circ C$

THERMAL DATA

$R_{thj-case}$	Thermal Resistance Junction-case	max	0.7	°C/W
----------------	----------------------------------	-----	-----	------

ELECTRICAL CHARACTERISTICS ($T_{case} = 25^{\circ}\text{C}$ unless otherwise specified)

Symbol	Parameter	Test Conditions	Min.	Typ.	Max.	Unit
I_{CEX}	Collector Cutoff Current	$V_{CE} = V_{CEX}$ $V_{BE} = -1.5\text{V}$ $V_{CE} = V_{CEX}$ $V_{BE} = -1.5\text{V}$ $T_c = 100^{\circ}\text{C}$			1 3	mA mA
I_{EBO}	Emitter Cutoff Current ($I_C = 0$)	$V_{EB} = 5\text{V}$			1	mA
$V_{CE0(sus)}^*$	Collector Emitter Sustaining Voltage	$I_C = 0.2\text{A}$ $L = 25\text{mH}$ for BUV18 for BUV19	60 80			V V
V_{EBO}	Emitter-base Voltage ($I_C = 0$)	$I_E = 50\text{mA}$	7			V
$V_{CE(sat)}^*$	Collector-emitter Saturation Voltage	$I_C = 40\text{A}$ $I_B = 4\text{A}$ for BUV18 $I_C = 80\text{A}$ $I_B = 8\text{A}$ for BUV18 $I_C = 30\text{A}$ $I_B = 3\text{A}$ for BUV19 $I_C = 60\text{A}$ $I_B = 6\text{A}$ for BUV19			0.6 1.5 0.6 1.2	V V V V
$V_{BE(sat)}^*$	Base-emitter Saturation Voltage	$I_C = 80\text{A}$ $I_B = 8\text{A}$ for BUV18 $I_C = 60\text{A}$ $I_B = 6\text{A}$ for BUV19			2.2 2	V V
f_T	Transition Frequency	$f = 10\text{MHz}$ $V_{CE} = 15\text{A}$ $I_C = 2\text{A}$	8			MHz

RESISTIVE LOAD

Symbol	Parameter	Test Conditions	Min.	Typ.	Max.	Unit
t_{on}	Turn-on Time	for BUV18		1.2	1.5	μs
t_s	Storage Time	$V_{CC} = 60\text{V}$ $I_C = 80\text{A}$		0.6	1.1	μs
t_f	Fall Time	$I_{B1} = -I_{B2} = 8\text{A}$		0.18	0.25	μs
t_s	Storage Time	for BUV18			1.7	μs
t_f	Fall Time	$V_{CC} = 60\text{V}$ $I_C = 80\text{A}$ $I_{B1} = -I_{B2} = 8\text{A}$ $T_c = 125^{\circ}\text{C}$			0.5	μs
t_{on}	Turn-on Time	for BUV19		0.9	1.3	μs
t_s	Storage Time	$V_{CC} = 80\text{V}$ $I_C = 60\text{A}$		0.6	1.1	μs
t_f	Fall Time	$I_{B1} = -I_{B2} = 6\text{A}$		0.17	0.25	μs
t_s	Storage Time	for BUV19			1.7	μs
t_f	Fall Time	$V_{CC} = 80\text{V}$ $I_C = 60\text{A}$ $I_{B1} = -I_{B2} = 6\text{A}$ $T_c = 125^{\circ}\text{C}$			0.5	μs

* Pulsed : Pulse duration = 300 μs , duty cycle = 2%

DC and AC Pulse Area.

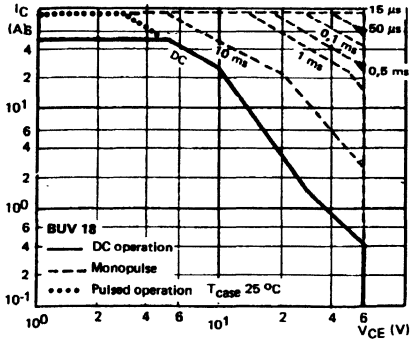

DC and AC Pulse Area.

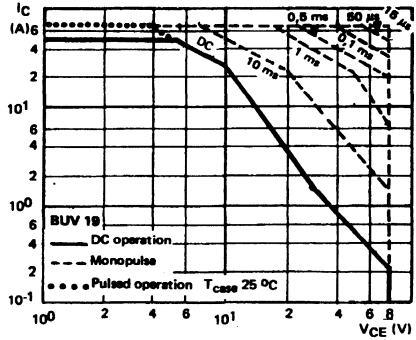

Collector-emitter Voltage vs. Base-emitter Resistance.

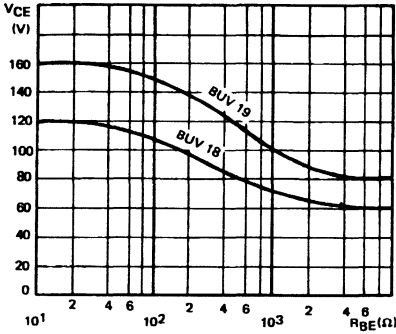

Transient Thermal Response.

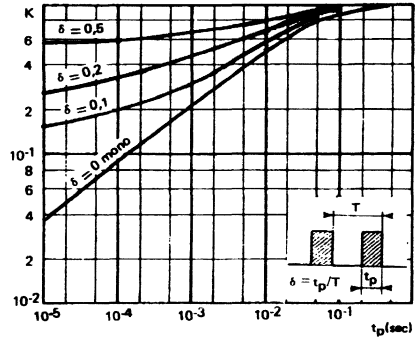

Power and $I_{S/B}$ Derating vs. Case Temperature.

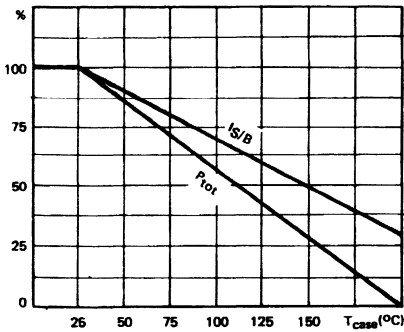

DC Current Gain.

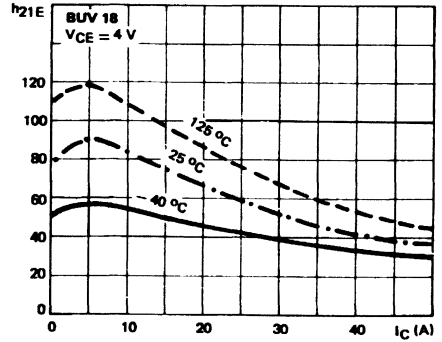

Minimum Base Current to Saturate the Transistor.

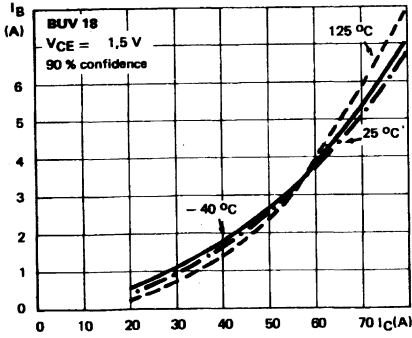

Base Characteristics.

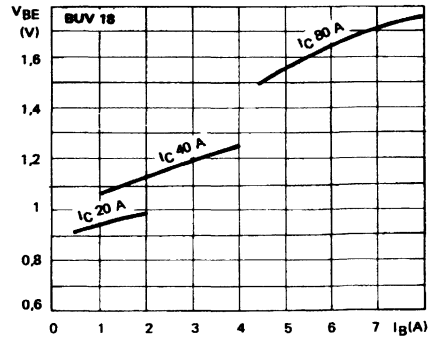

Collector Saturation Region.

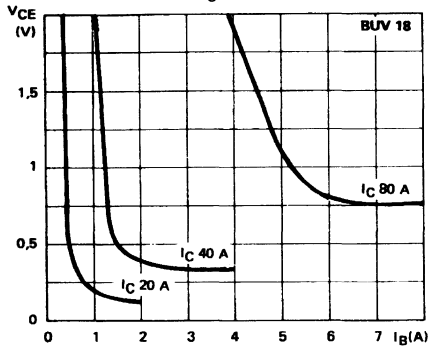

Saturation Voltage.

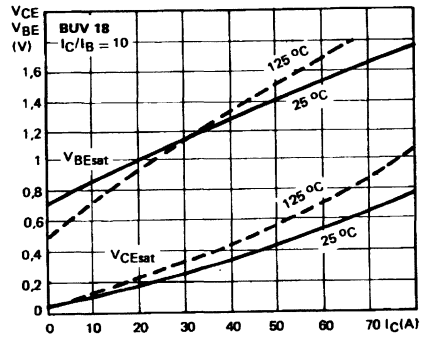

Collector Current Spread vs Base Emitter Voltage.

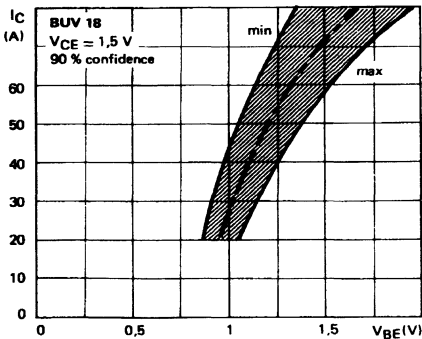

DC Current Gain.

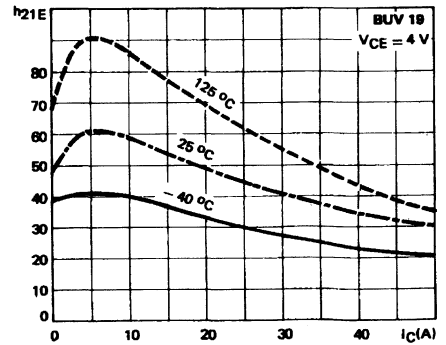

Minimum Base Current to Saturate the Transistor.

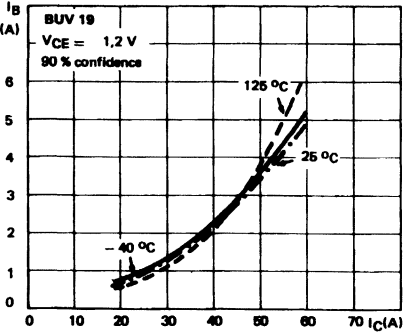

Base Characteristics.

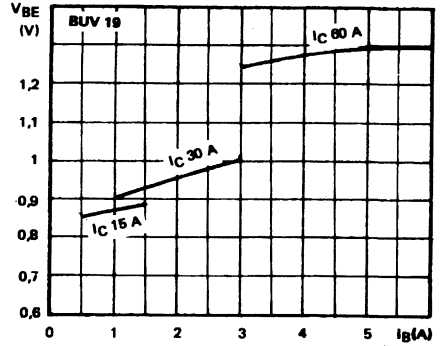

Collector Saturation Region.

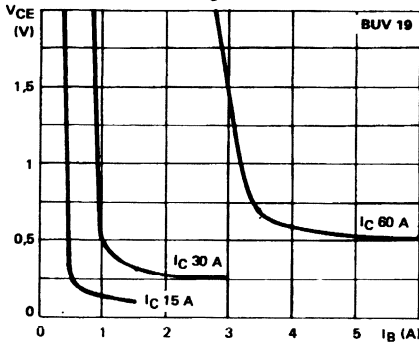

Saturation Voltage.

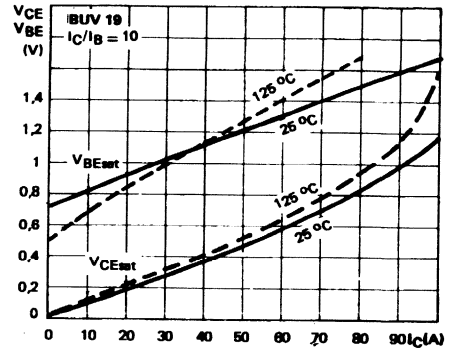

Collector Current Spread vs Base Emitter Voltage.

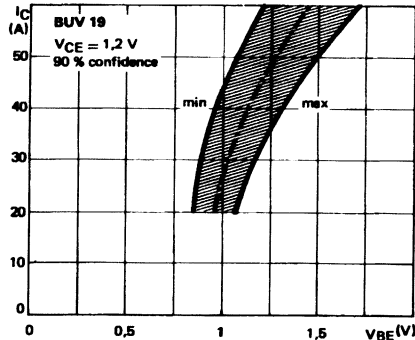

SWITCHING OPERATING AND OVERLOAD AREAS

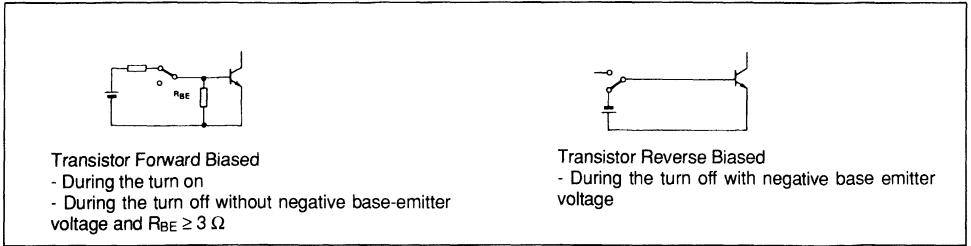

Forward Biased Safe Operating Area (FBSOAR).

Reverse Biased Safe Operating Area (RBSOAR).

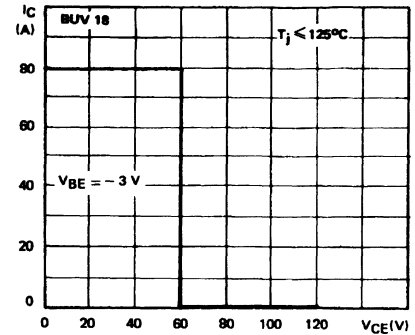
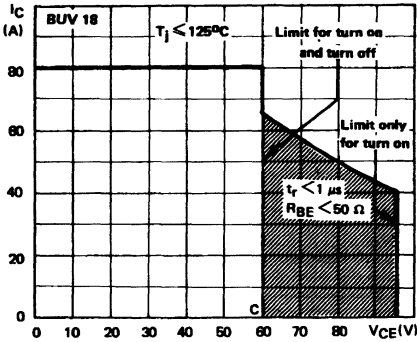

The hatched zone can only be used for turn on.

Forward Biased Accidental Overload Area (FBAOA).

Reverse Biased Accidental Overload Area (RBAOA).

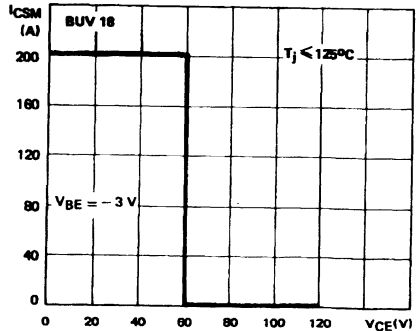
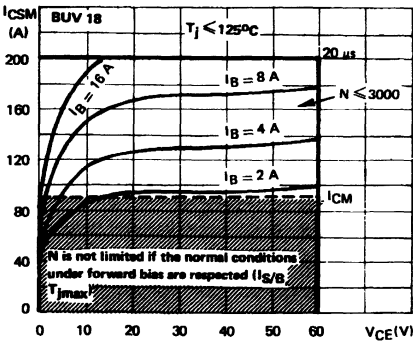

The Kellogg network (heavy print) allows the calculation of the maximum value of the short-circuit current for a given base current I_B (90 % confidence).

After the accidental overload current, the RBAOA has to be used for the turn off.

High accidental surge currents ($I > I_{CM}$) are allowed if they are non repetitive and applied less than 3000 times during the component life.

Forward Biased Safe Operating Area (FBSOAR).

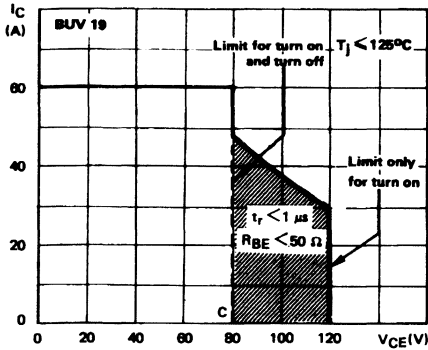

The hatched zone can only be used for turn on.

Reverse Biased Safe Operating Area (RBSOAR).

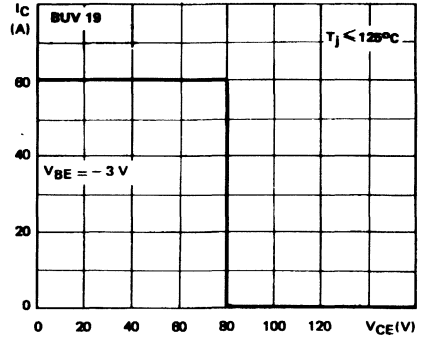

Forward Biased Accidental Overload Area (FBAOA).

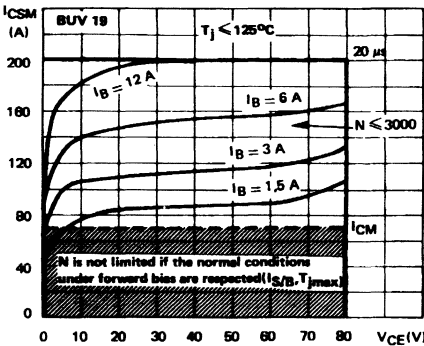

The Kellog network (heavy print) allows the calculation of the maximum value of the short-circuit current for a given base current I_B (90 % confidence).

High accidental surge currents ($I > I_{CM}$) are allowed if they are non repetitive and applied less than 3000 times during the component life.

Reverse Biased Accidental Overload

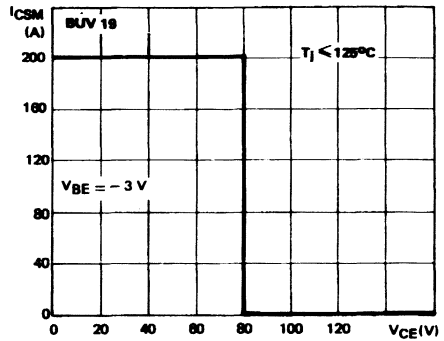

After the accidental overload current, the RBAOA has to be used for the turn off.

Switching Times vs Collector Current (resistive load).

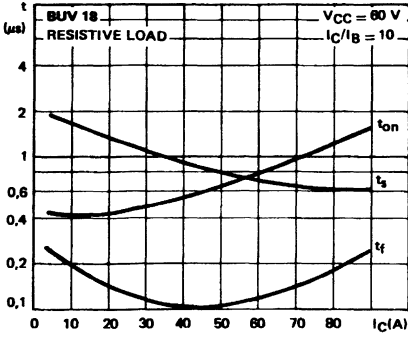

Switching Times vs Collector Current (resistive load).

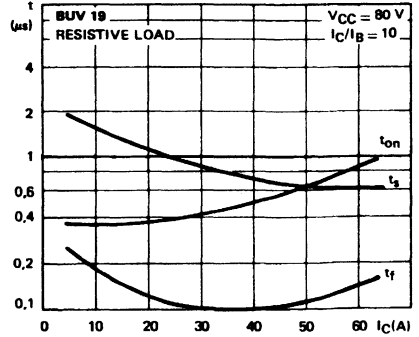

Switching Times vs Collector Current.

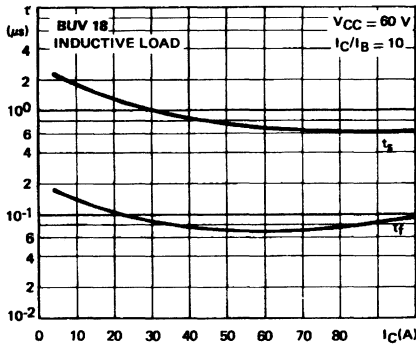

Switching Times vs Collector Current.

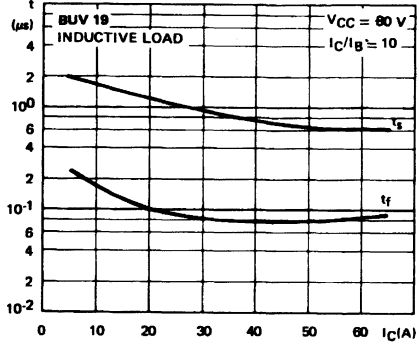

Switching Times vs Junction Temperature.

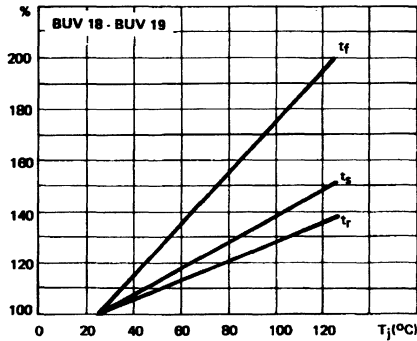

HIGH CURRENT POWER SWITCH

DESCRIPTION

The BUV20, BUV21 and BUV22 are silicon multi-epitaxial planar NPN transistor in jedec TO-3 metal case, intended for use in switching and linear applications in military and industrial equipment.

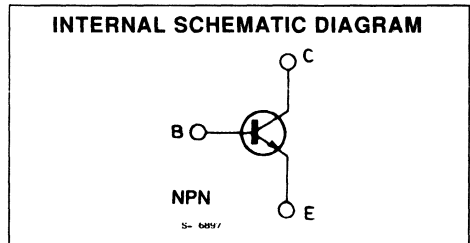
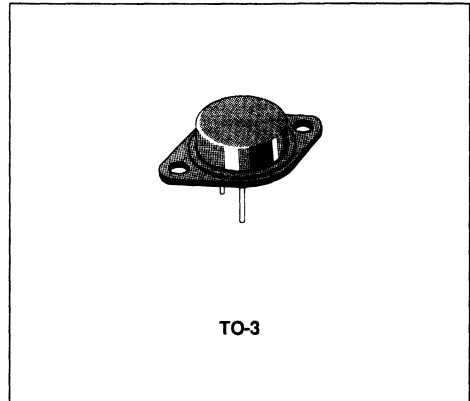

ABSOLUTE MAXIMUM RATINGS

Symbol	Parameter	Value			Unit
		BUV20	BUV21	BUV22	
V_{CBO}	Collector-base Voltage ($I_E = 0$)	160	250	300	V
V_{CER}	Collector-emitter Voltage ($R_{BE} = 100 \Omega$)	150	240	290	V
V_{CEX}	Collector-emitter Voltage ($V_{BE} = -1.5$ V)	160	250	300	V
V_{CEO}	Collector-emitter Voltage ($I_B = 0$)	125	200	250	V
V_{EBO}	Emitter-base Voltage ($I_C = 0$)	7	7	7	V
I_C	Collector Current	50	40	40	A
I_{CM}	Collector Peak Current	60	50	50	A
I_B	Base Current	10	8	8	A
P_{tot}	Total Power Dissipation at $T_{case} \leq 25^\circ C$	250			W
T_{stg}	Storage Temperature	- 65 to 200			$^\circ C$
T_j	Junction Temperature	200			$^\circ C$

THERMAL DATA

$R_{th\ j-case}$	Thermal Resistance Junction-case	Max	0.7	°C/W
------------------	----------------------------------	-----	-----	------

ELECTRICAL CHARACTERISTICS ($T_{case} = 25\text{ °C}$ unless otherwise specified)

Symbol	Parameter	Test Conditions	Min.	Typ.	Max.	Unit
I_{CEO}	Collector Cutoff Current ($I_B = 0$)	for BUV20 $V_{CE} = 100\text{ V}$ for BUV21 $V_{CE} = 160\text{ V}$ for BUV22 $V_{CE} = 200\text{ V}$			3 3 3	mA mA mA
I_{CEX}	Collector Cutoff Current ($V_{BE} = -1.5\text{ A}$)	$V_{CE} = V_{CEX}$ for BUV20 for BUV21 for BUV22 at $T_{case} = 125\text{ °C}$ for BUV20 for BUV21 for BUV22			3 3 3 12 12 12	mA mA mA mA mA mA
I_{EBO}	Emitter Cutoff Current ($I_C = 0$)	$V_{EB} = 5\text{ V}$			1	mA
$V_{CEO(sus)}^*$	Collector-emitter Sustaining Voltage ($I_B = 0$)	$I_C = 200\text{ mA}$ $L = 25\text{ mH}$ for BUV20 for BUV21 for BUV22	125 200 250			V V V
$V_{(BR)EBO}^*$	Emitter-base Breakdown Voltage ($I_C = 0$)	$I_E = 50\text{ mA}$	7			V
$V_{CE(sat)}^*$	Collector-emitter Saturation Voltage	for BUV20 $I_C = 25\text{ A}$ $I_B = 2.5\text{ A}$ $I_C = 50\text{ A}$ $I_B = 5\text{ A}$ for BUV21 $I_C = 12\text{ A}$ $I_B = 1.2\text{ A}$ $I_C = 25\text{ A}$ $I_B = 3\text{ A}$ for BUV22 $I_C = 10\text{ A}$ $I_B = 1\text{ A}$ $I_C = 20\text{ A}$ $I_B = 2.5\text{ A}$		0.3 0.7 0.2 0.9 0.2 0.5	0.6 1.2 0.6 1.5 1 1.5	V V V V V V
$V_{BE(sat)}^*$	Base-emitter Saturation Voltage	for BUV20 $I_C = 50\text{ A}$ $I_B = 5\text{ A}$ for BUV21 $I_C = 25\text{ A}$ $I_B = 3\text{ A}$ for BUV22 $I_C = 40\text{ A}$ $I_B = 4\text{ A}$		1.4 1.2 1.2	2 1.5 1.5	V V V
h_{FE}^*	DC Current Gain	for BUV20 $V_{CE} = 2\text{ V}$ $I_C = 25\text{ A}$ $V_{CE} = 4\text{ V}$ $I_C = 50\text{ A}$ for BUV21 $V_{CE} = 2\text{ V}$ $I_C = 12\text{ A}$ $V_{CE} = 4\text{ V}$ $I_B = 25\text{ A}$ for BUV22 $V_{CE} = 4\text{ V}$ $I_C = 10\text{ A}$ $V_{CE} = 4\text{ V}$ $I_C = 20\text{ A}$	20 10 20 10 20 10		60 60 60	
f_T	Transition Frequency	$V_{CE} = 15\text{ V}$ $f = 100\text{ MHz}$ $I_C = 2\text{ A}$	8			MHz

* Pulsed, pulse duration = 300 μ s, duty cycle $\leq 2\%$.

ELECTRICAL CHARACTERISTICS (continued)

Symbol	Parameter	Test Conditions	Min.	Typ.	Max.	Unit
t_{on}	Turn-on Time	for BUV20 $I_C = 50\text{ A}$ $I_B = 5\text{ A}$ for BUV21 $I_C = 25\text{ A}$ $I_B = 3\text{ A}$ for BUV22 $I_C = 20\text{ A}$ $I_B = 2.5\text{ A}$			1.5 1.2 1.3	μs μs μs
t_f	Fall Time	for BUV20 $I_C = 50\text{ A}$ $I_{B1} = -I_{B2} = 5\text{ A}$ for BUV21 $I_C = 25\text{ A}$ $I_{B1} = -I_{B2} = 3\text{ A}$ for BUV22 $I_C = 20\text{ A}$ $I_{B1} = -I_{B2} = 2.5\text{ A}$			0.3 0.4 0.5	μs μs μs
t_s	Storage Time	for BUV20 $I_C = 50\text{ A}$ $I_{B1} = -I_{B2} = 5\text{ A}$ for BUV21 $I_C = 25\text{ A}$ $I_{B1} = -I_{B2} = 3\text{ A}$ for BUV22 $I_C = 20\text{ A}$ $I_{B1} = -I_{B2} = 2.5\text{ A}$			1.2 1.8 2	μs μs μs

* Pulsed. pulse duration = 300 μs , duty cycle $\leq 2\%$.

POWER SWITCH
DESCRIPTION

The BUV23, BUV24 and BUV25 are silicon multi-epitaxial mesa NPN transistors in Jedec TO-3 metal case, intended for use in power switching applications in military and industrial equipments.

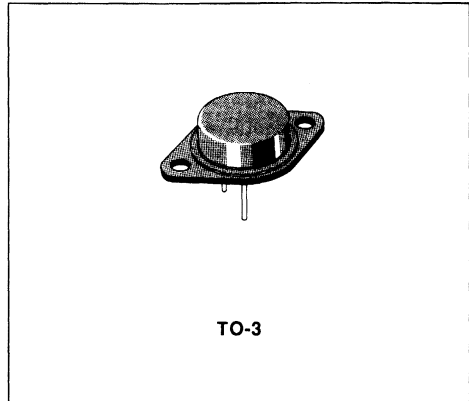
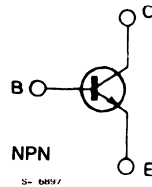
INTERNAL SCHEMATIC DIAGRAM

ABSOLUTE MAXIMUM RATINGS

Symbol	Parameter	Value			Unit
		BUV23	BUV24	BUV25	
V_{CBO}	Collector-base Voltage ($I_E = 0$)	400	450	500	V
V_{CER}	Collector-emitter Voltage ($R_{BE} = 100 \Omega$)	390	440	500	V
V_{CEX}	Collector-emitter Voltage ($V_{BE} = -1.5$ V)	400	450	500	V
V_{CEO}	Collector-emitter Voltage ($I_B = 0$)	325	400	500	V
V_{EBO}	Emitter-base Voltage ($I_C = 0$)	7	7	7	V
I_C	Collector Current	30	20	15	A
I_{CM}	Collector Peak Current ($t_p = 10$ ms.)	40	30	20	A
I_B	Base Current	6	4	3	A
P_{tot}	Total Power Dissipation at $T_{case} \leq 25$ °C	250			W
T_{stg}	Storage Temperature	- 65 to 200			°C
T_j	Junction Temperature	200			°C

THERMAL DATA

$R_{th\text{-}case}$	Thermal Resistance Junction-case	max	0.7	$^{\circ}\text{C}/\text{W}$
----------------------	----------------------------------	-----	-----	-----------------------------

ELECTRICAL CHARACTERISTICS ($T_{case} = 25^{\circ}\text{C}$ unless otherwise specified)

Symbol	Parameter	Test Conditions	Min.	Typ.	Max.	Unit
I_{CEO}	Collector Cutoff Current ($I_B = 0$)	$V_{CE} = 260\text{ V}$ for BUV23 $V_{CE} = 320\text{ V}$ for BUV24 $V_{CE} = 400\text{ V}$ for BUV25			3 3 3	mA mA mA
I_{CEX}	Collector Cutoff Current ($V_{BE} = -1.5\text{ V}$)	$V_{CE} = V_{CEX}$ $T_{case} = 125^{\circ}\text{C}$ $V_{CE} = V_{CEX}$			3 12	mA mA
I_{EBO}	Emitter Cutoff Current ($I_C = 0$)	$V_{EB} = 5\text{ V}$			1	mA
$V_{CE(sat)}^*$	Collector-emitter Saturation Voltage	for BUV23 $I_C = 8\text{ A}$ $I_B = 1.6\text{ A}$ $I_C = 16\text{ A}$ $I_B = 3.2\text{ A}$ for BUV24 $I_C = 6\text{ A}$ $I_B = 1.2\text{ A}$ $I_C = 12\text{ A}$ $I_B = 2.4\text{ A}$ for BUV25 $I_C = 4\text{ A}$ $I_B = 0.8\text{ A}$ $I_C = 8\text{ A}$ $I_B = 1.6\text{ A}$		0.2 0.35 0.15 0.3 0.2 0.6	0.8 1 0.6 1 0.6 1	V V V V V V
$V_{BE(sat)}^*$	Base-emitter Saturation Voltage	for BUV23 $I_C = 16\text{ A}$ $I_B = 3.2\text{ A}$ for BUV24 $I_C = 12\text{ A}$ $I_B = 2.4\text{ A}$ for BUV25 $I_C = 8\text{ A}$ $I_B = 1.6\text{ A}$		1.15 1 1.2	1.5 1.15 1.5	V V V
$V_{CEO(sus)}^*$	Collector-emitter Sustaining Voltage	$I_C = 200\text{ mA}$ $L = 25\text{ mH}$ for BUV23 for BUV24 for BUV25	325 400 500			V V V
$V_{(BR)EBO}^*$	Emitter-base Breakdown Voltage ($I_C = 0$)	$I_E = 50\text{ mA}$	7			V
h_{FE}^*	DC Current Gain	$V_{CE} = 4\text{ V}$ for BUV23 $I_C = 8\text{ A}$ $I_C = 16\text{ A}$ $V_{CE} = 4\text{ V}$ for BUV24 $I_C = 6\text{ A}$ $I_C = 12\text{ A}$ $V_{CE} = 4\text{ V}$ for BUV25 $I_C = 4\text{ A}$ $I_C = 8\text{ A}$	15 8 15 8 15 8		60 60 60	
f_T	Transition Frequency	$V_{CE} = 15\text{ V}$ $I_C = 2\text{ A}$ $f = 10\text{ MHz}$	8			MHz
t_{on}	Turn-on Time	for BUV23 $I_C = 16\text{ A}$ $I_B = 3.2\text{ A}$ for BUV24 $I_C = 12\text{ A}$ $I_B = 2.4\text{ A}$ for BUV25 $I_C = 8\text{ A}$ $I_B = 1.6\text{ A}$		0.55 0.6 0.9	1.3 1.6 1.8	μs μs μs

* Pulsed : pulse duration = 300 μs , duty cycle $\leq 2\%$.

ELECTRICAL CHARACTERISTICS (continued)

Symbol	Parameter	Test Conditions	Min.	Typ.	Max.	Unit
t_f	Fall Time	for BUV23 $I_C = 16\text{ A}$	$I_{B1} = -I_{B2} = 3.2\text{ A}$	0.26	1.2	μs
		for BUV24 $I_C = 12\text{ A}$				
		for BUV25 $I_C = 8\text{ A}$				
t_s	Storage Time	for BUV23 $I_C = 16\text{ A}$	$I_{B1} = -I_{B2} = 3.2\text{ A}$	1.7	2.5	μs
		for BUV24 $I_C = 12\text{ A}$				
		for BUV25 $I_C = 8\text{ A}$				

* Pulsed : pulse duration = 300 μs , duty cycle $\leq 2\%$.

NPN FAST SWITCHING TRANSISTOR

- LOW SATURATION VOLTAGE
- FAST TURN-ON AND TURN-OFF
- BASE DRIVE SPECIFIED FOR DIFFERENT VALUES OF I_C
- WIDE SURGE AREA

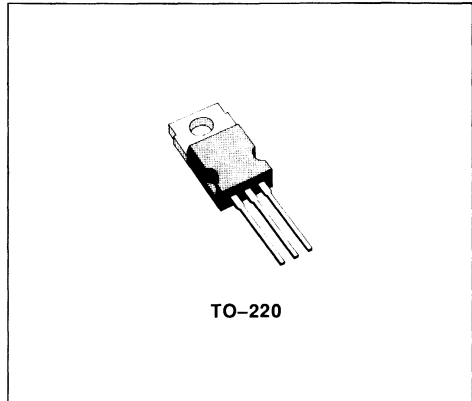

INTERNAL SCHEMATIC DIAGRAM

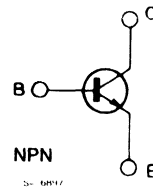

DESCRIPTION

High speed transistor suited for low voltage applications.

High frequency and efficiency converters switching regulators motor control.

ABSOLUTE MAXIMUM RATINGS

Symbol	Parameter	Value	Unit
V_{CBO}	Collector-base Voltage ($I_E = 0$)	180	V
V_{CEO}	Collector-emitter Voltage ($I_B = 0$)	90	V
V_{EBO}	Emitter-base Voltage ($I_C = 0$)	7	V
I_C	Collector Current	14	A
I_{CM}	Collector Peak Current ($t_p < 10ms$)	25	A
I_B	Base Current	4	A
I_{BM}	Base Peak Current ($t_p < 10ms$)	6	A
P_{tot}	Total Dissipation at $T_c < 25^\circ C$	85	W
P_{tot}	Total Dissipation at $T_c < 60^\circ C$	65	W
T_{stg}	Storage Temperature	- 65 to + 175	$^\circ C$
T_j	Max. Operating Junction Temperature	175	$^\circ C$

THERMAL DATA

$R_{thj-case}$	Thermal Resistance Junction-case	Max	1.76	°C/W
----------------	----------------------------------	-----	------	------

ELECTRICAL CHARACTERISTICS ($T_{case} = 25^{\circ}C$ unless otherwise specified)

Symbol	Parameter	Test Conditions	Min.	Typ.	Max.	Unit
I_{CER}	Collector Cutoff Current ($R_{BE} = 50\Omega$)	$V_{CE} = 180V$ $T_C = 125^{\circ}C$			3	mA
I_{CEX}	Collector Cutoff Current	$V_{CE} = 180V$ $V_{BE} = -1.5V$ $T_C = 125^{\circ}C$			1	mA
I_{EBO}	Emitter Cutoff Current ($I_C = 0$)	$V_{EB} = 5V$			1	mA
$V_{CEO(sus)}^*$	Collector Emitter Sustaining Voltage	$I_C = 0.2A$ $L = 25mH$	90			V
V_{EBO}	Emitter-base Voltage ($I_C = 0$)	$I_E = 50mA$	7		30	V
$V_{CE(sat)}^*$	Collector-emitter Saturation Voltage	$I_C = 6A$ $I_B = 0.6A$ $I_C = 12A$ $I_B = 1.2A$			0.6 1.5	V V
$V_{BE(sat)}^*$	Base-emitter Saturation Voltage	$I_C = 12A$ $I_B = 1.2A$			2	V
t_{on} t_s t_f	RESISTIVE LOAD Turn-on Time Storage Time Fall Time	$V_{CC} = 50V$ $I_C = 12A$ $V_{BE} = -6V$ $I_{B1} = 1.2A$ $R_{BB} = 2.5\Omega$		0.4 0.45 0.12	0.6 1 0.25	μs μs μs
t_s t_f	INDUCTIVE LOAD Storage Time Fall Time	$V_{CC} = 50V$ $I_C = 12A$ $V_{BE} = -5V$ $I_{B1} = 1.2A$ $L_B = 0.5\mu H$		0.5 0.04		μs μs
t_s t_f	Storage Time Fall Time	$V_{CC} = 50V$ $I_C = 12A$ $V_{BE} = -5V$ $I_{B1} = 1.2A$ $L_B = 0.5\mu H$ $T_j = 125^{\circ}C$			2 0.15	μs μs

* Pulsed : Pulse duration = 300 μs , duty cycle = 1.5%

DC and Pulse Area.

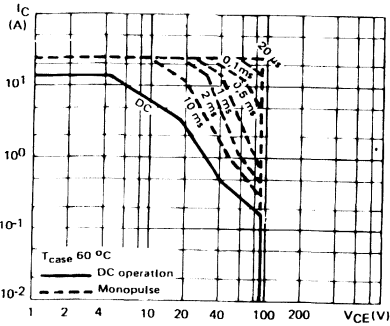

Collector-emitter Voltage vs Base-emitter Resistance.

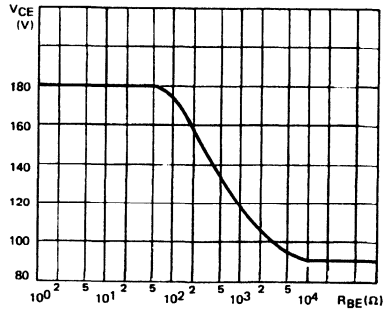

Power and $I_{S/B}$ Derating vs Case Temperature.

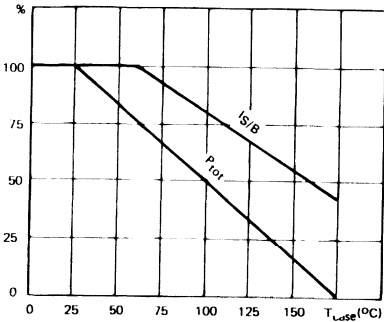

Transient Thermal Response.

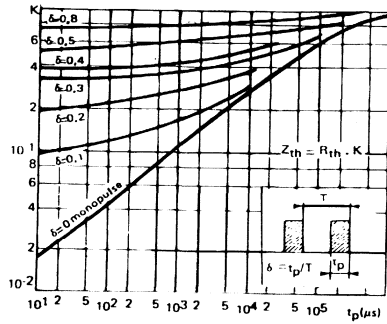

DC Current Gain.

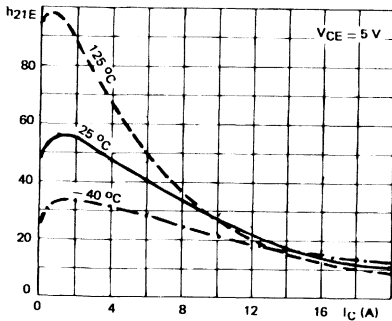

Minimum Base Current to saturate the transistor.

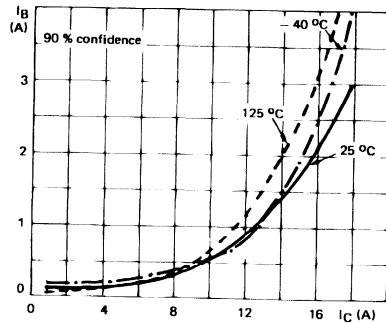

Base Characteristics.

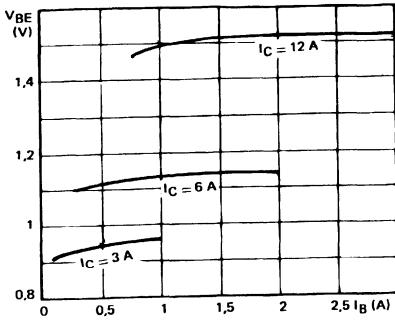

Collector Saturation Region.

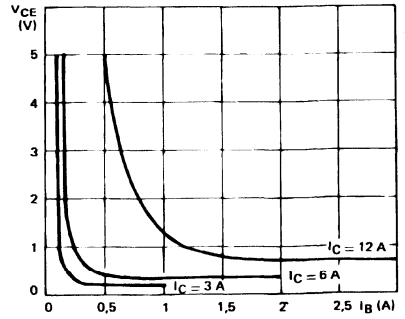

Saturation Voltage.

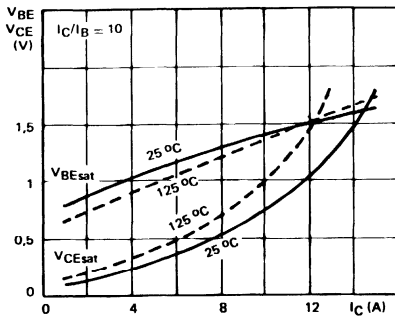

Collector Current Spread vs. Base-emitter Voltage.

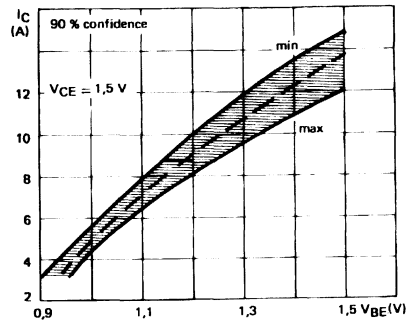

SWITCHING OPERATING AND OVERLOAD AREAS

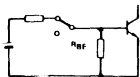

Transistor Forward Biased

- During the turn on
- During the turn off without negative base-emitter voltage and $R_{BE} \leq 100 \Omega$

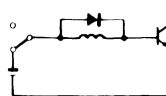

Transistor Reverse Biased

- During the turn off with negative base emitter voltage

Forward Biased Safe Operating Area (FBSOA).

Reverse Biased Safe Operating Area (RBSOA).

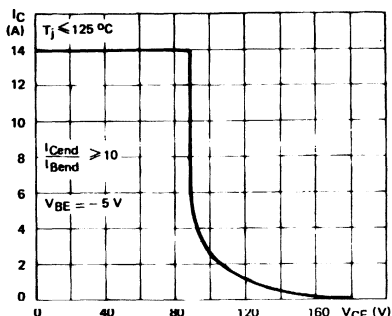
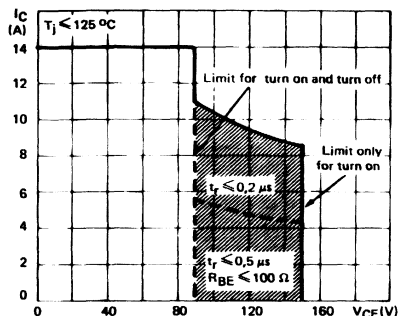

The hatched zone can only be used for turn on.

Forward Biased Accidental Overload Area (FBAOA).

Reverse Biased Accidental Overload Area (RBAOA).

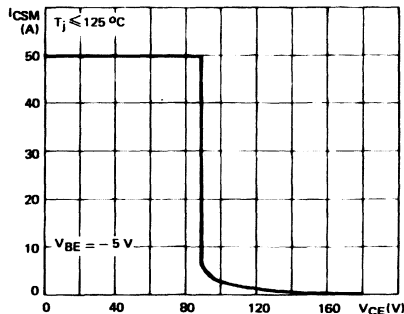
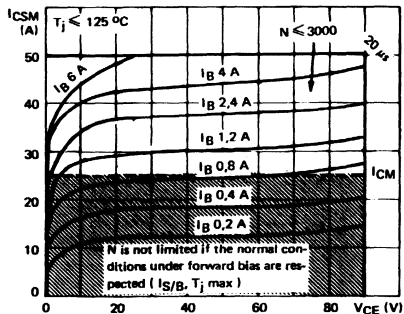

The Kellog network (heavy point) allows the calculation of the maximum value of the short-circuit current for a given base current I_B (90 % confidence).

After the accidental overload current, the RBAOA has to be used for the turn off.

High accidental surge currents ($I > I_{CM}$) are allowed if they are non repetitive and applied less than 3000 times during the component life.

Switching Times vs. Collector Current (resistive load).

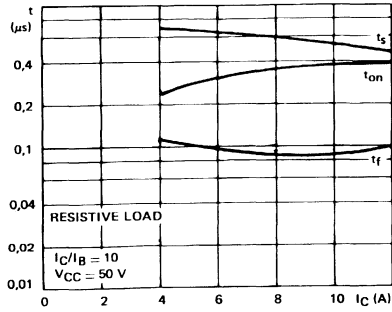

Switching Times vs. Junction Temperature.

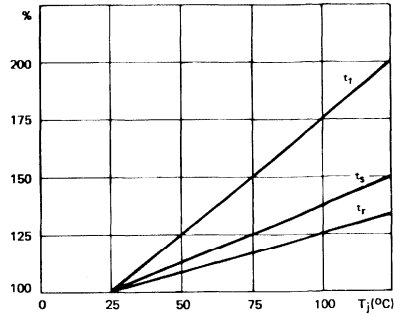

Switching Times Test Circuit on inductive load.

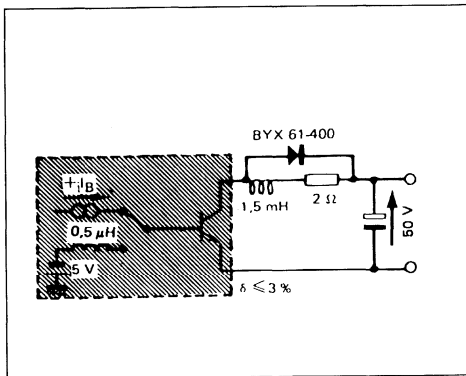

Switching Times vs. Collector Current.

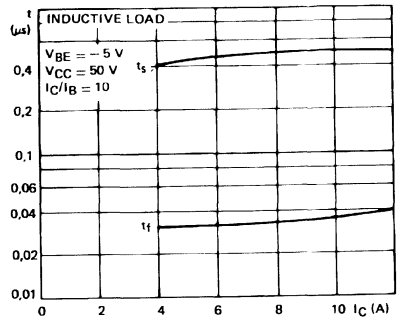

FAST NPN SWITCHING TRANSISTOR

- VERY LOW SATURATION VOLTAGE
- FAST TURN-OFF AND TURN-ON

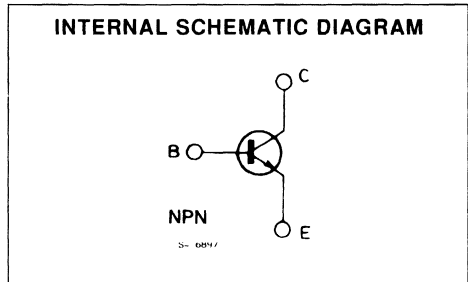
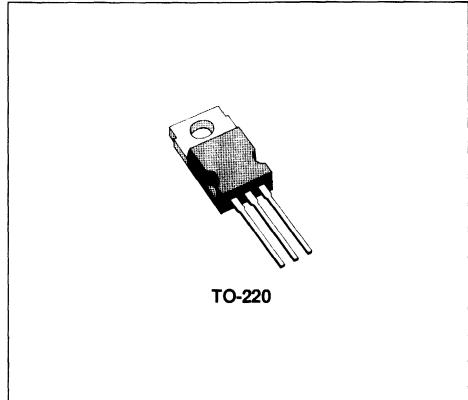
DESCRIPTION

High speed transistor suited for low voltage applications.

High frequency and efficiency converters switching regulators motor control.

ABSOLUTE MAXIMUM RATINGS

Symbol	Parameter	Value	Unit
V_{CBO}	Collector-base Voltage ($I_E = 0$)	240	V
V_{CEO}	Collector-emitter Voltage ($I_B = 0$)	120	V
V_{EBO}	Emitter-base Voltage ($I_C = 0$)	7	V
I_C	Collector Current	12	A
I_{CM}	Collector Peak Current	20	A
I_B	Base Current	4	A
I_{BM}	Base Peak Current	6	A
P_{tot}	Total Dissipation at $T_C < 25^\circ\text{C}$	85	W
P_{tot}	Total Dissipation at $T_C < 60^\circ\text{C}$	65	W
T_{stg}	Storage Temperature	- 65 to 175	$^\circ\text{C}$
T_j	Max. Operating Junction Temperature	175	$^\circ\text{C}$

THERMAL DATA

$R_{th(j-case)}$	Thermal Resistance Junction-case	max	1.76	$^{\circ}C/W$
------------------	----------------------------------	-----	------	---------------

ELECTRICAL CHARACTERISTICS ($T_{case} = 25^{\circ}C$ unless otherwise specified)

Symbol	Parameter	Test Conditions	Min.	Typ.	Max.	Unit.
I_{CER}	Collector Cutoff Current ($R_{BE} = 50\Omega$)	$V_{CE} = 240V$ $T_c = 125^{\circ}C$			3	mA
I_{CEX}	Collector Cutoff Current	$V_{CE} = 240V$ $V_{BE} = -1.5V$ $T_c = 125^{\circ}C$			1	mA
I_{EBO}	Emitter Cutoff Current ($I_C = 0$)	$V_{EB} = 5V$			1	mA
$V_{CEO(sus)}^*$	Collector Emitter Sustaining Voltage	$I_C = 0.2A$ $L = 25mH$	120			V
V_{EBO}	Emitter-base Voltage ($I_C = 0$)	$I_E = 50mA$	7		30	V
$V_{CE(sat)}^*$	Collector-emitter Saturation Voltage	$I_C = 4A$ $I_B = 0.4A$ $I_C = 8A$ $I_B = 0.8A$			0.7 1.5	V V
$V_{BE(sat)}^*$	Base-emitter Saturation Voltage	$I_C = 8A$ $I_B = 0.8A$			2	V

RESISTIVE LOAD

Symbol	Parameter	Test Conditions	Min.	Typ.	Max.	Unit.
t_{on}	Turn-on Time	$V_{CC} = 90V$ $I_C = 8A$		0.4	0.8	μs
t_s	Storage Time	$V_{BE} = -6V$ $I_{B1} = 0.8A$		0.5	1.2	μs
t_f	Fall Time	$R_{BB} = 3.75\Omega$		0.12	0.25	μs

INDUCTIVE LOAD

Symbol	Parameter	Test Conditions	Min.	Typ.	Max.	Unit.
t_s	Storage Time	$V_{CC} = 90V$ $I_C = 8A$		0.6		μs
t_f	Fall Time	$I_{B1} = 0.8A$ $V_{BE} = -5V$ $L_B = 1\mu H$		0.04		μs
t_s	Storage Time	$V_{CC} = 90V$ $I_C = 8A$			2	μs
t_f	Fall Time	$I_{B1} = 0.8A$ $V_{BE} = -5V$ $L_B = 1\mu H$ $T_j = 125^{\circ}C$			0.15	μs

Pulsed : Pulse duration = 300 μs , duty cycle = 2 %.

DC and Pulse Area.

Collector-emitter Voltage vs. Base-emitter Resistance.

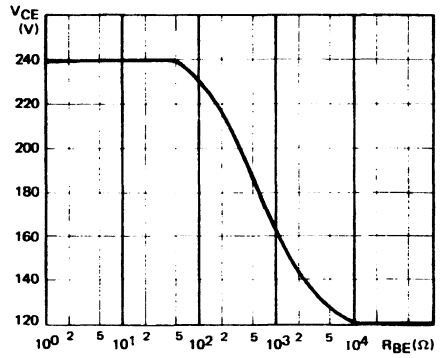
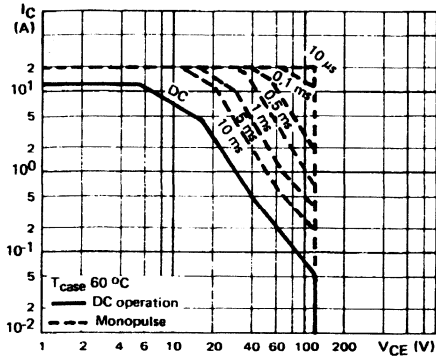

Power and $I_{S,B}$ Derating vs. Case Temperature.

Transient Thermal Response.

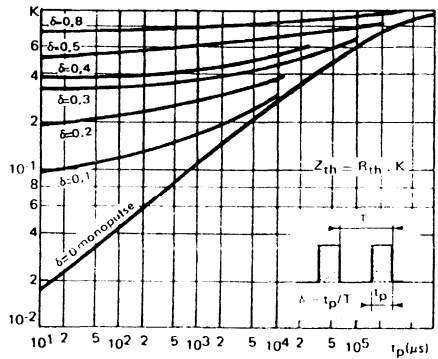
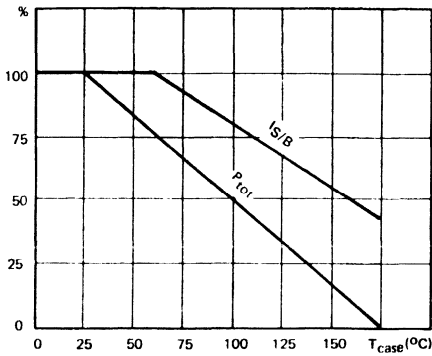

DC Current Gain.

Minimum Base Current to saturate the Transistor.

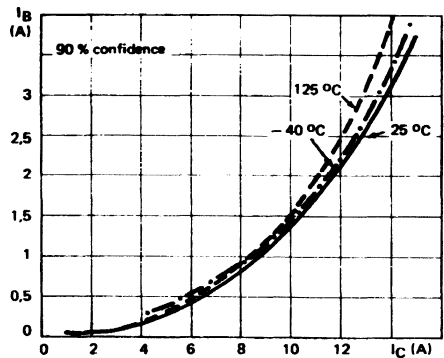
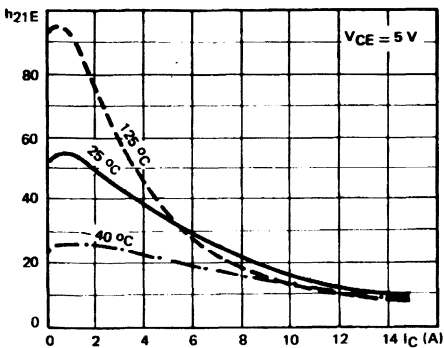

Base Characteristics.

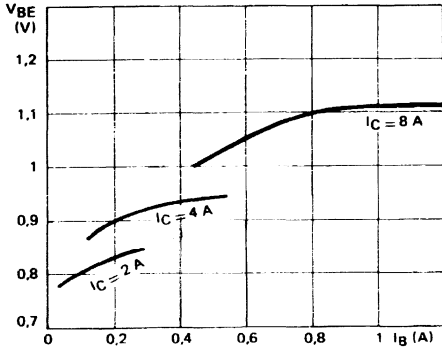

Collector Saturation Region.

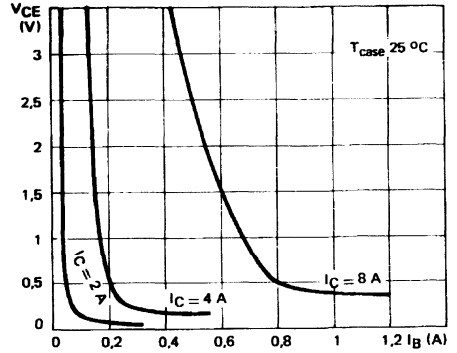

Saturation Voltage.

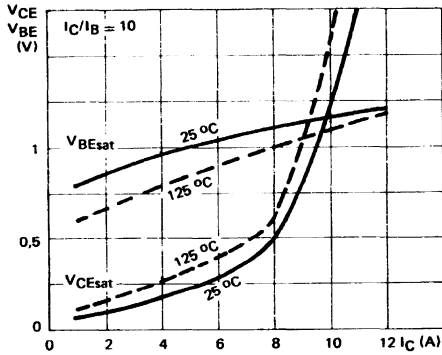

Collector Current Spread vs Base-emitter Voltage.

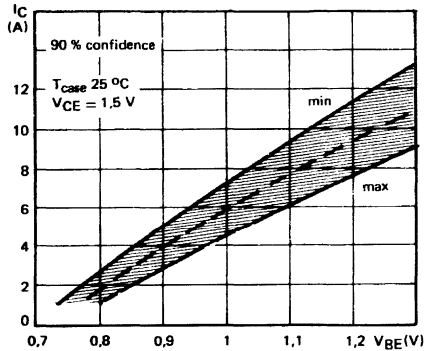

SWITCHING OPERATING AND OVERLOAD AREAS

Transistor Forward Biased
 - During the turn on
 - During the turn off without negative base-emitter voltage and $R_{BE} \geq 100\ \Omega$

Transistor Reverse Biased
 - During the turn off with negative base-Semitter voltage

Forward Biased Safe Operating Area (FBSOA).

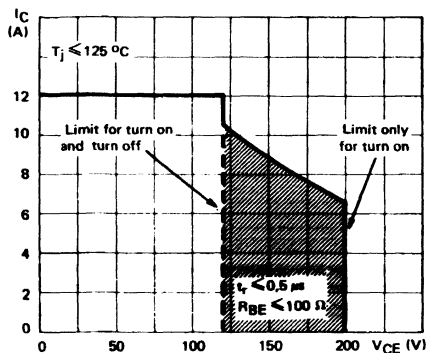

The hatched zone can only be used for turn on.

Forward Biased Accidental Overload Area (FBAOA).

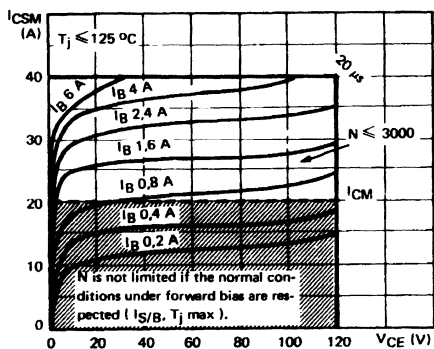

High accidental surge currents ($I > I_{CM}$) are allowed if they are non repetitive and applied less than 3000 times during the component life.

The Kellogg network (heavy point) allows the calculation of the maximum value of the short-circuit current for a given base current I_B (90 % confidence).

Reverse Biased Safe Operating Area (RBSOA).

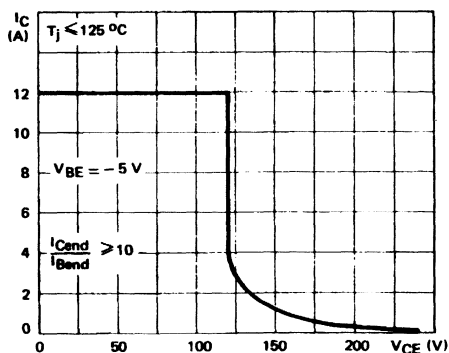

Reverse Biased Accidental Overload Area (RBAOA).

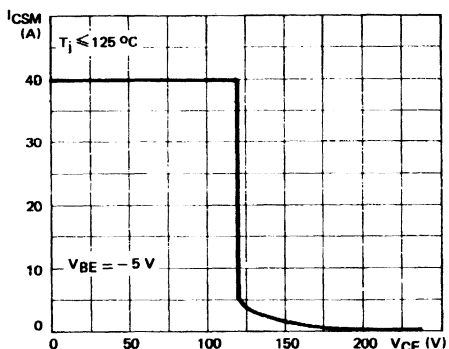

After the accidental overload current, the RBAOA has to be used for the turn off.

Switching Times vs Collector Current (resistive load).

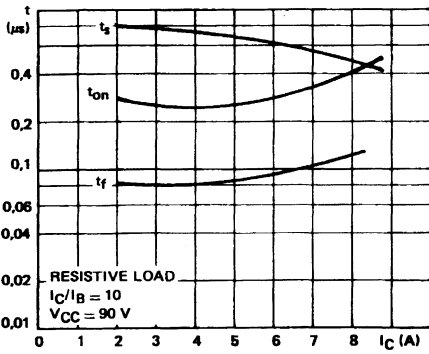

Switching Times vs Junction Temperature.

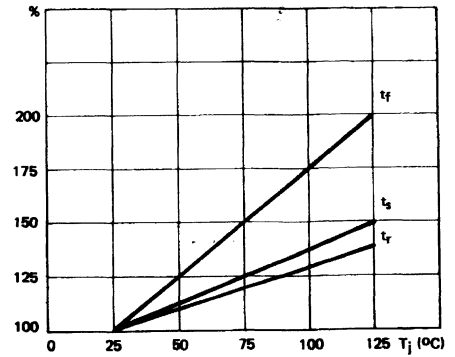

Switching Times Test Circuit on Inductive Load.

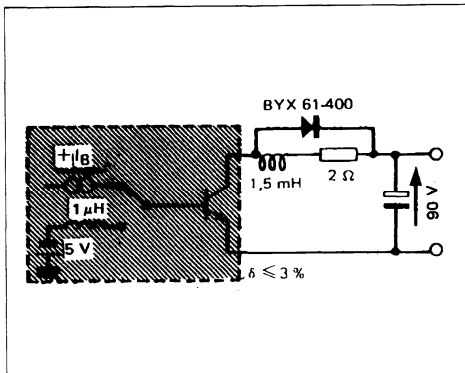

Switching Times vs Junction Temperature (inductive load).

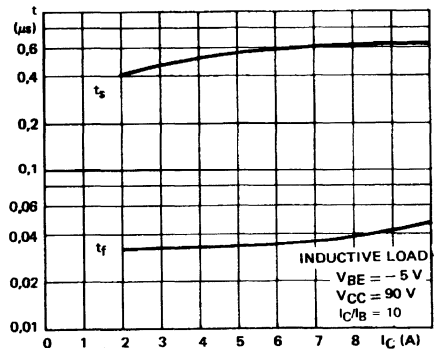

FAST NPN SWITCHING TRANSISTOR

- VERY LOW SATURATION VOLTAGE
- FAST TURN-OFF AND TURN-ON

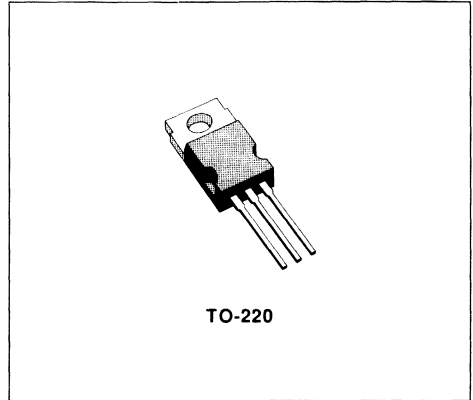

INTERNAL SCHEMATIC DIAGRAM

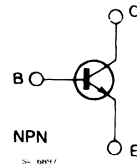

DESCRIPTION

High speed transistor suited for low voltage applications.

High frequency and efficiency converters switching regulators motor control.

ABSOLUTE MAXIMUM RATINGS

Symbol	Parameter	Value	Unit
V_{CBO}	Collector-base Voltage ($I_E = 0$)	400	V
V_{CEO}	Collector-emitter Voltage ($I_B = 0$)	200	V
V_{EBO}	Emitter-base Voltage ($I_C = 0$)	7	V
I_C	Collector Current	10	A
I_{CM}	Collector Peak Current	15	A
I_B	Base Current	2	A
I_{BM}	Base Peak Current	4	A
P_{tot}	Total Dissipation at $T_c < 25^\circ\text{C}$	85	W
P_{tot}	Total Dissipation at $T_c < 60^\circ\text{C}$	65	W
T_{stg}	Storage Temperature	- 65 to 175	$^\circ\text{C}$
T_j	Max. Operating Junction Temperature	175	$^\circ\text{C}$

THERMAL DATA

R _{thj-case}	Thermal Resistance Junction-case	Max	1.76	°C/W
-----------------------	----------------------------------	-----	------	------

ELECTRICAL CHARACTERISTICS (T_{case} = 25°C unless otherwise specified)

Symbol	Parameter	Test Conditions	Min.	Typ.	Max.	Unit	
I _{CER}	Collector Cutoff Current (R _{BE} = 50Ω)	V _{CE} = 400V T _C = 125°C			3	mA	
I _{CEx}	Collector Cutoff Current	V _{CE} = 400V V _{BE} = -1.5V T _C = 125°C			1	mA	
I _{EBO}	Emitter Cutoff Current (I _C = 0)	V _{EB} = 5V			1	mA	
V _{CEO(sus)} *	Collector Emitter Sustaining Voltage	I _C = 0.2A L = 25mH	200			V	
V _{EBO}	Emitter-base Voltage (I _C = 0)	I _E = 50mA	7		30	V	
V _{CE(sat)} *	Collector-emitter Saturation Voltage	I _C = 3A I _B = 0.3A I _C = 6A I _B = 0.6A			0.7 1.5	V	
V _{BE(sat)} *	Base-emitter Saturation Voltage	I _C = 6A I _B = 0.6A			2	V	
t _{on} t _s t _f	RESISTIVE LOAD Storage Time Fall Time Turn-on Time	V _{CC} = 150V V _{BE} = -6V R _{BB} = 5Ω	I _C = 6A I _{B1} = 0.6A		0.3 0.5 0.1	1 1.5 0.25	μs μs μs
t _s t _f	INDUCTIVE LOAD Storage Time Fall Time	V _{CC} = 150V I _{B1} = 0.6A L _B = 1μH	I _C = 6A V _{BE} = -5V		1 0.04		μs μs
t _s t _f	Storage Time Fall Time	V _{CC} = 150V I _{B1} = 0.6A L _B = 1μH	I _C = 6A V _{BE} = -5V T _J = 125°C			3 0.2	μs μs

* Pulsed : Pulse duration = 300μs, duty cycle = 2%.

DC and Pulse Area.

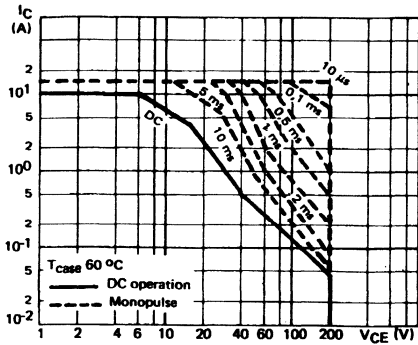

Collector-emitter Voltage vs. Base-emitter Resistance.

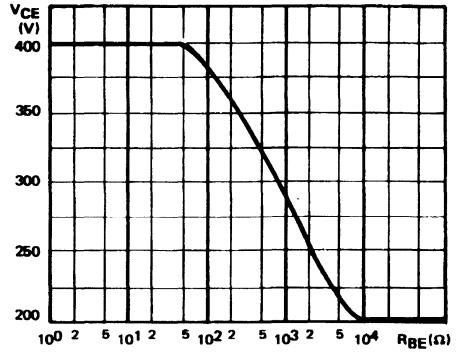

Power and I_S/I_B Derating vs. Case Temperature.

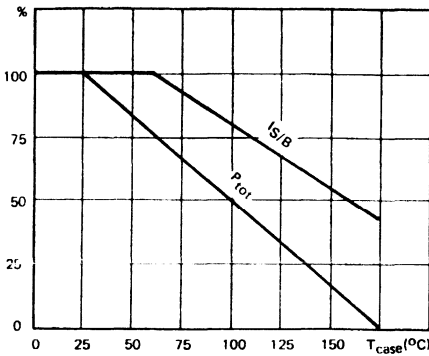

Transient Thermal Response.

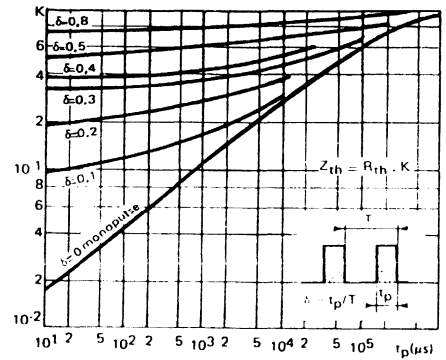

DC Current Gain.

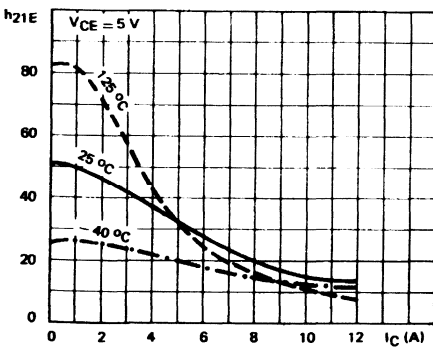

Minimum Base Current to saturate the Transistor.

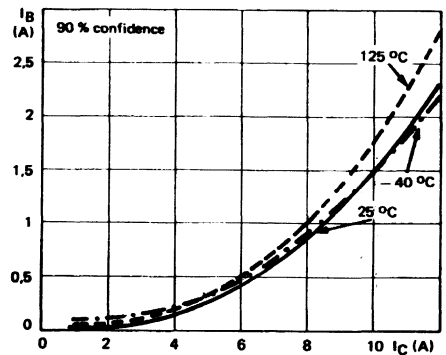

Base Characteristics.

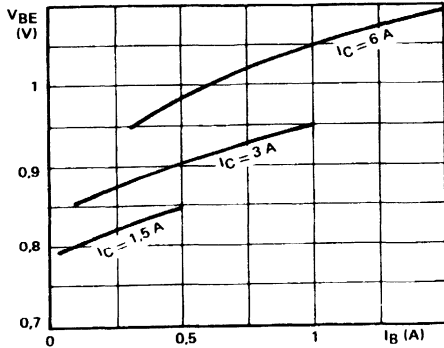

Collector Saturation Region.

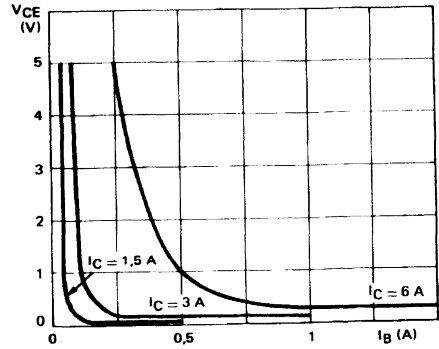

Saturation Voltage.

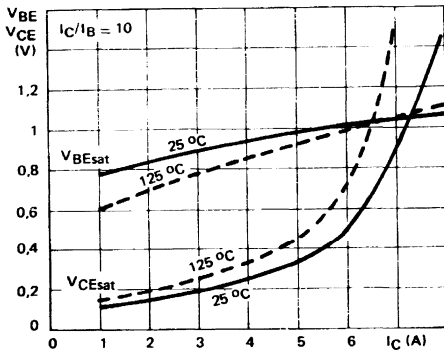

Collector Current Spread vs Base-emitter Voltage.

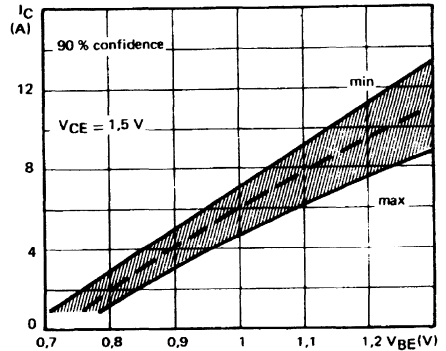

SWITCHING OPERATING AND OVERLOAD AREAS

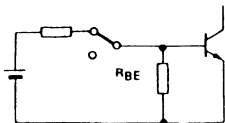

Transistor Forward Biased
 - During the turn on
 - During the turn off without negative base-emitter voltage and $R_{BE} \geq 100 \Omega$

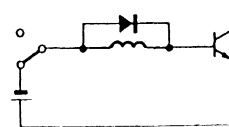

Transistor Reverse Biased
 - During the turn off with negative base emitter voltage

Forward Biased Safe Operating Area (FBSOA).

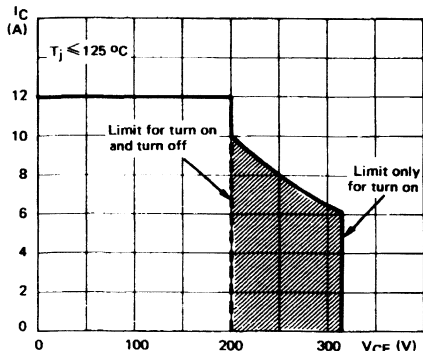

The hatched zone can only be used for turn on.

Forward Biased Accidental Overload Area (FBAOA).

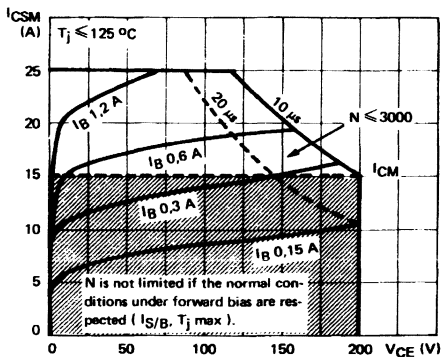

The Kellog network (heavy point) allows the calculation of the maximum value of the short-circuit current for a given base current I_B (90 % confidence).

High accidental surge currents ($I > I_{CM}$) are allowed if they are non repetitive and applied less than 3000 times during the component life.

Reverse Biased Safe Operating Area (RBSOA).

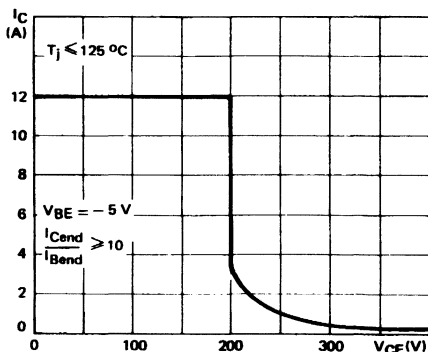

Reverse Biased Accidental Overload Area (RBAOA).

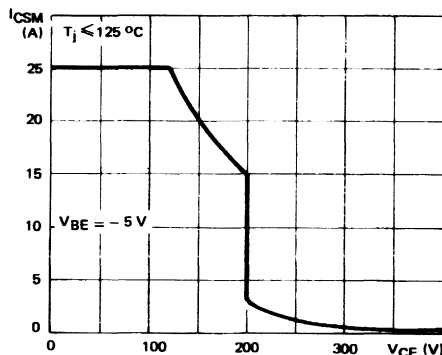

After the accidental overload current, the RBAOA has to be used for the turn off.

Switching Times vs Collector Current (resistive load).

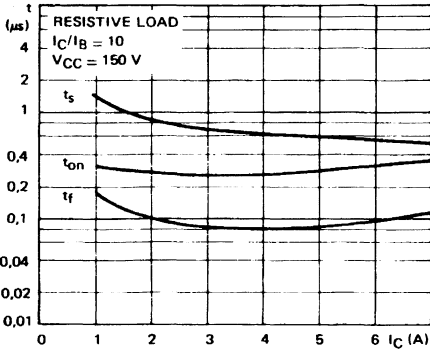

Switching Times vs Junction Temperature (resistive load).

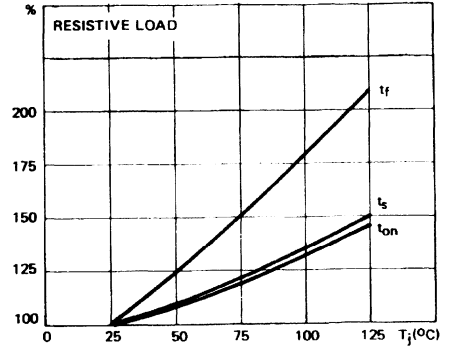

Switching Times Test Circuit on Inductive Load.

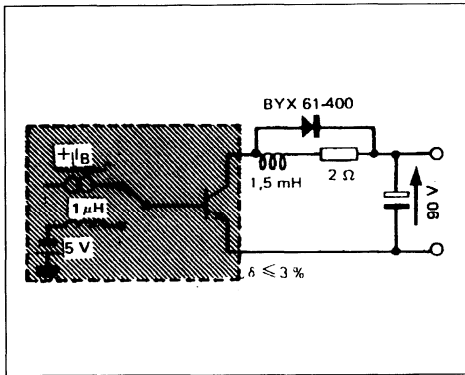

Switching Times vs Junction Temperature (inductive load).

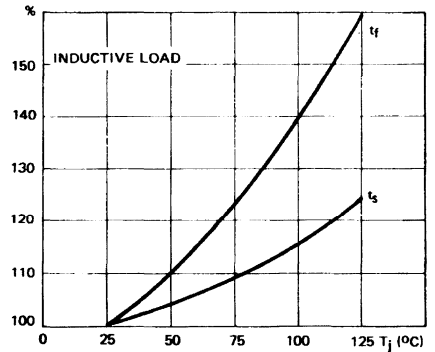

Switching Times vs Collector Current.

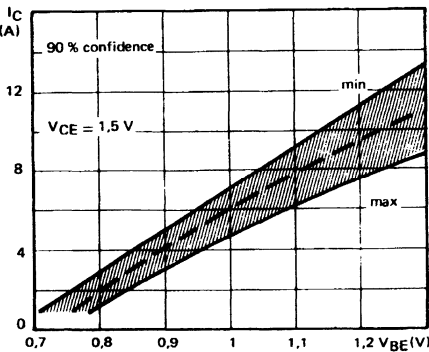

Fall Times vs applied Voltage Slope.

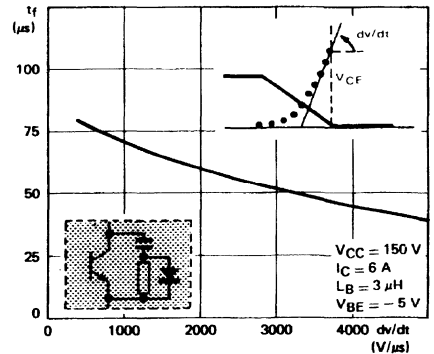

FAST SWITCHING POWER TRANSISTOR

- FAST SWITCHING TIMES
- LOW SWITCHING LOSSES
- VERY LOW SATURATION VOLTAGE AND HIGH GAIN FOR REDUCED LOAD OPERATION

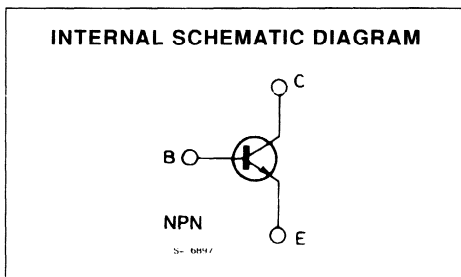
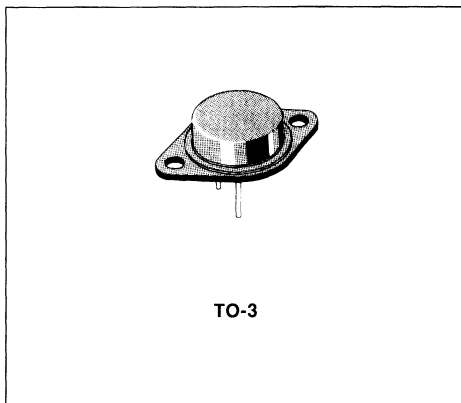

ABSOLUTE MAXIMUM RATINGS

Symbol	Parameter	Value	Unit
V_{CEV}	Collector-emitter Voltage ($V_{BE} = -1.5V$)	160	V
V_{CEO}	Collector-emitter Voltage ($I_B = 0$)	90	V
V_{EBO}	Emitter-base Voltage ($I_C = 0$)	7	V
I_C	Collector Current	25	A
I_{CM}	Collector Peak Current	45	A
I_B	Base Current	6	A
I_{BM}	Base Peak Current	9	A
P_{base}	Reverse Bias Base Dissipation (B.E. junction in avalanche)	1	W
P_{tot}	Total Dissipation at $T_c < 25^\circ C$	120	W
T_{stg}	Storage Temperature	- 65 to 200	$^\circ C$
T_j	Max. Operating Junction Temperature	200	$^\circ C$

THERMAL DATA

R _{thj-case}	Thermal Resistance Junction-case	Max	1.46	°C/W
-----------------------	----------------------------------	-----	------	------

ELECTRICAL CHARACTERISTICS (T_{case} = 25°C unless otherwise specified)

Symbol	Parameter	Test Conditions	Min.	Typ.	Max.	Unit.	
I _{CEr}	Collector Cutoff Current (R _{BE} = 10Ω)	V _{CE} = V _{CEV} V _{CE} = V _{CEV} T _c = 100°C			1 5	mA mA	
I _{CEV}	Collector Cutoff Current	V _{CE} = V _{CEV} V _{BE} = -1.5V V _{CE} = V _{CEV} V _{BE} = -1.5V T _c = 100°C			1 5	mA mA	
I _{EBO}	Emitter Cutoff Current (I _C = 0)	V _{EB} = 5V			1	mA	
V _{CEO(sus)} *	Collector Emitter Sustaining Voltage	I _C = 0.2A L = 25mH	90			V	
V _{EBO}	Emitter-base Voltage (I _C = 0)	I _E = 50mA	7			V	
V _{CE(sat)} *	Collector-emitter Saturation Voltage	I _C = 7.5A I _B = 0.375A I _C = 15A I _B = 1.5A I _C = 20A I _B = 2.5A I _C = 7.5A I _B = 0.375A T _J = 100°C I _C = 15A I _B = 1.5A T _J = 100°C I _C = 20A I _B = 2.5A T _J = 100°C		0.5 0.65 0.85 0.5 0.8 1.1	0.8 0.9 1.2 0.9 1.5 1.8	V V V V V V	
V _{BE(sat)} *	Base-emitter Saturation Voltage	I _C = 15A I _B = 1.5A I _C = 20A I _B = 2.5A I _C = 15A I _B = 1.5A T _J = 100°C I _C = 20A I _B = 2.5A T _J = 100°C		1.4 1.6 1.45 1.7	1.7 1.9 1.8 2.1	V V V V	
di _C /dt	Rated of Rise of on-state Collector Current	V _{CC} = 72V R _C = 0 See fig.2	I _{B1} = 2.25A T _J = 25°C T _J = 100°C	35 30	50 45	A/μs A/μs	
V _{CE(2μs)}	Collector Emitter Dynamic Voltage	V _{CC} = 72V R _C = 4.8Ω See fig.2	I _{B1} = 1.5A T _J = 25°C T _J = 100°C		1.7 2	2.5 4	V V
V _{CE(4μs)}	Collector Emitter Dynamic Voltage	V _{CC} = 72V R _C = 4.8Ω See fig.2	I _{B1} = 1.5A T _J = 25°C T _J = 100°C		1 1.5	2 3	V V

RESISTIVE LOAD

Symbol	Parameter	Test Conditions	Min.	Typ.	Max.	Unit
t _r	Rise Time	V _{CC} = 72V I _C = 20A		0.55	1.1	μs
t _s	Storage Time	V _{BB} = -5V I _{B1} = 2.5A		0.55	1	μs
t _f	Fall Time	R _{B2} = 1Ω t _p = 30μs See fig.1		0.12	0.25	μs

ELECTRICAL CHARACTERISTICS (continued)

INDUCTIVE LOAD

Symbol	Parameter	Test Conditions		Min.	Typ.	Max.	Unit
t_s	Storage Time	$V_{CC} = 72V$	$V_{clamp} = 90V$		0.75	1.2	μs
t_f	Fall Time	$I_C = 15A$	$I_B = 1.5A$		0.09	0.2	μs
t_t	Tail Time in Turn-on	$V_{BB} = -5V$	$R_{B2} = 1.7\Omega$		0.03	0.05	μs
t_c	Crossover Time	$L_C = 0.25mH$	See fig.3		0.14	0.3	μs
t_s	Storage Time	$V_{CC} = 72V$	$V_{clamp} = 90V$		0.95	1.7	μs
t_f	Fall Time	$I_C = 15A$	$I_B = 1.5A$		0.15	0.3	μs
t_t	Tail Time in Turn-on	$V_{BB} = -5V$	$R_{B2} = 1.7\Omega$		0.06	0.1	μs
t_c	Crossover Time	$L_C = 0.25mH$	$T_J = 100^\circ C$ See fig.3		0.3	0.5	μs
t_s	Storage Time	$V_{CC} = 72V$	$V_{clamp} = 90V$		1.4		μs
t_f	Fall Time	$I_C = 15A$	$I_B = 1.5A$		0.7		μs
t_t	Tail Time in Turn-on	$V_{BB} = 0$	$R_{B2} = 3.9\Omega$		0.22		μs
		$L_C = 0.25mH$	See fig.3				
t_s	Storage Time	$V_{CC} = 72V$	$V_{clamp} = 90V$		1.85		μs
t_f	Fall Time	$I_C = 15A$	$I_B = 1.5A$		1		μs
t_t	Tail Time in Turn-on	$V_{BB} = 0$	$R_{B2} = 3.9\Omega$		0.44		μs
		$L_C = 0.25mH$	$T_J = 100^\circ C$ See fig.3				

* Pulsed : Pulse duration = 300 μs , duty cycle = 2%.

Figure 1 : Switching Times Test Circuit (resistive load).

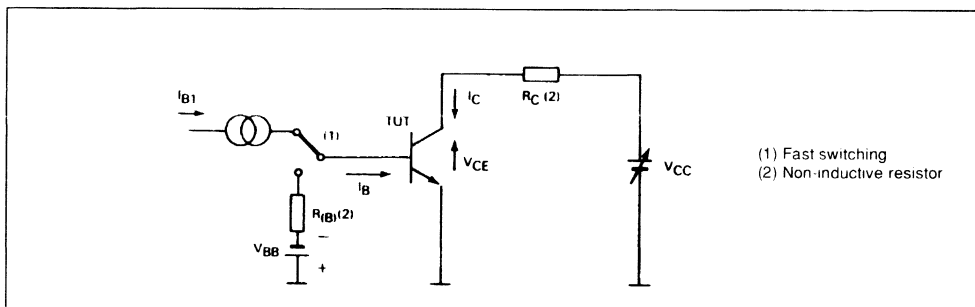

Figure 2 : Turn-on Switching Waveforms.

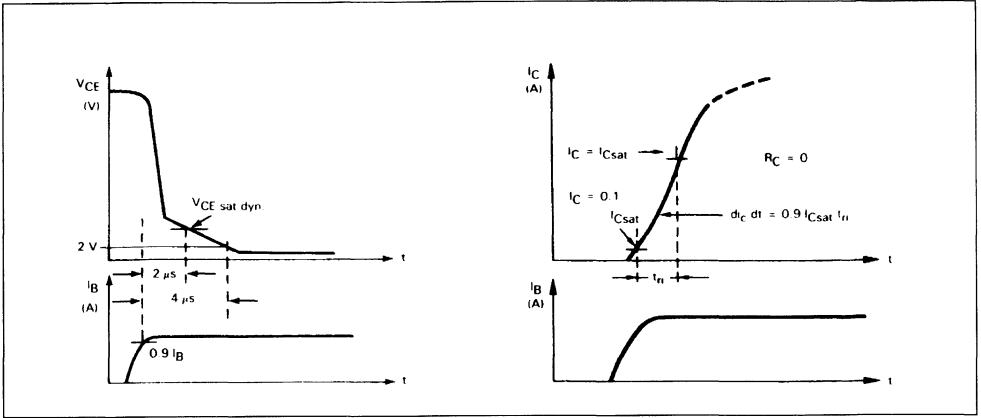

Figure 3a : Turn-off Switching Test Circuit.

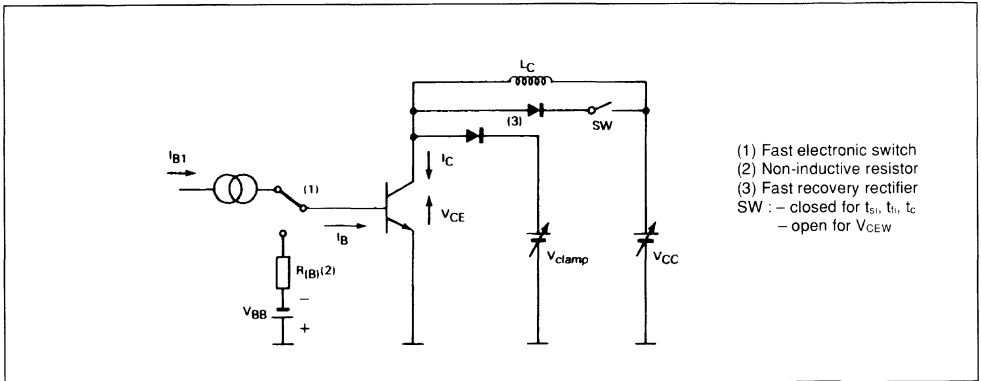
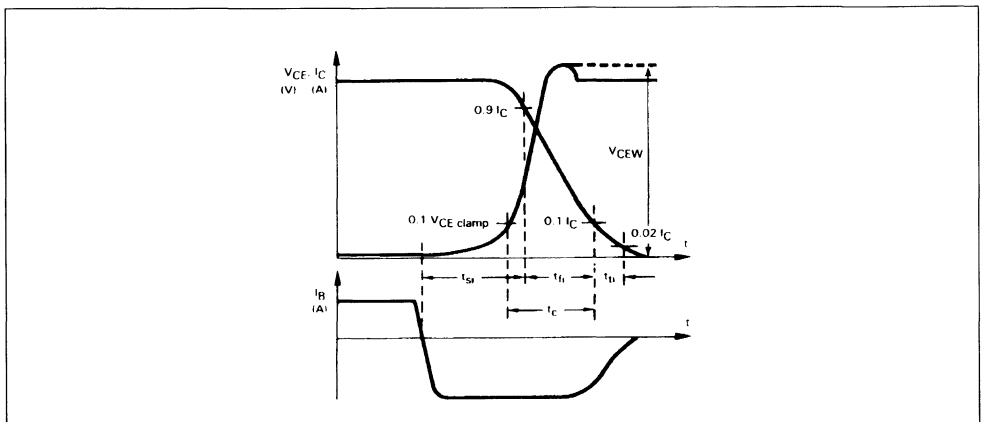
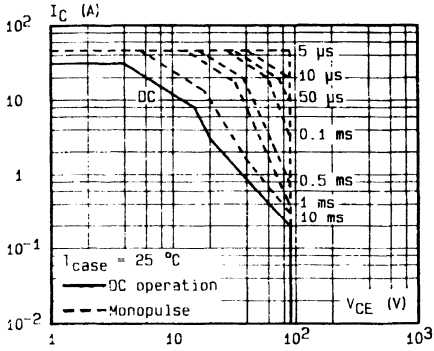

Figure 3b : Turn-off Switching Waveforms (inductive load).



DC and AC Pulse Area.



Power and $I_{S/B}$ Derating versus Case Temperature.

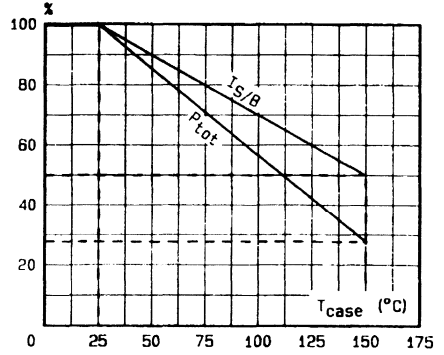

Transient Thermal Response.

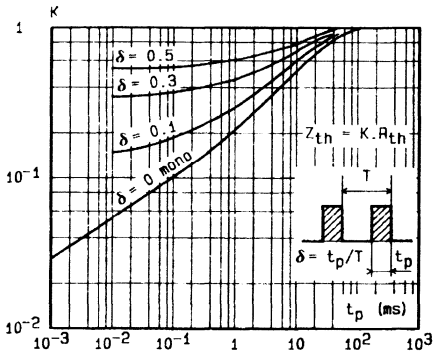

Collector-emitter Voltage versus Base-emitter Resistance.

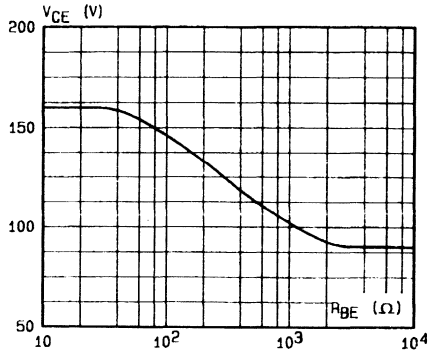

DC Current Gain.

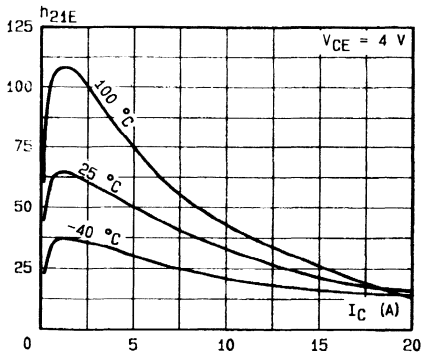

Minimum Base Current to saturate the transistor.

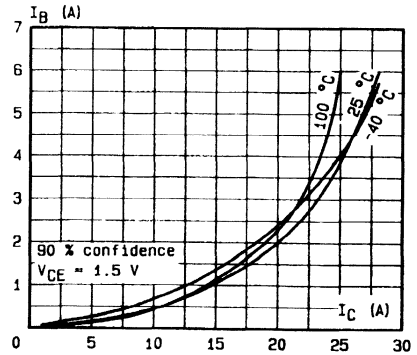

Saturation Voltage.

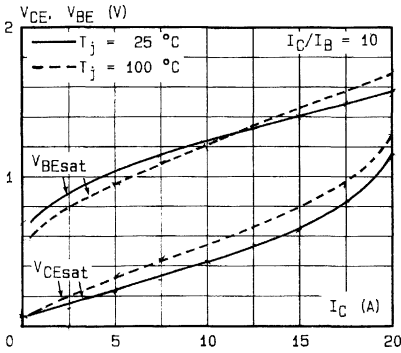

Saturation Voltage.

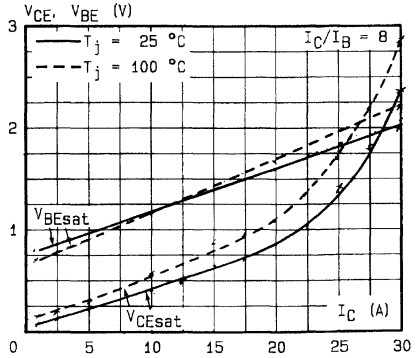

Switching Times versus Collector Current (resistive load).

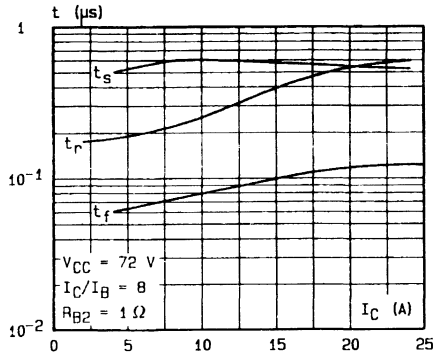

Switching Times versus Collector Current (inductive load).

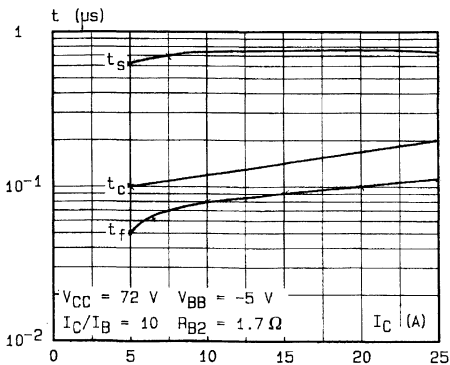

Switching Times versus Collector Current (inductive load).

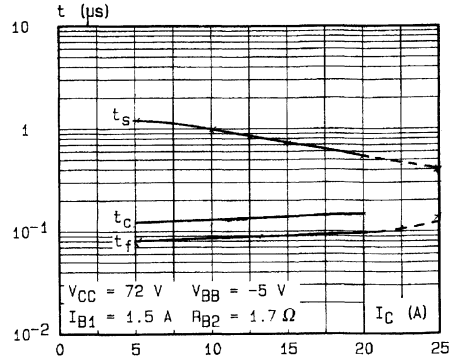

SWITCHING OPERATING AND OVERLOAD AREAS

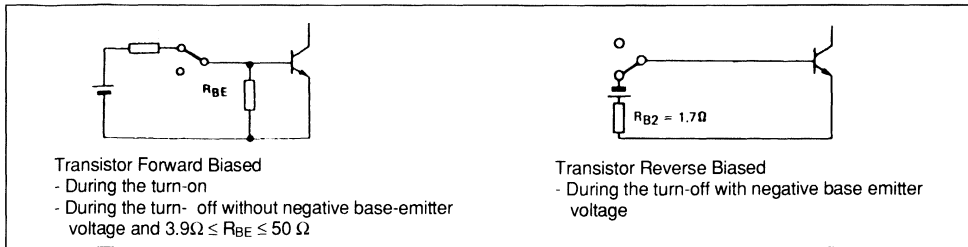

Forward Biased Safe Operating Area (FBSOA).

Reverse Biased Safe Operating Area (RBSOA).

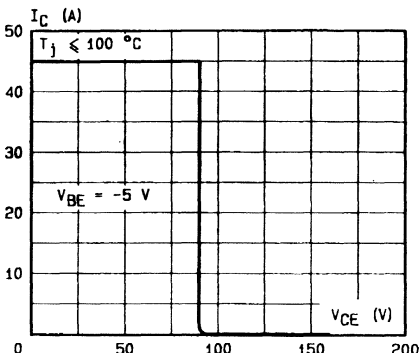
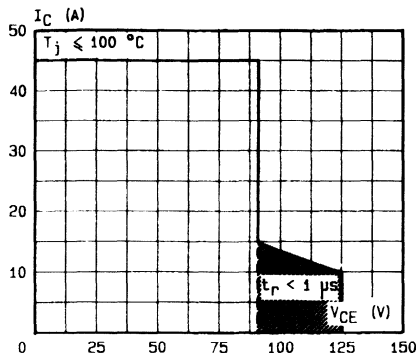

The hatched zone can only be used for turn-on

Forward Biased Accidental Overload Area (FBAOA).

Reverse Biased Accidental Overload Area (RBAOA).

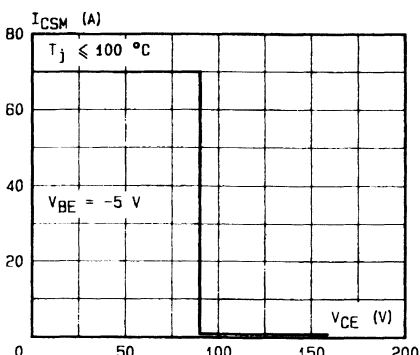
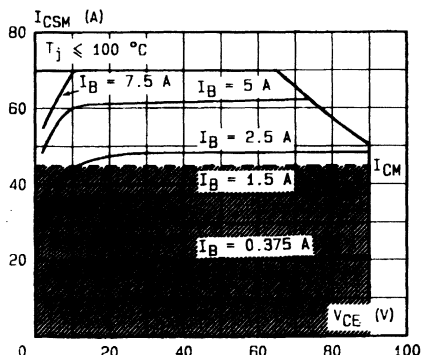

The Kellog network (heavy point) allows the calculation of the maximum value of the short-circuit for a given base current I_B (90 % confidence).

After the accidental overload current the RBAOA has to be used for the turn-off.

High accidental surge currents (I_{CM}) are allowed if they are non repetitive and applied less than 3000 times during the component life.

FAST SWITCHING POWER TRANSISTOR

- FAST SWITCHING TIMES
- LOW SWITCHING LOSSES
- VERY LOW SATURATION VOLTAGE AND HIGH GAIN FOR REDUCED LOAD OPERATION

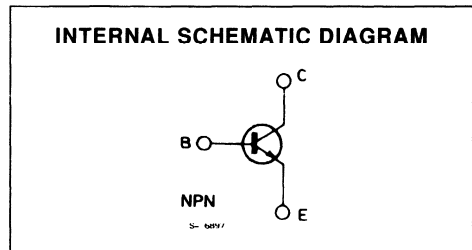
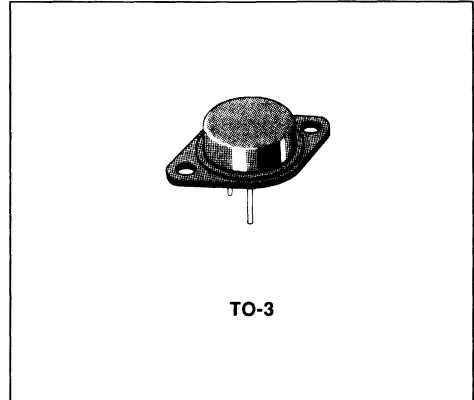
ABSOLUTE MAXIMUM RATINGS

Symbol	Parameter	Value	Unit
V_{CEV}	Collector-emitter Voltage ($V_{BE} = -1.5$ V)	250	V
V_{CEO}	Collector-emitter Voltage ($I_B = 0$)	125	V
V_{EBO}	Emitter-base Voltage ($I_C = 0$)	7	V
I_C	Collector Current	20	A
I_{CM}	Collector Peak Current	30	A
I_B	Base Current	4	A
I_{BM}	Base Peak Current	6	A
P_{base}	Reverse Bias Base Dissipation (B.E. junction in avalanche)	1	W
P_{tot}	Total Dissipation at $T_c < 25^\circ\text{C}$	120	W
T_{stg}	Storage Temperature	- 65 to 200	$^\circ\text{C}$
T_j	Max. Operating Junction Temperature	200	$^\circ\text{C}$

THERMAL DATA

$R_{thj-case}$	Thermal Resistance Junction-case	max	1.46	°C/W
----------------	----------------------------------	-----	------	------

ELECTRICAL CHARACTERISTICS ($T_{case} = 25^{\circ}C$ unless otherwise specified)

Symbol	Parameter	Test Conditions	Min.	Typ.	Max.	Unit
I_{CER}	Collector Cutoff Current ($R_{BE} = 10\Omega$)	$V_{CE} = V_{CEV}$			1	mA
		$V_{CE} = V_{CEV} \quad T_c = 100^{\circ}C$			5	mA
I_{CEV}	Collector Cutoff Current	$V_{CE} = V_{CEV} \quad V_{BE} = -1.5V$			1	mA
		$V_{CE} = V_{CEV} \quad V_{BE} = -1.5V \quad T_c = 100^{\circ}C$			5	mA
I_{EBO}	Emitter Cutoff Current ($I_C = 0$)	$V_{EB} = 5V$			1	mA
$V_{CE0(sus)}^*$	Collector Emitter Sustaining Voltage	$I_C = 0.2A$ $L = 25mH$	125			V
V_{EBO}	Emitter-base Voltage ($I_C = 0$)	$I_E = 50mA$	7			V
$V_{CE(sat)}^*$	Collector-emitter Saturation Voltage	$I_C = 5.5A \quad I_B = 0.275A$		0.5	0.8	V
		$I_C = 11A \quad I_B = 1.1A$		0.65	0.9	V
		$I_C = 15A \quad I_B = 1.875A$		0.9	1.2	V
		$I_C = 5.5A \quad I_B = 0.275A \quad T_j = 100^{\circ}C$		0.5	0.9	V
		$I_C = 11A \quad I_B = 1.1A \quad T_j = 100^{\circ}C$		0.8	1.2	V
		$I_C = 15A \quad I_B = 1.875A \quad T_j = 100^{\circ}C$		1.1	1.8	V
$V_{BE(sat)}^*$	Base-emitter Saturation Voltage	$I_C = 11A \quad I_B = 1.1A$		1.3	1.6	V
		$I_C = 15A \quad I_B = 1.875A$		1.5	1.9	V
		$I_C = 11A \quad I_B = 1.1A \quad T_j = 100^{\circ}C$		1.35	1.7	V
		$I_C = 15A \quad I_B = 1.875A \quad T_j = 100^{\circ}C$		1.6	2	V
di_C/dt	Rated of Rise of on-state Collector Current	$V_{CC} = 100V \quad R_C = 0 \quad I_{B1} = 1.65A$				
		See fig. 2	$T_j = 25^{\circ}C$ $T_j = 100^{\circ}C$	35 30	45 40	$A/\mu s$ $A/\mu s$
$V_{CE(2\mu s)}$	Collector Emitter Dynamic Voltage	$V_{CC} = 100V$				
		$R_C = 9\Omega$ See fig. 2	$I_{B1} = 1.1A$ $T_j = 25^{\circ}C$ $T_j = 100^{\circ}C$		2 2.6	2.5 4
$V_{CE(4\mu s)}$	Collector Emitter Dynamic Voltage	$V_{CC} = 100V$				
		$R_C = 9\Omega$ See fig. 2	$I_{B1} = 1.1A$ $T_j = 25^{\circ}C$ $T_j = 100^{\circ}C$		1.1 1.6	2 2.5

RESISTIVE LOAD

Symbol	Parameter	Test Conditions	Min.	Typ.	Max.	Unit
t_r	Rise Time	$V_{CC} = 100V \quad I_C = 15A$		0.4	1	μs
t_s	Storage Time	$V_{BB} = -5V \quad I_{B1} = 1.8A$		0.6	1	μs
t_f	Fall Time	$R_{B2} = 1.3\Omega \quad t_p = 30\mu s$ See fig. 1		0.14	0.3	μs

ELECTRICAL CHARACTERISTICS (continued)

INDUCTIVE LOAD

Symbol	Parameter	Test Conditions		Min.	Typ.	Max.	Unit
t_s	Storage Time	$V_{CC} = 100V$	$V_{clamp} = 125V$		0.75	1.4	μs
t_f	Fall Time	$I_C = 11A$	$I_B = 1.1A$		0.08	0.2	μs
t_t	Tail Time in Turn-on	$V_{BB} = -5V$	$R_{B2} = 2.3\Omega$		0.02	0.05	μs
t_c	Crossover Time	$L_C = 0.25mH$	See fig. 3		0.15	0.3	μs
t_s	Storage Time	$V_{CC} = 100V$	$V_{clamp} = 125V$		0.95	1.7	μs
t_f	Fall Time	$I_C = 11A$	$I_B = 1.1A$		0.14	0.3	μs
t_t	Tail Time in Turn-on	$V_{BB} = -5V$	$R_{B2} = 2.3\Omega$		0.04	0.1	μs
t_c	Crossover Time	$L_C = 0.25mH$	$T_j = 100^\circ C$		0.3	0.5	μs
t_s	Storage Time	$V_{CC} = 100V$	$V_{clamp} = 125V$		1.8		μs
t_f	Fall Time	$I_C = 11A$	$I_B = 1.1A$		0.7		μs
t_t	Tail Time in Turn-on	$V_{BB} = 0$	$R_{B2} = 4.7\Omega$		0.2		μs
		$L_C = 0.25mH$	See fig. 3				
t_s	Storage Time	$V_{CC} = 100V$	$V_{clamp} = 125V$		2.5		μs
t_f	Fall Time	$I_C = 11A$	$I_B = 1.1A$		1		μs
t_t	Tail Time in Turn-on	$V_{BB} = 0$	$R_{B2} = 4.7\Omega$		0.4		μs
		$L_C = 0.25mH$	$T_j = 100^\circ C$				
		See fig. 3					

Pulsed : Pulse duration = 300 μs , duty cycle = 2%.

Figure 1 : Switching Times Test Circuit (resistive load).

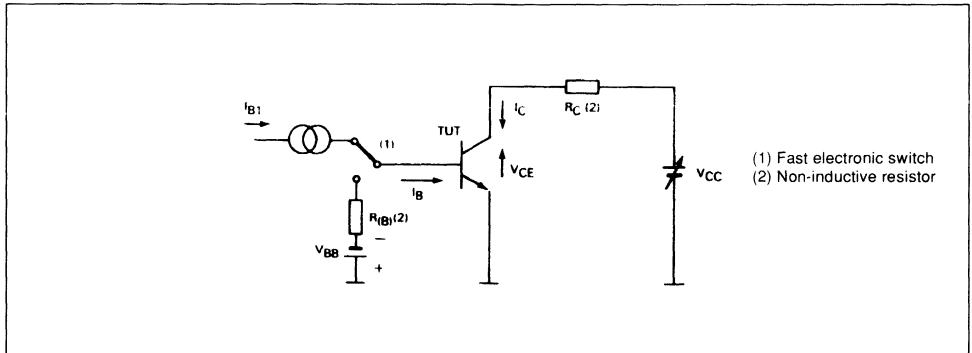

Figure 2 : Turn-on Switching Waveforms.

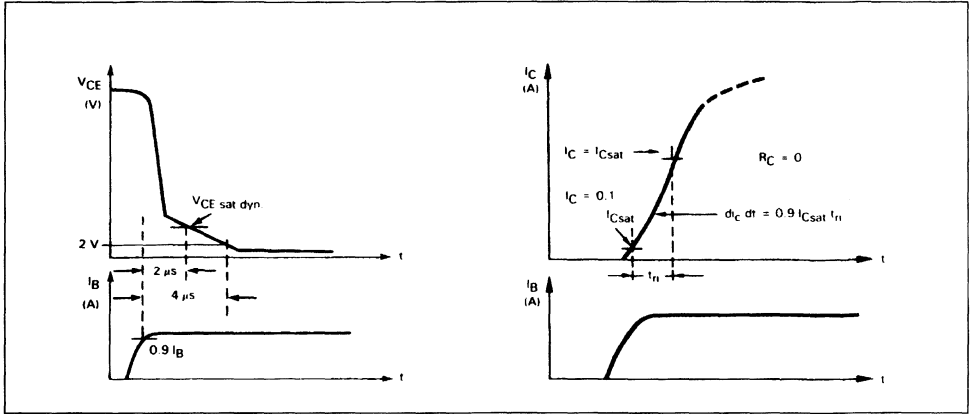

Figure 3a : Turn-off Switching Test Circuits.

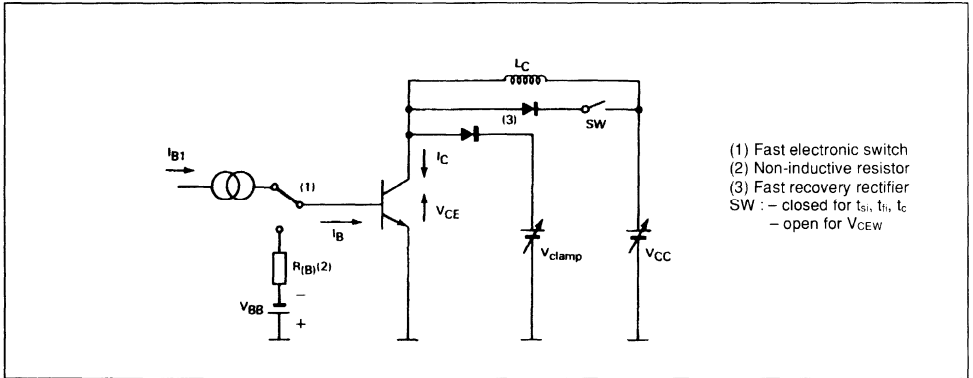
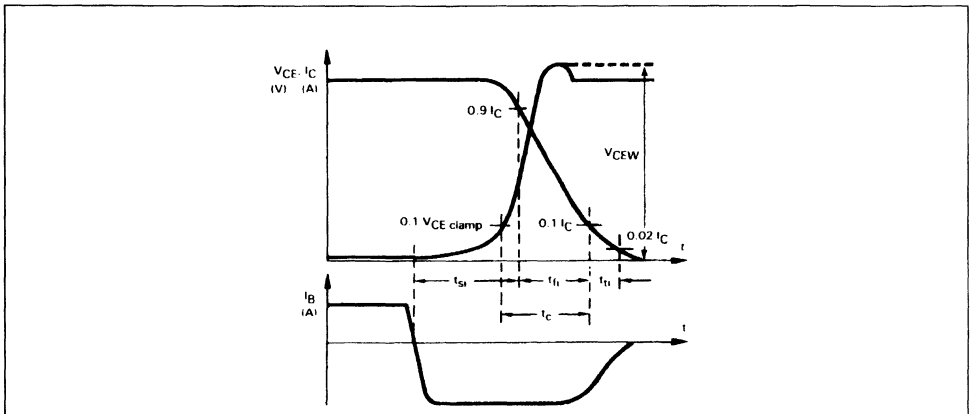
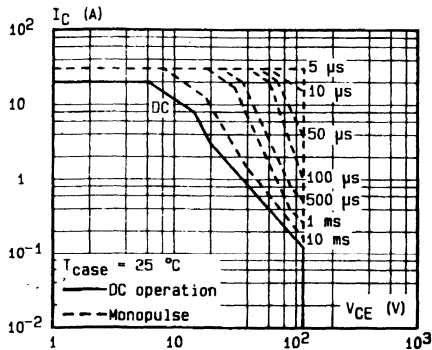

Figure 3b : Turn-off Switching Waveforms (inductive load).



DC and AC Pulse Area.



Power and $I_{S/B}$ Derating vs. Case Temperature.

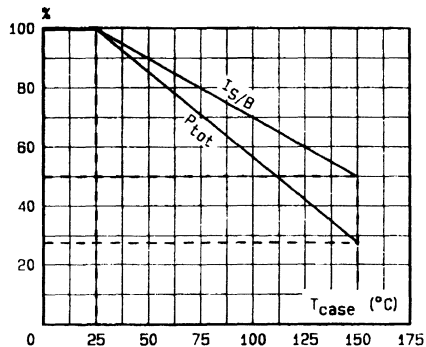

Transient Thermal Response.

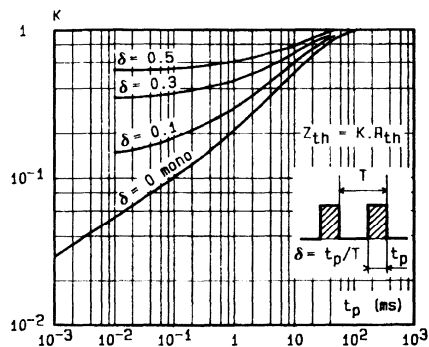

Collector-emitter Voltage vs. Base-emitter Resistance.

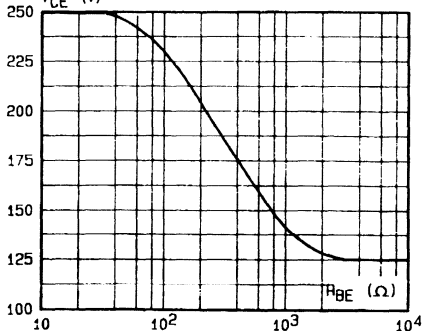

DC Current Gain.

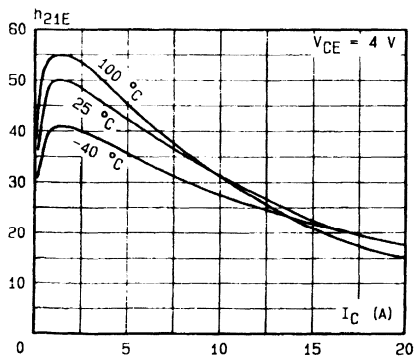

Minimum Base Current to saturate the Transistor.

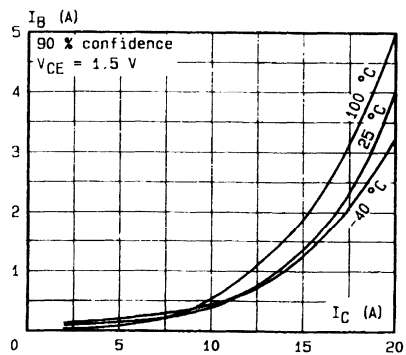

Saturation Voltage.

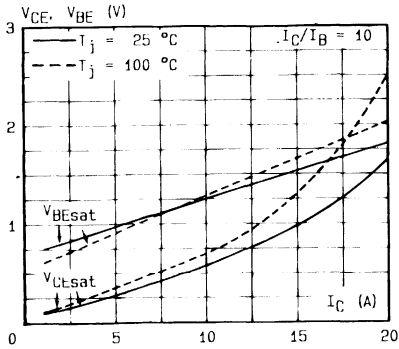

Saturation Voltage.

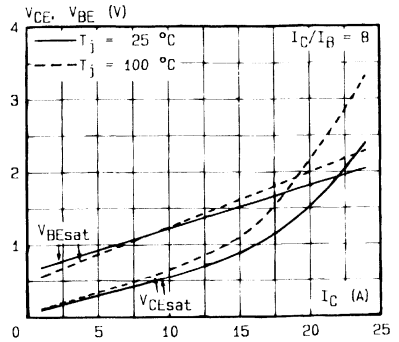

Switching Times versus Collector Current (resistive load).

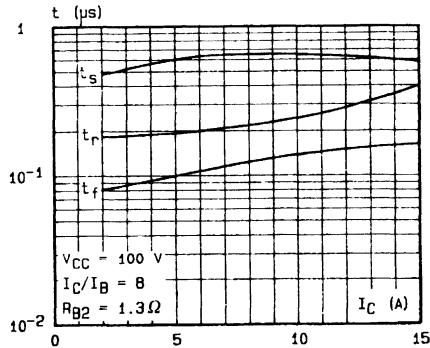

Switching Times versus Collector Current (inductive load).

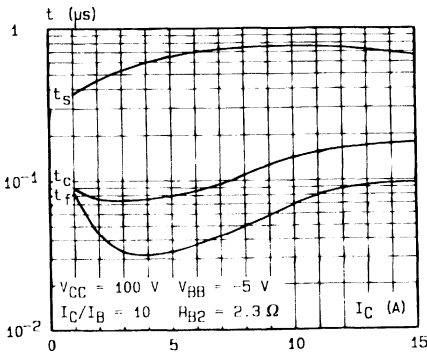

Switching Times versus Collector Current (inductive load).

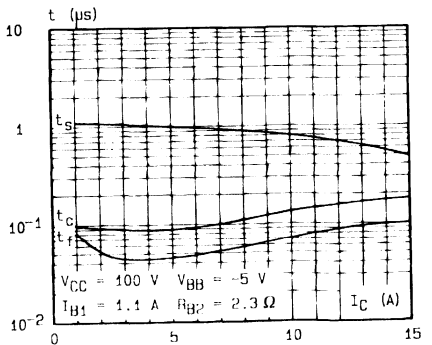

SWITCHING OPERATING AND OVERLOAD AREAS

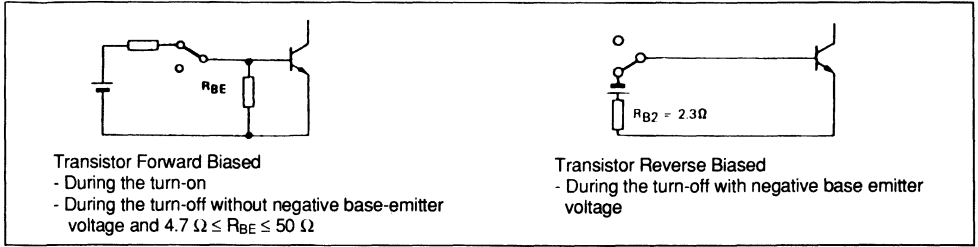

Forward Biased Safe Operating Area (FBSOA).

Reverse Biased Safe Operating Area (RBSOA).

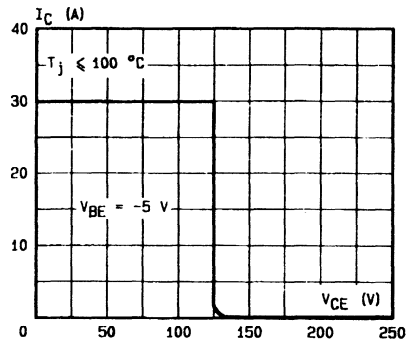
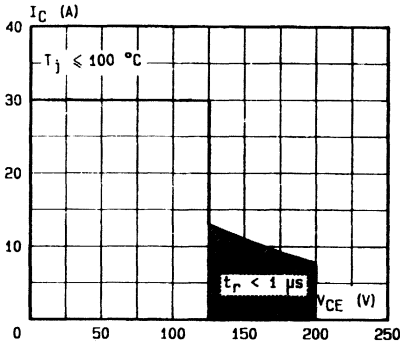

The hatched zone can only be used for turn-on.

Forward Biased Accidental Overload Area (FBAOA).

Reverse Biased Accidental Overload Area (RBAOA).

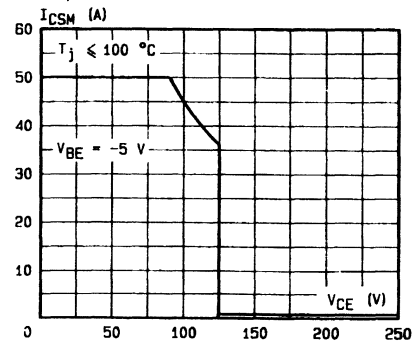
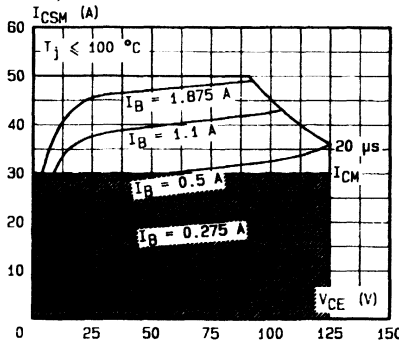

High accidental surge currents ($I > I_{CM}$) are allowed if they are non repetitive and applied less than 3000 times during the component life.

The Kellogg network (heavy point) allows the calculation of the maximum value of the short-circuit for a given base current I_B (90 % confidence).

After the accidental overload current the RBAOA has to be used for the turn-off

FAST SWITCHING POWER TRANSISTOR

- FAST SWITCHING TIMES
- LOW SWITCHING LOSSES
- VERY LOW SATURATION VOLTAGE AND HIGH GAIN FOR REDUCED LOAD OPERATION

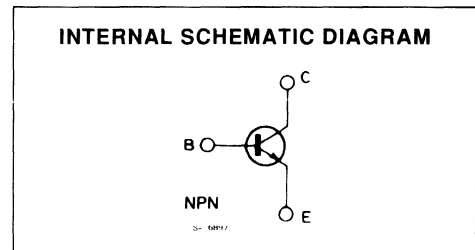
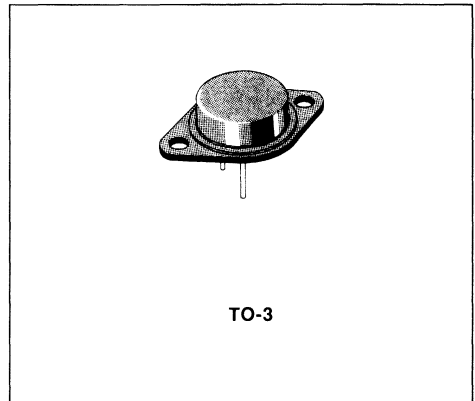

ABSOLUTE MAXIMUM RATINGS

Symbol	Parameter	Value	Unit
V_{CEV}	Collector-emitter Voltage ($V_{BE} = -1.5$ V)	300	V
V_{CEO}	Collector-emitter Voltage ($I_B = 0$)	200	V
V_{EBO}	Emitter-base Voltage ($I_C = 0$)	7	V
I_C	Collector Current	15	A
I_{CM}	Collector Peak Current	20	A
I_B	Base Current	3	A
I_{BM}	Base Peak Current	5	A
P_{base}	Reverse Bias Base Dissipation (B.E. junction in avalanche)	1	W
P_{tot}	Total Dissipation at $T_c < 25^\circ\text{C}$	120	W
T_{stg}	Storage Temperature	- 65 to 200	$^\circ\text{C}$
T_j	Max. Operating Junction Temperature	200	$^\circ\text{C}$

THERMAL DATA

$R_{thj-case}$	Thermal Resistance Junction-case	max	1.46	°C/W
----------------	----------------------------------	-----	------	------

ELECTRICAL CHARACTERISTICS ($T_{case} = 25^{\circ}C$ unless otherwise specified)

Symbol	Parameter	Test Conditions	Min.	Typ.	Max.	Unit.
I_{CER}	Collector Cutoff Current ($R_{BE} = 10\Omega$)	$V_{CE} = V_{CEV}$			0.5	mA
		$V_{CE} = V_{CEV} \quad T_c = 100^{\circ}C$			2.5	mA
I_{CEV}	Collector Cutoff Current	$V_{CE} = V_{CEV} \quad V_{BE} = -1.5V$			0.5	mA
		$V_{CE} = V_{CEV} \quad V_{BE} = -1.5V \quad T_c = 100^{\circ}C$			2	mA
I_{EBO}	Emitter Cutoff Current ($I_C = 0$)	$V_{EB} = 5V$			1	mA
$V_{CEO(sus)}$ *	Collector Emitter Sustaining Voltage	$I_C = 0.2A$ $L = 25mH$	200			V
V_{EBO}	Emitter-base Voltage ($I_C = 0$)	$I_E = 50mA$	7			V
$V_{CE(sat)}$ *	Collector-emitter Saturation Voltage	$I_C = 3A \quad I_B = 0.15A$		0.3	0.8	V
		$I_C = 6A \quad I_B = 0.6A$		0.45	0.9	V
		$I_C = 8A \quad I_B = 1A$		0.55	1.2	V
		$I_C = 3A \quad I_B = 0.15A \quad T_j = 100^{\circ}C$		0.3	0.9	V
		$I_C = 6A \quad I_B = 0.6A \quad T_j = 100^{\circ}C$		0.55	1.2	V
		$I_C = 8A \quad I_B = 1A \quad T_j = 100^{\circ}C$		0.65	1.5	V
$V_{BE(sat)}$ *	Base-emitter Saturation Voltage	$I_C = 6A \quad I_B = 0.6A$		1.15	1.6	V
		$I_C = 8A \quad I_B = 1A$		1.3	1.8	V
		$I_C = 6A \quad I_B = 0.6A \quad T_j = 100^{\circ}C$		1.15	1.6	V
		$I_C = 8A \quad I_B = 1A \quad T_j = 100^{\circ}C$		1.3	1.8	V
di_C/dt	Rated of Rise of on-state Collector Current	$V_{CC} = 160V \quad R_C = 0 \quad I_{B1} = 0.9A$				
		See fig. 2		30 25	33 28	
$V_{CE(2\mu s)}$	Collector Emitter Dynamic Voltage	$V_{CC} = 160V \quad I_{B1} = 0.6A$				
		$R_C = 27\Omega \quad T_j = 25^{\circ}C$ See fig. 2			1.05 1.53	2.5 4
$V_{CE(4\mu s)}$	Collector Emitter Dynamic Voltage	$V_{CC} = 160V \quad I_{B1} = 0.6A$				
		$R_C = 27\Omega \quad T_j = 25^{\circ}C$ See fig. 2			0.75 0.95	1.7 2

RESISTIVE LOAD

Symbol	Parameter	Test Conditions	Min.	Typ.	Max.	Unit
t_r	Rise Time	$V_{CC} = 160V \quad I_C = 8A$		0.3	0.5	μs
t_s	Storage Time	$V_{BB} = -5V \quad I_{B1} = 1A$		0.6	1.2	μs
t_f	Fall Time	$R_{B2} = 2.5\Omega \quad t_p = 30\mu s$ See fig. 1		0.12	0.3	μs

Pulsed : Pulse duration = 300 μs , duty cycle = 2%.

ELECTRICAL CHARACTERISTICS (continued)

INDUCTIVE LOAD

Symbol	Parameter	Test Conditions		Min.	Typ.	Max.	Unit
t_s	Storage Time	$V_{CC} = 160V$	$V_{clamp} = 200V$		0.75	1.5	μs
t_f	Fall Time	$I_C = 6A$	$I_B = 0.6A$		0.08	0.2	μs
t_t	Tail Time in Turn-on	$V_{BB} = -5V$	$R_{B2} = 4.2\Omega$		0.01	0.07	μs
t_c	Crossover Time	$L_C = 1.3mH$	See fig. 3		0.12	0.3	μs
t_s	Storage Time	$V_{CC} = 160V$	$V_{clamp} = 200V$		1.2	2	μs
t_f	Fall Time	$I_C = 6A$	$I_B = 0.6A$		0.12	0.3	μs
t_t	Tail Time in Turn-on	$V_{BB} = -5V$	$R_{B2} = 4.2\Omega$		0.03	0.15	μs
t_c	Crossover Time	$L_C = 1.3mH$	$T_j = 100^\circ C$		0.22	0.5	μs
t_s	Storage Time	$V_{CC} = 160V$	$V_{clamp} = 200V$		1.8		μs
t_f	Fall Time	$I_C = 6A$	$I_B = 0.6A$		0.45		μs
t_t	Tail Time in Turn-on	$V_{BB} = 0$	$R_{B2} = 6.8\Omega$		0.15		μs
		$L_C = 1.3mH$	See fig. 3				
t_s	Storage Time	$V_{CC} = 160V$	$V_{clamp} = 200V$		3.3		μs
t_f	Fall Time	$I_C = 6A$	$I_B = 0.6A$		0.8		μs
t_t	Tail Time in Turn-on	$V_{BB} = 0$	$R_{B2} = 6.8\Omega$		0.44		μs
		$L_C = 1.3mH$	$T_j = 100^\circ C$				
		See fig. 3					

Pulsed : Pulse duration = 300 μs , duty cycle = 2%.

Figure 1 : Switching Times Test Circuit (resistive load).

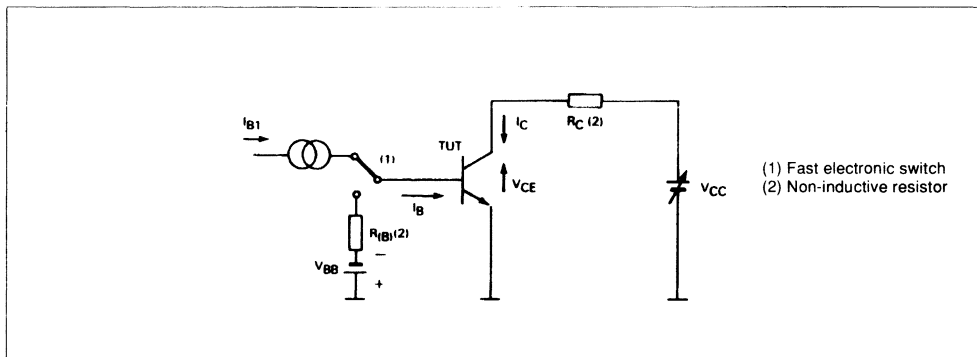

Figure 2 : Turn-on Switching Waveforms.

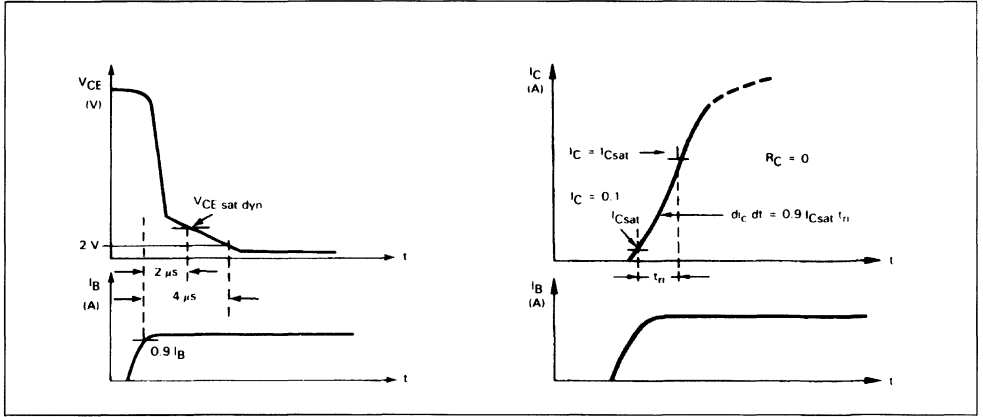

Figure 3a : Turn-off Switching Test Circuits.

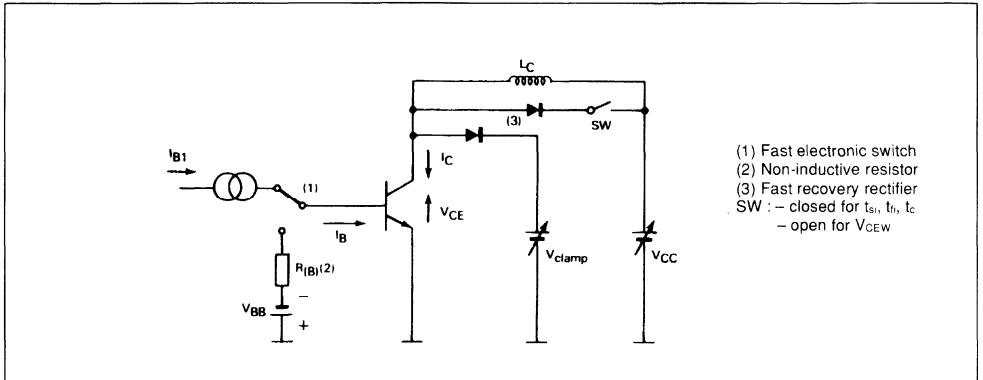
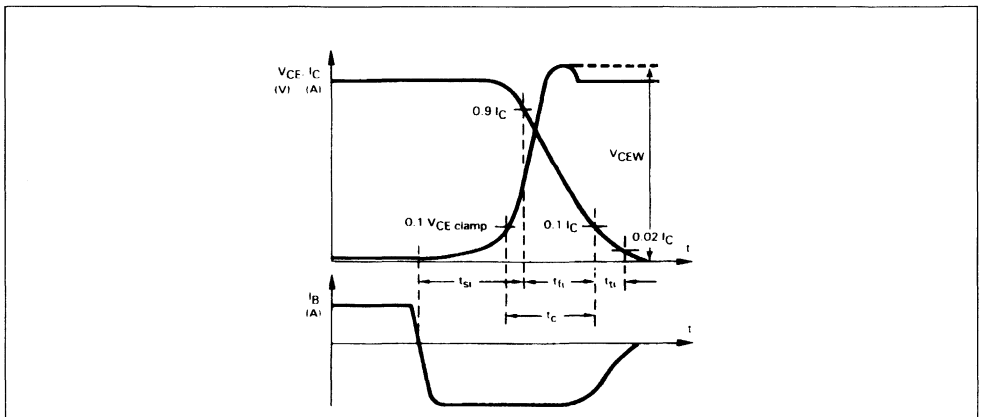
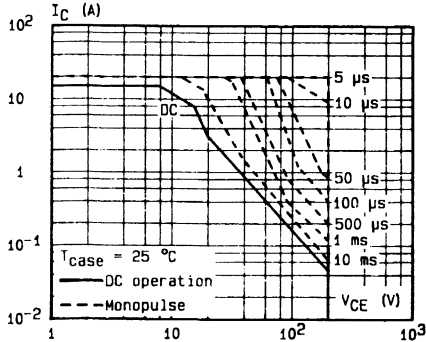

Figure 3b : Turn-off Switching Waveforms (inductive load).



DC and Pulse Area.



Power and $I_{S/B}$ Derating vs. Case Temperature.

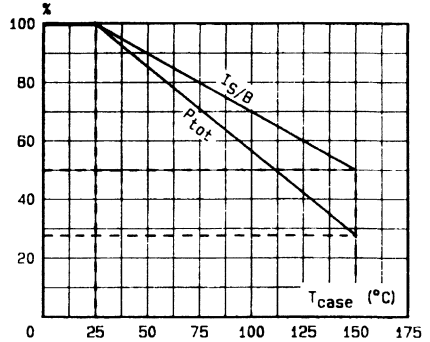

Transient Thermal Response.

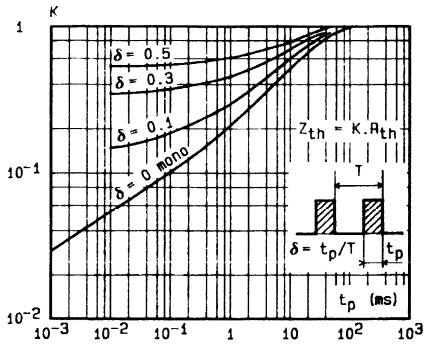

Collector-emitter Voltage vs. Base-emitter Resistance.

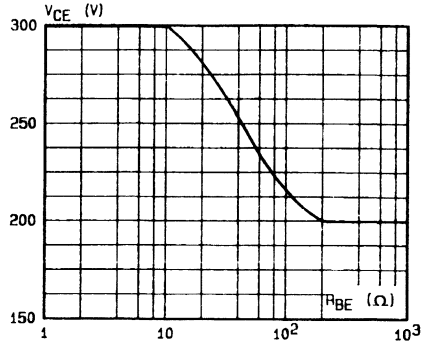

DC Current Gain.

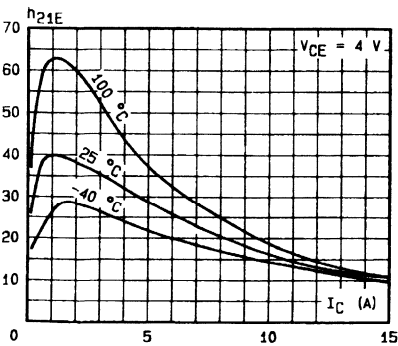

Minimum Base Current to saturate the Transistor.

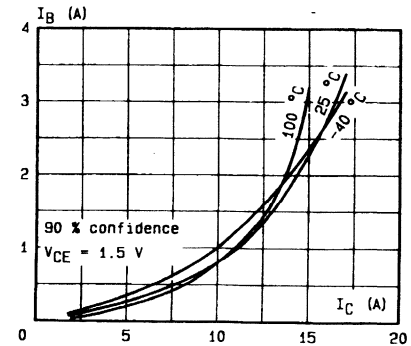

Saturation Voltage.

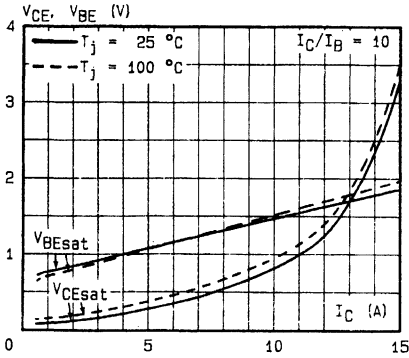

Saturation Voltage.

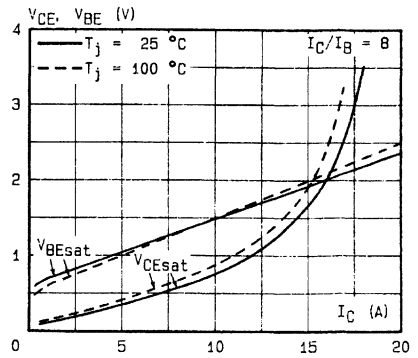

Switching Times versus Collector Current (resistive load).

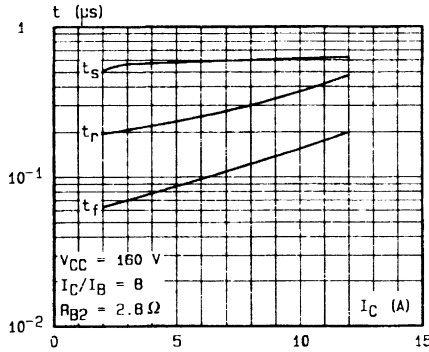

Switching Times versus Collector Current (inductive load).

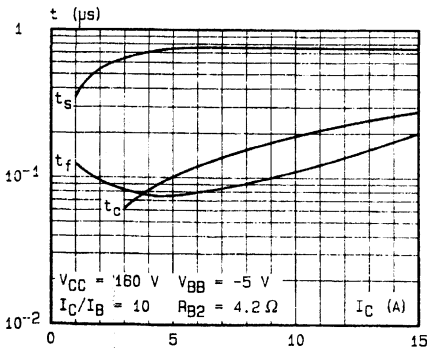

Switching Times versus Collector Current (inductive load).

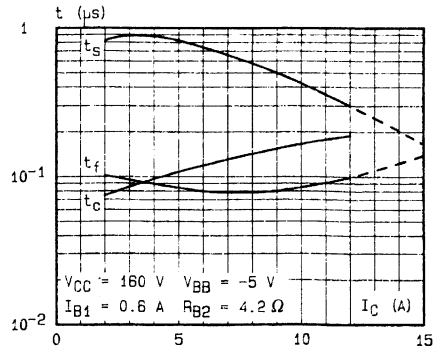

SWITCHING OPERATING AND OVERLOAD AREAS

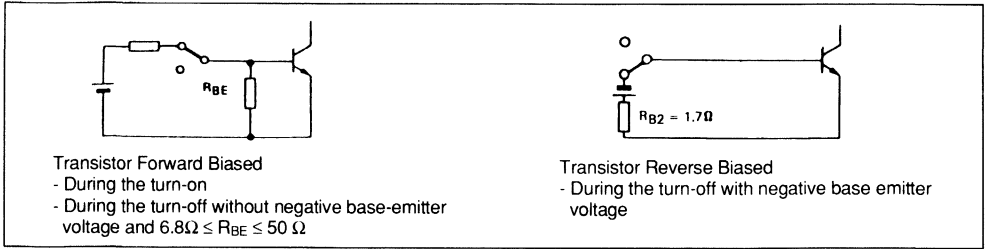

Forward Biased Safe Operating Area (FBSOA).

Reverse Biased Safe Operating Area (RBSOA).

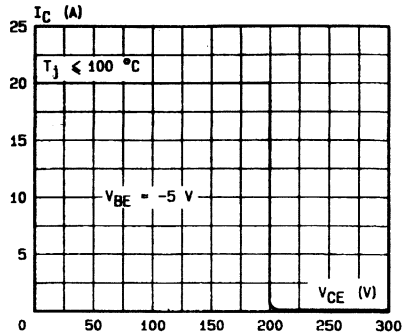
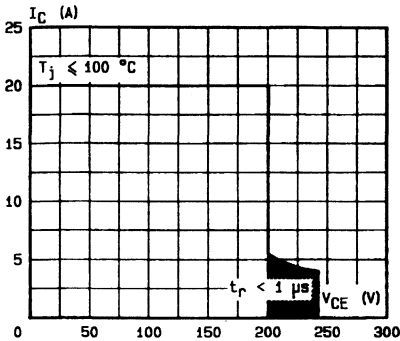

The hatched zone can only be used for turn-on

Forward Biased Accidental Overload Area (FBAOA).

Reverse Biased Accidental Overload Area (RBAOA).

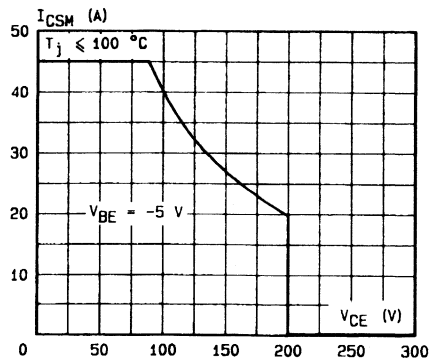
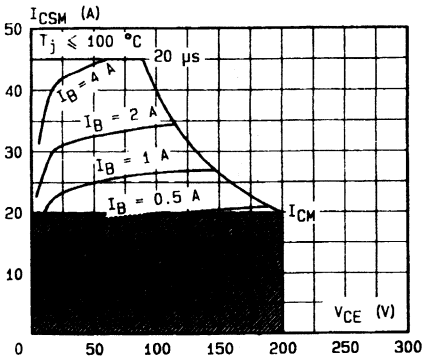

High accidental surge currents ($I > I_{CM}$) are allowed if they are non repetitive and applied less than 3000 times during the component life

The Kellog network (heavy point) allows the calculation of the maximum value of the short-circuit for a given base current I_B (90 % confidence).

After the accidental overload current the RBAOA has to be used for the turn-off

FAST SWITCHING POWER TRANSISTOR

- FAST SWITCHING TIMES
- LOW SWITCHING LOSSES
- VERY LOW SATURATION VOLTAGE AND HIGH GAIN FOR REDUCED LOAD OPERATION

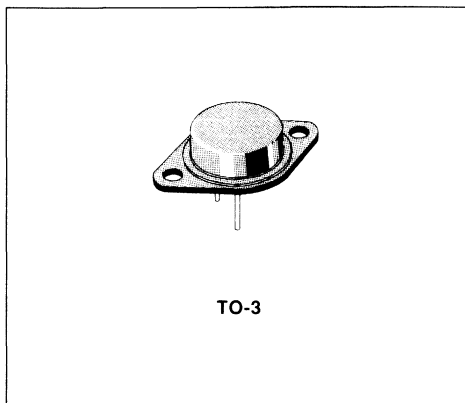

INTERNAL SCHEMATIC DIAGRAM

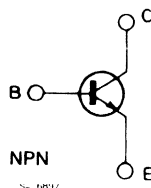

ABSOLUTE MAXIMUM RATINGS

Symbol	Parameter	Value	Unit
V_{CEV}	Collector-emitter Voltage ($V_{BE} = -1.5V$)	350	V
V_{CEO}	Collector-emitter Voltage ($I_B = 0$)	250	V
V_{EBO}	Emitter-base Voltage ($I_C = 0$)	7	V
I_C	Collector Current	12	A
I_{CM}	Collector Peak Current	18	A
I_B	Base Current	2.5	A
I_{BM}	Base Peak Current	4	A
P_{base}	Reverse Bias Base Dissipation (B. E. junction in avalanche)	1	W
P_{tot}	Total Dissipation at $T_c < 25^\circ C$	120	W
T_{stg}	Storage Temperature	- 65 to 200	$^\circ C$
T_J	Max. Operating Junction Temperature	200	$^\circ C$

THERMAL DATA

$R_{thj-case}$	Thermal Resistance Junction-case	Max	1.46	°C/W
----------------	----------------------------------	-----	------	------

ELECTRICAL CHARACTERISTICS ($T_{case} = 25^{\circ}C$ unless otherwise specified)

Symbol	Parameter	Test Conditions	Min.	Typ.	Max.	Unit	
I_{CER}	Collector Cutoff Current ($R_{BE} = 10\Omega$)	$V_{CE} = V_{CEV}$ $V_{CE} = V_{CEV}$ $T_c = 100^{\circ}C$			0.5 2.5	mA mA	
I_{CEV}	Collector Cutoff Current	$V_{CE} = V_{CEV}$ $V_{BE} = -1.5V$ $V_{CE} = V_{CEV}$ $V_{BE} = -1.5V$ $T_c = 100^{\circ}C$			0.5 2	mA mA	
I_{EBO}	Emitter Cutoff Current ($I_C = 0$)	$V_{EB} = 5V$			1	mA	
$V_{CEO(sus)}^*$	Collector Emitter Sustaining Voltage	$I_C = 0.2A$ $L = 25mH$	250			V	
V_{EBO}	Emitter-base Voltage ($I_C = 0$)	$I_E = 50mA$	7			V	
$V_{CE(sat)}^*$	Collector-emitter Saturation Voltage	$I_C = 2A$ $I_B = 0.13A$		0.25	0.8	V	
		$I_C = 4A$ $I_B = 0.4A$		0.4	0.9	V	
		$I_C = 6A$ $I_B = 0.75A$		0.5	1.2	V	
		$I_C = 2A$ $I_B = 0.13A$ $T_j = 100^{\circ}C$		0.25	0.9	V	
		$I_C = 4A$ $I_B = 0.4A$ $T_j = 100^{\circ}C$		0.45	1.2	V	
		$I_C = 6A$ $I_B = 0.75A$ $T_j = 100^{\circ}C$		0.6	1.5	V	
$V_{BE(sat)}^*$	Base-emitter Saturation Voltage	$I_C = 4A$ $I_B = 0.4A$		1	1.3	V	
		$I_C = 6A$ $I_B = 0.75A$		1.1	1.5	V	
		$I_C = 4A$ $I_B = 0.4A$ $T_j = 100^{\circ}C$		0.9	1.3	V	
		$I_C = 6A$ $I_B = 0.75A$ $T_j = 100^{\circ}C$		1.1	1.5	V	
di_c/dt	Rated of Rise of on-state Collector Current	$V_{CC} = 200V$ $R_C = 0$ $I_{B1} = 0.6A$		25	40	A/ μs A/ μs	
		See fig. 2 $T_j = 25^{\circ}C$ $T_j = 100^{\circ}C$		20	35		
$V_{CE} (2\mu s)$	Collector Emitter Dynamic Voltage	$V_{CC} = 200V$ $I_{B1} = 0.4A$			1.7	2.5	V
		$R_C = 50\Omega$ $T_j = 25^{\circ}C$ See fig. 2 $T_j = 100^{\circ}C$			2.5	4	V
$V_{CE} (4\mu s)$	Collector Emitter Dynamic Voltage	$V_{CC} = 200V$ $I_{B1} = 0.4A$			0.9	1.7	V
		$R_C = 50\Omega$ $T_j = 25^{\circ}C$ See fig. 2 $T_j = 100^{\circ}C$			1.1	2	V

RESISTIVE LOAD

Symbol	Parameter	Test Conditions	Min.	Typ.	Max.	Unit
t_r	Rise Time	$V_{CC} = 200V$ $I_C = 6A$		0.3	0.4	μs
t_s	Storage Time	$V_{BB} = -5V$ $I_{B1} = 0.75A$		1	1.6	μs
t_f	Fall Time	$R_{B2} = 3.3\Omega$ $t_p = 30\mu s$ See fig 1		0.15	0.3	μs

ELECTRICAL CHARACTERISTICS(continued)

INDUCTIVE LOAD

Symbol	Parameter	Test Conditions		Min.	Typ.	Max.	Unit
t_s	Storage Time	$V_{CC} = 200V$	$V_{clamp} = 250V$		1.2	1.8	μs
t_f	Fall Time	$I_C = 4A$	$I_B = 0.4A$		0.08	0.2	μs
t_t	Tail Time in Turn-on	$V_{BB} = -5V$	$R_{B2} = 6.3\Omega$		0.03	0.12	μs
t_c	Crossover Time	$L_C = 2.5mH$	See fig. 3		0.15	0.35	μs
t_s	Storage Time	$V_{CC} = 200V$	$V_{clamp} = 250V$		1.8	2.4	μs
t_f	Fall Time	$I_C = 4A$	$I_B = 0.4A$		0.2	0.4	μs
t_t	Tail Time in Turn-on	$V_{BB} = -5V$	$R_{B2} = 6.3\Omega$		0.08	0.2	μs
t_c	Crossover Time	$L_C = 2.5mH$	$T_j = 100^\circ C$		0.4	0.7	μs
t_s	Storage Time	$V_{CC} = 200V$	$V_{clamp} = 250V$		2.5		μs
t_f	Fall Time	$I_C = 4A$	$I_B = 0.5A$		0.4		μs
t_t	Tail Time in Turn-on	$V_{BB} = 0$	$R_{B2} = 7.5\Omega$		0.15		μs
		$L_C = 2.5mH$	See fig. 3				
t_s	Storage Time	$V_{CC} = 200V$	$V_{clamp} = 250V$		4.8		μs
t_f	Fall Time	$I_C = 4A$	$I_B = 0.4A$		0.7		μs
t_t	Tail Time in Turn-on	$V_{BB} = 0$	$R_{B2} = 7.5\Omega$		0.4		μs
		$L_C = 2.5mH$	$T_j = 100^\circ C$				
		See fig. 3					

* Pulsed : Pulse duration = 300 μs , duty cycle = 2 %.

Figure 1 : Switching Times Test Circuit (resistive load).

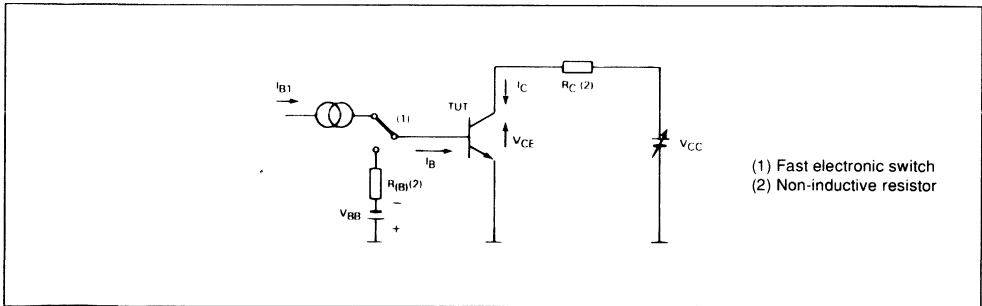

Figure 2 : Turn-on Switching Waveforms.

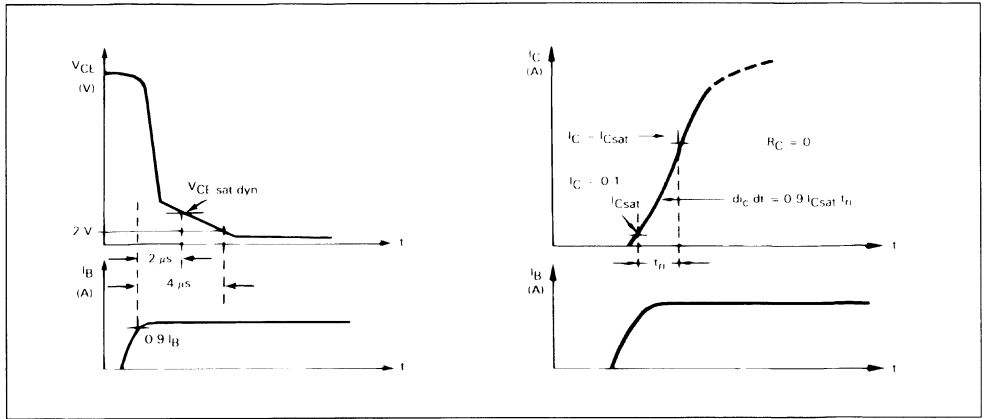

Figure 3a : Turn-off Switching Test Circuits.

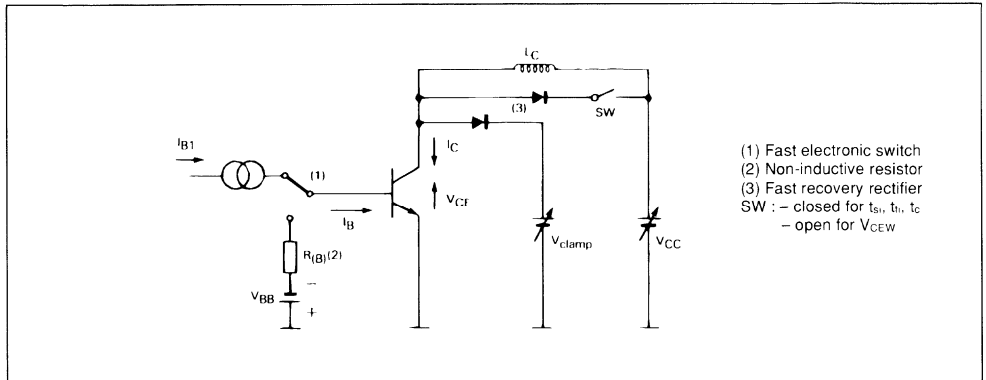
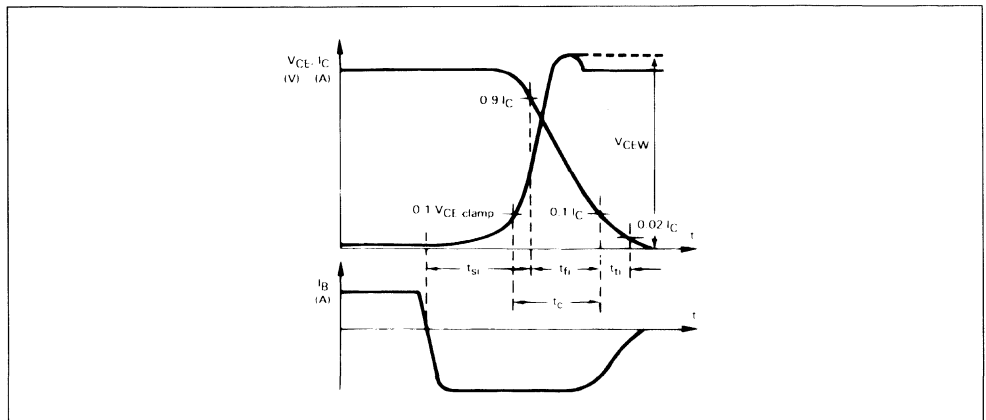
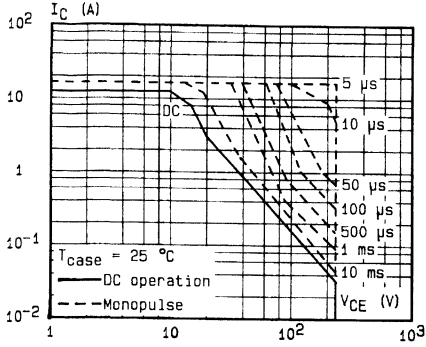

Figure 3b : Turn-off Switching Waveforms (inductive load).



DC and Pulse Area.



Power and $I_{S/B}$ Derating vs. Case Temperature.

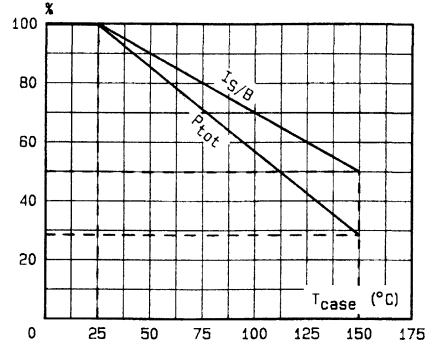

Transient Thermal Response.

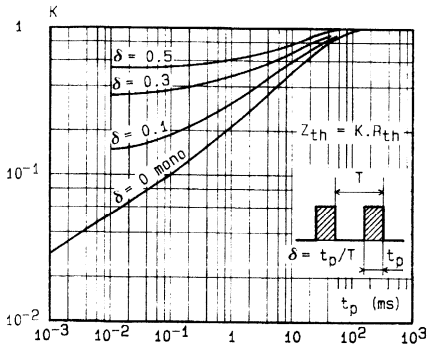

Collector-emitter Voltage vs. Base-emitter Resistance.

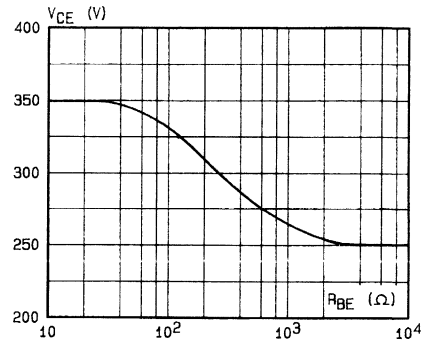

DC Current Gain.

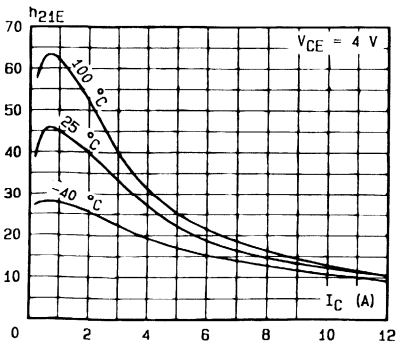

Minimum Base Current to saturate the Transistor.

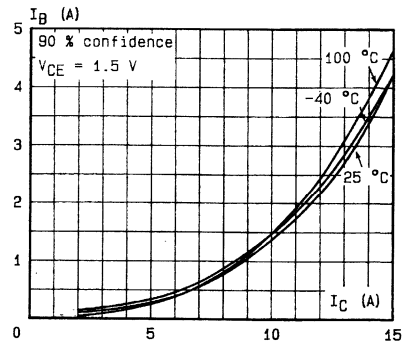

Saturation Voltage.

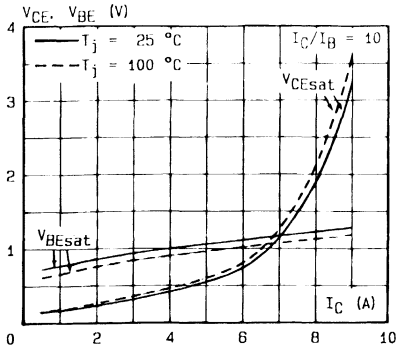

Saturation Voltage.

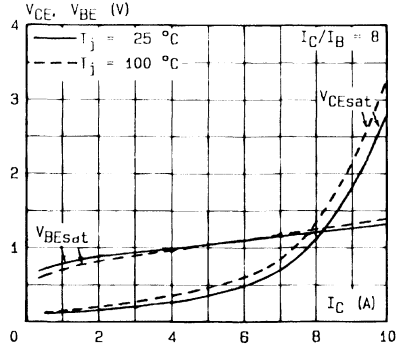

Switching Times versus Collector Current (resistive load).

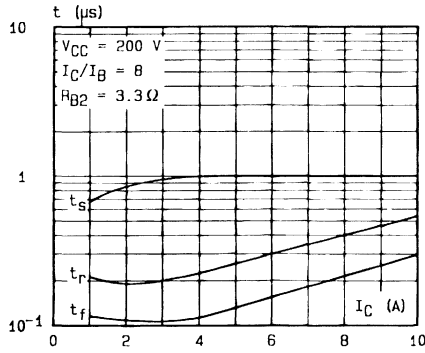

Switching Times versus Collector Current (inductive load).

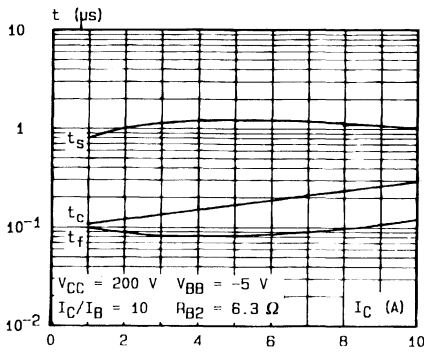

Switching Times versus Collector Current (inductive load).

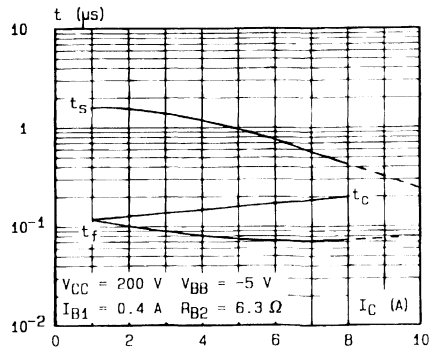

SWITCHING OPERATING AND OVERLOAD AREAS

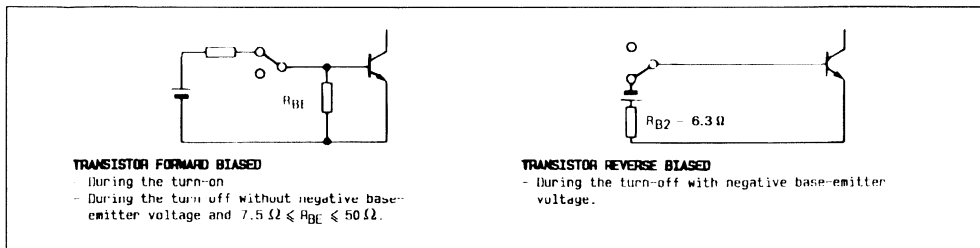

Forward Biased Safe Operating Area (FBSOA).

Reverse Biased Safe Operating Area (RBSOA).

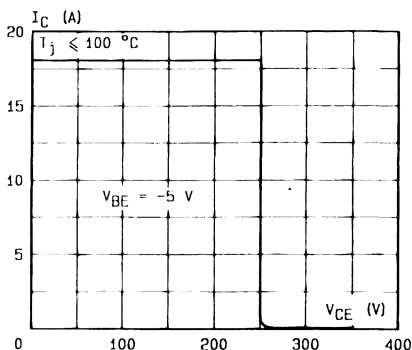
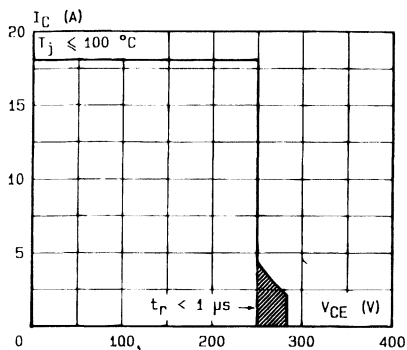

The hatched zone can only be used for turn-on.

Forward Biased Accidental Overload Area (FBAOA).

Reverse Biased Accidental Overload Area (RBAOA).

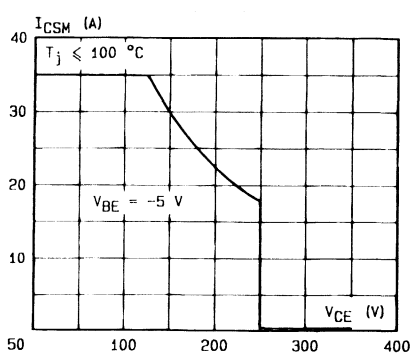
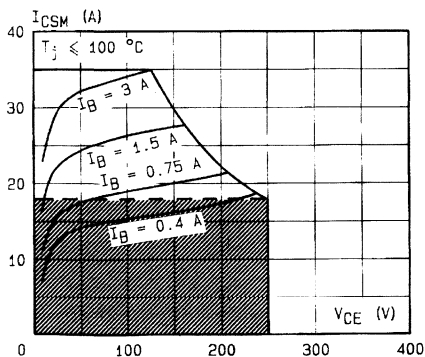

The Kellogg network (heavy point) allows the calculation of the maximum value of the short-circuit for a given base current I_B (90% confidence).

After the accidental overload current the RBAOA has to be used for the turn-off.

High accidental surge currents ($I > I_{CM}$) are allowed if they are non repetitive and applied less than 3000 times during the component life.

FAST SWITCHING POWER TRANSISTOR

- FAST SWITCHING TIMES
- LOW SWITCHING LOSSES
- VERY LOW SATURATION VOLTAGE AND HIGH GAIN FOR REDUCED LOAD OPERATION

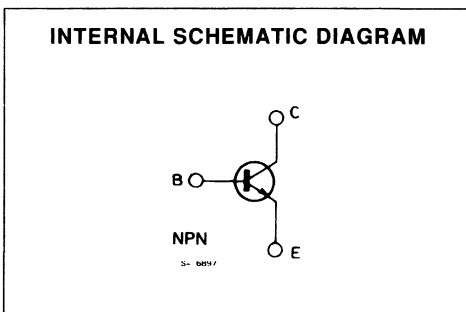
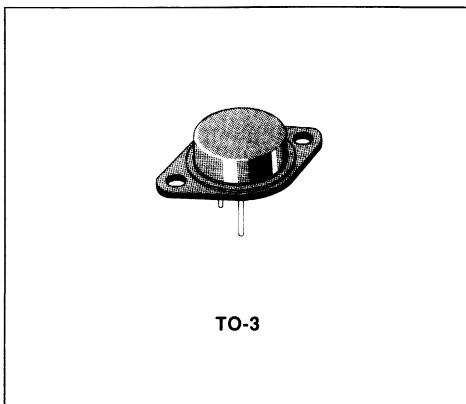

ABSOLUTE MAXIMUM RATINGS

Symbol	Parameter	Value	Unit
V_{CEV}	Collector-emitter Voltage ($V_{BE} = -1.5V$)	400	V
V_{CEO}	Collector-emitter Voltage ($I_B = 0$)	300	V
V_{EBO}	Emitter-base Voltage ($I_C = 0$)	7	V
I_C	Collector Current	12	A
I_{CM}	Collector Peak Current	18	A
I_B	Base Current	2.5	A
I_{BM}	Base Peak Current	4	A
P_{tot}	Total Dissipation at $T_c < 25^\circ C$	120	W
T_{stg}	Storage Temperature	- 65 to 200	$^\circ C$
T_j	Max. Operating Junction Temperature	200	$^\circ C$

THERMAL DATA

$R_{thj-case}$	Thermal Resistance Junction-case	Max	1.46	°C/W
----------------	----------------------------------	-----	------	------

ELECTRICAL CHARACTERISTICS ($T_{case} = 25^{\circ}C$ unless otherwise specified)

Symbol	Parameter	Test Conditions	Min.	Typ.	Max.	Unit
I_{CER}	Collector Cutoff Current ($R_{BE} = 10\Omega$)	$V_{CE} = V_{CEV}$			0.5	mA
		$V_{CE} = V_{CEV}$ $T_c = 100^{\circ}C$			2.5	mA
I_{CEV}	Collector Cutoff Current	$V_{CE} = V_{CEV}$ $V_{BE} = -1.5V$			0.5	mA
		$V_{CE} = V_{CEV}$ $V_{BE} = -1.5V$ $T_c = 100^{\circ}C$			2	mA
I_{EBO}	Emitter Cutoff Current ($I_C = 0$)	$V_{EB} = 5V$			1	mA
$V_{CEO(sus)}^*$	Collector Emitter Sustaining Voltage	$I_C = 0.2A$ $L = 25mH$	300			V
V_{EBO}	Emitter-base Voltage ($I_C = 0$)	$I_E = 50mA$	7			V
$V_{CE(sat)}^*$	Collector-emitter Saturation Voltage	$I_C = 4A$ $I_B = 0.4A$			0.9	V
		$I_C = 4A$ $I_B = 0.4A$ $T_j = 100^{\circ}C$			1.9	V
$V_{BE(sat)}^*$	Base-emitter Saturation Voltage	$I_C = 4A$ $I_B = 0.4A$			1.3	V
		$I_C = 4A$ $I_B = 0.4A$ $T_j = 100^{\circ}C$			1.5	V
di_c/dt	Rate of Rise of on-state Collector Current	$V_{CC} = 250V$ $R_C = 0$ $t_p = 3\mu s$ See fig. 1	25			A/ μs

INDUCTIVE LOAD

Symbol	Parameter	Test Conditions	Min.	Typ.	Max.	Unit
t_s	Storage Time	$V_{CC} = 250V$ $V_{clamp} = 300V$			3	μs
t_f	Fall Time	$I_C = 4A$ $I_B = 0.4A$			0.4	μs
t_c	Crossover Time	$V_{BB} = -5V$ $R_{B2} = 6.25\Omega$			0.7	μs
		$L_C = 3.1mH$ $T_j = 100^{\circ}C$ see fig. 2				
V_{CEW}	Maximum Collector Emitter Voltage without Snubber	$V_{CC} = 50V$ $I_{Cwoff} = 6A$ $V_{BB} = -5V$ $I_{B1} = 0.4A$ $L_C = 0.42mH$ $R_{BB} = 6.25\Omega$ $T_j = 125^{\circ}C$ See fig. 2	300			V

Figure 1 : Turn-on Switching Characteristics of the Transistor.

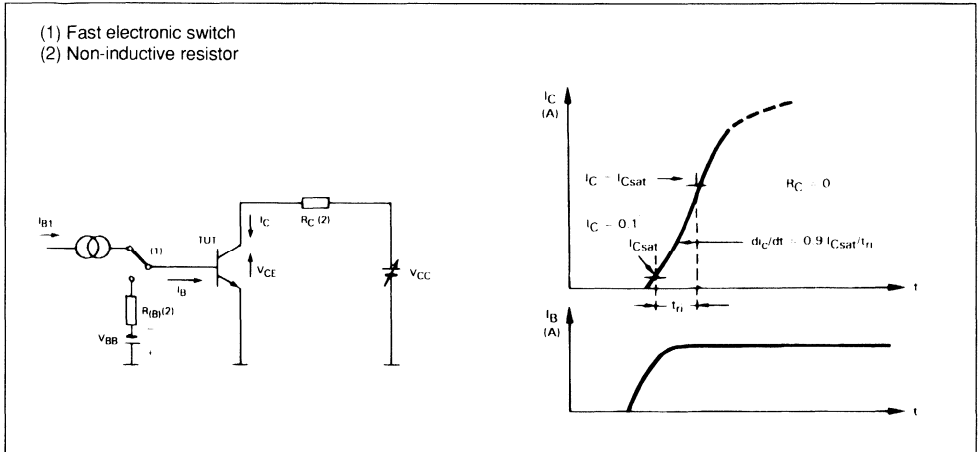
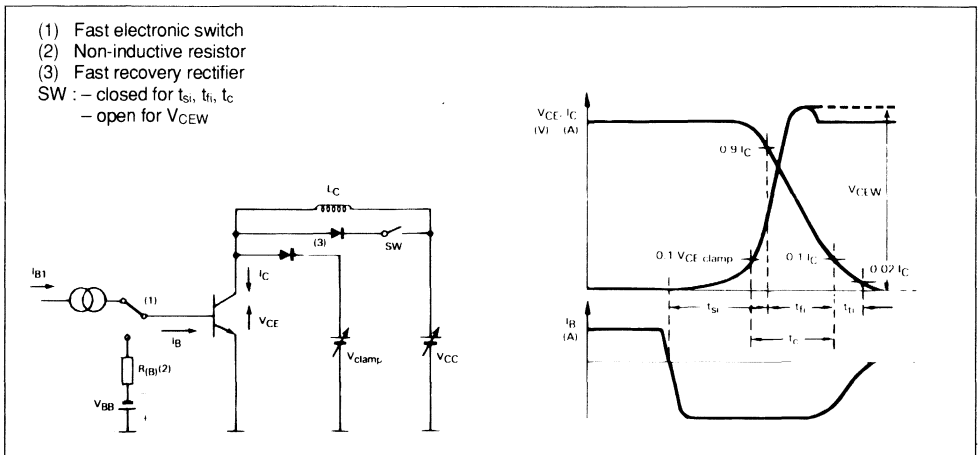
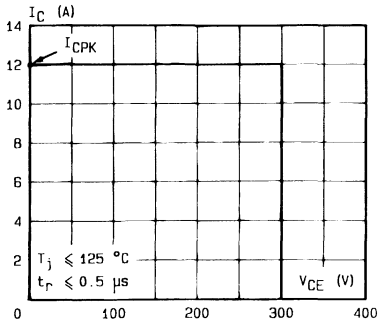

Figure 2 : Turn-off Switching Characteristics of the Transistor.



Forward Biased Safe Operating Area (FBSOA).



Reverse Biased Safe Operating Area (RBSOA).

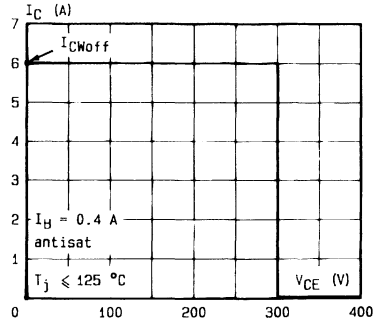

HIGH VOLTAGE POWER SWITCH

DESCRIPTION

The BUV46/A and BUV46FI/AFI are silicon multi-epitaxial mesa NPN transistors in the jedec TO-220 plastic package and ISOWATT220 fully isolated package respectively, intended for high voltage, fast switching applications.

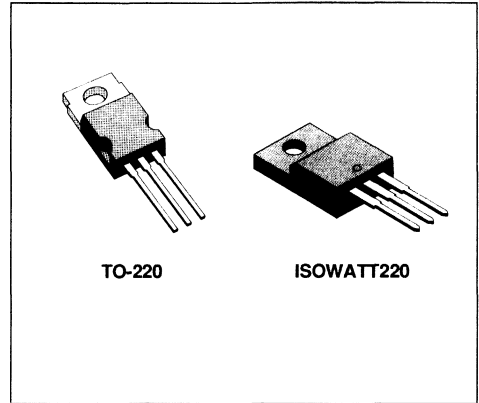

INTERNAL SCHEMATIC DIAGRAM

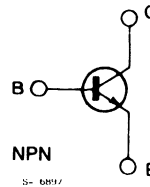

ABSOLUTE MAXIMUM RATINGS

Symbol	Parameter	TO-220 ISOWATT220	BUV46 BUV46FI	BUV46A BUV46AFI	Unit
V_{CES}	Collector-emitter Voltage ($V_{BE} = 0$)		850	1000	V
V_{CEX}	Collector-emitter Voltage ($V_{BE} = -2.5V$)		850	1000	V
V_{CEO}	Collector-emitter Voltage ($I_B = 0$)		400	450	V
V_{EBO}	Emitter-base Voltage ($I_C = 0$)		7		V
I_C	Collector Current		5		A
I_B	Base Current		3		A
			TO-220	ISOWATT220	
P_{tot}	Total Power Dissipation at $T_c < 25^\circ C$		70	30	W
T_{stg}	Storage Temperature		- 65 to 150		$^\circ C$
T_j	Max. Operating Junction Temperature		150		$^\circ C$

THERMAL DATA

			TO-220	ISOWATT220	
$R_{th\ J-case}$	Thermal Resistance Junction-case	max	1.76	4.12	°C/W

ELECTRICAL CHARACTERISTICS ($T_{case} = 25^{\circ}C$ unless otherwise specified)

Symbol	Parameter	Test Conditions	Min.	Typ.	Max.	Unit
I_{CER}	Collector Cutoff Current ($R_{BE} = 10\Omega$)	$V_{CE} = V_{CEX}$			0.1	mA
		$V_{CE} = V_{CEX} T_c = 125^{\circ}C$			1	mA
I_{CEX}	Collector Cutoff Current	$V_{CE} = V_{CEX} V_{BE} = -2.5V$			0.3	mA
		$V_{CE} = V_{CEX} V_{BE} = -2.5V T_c = 125^{\circ}C$			2	mA
I_{EBO}	Emitter Cutoff Current ($I_C = 0$)	$V_{EB} = 7V$			1	mA
$V_{CEO(sus)}^*$	Collector-emitter Sustaining Voltage	$I_C = 100mA$ for BUV46/FI for BUV46A/AFI	400 450			V V
$V_{CE(sat)}^*$	Collector-emitter Saturation Voltage	for BUV46/FI			1.5	V
		$I_C = 2.5A$ $I_B = 0.5A$			5	V
		$I_C = 3.5A$ $I_B = 0.7A$			1.5	V
		for BUV46A/AFI			5	V
$V_{BE(sat)}^*$	Base-emitter Saturation Voltage	for BUV46/FI			1.3	V
		$I_C = 2.5A$ $I_B = 0.5A$			1.3	V
		for BUV46A/AFI			1.3	V
		$I_C = 2A$ $I_B = 0.4A$				
t_{on}	Turn-on Time	$I_C = 2.5A$ $V_{CC} = 150V$			1	μs
t_s	Storage Time	$I_{B1} = -I_{B2} = 0.5A$			3	μs
t_f	Fall Time	for BUV46/FI			0.8	μs
t_{on}	Turn-on Time	$I_C = 2A$ $V_{CC} = 150V$			1	μs
t_s	Storage Time	$I_{B1} = -I_{B2} = 0.4A$			3	μs
t_f	Fall Time	for BUV46A/AFI			0.8	μs

* Pulsed : pulse duration = 300 μs , duty cycle = 1.5%.

FAST SWITCHING POWER TRANSISTOR

- FAST SWITCHING TIMES
- LOW SWITCHING LOSSES
- VERY LOW SATURATION VOLTAGE AND HIGH GAIN FOR REDUCED LOAD OPERATION

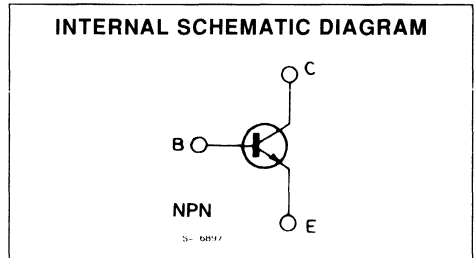
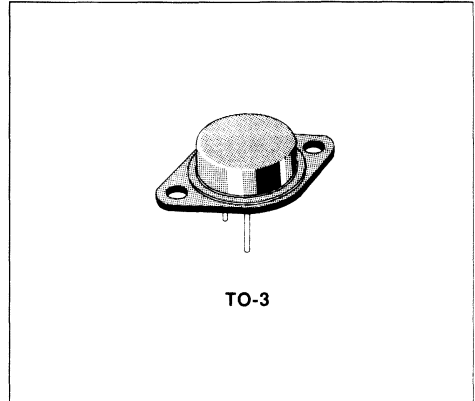

ABSOLUTE MAXIMUM RATINGS

Symbol	Parameter	Value	Unit
V_{CEV}	Collector-emitter Voltage ($V_{BE} = -1.5V$)	250	V
V_{CEO}	Collector-emitter Voltage ($I_B = 0$)	125	V
V_{EBO}	Emitter-base Voltage ($I_C = 0$)	7	V
I_C	Collector Current	25	A
I_{CM}	Collector Peak Current	50	A
I_B	Base Current	6	A
I_{BM}	Base Peak Current	12	A
P_{base}	Reverse Bias Base Power Dissipation (B.E. junction in avalanche)	2	W
P_{tot}	Total Dissipation at $T_C < 25^\circ C$	150	W
T_{stg}	Storage Temperature	- 65 to 200	$^\circ C$
T_J	Max. Operating Junction Temperature	150	$^\circ C$

THERMAL DATA

$R_{thj-case}$	Thermal Resistance Junction-case	Max	1.17	°C/W
----------------	----------------------------------	-----	------	------

ELECTRICAL CHARACTERISTICS ($T_{case} = 25^{\circ}C$ unless otherwise specified)

Symbol	Parameter	Test Conditions	Min.	Typ.	Max.	Unit
I_{CER}	Collector Cutoff Current ($R_{BE} = 10\Omega$)	$V_{CE} = V_{CEV}$ $V_{CE} = V_{CEV}$ $T_c = 100^{\circ}C$			1 5	mA mA
I_{CEV}	Collector Cutoff Current	$V_{CE} = V_{CEV}$ $V_{BE} = -1.5V$ $V_{CE} = V_{CEV}$ $V_{BE} = -1.5V$ $T_c = 100^{\circ}C$			1 5	mA mA
I_{EBO}	Emitter Cutoff Current ($I_C = 0$)	$V_{EB} = 5V$			1	mA
$V_{CEO(sus)*}$	Collector Emitter Sustaining Voltage	$I_C = 0.2A$ $L = 25mH$	125			V
V_{EBO}	Emitter-base Voltage ($I_C = 0$)	$I_E = 50mA$	7			V
$V_{CE(sat)*}$	Collector-emitter Saturation Voltage	$I_C = 10A$ $I_B = 0.5A$ $I_C = 20A$ $I_B = 2A$ $I_C = 24A$ $I_B = 3A$ $I_C = 10A$ $I_B = 0.5A$ $T_J = 100^{\circ}C$ $I_C = 20A$ $I_B = 2A$ $T_J = 100^{\circ}C$ $I_C = 24A$ $I_B = 3A$ $T_J = 100^{\circ}C$		0.4 0.6 0.7 0.5 0.75 0.9	0.8 0.9 1.2 0.9 1.5 1.8	V V V V V V
$V_{BE(sat)*}$	Base-emitter Saturation Voltage	$I_C = 20A$ $I_B = 2A$ $I_C = 24A$ $I_B = 3A$ $I_C = 20A$ $I_B = 2A$ $T_J = 100^{\circ}C$ $I_C = 24A$ $I_B = 3A$ $T_J = 100^{\circ}C$		1.25 1.35 1.25 1.45	1.6 1.7 1.7 1.9	V V V V
di_c/dt	Rate of Rise of On-state Collector Current	$V_{CC} = 100V$ $R_C = 0$ See fig. 2	$I_{B1} = 3A$ $T_J = 25^{\circ}C$ $T_J = 100^{\circ}C$	50 45	100 85	A/ μs A/ μs
$V_{CE(2\mu s)}$	Collector-emitter Dynamic Voltage	$V_{CC} = 100V$ $I_{B1} = 2A$ See fig. 2	$R_C = 5\Omega$ $T_J = 25^{\circ}C$ $T_J = 100^{\circ}C$		1.4 2.1	3 4 V V
$V_{CE(4\mu s)}$	Collector-emitter Dynamic Voltage	$V_{CC} = 100V$ $I_{B1} = 2A$ See fig. 2	$R_C = 5\Omega$ $T_J = 25^{\circ}C$ $T_J = 100^{\circ}C$		1.1 1.5	2 2.5 V V

ELECTRICAL CHARACTERISTICS (continued)

TURN-OFF SWITCHING CHARACTERISTICS

On Inductive Load (with negative bias)

Symbol	Test Conditions		Min.	Typ.	Max.	Unit
t_{si}	$T_j = 25\text{ }^\circ\text{C}$	$I_C = 20\text{ A}, I_B = 2\text{ A}, V_{BB} = -5\text{ V}$ $V_{CC} = 100\text{ V}, V_{clamp} = 125\text{ V}$ $L_C = 0.25\text{ mH}, R_{B2} = 1.3\text{ }\Omega$ See fig. 3		0.85	1.4	μs
	$T_j = 100\text{ }^\circ\text{C}$			1.2	1.7	
t_{fi}	$T_j = 25\text{ }^\circ\text{C}$			0.09	0.2	
	$T_j = 100\text{ }^\circ\text{C}$			0.17	0.3	
t_{ti}	$T_j = 25\text{ }^\circ\text{C}$			0.04	0.05	
	$T_j = 100\text{ }^\circ\text{C}$			0.07	0.1	
t_c	$T_j = 25\text{ }^\circ\text{C}$		0.16	0.3		
	$T_j = 100\text{ }^\circ\text{C}$		0.3	0.5		

TURN-OFF SWITCHING CHARACTERISTICS

On Inductive Load (without negative bias)

Symbol	Test Conditions		Min.	Typ.	Max.	Unit
t_{si}	$T_j = 25\text{ }^\circ\text{C}$	$I_C = 20\text{ A}, I_B = 2\text{ A}, V_{BB} = 0\text{ V}$ $V_{CC} = 100\text{ V}, V_{clamp} = 125\text{ V}$ $L_C = 0.25\text{ mH}, R_{B2} = 4.7\text{ }\Omega$ See fig. 3		2.1		μs
	$T_j = 100\text{ }^\circ\text{C}$			3.2		
t_{fi}	$T_j = 25\text{ }^\circ\text{C}$			0.7		
	$T_j = 100\text{ }^\circ\text{C}$			1.2		
t_{ti}	$T_j = 25\text{ }^\circ\text{C}$			0.28		
	$T_j = 100\text{ }^\circ\text{C}$			0.55		

* Pulsed : Pulse duration = 300 μs , duty cycle = 2 %.

Figure 1 : Switching Times Test Circuit (resistive load).

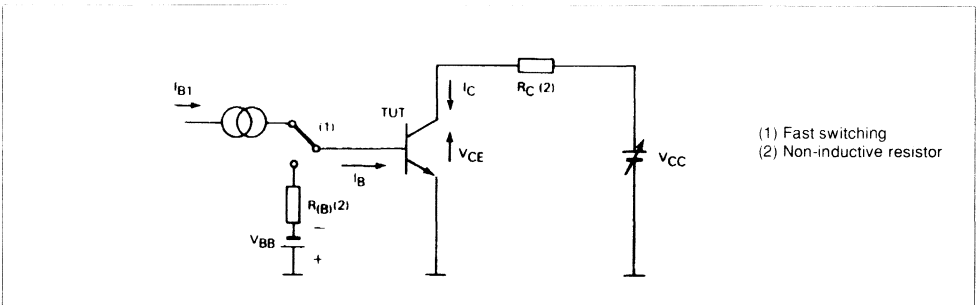

Figure 2 : Turn-on Switching Waveforms.

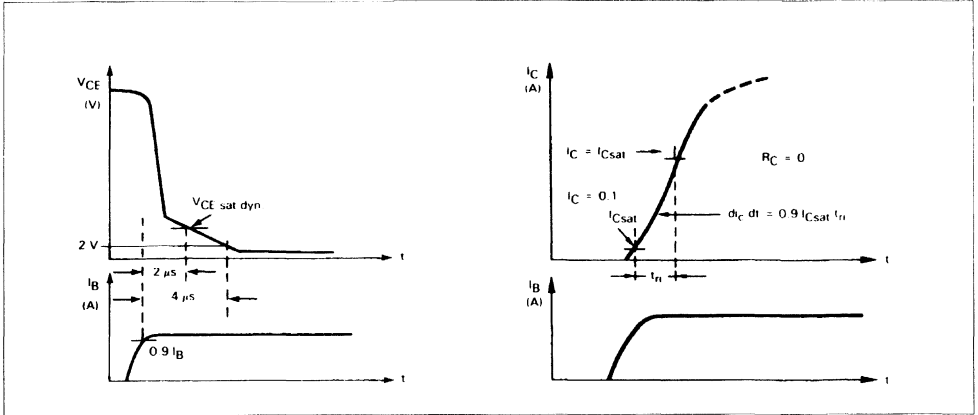

Figure 3a : Turn-off Switching Test Circuit.

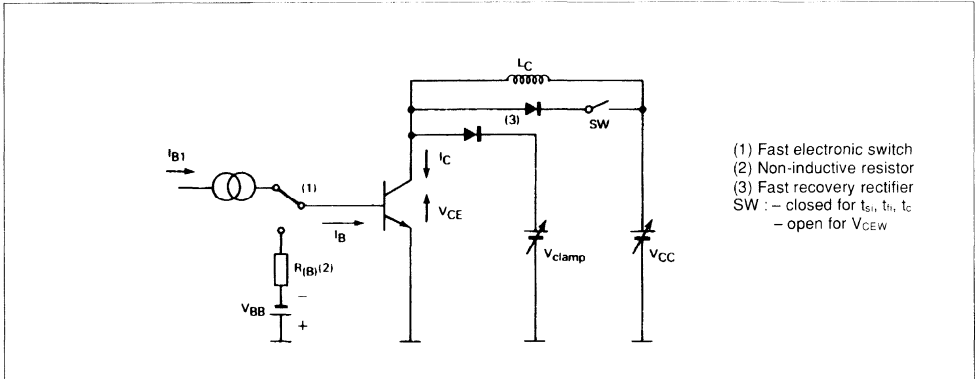
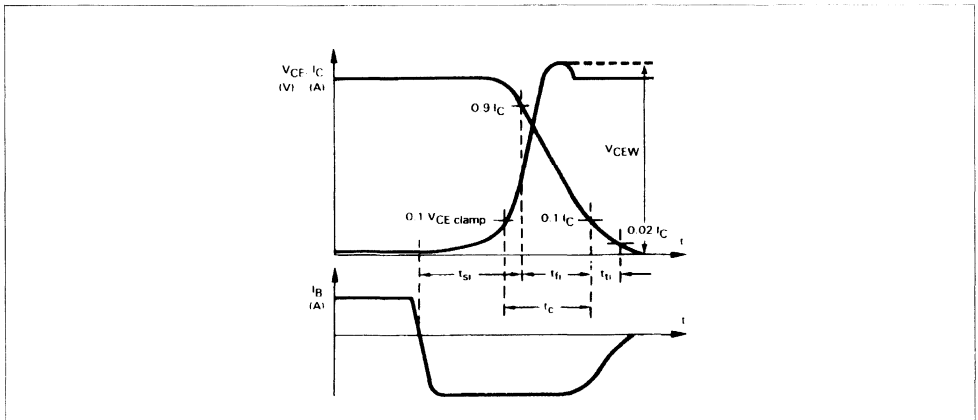
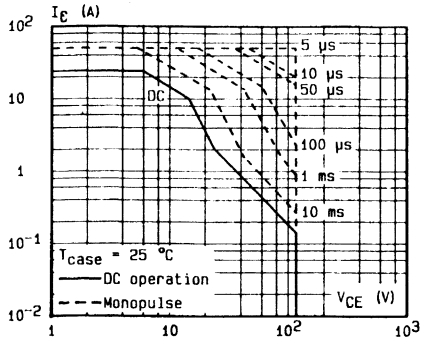

Figure 3b : Turn-off Switching Waveforms (inductive load).



DC and AC Pulse Area.



Power and $I_{S/B}$ Derating versus Case Temperature.

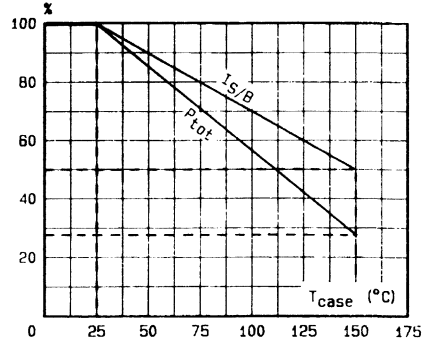

Transient Thermal Response.

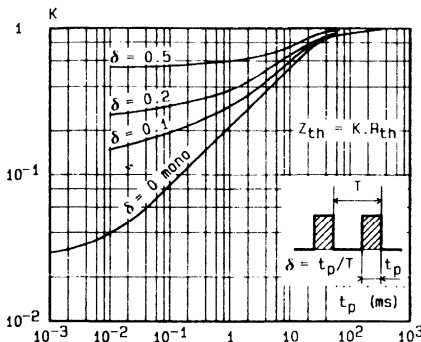

Collector-emitter Voltage versus Base-emitter Resistance.

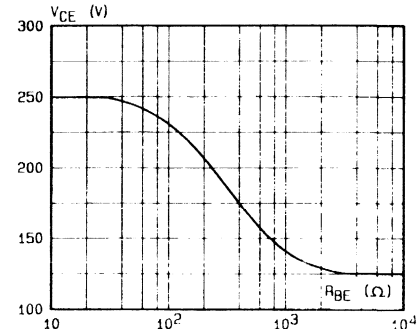

DC Current Gain.

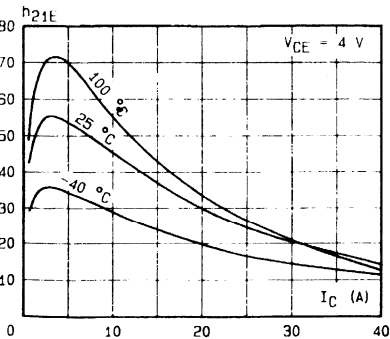

Minimum Base Current to saturate the Transistor.

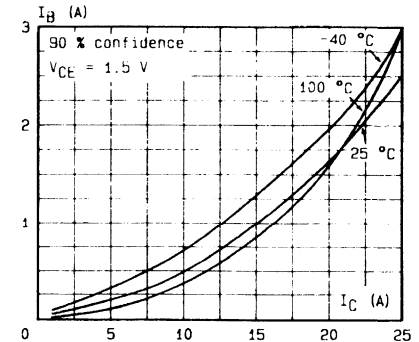

Saturation Voltage.

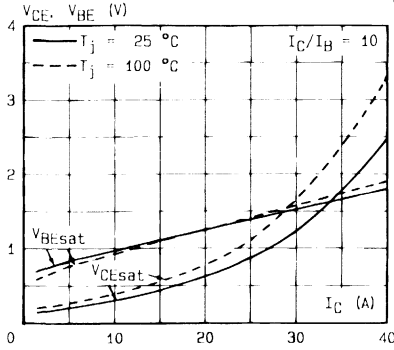

Saturation voltage

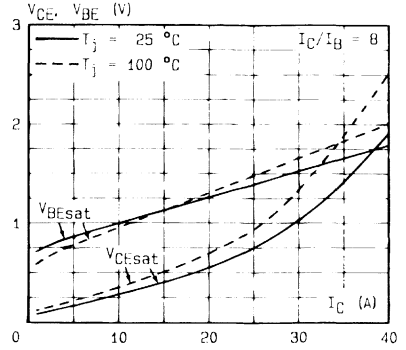

Switching Times versus Collector Current (resistive load).

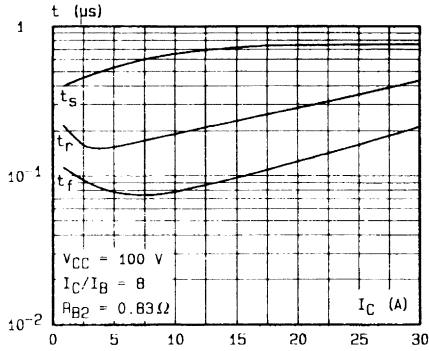

Switching Times versus Collector Current (inductive load).

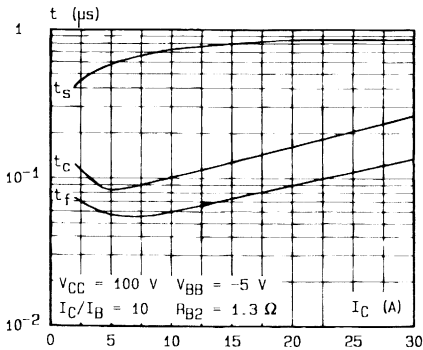

Switching Times versus Collector Current (inductive load).

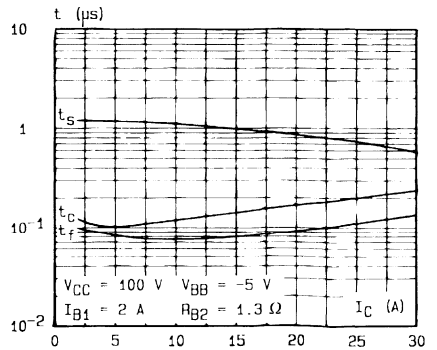

SWITCHING OPERATING AND OVERLOAD AREAS

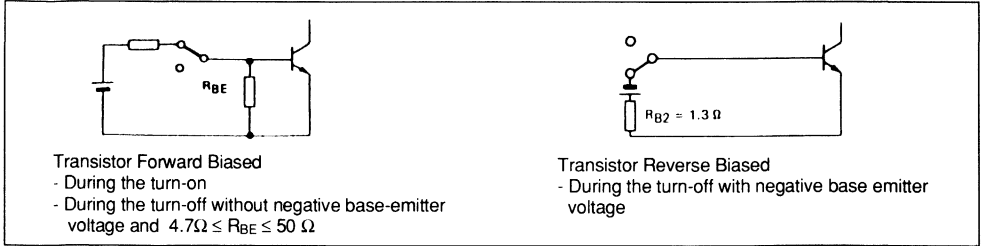

Forward Biased Safe Operating Area (FBSOA).

Reverse Biased Safe Operating Area (RBSOA).

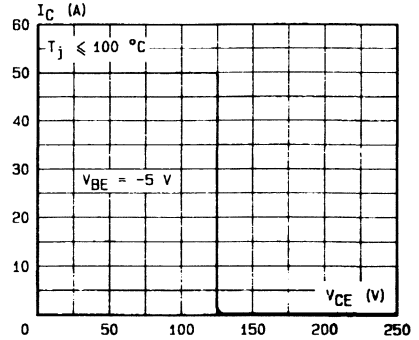
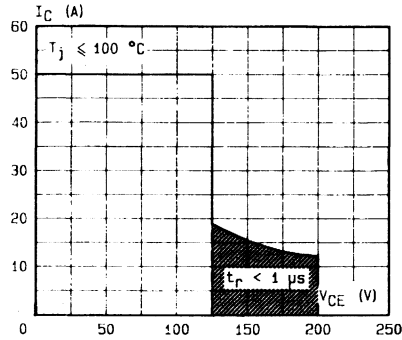

The hatched zone can only be used for turn-on.

Forward Biased Accidental Overload Area (FBAOA).

Reverse Biased Accidental Overload Area (RBAOA).

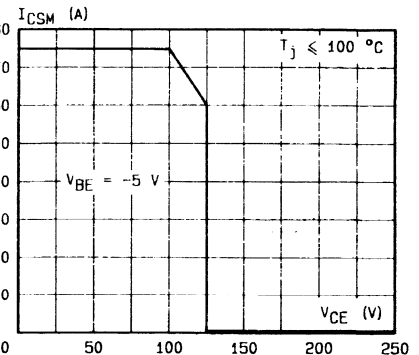
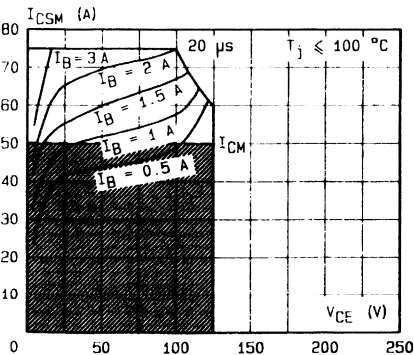

The Kellog network (heavy point) allows the calculation of the maximum value of the short-circuit for a given base current I_B (90 % confidence).

After the accidental overload current the RBAOA has to be used for the turn-off.

High accidental surge currents ($I > I_{CM}$) are allowed if they are non repetitive and applied less than 3000 times during the component life.

FAST SWITCHING POWER TRANSISTOR

- FAST SWITCHING TIMES
- LOW SWITCHING LOSSES
- VERY LOW SATURATION VOLTAGE AND HIGH GAIN FOR REDUCED LOAD OPERATION

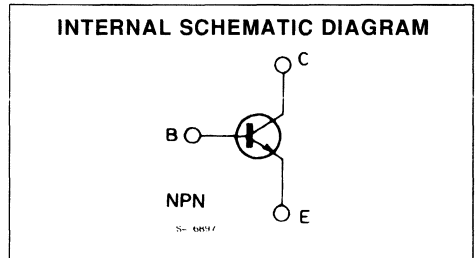
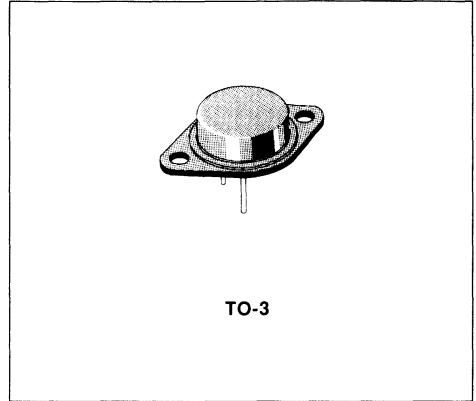

ABSOLUTE MAXIMUM RATINGS

Symbol	Parameter	Value	Unit
V_{CEV}	Collector-emitter Voltage ($V_{BE} = -1.5\text{ V}$)	300	V
V_{CEO}	Collector-emitter Voltage ($I_B = 0$)	200	V
V_{EBO}	Emitter-base Voltage ($I_C = 0$)	7	V
I_C	Collector Current	20	A
I_{CM}	Collector Peak Current	28	A
I_B	Base Current	4	A
I_{BM}	Base Peak Current	7	A
P_{base}	Reverse Bias Base Dissipation (B.E. junction in avalanche)	1	W
P_{tot}	Total Dissipation at $T_C < 25^\circ\text{C}$	150	W
T_{stg}	Storage Temperature	- 65 to 200	$^\circ\text{C}$
T_j	Max. Operating Junction Temperature	200	$^\circ\text{C}$

THERMAL DATA

$R_{thj-case}$	Thermal Resistance Junction-case	max	1.17	°C/W
----------------	----------------------------------	-----	------	------

ELECTRICAL CHARACTERISTICS ($T_{case} = 25^{\circ}C$ unless otherwise specified)

Symbol	Parameter	Test Conditions	Min.	Typ.	Max.	Unit
I_{CER}	Collector Cutoff Current ($R_{BE} = 10\Omega$)	$V_{CE} = V_{CEV}$			0.5	mA
		$V_{CE} = V_{CEV}$ $T_c = 100^{\circ}C$			2.5	mA
I_{CEV}	Collector Cutoff Current	$V_{CE} = V_{CEV}$ $V_{BE} = -1.5V$			0.5	mA
		$V_{CE} = V_{CEV}$ $V_{BE} = -1.5V$ $T_c = 100^{\circ}C$			2	mA
I_{EBO}	Emitter Cutoff Current ($I_C = 0$)	$V_{EB} = 5V$			1	mA
$V_{CE0(sus)*}$	Collector Emitter Sustaining Voltage	$I_C = 0.2A$ $L = 25mH$	200			V
V_{EBO}	Emitter-base Voltage ($I_C = 0$)	$I_E = 50mA$	7			V
$V_{CE(sat)*}$	Collector-emitter Saturation Voltage	$I_C = 5A$ $I_B = 0.25A$		0.4	0.8	V
		$I_C = 10A$ $I_B = 1A$		0.45	0.9	V
		$I_C = 14A$ $I_B = 1.75A$		0.68	1.2	V
		$I_C = 5A$ $I_B = 0.25A$ $T_j = 100^{\circ}C$		0.4	0.9	V
		$I_C = 10A$ $I_B = 1A$ $T_j = 100^{\circ}C$		0.6	1.5	V
		$I_C = 14A$ $I_B = 1.75A$ $T_j = 100^{\circ}C$		0.9	1.9	V
$V_{BE(sat)*}$	Base-emitter Saturation Voltage	$I_C = 10A$ $I_B = 1A$		1.1	1.4	V
		$I_C = 14A$ $I_B = 1.75A$		1.3	1.7	V
		$I_C = 10A$ $I_B = 1A$ $T_j = 100^{\circ}C$		1	1.4	V
		$I_C = 14A$ $I_B = 1.75A$ $T_j = 100^{\circ}C$		1.2	1.7	V
di_C/dt	Rated of Rise of on-state Collector Current	$V_{CC} = 160V$ $R_C = 0$ $I_{B1} = 1.5A$ $T_j = 25^{\circ}C$	35	75		A/ μs
		See fig. 2 $T_j = 100^{\circ}C$	30	65		A/ μs
$V_{CE(2\mu s)}$	Collector Emitter Dynamic Voltage	$V_{CC} = 160V$ $I_{B1} = 1A$ $R_C = 16\Omega$ $T_j = 25^{\circ}C$		1.8	3	V
		See fig. 2 $T_j = 100^{\circ}C$		3	5	V
$V_{CE(4\mu s)}$	Collector Emitter Dynamic Voltage	$V_{CC} = 160V$ $I_{B1} = 1A$ $R_C = 16\Omega$ $T_j = 25^{\circ}C$		1.1	1.7	V
		See fig. 2 $T_j = 100^{\circ}C$		1.4	2.5	V

ELECTRICAL CHARACTERISTICS (continued)

RESISTIVE LOAD

Symbol	Parameter	Test Conditions		Min.	Typ.	Max.	Unit
t_r	Rise Time	$V_{CC} = 160V$	$I_C = 14A$		0.3	0.6	μs
t_s	Storage Time	$V_{BB} = -5V$	$I_B = 1.7A$		0.6	1.4	μs
t_f	Fall Time	$R_{B2} = 1.4\Omega$	$t_p = 30\mu s$		0.12	0.3	μs
		See fig. 1					

INDUCTIVE LOAD

Symbol	Parameter	Test Conditions		Min.	Typ.	Max.	Unit
t_s	Storage Time	$V_{CC} = 160V$	$V_{clamp} = 200V$		0.7	1.5	μs
t_f	Fall Time	$I_C = 10A$	$I_B = 1A$		0.06	0.2	μs
t_t	Tail Time in Turn-on	$V_{BB} = -5V$	$R_{B2} = 2.5\Omega$		0.01	0.07	μs
t_c	Crossover Time	$L_C = 0.8mH$	See fig. 3		0.13	0.3	μs
t_s	Storage Time	$V_{CC} = 160V$	$V_{clamp} = 200V$		1.1	2	μs
t_f	Fall Time	$I_C = 10A$	$I_B = 1A$		0.12	0.3	μs
t_t	Tail Time in Turn-on	$V_{BB} = -5V$	$R_{B2} = 2.5\Omega$		0.03	0.15	μs
t_c	Crossover Time	$L_C = 0.8mH$	$T_j = 100^\circ C$		0.24	0.5	μs
		See fig. 3					
t_s	Storage Time	$V_{CC} = 160V$	$V_{clamp} = 200V$		1.5		μs
t_f	Fall Time	$I_C = 10A$	$I_B = 1A$		0.5		μs
t_t	Tail Time in Turn-on	$V_{BB} = 0$	$R_{B2} = 4.7\Omega$		0.12		μs
		See fig. 3					
t_s	Storage Time	$V_{CC} = 160V$	$V_{clamp} = 200V$		2.7		μs
t_f	Fall Time	$I_C = 10A$	$I_B = 1A$		0.85		μs
t_t	Tail Time in Turn-on	$V_{BB} = 0$	$R_{B2} = 4.7\Omega$		0.25		μs
		See fig. 3					

* Pulsed : Pulse duration = 300 μs , duty cycle = 2 %.

Figure 1 : Switching Times Test Circuit (resistive load).

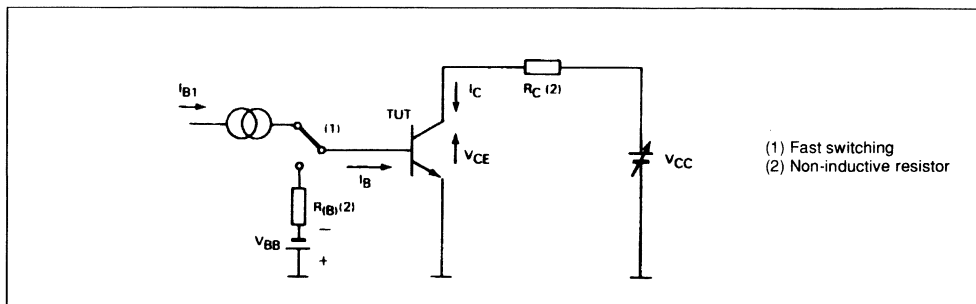

Figure 2 : Turn-on Switching Waveforms.

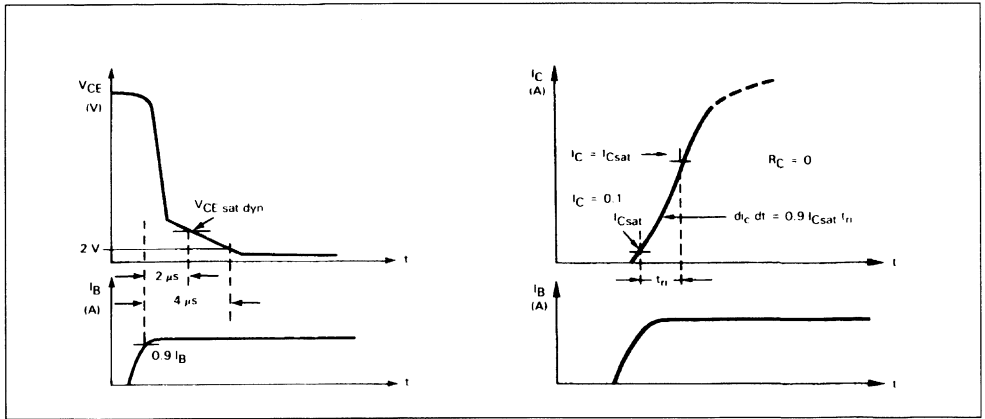
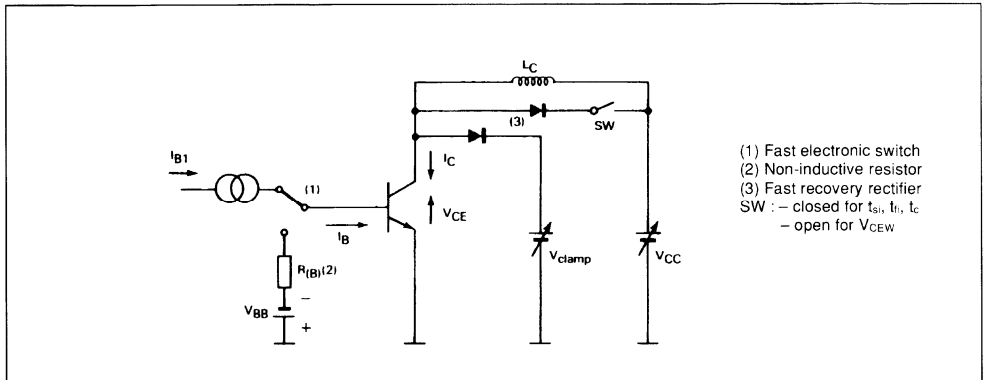
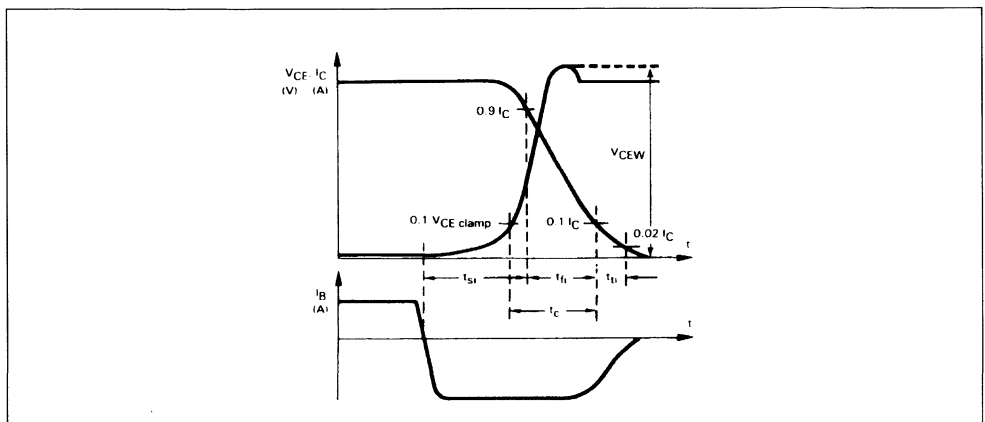

Figure 3a : Turn-off Switching Test Circuit.



- (1) Fast electronic switch
 - (2) Non-inductive resistor
 - (3) Fast recovery rectifier
- SW : - closed for t_{s1} , t_{f1} , t_{r1}
 - open for V_{CEW}

Figure 3b : Turn-off Switching Waveforms (inductive load).



DC and AC Pulse Area.

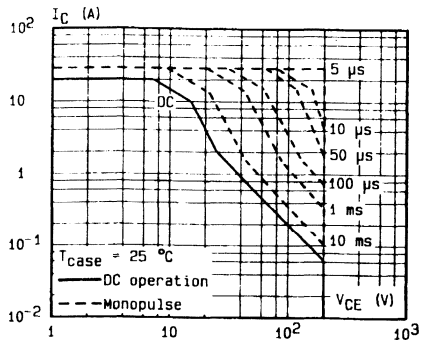

Power and $I_{S/B}$ Derating versus Case Temperature.

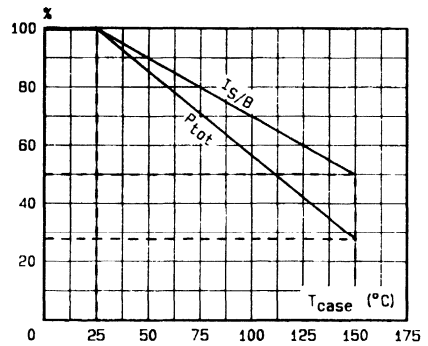

Transient Thermal Response.

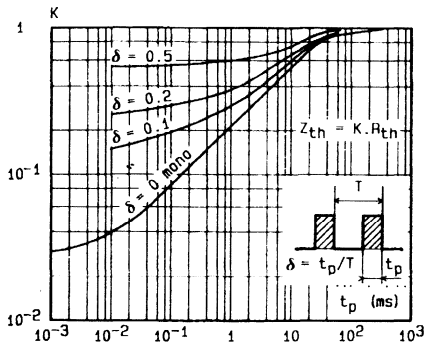

Collector-emitter Voltage versus Base-emitter Resistance.

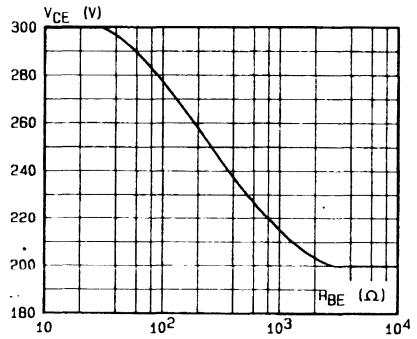

DC Current Gain.

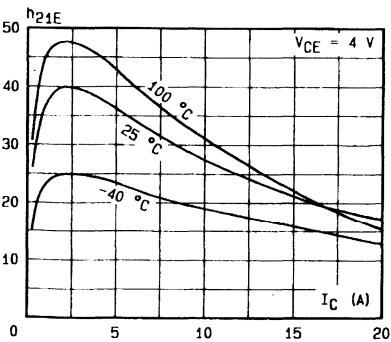

Minimum Base Current to saturate the Transistor.

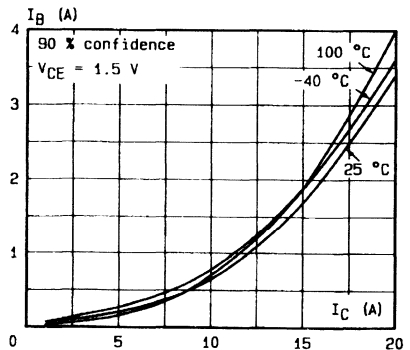

Saturation Voltage.

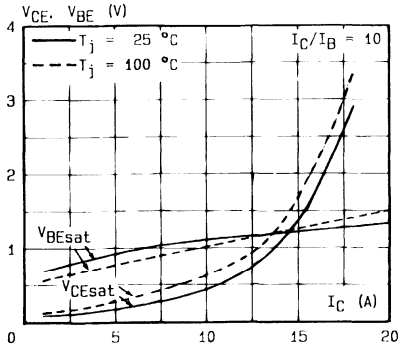

Saturation Voltage.

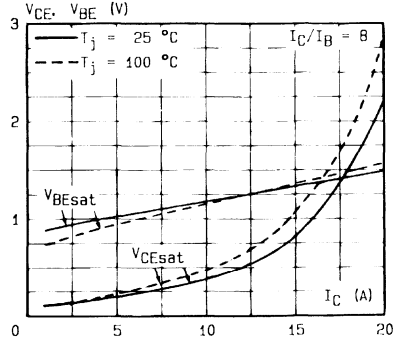

Switching Times versus Collector Current (resistive load).

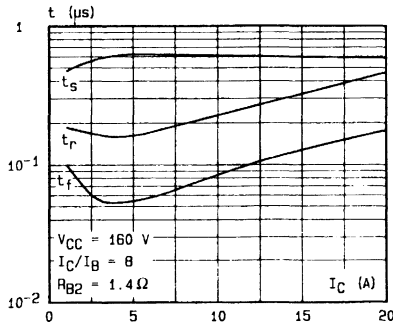

Switching Times versus Collector Current (inductive load).

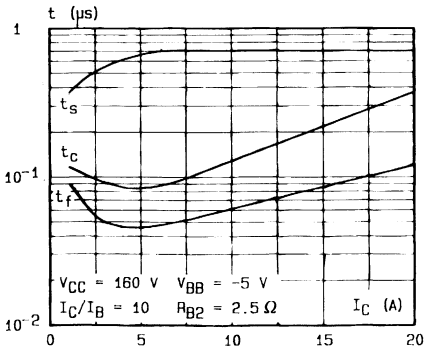

Switching Times versus Collector Current (inductive load).

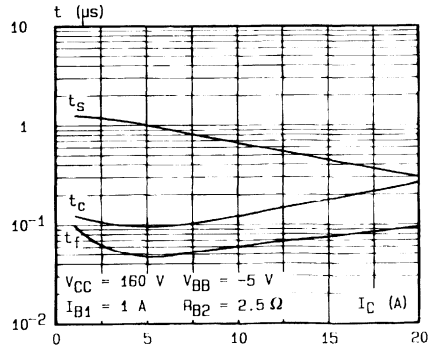

SWITCHING OPERATING AND OVERLOAD AREAS

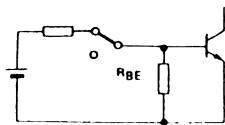

Transistor Forward Biased

- During the turn-on
- During the turn-off without negative base-emitter voltage and $4.7\Omega \leq R_{BE} \leq 50\Omega$

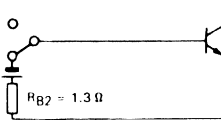

Transistor Reverse Biased

- During the turn-off with negative base emitter voltage

Forward Biased Safe Operating Area (FBSOA).

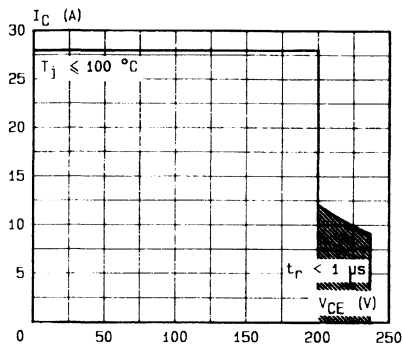

The hatched zone can only be used for turn-on.

Reverse Biased Safe Operating Area (RBSOA).

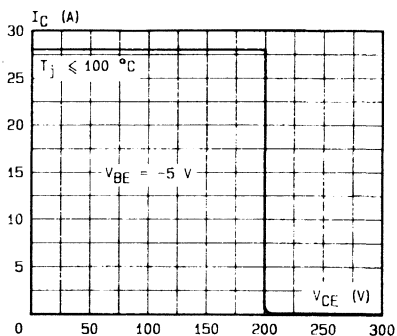

Forward Biased Accidental Overload Area (FBAOA).

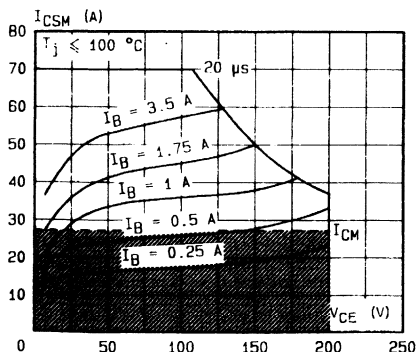

The Kellogg network (heavy point) allows the calculation of the maximum value of the short-circuit for a given base current I_B (90 % confidence).

High accidental surge currents ($I > I_{CM}$) are allowed if they are non repetitive and applied less than 3000 times during the component life.

Reverse Biased Accidental Overload Area (RBAOA).

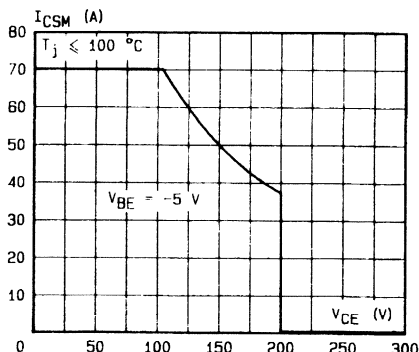

After the accidental overload current the RBAOA has to be used for the turn-off.

FAST SWITCHING POWER TRANSISTOR

- FAST SWITCHING TIMES
- LOW SWITCHING LOSSES
- VERY LOW SATURATION VOLTAGE AND HIGH GAIN FOR REDUCED LOAD OPERATION

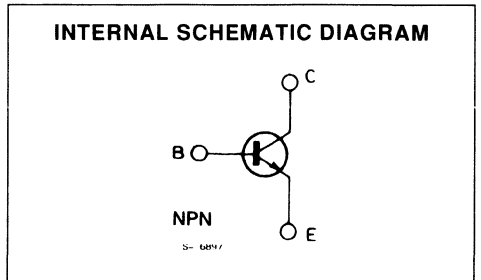
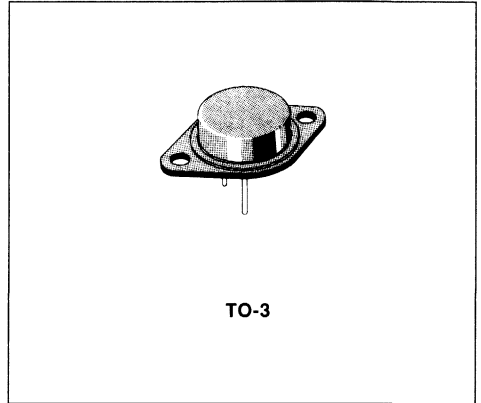

ABSOLUTE MAXIMUM RATINGS

Symbol	Parameter	Value	Unit
V_{CEV}	Collector-emitter Voltage ($V_{BE} = -1.5V$)	350	V
V_{CEO}	Collector-emitter Voltage ($I_B = 0$)	250	V
V_{EBO}	Emitter-base Voltage ($I_C = 0$)	7	V
I_C	Collector Current	20	A
I_{CM}	Collector Peak Current	30	A
I_B	Base Current	4	A
I_{BM}	Base Peak Current	6	A
P_{base}	Reverse Bias Base Dissipation (B.E. junction in avalanche)	1	W
P_{tot}	Total Dissipation at $T_c < 25^\circ C$	150	W
T_{stg}	Storage Temperature	- 65 to 200	$^\circ C$
T_j	Max. Operating Junction Temperature	200	$^\circ C$

THERMAL DATA

$R_{thj-case}$	Thermal Resistance Junction-case	Max	1.17	°C/W
----------------	----------------------------------	-----	------	------

ELECTRICAL CHARACTERISTIC($T_{case} = 25^{\circ}C$ unless otherwise Specified)

Symbol	Parameter	Test Conditions	Min.	Typ.	Max.	Unit
I_{CER}	Collector Cutoff Current ($R_{BE} = 10\Omega$)	$V_{CE} = V_{CEV}$			0.5	mA
		$V_{CE} = V_{CEV} \quad T_c = 100^{\circ}C$			2.5	mA
I_{CEV}	Collector Cutoff Current	$V_{CE} = V_{CEV} \quad V_{BE} = -1.5V$			0.5	mA
		$V_{CE} = V_{CEV} \quad V_{BE} = -1.5V \quad T_c = 100^{\circ}C$			2	mA
I_{EBO}	Emitter Cutoff Current ($I_C = 0$)	$V_{EB} = 5V$			1	mA
$V_{CEO(sus)}^*$	Collector Emitter Sustaining Voltage	$I_C = 0.2A$ $L = 25mH$	250			V
V_{EBO}	Emitter-base Voltage ($I_C = 0$)	$I_E = 50mA$	7			V
$V_{CE(sat)}^*$	Collector-emitter Saturation Voltage	$I_C = 4A \quad I_B = 0.27A$		0.35	0.8	V
		$I_C = 8A \quad I_B = 0.8A$		0.45	0.9	V
		$I_C = 12A \quad I_B = 1.5A$		0.6	1.2	V
		$I_C = 4A \quad I_B = 0.27A \quad T_j = 100^{\circ}C$		0.35	0.9	V
		$I_C = 8A \quad I_B = 0.8A \quad T_j = 100^{\circ}C$		0.6	1.5	V
		$I_C = 12A \quad I_B = 1.5A \quad T_j = 100^{\circ}C$		0.9	1.9	V
$V_{BE(sat)}^*$	Base-emitter Saturation Voltage	$I_C = 8A \quad I_B = 0.8A$		1	1.3	V
		$I_C = 12A \quad I_B = 1.5A$		1.2	1.5	V
		$I_C = 8A \quad I_B = 0.8A \quad T_j = 100^{\circ}C$		0.9	1.3	V
		$I_C = 12A \quad I_B = 1.5A \quad T_j = 100^{\circ}C$		1.2	1.5	V
di_C/dt	Rated of Rise of On-state Collector Current	$V_{CC} = 200V \quad R_C = 0 \quad I_{B1} = 1.2A$				
		See fig. 2		30 25	70 60	
$V_{CE(2\mu s)}$	Collector Emitter Dynamic Voltage	$V_{CC} = 200V$				
		$R_C = 25\Omega$ See fig. 2	$I_{B1} = 0.8A$ $T_j = 25^{\circ}C$ $T_j = 100^{\circ}C$		1.8 2.8	3 5
$V_{CE(4\mu s)}$	Collector Emitter Dynamic Voltage	$V_{CC} = 200V$				
		$R_C = 25\Omega$ See fig. 2	$I_{B1} = 0.8A$ $T_j = 25^{\circ}C$ $T_j = 100^{\circ}C$		1.1 1.5	1.7 2.5

ELECTRICAL CHARACTERISTIC(continued)

RESISTIVE LOAD

Symbol	Parameter	Test Conditions	Min.	Typ.	Max.	Unit
t_r	Rise Time	$V_{CC} = 200V$ $I_C = 12A$		0.3	0.6	μs
t_s	Storage Time	$V_{BB} = -5V$ $I_{B2} = 1.5A$		1	1.6	μs
t_f	Fall Time	$R_{B2} = 1.7\Omega$ $t_p = 30\mu s$ See fig. 1		0.15	0.3	μs

INDUCTIVE LOAD

Symbol	Parameter	Test Conditions	Min.	Typ.	Max.	Unit
t_s	Storage Time	$V_{CC} = 200V$ $I_C = 8A$		1.2	1.8	μs
t_f	Fall Time	$V_{clamp} = 250V$ $I_B = 0.8A$		0.08	0.2	μs
t_t	Tail Time in Turn-on	$V_{BB} = -5V$ $R_{B2} = 3.1\Omega$		0.03	0.12	μs
t_c	Crossover Time	$L_C = 1.3mH$ See fig. 3		0.15	0.35	μs
t_s	Storage Time	$V_{CC} = 200V$ $I_C = 8A$		1.8	2.4	μs
t_f	Fall Time	$V_{clamp} = 250V$ $I_B = 0.8A$		0.2	0.4	μs
t_t	Tail Time in Turn-on	$V_{BB} = -5V$ $R_{B2} = 3.1\Omega$		0.08	0.2	μs
t_c	Crossover Time	$L_C = 1.3mH$ $T_J = 100^\circ C$ See fig. 3		0.35	0.7	μs
t_s	Storage Time	$V_{CC} = 200V$ $I_C = 8A$		2.8		μs
t_f	Fall Time	$V_{clamp} = 250V$ $I_B = 0.8A$		0.5		μs
t_t	Tail Time in Turn-on	$V_{BB} = 0$ $R_{B2} = 5.6\Omega$ $L_C = 1.3mH$ See fig. 3		0.15		μs
t_s	Storage Time	$V_{CC} = 200V$ $I_C = 8A$		4.5		μs
t_f	Fall Time	$V_{clamp} = 250V$ $I_B = 0.8A$		0.8		μs
t_t	Tail Time in Turn-on	$V_{BB} = 0$ $R_{B2} = 5.6\Omega$ $L_C = 1.3mH$ See fig. 3		0.4		μs

* Pulsed : Pulse duration = 300 μs , duty cycle = 2%.

Figure 1 : Switching Times Test Circuit (resistive load).

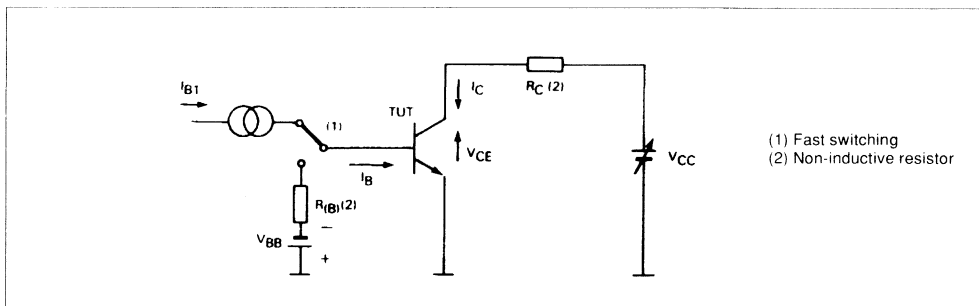

Figure 2 : Turn-on Switching Waveforms.

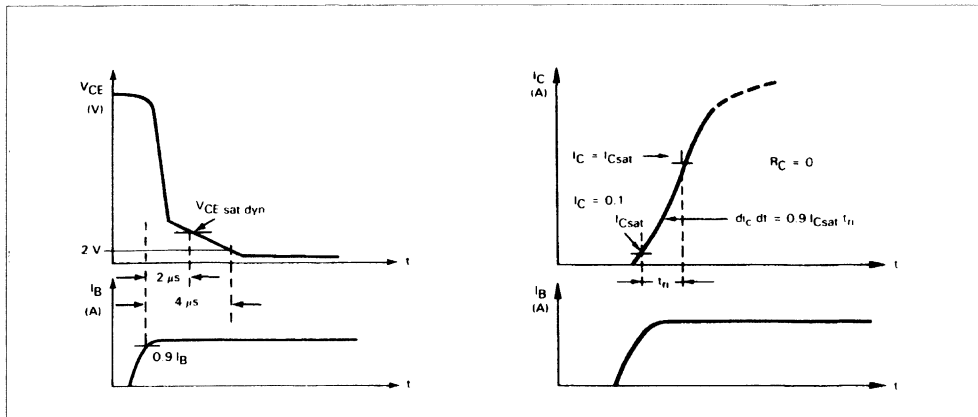

Figure 3a : Turn-on Switching Test Circuits.

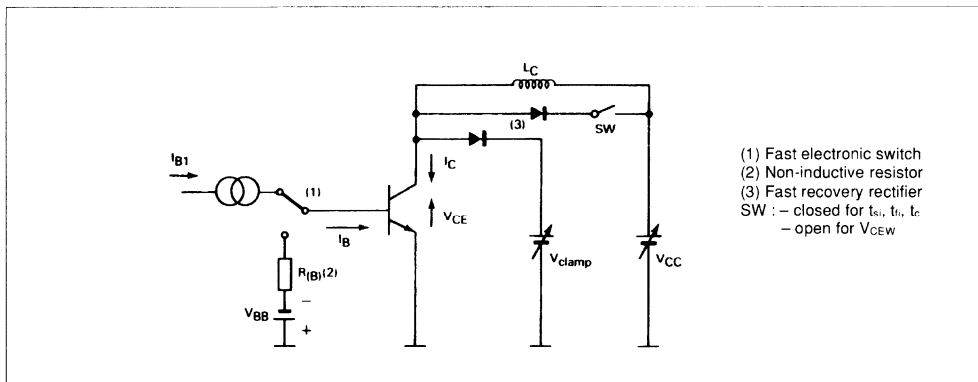
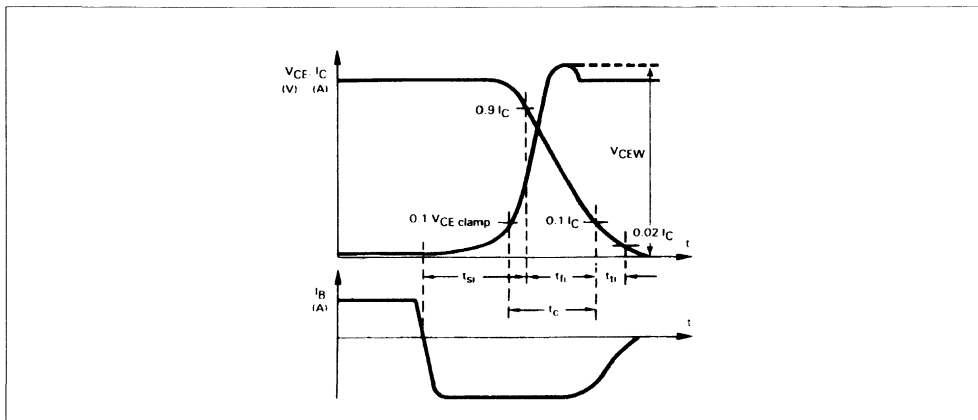
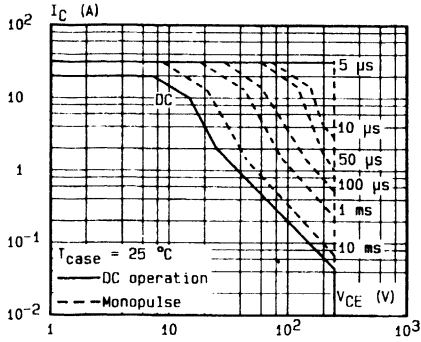

Figure 3b : Turn-on Switching Waveforms (inductive load).



DC and AC Pulse Area.



Power and $I_{S/B}$ Derating versus Case Temperature.

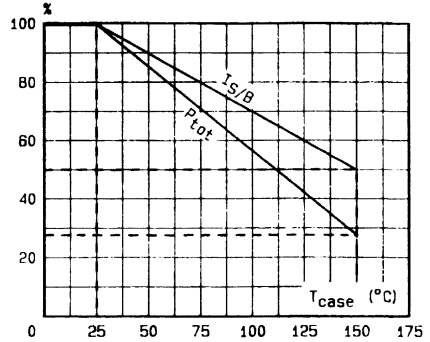

Transient Thermal Response.

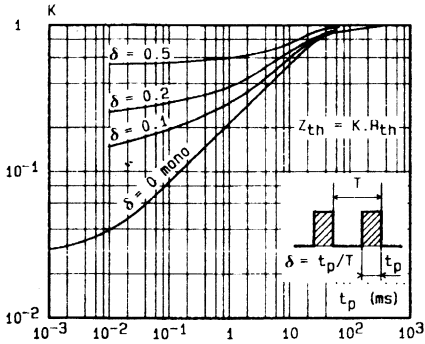

Collector-emitter Voltage versus Base-emitter Resistance.

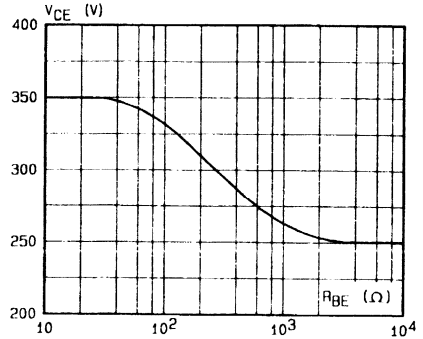

DC Current Gain.

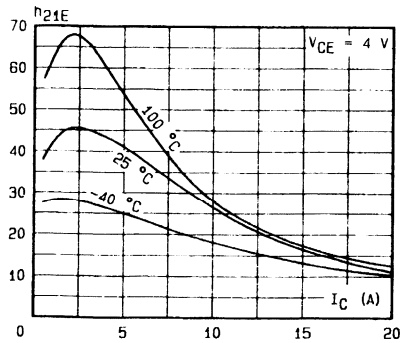

Minimum Base Current to Saturate the transistor.

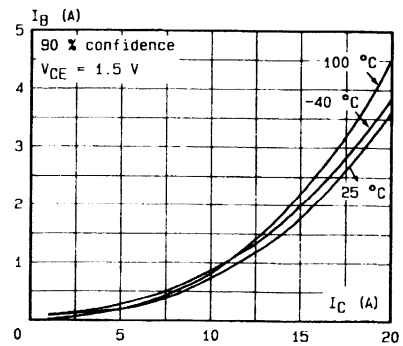

Saturation Voltage.

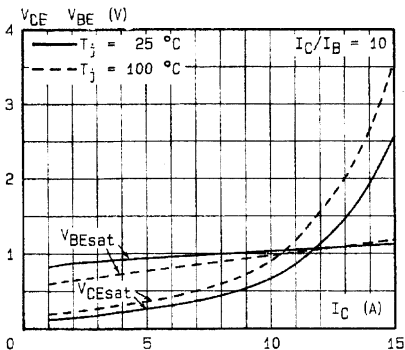

Saturation Voltage.

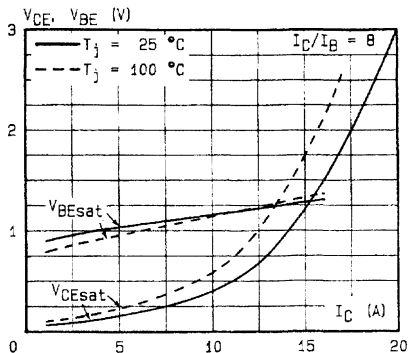

Switching Times versus Collector Current (resistive load).

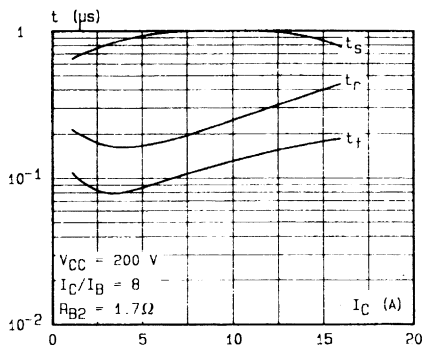

Switching Times versus Collector Current (inductive load).

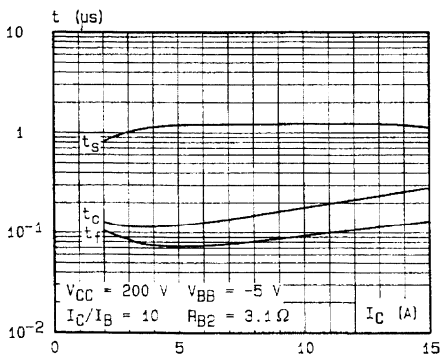

Switching Times versus Collector Current (inductive load).

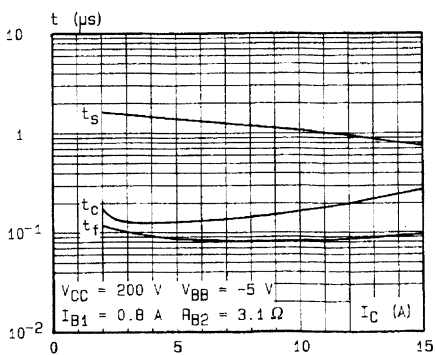

SWITCHING OPERATING AND OVERLOAD AREAS

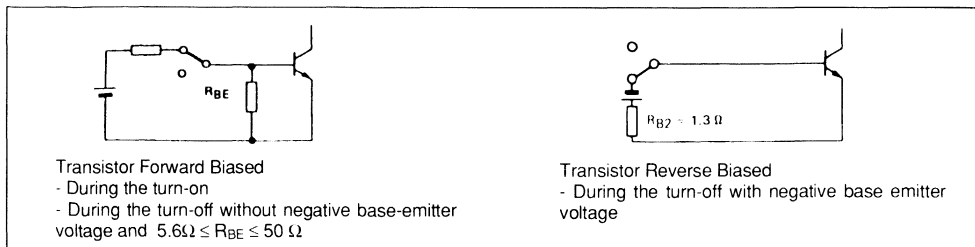

Forward Biased Safe Operating Area (FBSOA).

Reverse Biased Safe Operating Area (RBSOA).

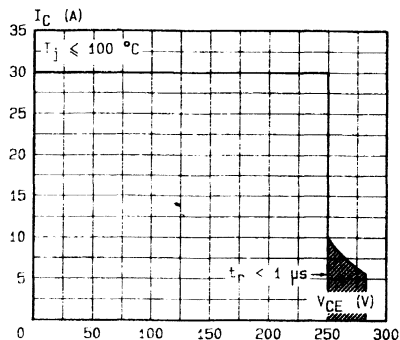

The hatched zone can only be used for turn-on.

Forward Biased Accidental Overload Area (FBAOA).

Reverse Biased Accidental Overload Area (RBAOA).

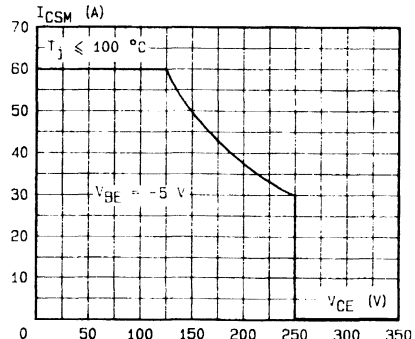
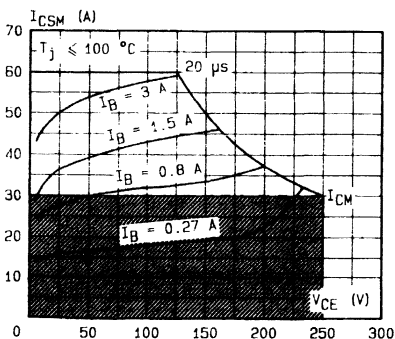
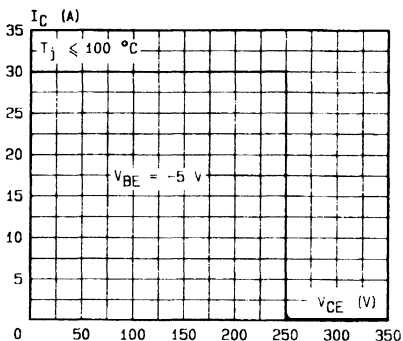

The Kellogg network (heavy point) allows the calculation of the maximum value of the short-circuit for a given base current I_B (90 % confidence).

After the accidental overload current the RBAOA has to be used for the turn-off.

High accidental surge currents (I_{ICM}) are allowed if they are non repetitive and applied less than 3000 times during the component life.

FAST SWITCHING POWER TRANSISTOR

- FAST SWITCHING TIMES
- LOW SWITCHING LOSSES
- LOW BASE CURRENT REQUIREMENTS
- VERY LOW SATURATION VOLTAGE AND HIGH GAIN

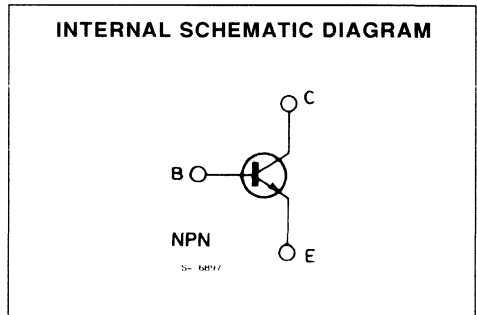
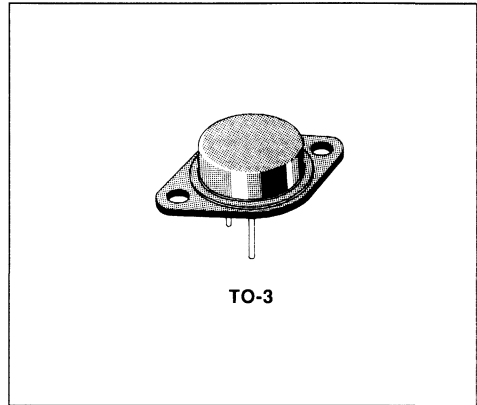
ABSOLUTE MAXIMUM RATINGS

Symbol	Parameter	Value	Unit
V_{CEV}	Collector-emitter Voltage ($V_{BE} = -1.5V$)	400	V
V_{CEO}	Collector-emitter Voltage ($I_B = 0$)	300	V
V_{EBO}	Emitter-base Voltage ($I_C = 0$)	7	V
I_C	Collector Current	20	A
I_{CM}	Collector Peak Current	30	A
I_B	Base Current	4	A
I_{BM}	Base Peak Current	6	A
P_{tot}	Total Dissipation at $T_c < 25^\circ C$	150	W
T_{stg}	Storage Temperature	- 65 to 200	$^\circ C$
T_j	Max. Operating Junction Temperature	200	$^\circ C$

THERMAL DATA

$R_{th(j-case)}$	Thermal Resistance Junction-case	Max	1.17	°
------------------	----------------------------------	-----	------	---

ELECTRICAL CHARACTERISTICS ($T_{case} = 25^{\circ}C$ unless otherwise specified)

Symbol	Parameter	Test Conditions	Min.	Typ.	Max.	Unit
I_{CER}	Collector Cutoff Current ($R_{BE} = 10\Omega$)	$V_{CE} = V_{CEV}$			0.5	mA
		$V_{CE} = V_{CEV} \quad T_c = 100^{\circ}C$			2.5	mA
I_{CEV}	Collector Cutoff Current	$V_{CE} = V_{CEV} \quad V_{BE} = -1.5V$ $V_{CE} = V_{CEV} \quad V_{BE} = -1.5V \quad T_c = 100^{\circ}C$			0.5 2	mA mA
I_{EBO}	Emitter Cutoff Current ($I_C = 0$)	$V_{EB} = 5V$			1	mA
$V_{CEO(sus)}^*$	Collector Emitter Sustaining Voltage	$I_C = 0.2A$ $L = 25mH$	300			V
V_{EBO}	Emitter-base Voltage ($I_C = 0$)	$I_E = 50mA$	7			V
$V_{CE(sat)}^*$	Collector-emitter Saturation Voltage	$I_C = 7A \quad I_B = 0.7A$			0.9	V
		$I_C = 7A \quad I_B = 0.7A \quad T_j = 100^{\circ}C$			1.9	V
$V_{BE(sat)}^*$	Base-emitter Saturation Voltage	$I_C = 7A \quad I_B = 0.7A$			1.3	V
		$I_C = 7A \quad I_B = 0.7A \quad T_j = 100^{\circ}C$			1.3	V
di_c/dt	Rate of Rise of On-state Collector Current	$V_{CC} = 250V \quad R_C = 0$ $t_p = 3\mu s$ See fig. 1	40			A/ μs

INDUCTIVE LOAD

Symbol	Parameter	Test Conditions	Min.	Typ.	Max.	Unit
t_s	Storage Time	$V_{CC} = 250V \quad V_{clamp} = 300V$ $I_C = 7A \quad I_B = 0.7A$ $V_{BB} = -5V \quad R_{B2} = 3.6\Omega$ $L_C = 1.8mH \quad T_j = 100^{\circ}C$ see fig. 2			3	μs
t_f	Fall Time				0.4	μs
t_c	Crossover Time				0.7	μs
V_{CEW}	Maximum Collector Emitter Voltage without Snubber	$V_{CC} = 50V \quad I_{CW0H} = 10A$ $V_{BB} = -5V \quad I_{B1} = 0.7A$ $L_C = 0.25mH \quad R_{BB} = 3.6\Omega$ $T_j = 125^{\circ}C$ See fig. 2	300			V

Figure 1 : Turn-on Switching Characteristics of the Transistor.

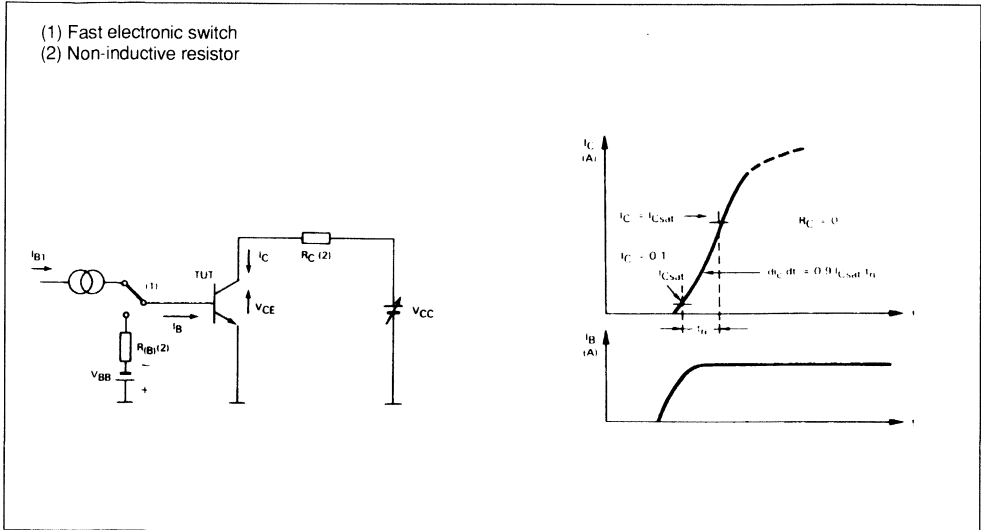
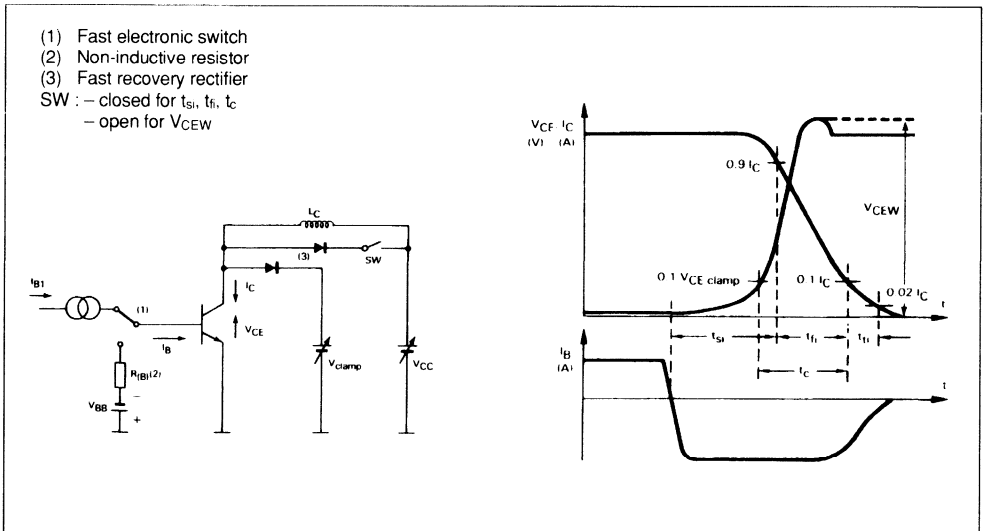
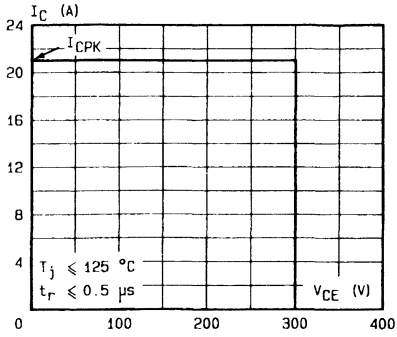

Figure 2 : Turn-off Switching Characteristics of the Transistor.



Forward Biased Safe Operating Area (FBSOA).



Reverse Biased Safe Operating Area (RBSOA).

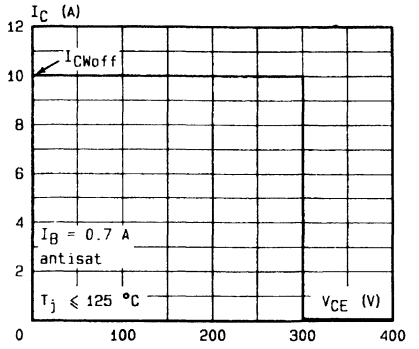

FAST SWITCHING POWER TRANSISTOR

- SUITABLE FOR SWITCH MODE POWER SUPPLY, UPS, DC AND AC MOTOR CONTROL

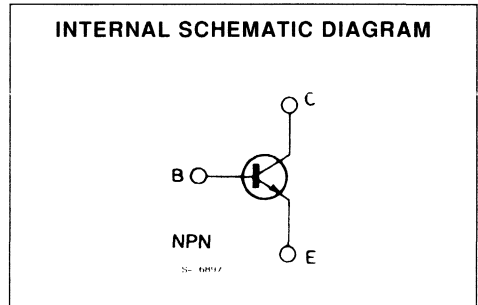
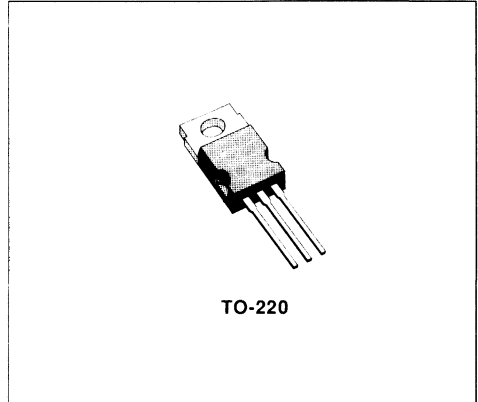

DESCRIPTION

High voltage, high speed transistor suited for use on the 220 and 380V mains.

ABSOLUTE MAXIMUM RATINGS

Symbol	Parameter	Value	Unit
V_{CEV}	Collector-emitter Voltage ($V_{BE} = -1.5V$)	850	V
V_{CEO}	Collector-emitter Voltage ($I_B = 0$)	450	V
V_{EBO}	Emitter-base Voltage ($I_C = 0$)	7	V
I_C	Collector Current	9	A
I_{CM}	Collector Peak Current	14	A
I_B	Base Current	3	A
I_{BM}	Base Peak Current	4.5	A
P_{tot}	Total Dissipation at $T_c < 25^\circ C$	70	W
T_{stg}	Storage Temperature	- 65 to 150	$^\circ C$
T_j	Max. Operating Junction Temperature	150	$^\circ C$

THERMAL DATA

$R_{\theta J-case}$	Thermal Resistance Junction-case	Max	1.76	$^{\circ}C/W$
---------------------	----------------------------------	-----	------	---------------

ELECTRICAL CHARACTERISTICS($T_{case} = 25^{\circ}C$ unless otherwise specified)

Symbol	Parameter	Test Conditions	Min.	Typ.	Max.	Unit
I_{CER}	Collector Cutoff Current ($R_{BE} = 10\Omega$)	$V_{CE} = V_{CEV}$ $V_{CE} = V_{CEV}$ $T_C = 100^{\circ}C$			0.2 1.5	mA mA
I_{CEV}	Collector Cutoff Current	$V_{CE} = V_{CEV}$ $V_{BE} = -1.5V$ $V_{CE} = V_{CEV}$ $V_{BE} = -1.5V$ $T_C = 100^{\circ}C$			0.2 1.5	mA mA
I_{EBO}	Emitter Cutoff Current ($I_C = 0$)	$V_{EB} = 5V$			1	mA
$V_{CEO(sus)}$ *	Collector Emitter Sustaining Voltage	$I_C = 0.2A$ $L = 25mH$	450			V
V_{EBO}	Emitter-base Voltage ($I_C = 0$)	$I_E = 50mA$	7			V
$V_{CE(sat)}$ *	Collector-emitter Saturation Voltage	$I_C = 5A$ $I_B = 1A$ $I_C = 5A$ $I_B = 1A$ $T_J = 100^{\circ}C$			1.2 2	V V
$V_{BE(sat)}$ *	Base-emitter Saturation Voltage	$I_C = 5A$ $I_B = 1A$ $I_C = 5A$ $I_B = 1A$ $T_J = 100^{\circ}C$			1.3 1.3	V V
di_c/dt	Rated of Rise of on-state Collector Current	$V_{CC} = 300V$ $R_C = 0$ $I_{B1} = 1.5A$ $t_p = 3\mu s$ $T_J = 100^{\circ}C$ See fig. 1	45			A/ μs

INDUCTIVE LOAD

Symbol	Parameter	Test Conditions	Min.	Typ.	Max.	Unit
t_s	Storage Time	$V_{CC} = 400V$ $V_{clamp} = 450V$			3	μs
t_f	Fall Time	$I_C = 5A$ $I_B = 1A$			0.4	μs
t_c	Crossover Time	$V_{BB} = -5V$ $R_{BB} = 2.5\Omega$ $L_C = 4mH$ $T_J = 100^{\circ}C$ See fig.2			0.7	μs
V_{CEW}	Maximum Collector Emitter Voltage without Snubber	$V_{CC} = 50V$ $I_{Cwoff} = 7.5A$ $V_{BB} = -5V$ $I_{B1} = 1A$ $L_C = 0.33mH$ $R_{BB} = 2.5\Omega$ $T_J = 125^{\circ}C$ See fig.2	450			V

Figure 1 : Turn-on Switching Characteristics of the Transistor.

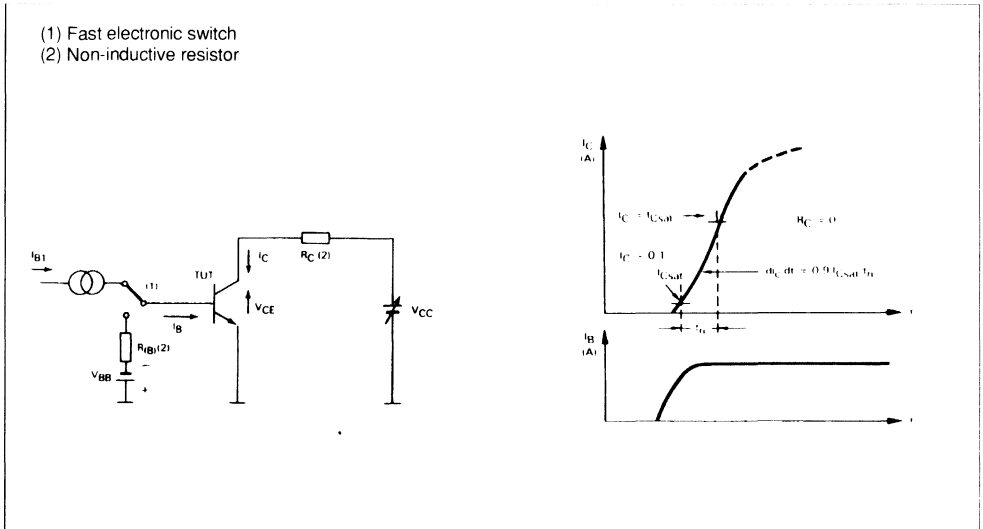
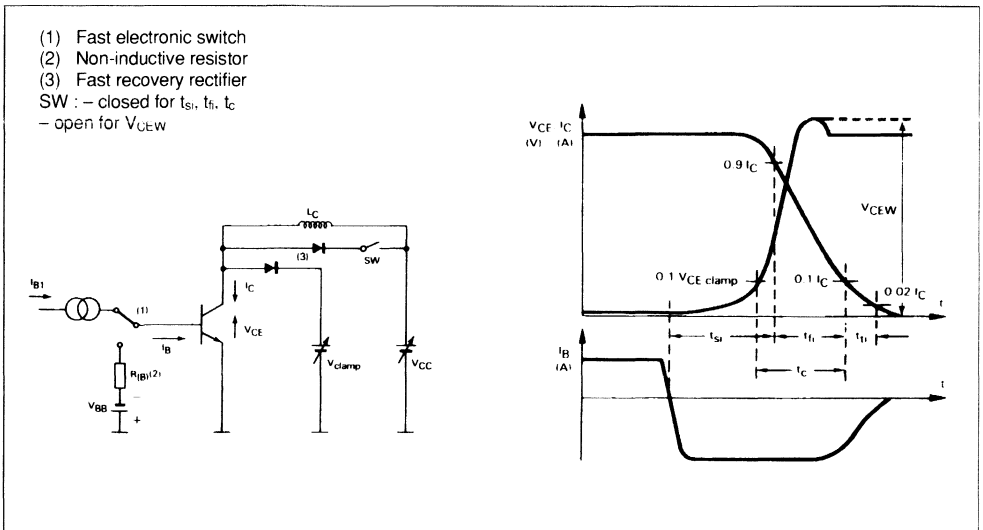
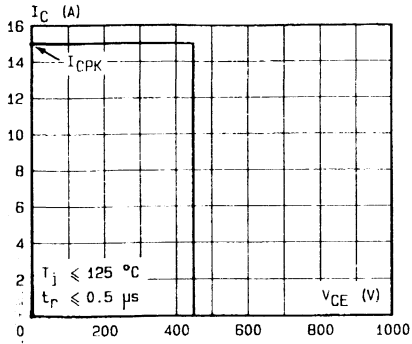

Figure 2 : Turn-off Switching Characteristics of the Transistor.



Forward Biased Safe Operating Area (FBSOA).



Reverse Biased Safe Operating Area (RBSOA).

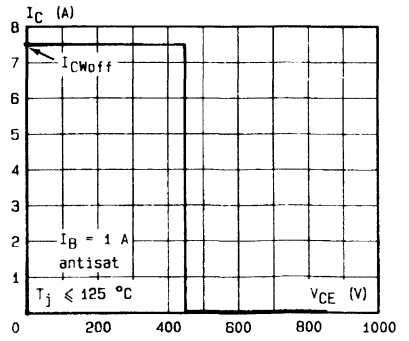

FAST SWITCHING POWER TRANSISTOR

- FAST SWITCHING TIMES
- LOW SWITCHING LOSSES
- VERY LOW SATURATION VOLTAGE AND HIGH GAIN FOR REDUCED LOAD OPERATION

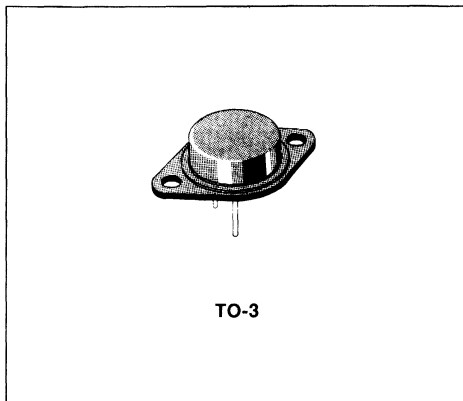

INTERNAL SCHEMATIC DIAGRAM

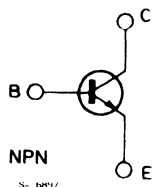

ABSOLUTE MAXIMUM RATINGS

Symbol	Parameter	Value	Unit
V_{CEV}	Collector-emitter Voltage ($V_{BE} = -1.5V$)	250	V
V_{CEO}	Collector-emitter Voltage ($I_B = 0$)	125	V
V_{EBO}	Emitter-base Voltage ($I_C = 0$)	7	V
I_C	Collector Current	50	A
I_{CM}	Collector Peak Current	80	A
I_B	Base Current	10	A
I_{BM}	Base Peak Current	18	A
P_{base}	Reverse Bias Base Dissipation (B.E. junction in avalanche)	3	W
P_{tot}	Total Dissipation at $T_c < 25^\circ C$	250	W
T_{stg}	Storage Temperature	- 65 to 200	$^\circ C$
T_j	Max. Operating Junction Temperature	200	$^\circ C$

THERMAL DATA

$R_{thj-case}$	Thermal Resistance Junction-case	Max	0.7	°C/W
----------------	----------------------------------	-----	-----	------

ELECTRICAL CHARACTERISTICS ($T_{case} = 25^{\circ}C$ unless otherwise specified)

Symbol	Parameter	Test Conditions	Min.	Typ.	Max.	Unit	
I_{CER}	Collector Cutoff Current ($R_{BE} = 10\Omega$)	$V_{CE} = V_{CEV}$ $V_{CE} = V_{CEV}$ $T_c = 100^{\circ}C$			1 5	mA mA	
I_{CEV}	Collector Cutoff Current	$V_{CE} = V_{CEV}$ $V_{BE} = -1.5V$ $V_{CE} = V_{CEV}$ $V_{BE} = -1.5V$ $T_c = 100^{\circ}C$			1 4	mA mA	
I_{EBO}	Emitter Cutoff Current ($I_C = 0$)	$V_{EB} = 5V$			1	mA	
$V_{CEO(sus)}^*$	Collector Emitter Sustaining Voltage	$I_C = 0.2A$ $L = 25mH$	125			V	
V_{EBO}	Emitter-base Voltage ($I_C = 0$)	$I_E = 50mA$	7			V	
$V_{CE(sat)}^*$	Collector-emitter Saturation Voltage	$I_C = 25A$ $I_B = 1.25A$ $I_C = 50A$ $I_B = 5A$ $I_C = 60A$ $I_B = 7.5A$ $I_C = 25A$ $I_B = 1.25A$ $T_j = 100^{\circ}C$ $I_C = 50A$ $I_B = 5A$ $T_j = 100^{\circ}C$ $I_C = 60A$ $I_B = 7.5A$ $T_j = 100^{\circ}C$		0.45 0.65 0.75 0.45 0.7 0.9	0.9 0.9 1.2 1.2 1.5 1.8	V V V V V V	
$V_{BE(sat)}^*$	Base-emitter Saturation Voltage	$I_C = 50A$ $I_B = 5A$ $I_C = 60A$ $I_B = 7.5A$ $I_C = 50A$ $I_B = 5A$ $T_j = 100^{\circ}C$ $I_C = 60A$ $I_B = 7.5A$ $T_j = 100^{\circ}C$		1.4 1.55 1.45 1.65	1.6 1.8 1.7 1.9	V V V V	
di_C/dt	Rated of Rise of On-state Collector Current	$V_{CC} = 100V$ $R_C = 0$ See fig. 2		100 90	160 150	A/ μs A/ μs	
$V_{CE(2\mu s)}$	Collector-emitter Dynamic Voltage	$V_{CC} = 100V$ $R_C = 2\Omega$ See fig. 2			2.5 3	3 4.5	V V
$V_{CE(4\mu s)}$	Collector-emitter Dynamic Voltage	$V_{CC} = 100V$ $R_C = 2\Omega$ See fig. 2			1.8 1.9	2.2 3	V V

RESISTIVE LOAD

Symbol	Parameter	Test Conditions	Min.	Typ.	Max.	Unit
t_r	Rise Time	$V_{CC} = 100V$ $I_C = 60A$		0.5	0.8	μs
t_s	Storage Time	$V_{BB} = -5V$ $I_{B1} = 7.5A$		0.6	1.1	μs
t_f	Fall Time	$R_B = 0.33\Omega$ $t_p = 30\mu s$ See fig. 1		0.06	0.2	μs

ELECTRICAL CHARACTERISTICS (continued)

INDUCTIVE LOAD

Symbol	Parameter	Test Conditions		Min.	Typ.	Max.	Unit
t_s	Storage Time	$V_{CC} = 100V$	$V_{clamp} = 125V$		0.5	1.2	μs
t_f	Fall Time	$I_C = 50A$	$I_B = 5A$		0.05	0.15	μs
t_{ft}	Tail Time in Turn-on	$V_{BB} = -5V$	$R_{B2} = 0.5\Omega$		0.01	0.05	μs
t_c	Crossover Time	$L_C = 0.1mH$	see fig. 3		0.1	0.3	μs
t_s	Storage Time	$V_{CC} = 100V$	$V_{clamp} = 125V$		0.85	1.5	μs
t_f	Fall Time	$I_C = 50A$	$I_B = 5A$		0.12	0.25	μs
t_{ft}	Tail Time in Turn-on	$V_{BB} = -5V$	$R_{B2} = 0.5\Omega$		0.04	0.1	μs
t_c	Crossover Time	$L_C = 0.1mH$ see fig. 3	$T_j = 100^\circ C$		0.2	0.5	μs
t_s	Storage Time	$V_{CC} = 100V$	$V_{clamp} = 125V$		1.5		μs
t_f	Fall Time	$I_C = 50A$	$I_B = 5A$		1.3		μs
t_t	Tail Time in Turn-on	$V_{BB} = 0$ $L_C = 0.1mH$ see fig. 3	$R_{B2} = 1.5\Omega$ see fig. 3		0.4		μs
t_s	Storage Time	$V_{CC} = 100V$	$V_{clamp} = 125V$		2.7		μs
t_f	Fall Time	$I_C = 50A$	$I_B = 5A$		1.8		μs
t_t	Tail Time in Turn-on	$V_{BB} = 0$ $L_C = 0.1mH$ see fig. 3	$R_{B2} = 1.5\Omega$ $T_j = 100^\circ C$		0.6		μs

* Pulsed : Pulse duration = 300 μs . duty cycle = 2%.

Figure 1 : Switching Times Test Circuit (resistive load).

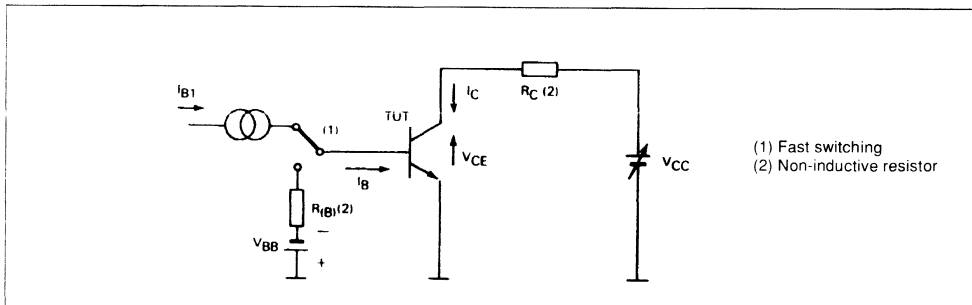

Figure 2 : Turn-on Switching Waveforms.

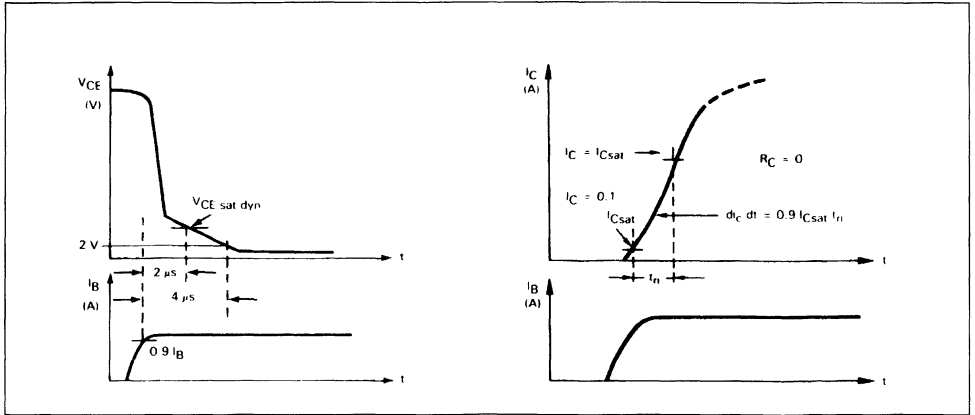

Figure 3a : Turn-off Switching Test Circuit.

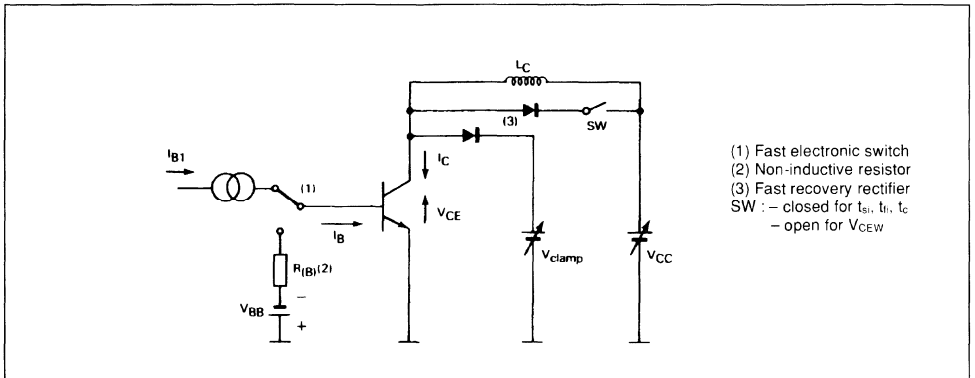
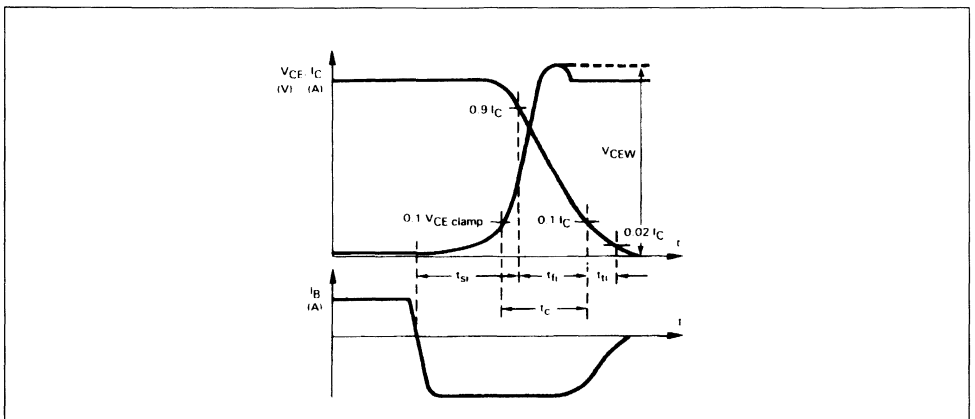
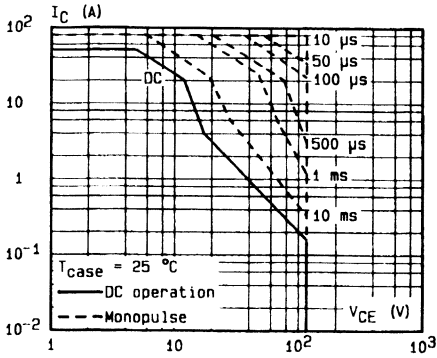

Figure 3b : Turn-off Switching Waveforms (inductive load).



DC and AC Pulse Area.



Power and $I_{S/B}$ Derating versus Case Temperature.

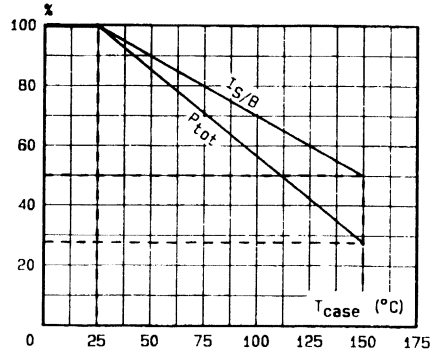

Transient Thermal Response.

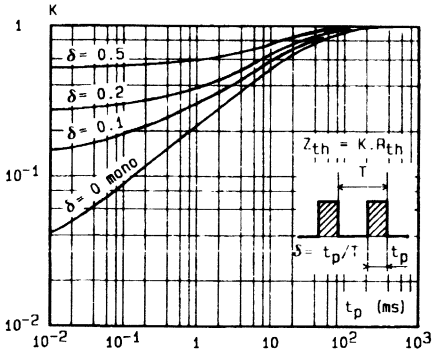

Collector-emitter Voltage versus Base-emitter Resistance.

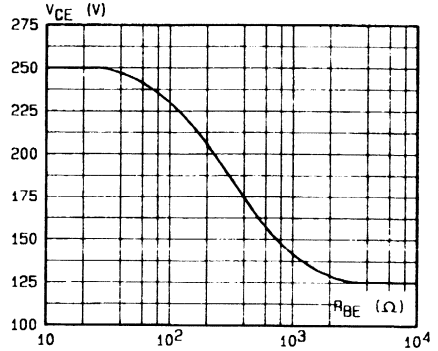

DC Current Gain.

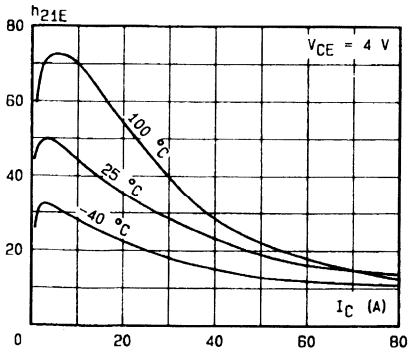

Minimum Base Current to saturate the Transistor.

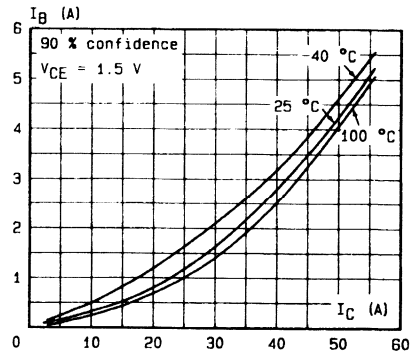

Saturation Voltage.

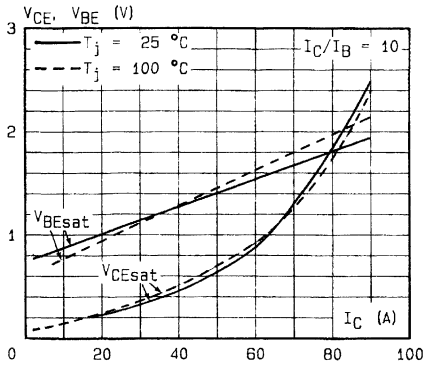

Saturation Voltage.

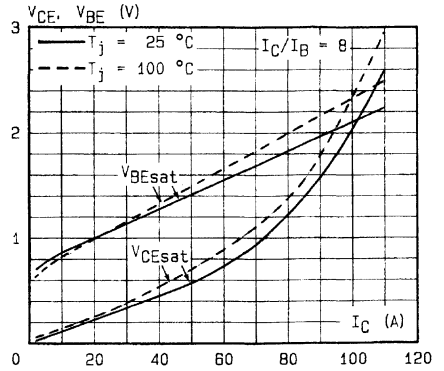

Switching Times versus Collector Current (resistive load).

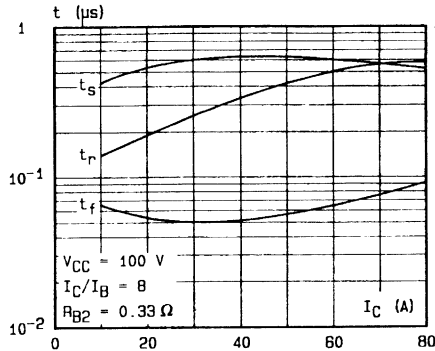

Switching Times versus Collector Current (inductive load).

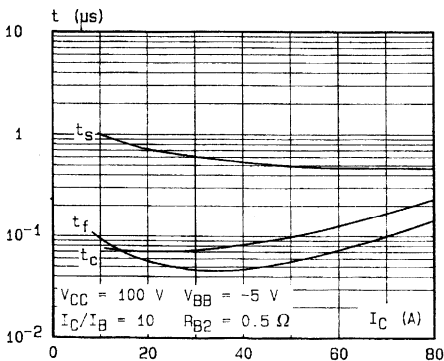

Switching Times versus Collector Current (inductive load).

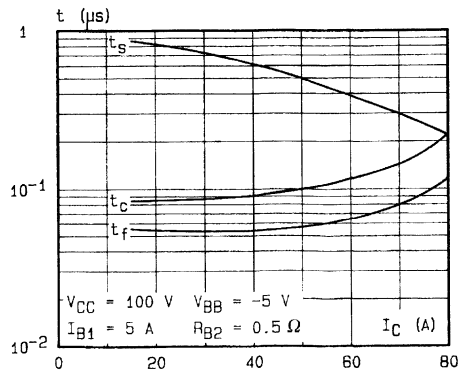

SWITCHING OPERATING AND OVERLOAD AREAS

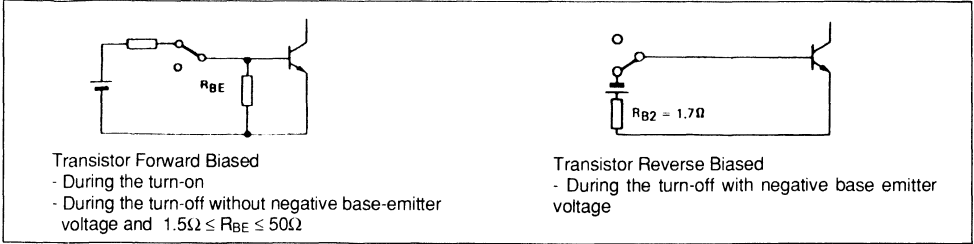

Forward Biased Safe Operating Area (FBSOA).

Reverse Biased Safe Operating Area (RBSOA).

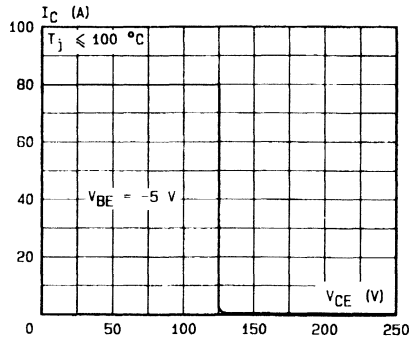
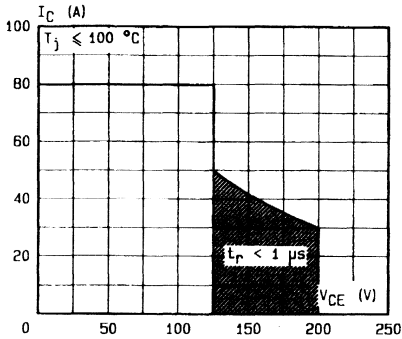

The hatched zone can only be used for turn-on.

Forward Biased Accidental Overload Area (FBAOA).

Reverse Biased Accidental Overload Area (RBAOA).

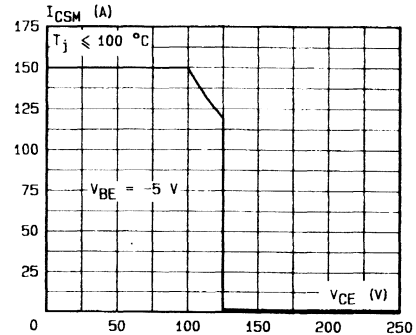
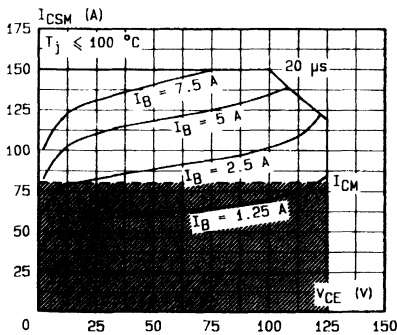

The Kellogg network (heavy point) allows the calculation of the maximum value of the short-circuit for a given base current I_B (90 % confidence).

After the accidental overload current the RBAOA has to be used for the turn-off.

High accidental surge currents (I_{CM}) are allowed if they are non repetitive and applied less than 3000 times during the component life.

FAST SWITCHING POWER TRANSISTOR

- FAST SWITCHING TIMES
- LOW SWITCHING LOSSES
- VERY LOW SATURATION VOLTAGE AND HIGH GAIN FOR REDUCED LOAD OPERATION

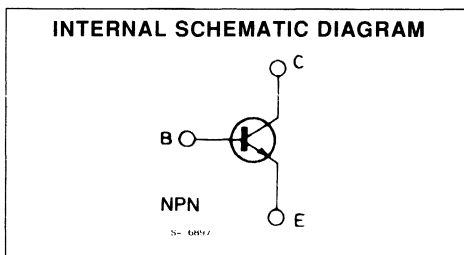
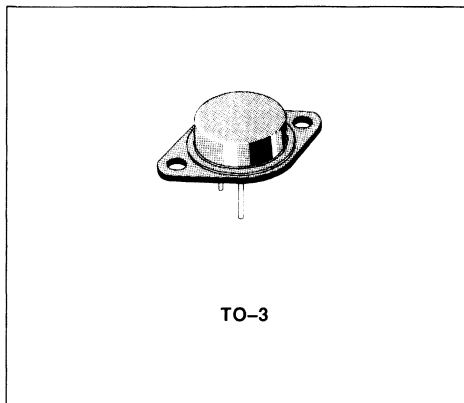

ABSOLUTE MAXIMUM RATINGS

Symbol	Parameter	Value	Unit
V_{CEV}	Collector-emitter Voltage ($V_{BE} = -1.5V$)	300	V
V_{CEO}	Collector-emitter Voltage ($I_B = 0$)	200	V
V_{EBO}	Emitter-base Voltage ($I_C = 0$)	7	V
I_C	Collector Current	50	A
I_{CM}	Collector Peak Current	75	A
I_B	Base Current	8	A
I_{BM}	Base Peak Current	15	A
P_{base}	Reverse Bias Base Dissipation (B.E. junction in avalanche)	2	W
P_{tot}	Total Dissipation at $T_C < 25^\circ C$	250	W
T_{stg}	Storage Temperature	- 65 to 200	$^\circ C$
T_J	Max. Operating Junction Temperature	200	$^\circ C$

THERMAL DATA

$R_{th\ j-case}$	Thermal Resistance Junction-case	Max	0.7	°C/W
------------------	----------------------------------	-----	-----	------

ELECTRICAL CHARACTERISTICS ($T_{case} = 25^{\circ}C$ unless otherwise specified)

Symbol	Parameter	Test Conditions	Min.	Typ.	Max.	Unit	
I_{CER}	Collector Cutoff Current ($R_{BE} = 10\Omega$)	$V_{CE} = V_{CEV}$ $V_{CE} = V_{CEV}$ $T_C = 100^{\circ}C$			1 5	mA mA	
I_{CEV}	Collector Cutoff Current	$V_{CE} = V_{CEV}$ $V_{BE} = -1.5V$ $V_{CE} = V_{CEV}$ $V_{BE} = -1.5V$ $T_C = 100^{\circ}C$			1 4	mA mA	
I_{EBO}	Emitter Cutoff Current ($I_C = 0$)	$V_{EB} = 5V$			1	mA	
$V_{CEO(sus)}^*$	Collector Emitter Sustaining Voltage	$I_C = 0.2A$ $L = 25mH$	200			V	
V_{EBO}	Emitter-base Voltage ($I_C = 0$)	$I_E = 50mA$	7			V	
$V_{CE(sat)}^*$	Collector-emitter Saturation Voltage	$I_C = 12.5A$ $I_B = 0.625A$ $I_C = 25A$ $I_B = 2.5A$ $I_C = 40A$ $I_B = 5A$ $I_C = 12.5A$ $I_B = 0.625A$ $T_j = 100^{\circ}C$ $I_C = 25A$ $I_B = 2.5A$ $T_j = 100^{\circ}C$ $I_C = 40A$ $I_B = 5A$ $T_j = 100^{\circ}C$		0.65 0.4 0.6 0.5 0.5 0.75	0.9 0.9 1.2 1.2 1.5 1.9	V V V V V V	
$V_{BE(sat)}^*$	Base-emitter Saturation Voltage	$I_C = 25A$ $I_B = 2.5A$ $I_C = 40A$ $I_B = 5A$ $I_C = 25A$ $I_B = 2.5A$ $T_j = 100^{\circ}C$ $I_C = 40A$ $I_B = 5A$ $T_j = 100^{\circ}C$		1.05 1.35 1.1 1.35	1.4 1.8 1.7 1.8	V V V V	
di_C/dt	Rated of Rise of on-state Collector Current	$V_{CC} = 160V$ $R_C = 0$ See fig. 2	$I_{B1} = 3.75A$ $T_j = 25^{\circ}C$ $T_j = 100^{\circ}C$	70 60	130 110	A/ μs A/ μs	
$V_{CE(2\mu s)}$	Collector Emitter Dynamic Voltage	$V_{CC} = 160V$ $R_C = 6.4\Omega$ See fig. 2	$I_{B1} = 2.5A$ $T_j = 25^{\circ}C$ $T_j = 100^{\circ}C$		1.3 1.8	3 5	V V
$V_{CE(4\mu s)}$	Collector Emitter Dynamic Voltage	$V_{CC} = 160V$ $R_C = 6.4\Omega$ See fig. 2	$I_{B1} = 2.5A$ $T_j = 25^{\circ}C$ $T_j = 100^{\circ}C$		0.95 1.1	2 3	V V

RESISTIVE LOAD

Symbol	Parameter	Test Conditions	Min.	Typ.	Max.	Unit
t_r	Rise Time	$V_{CC} = 160V$		0.55	0.7	μs
t_s	Storage Time	$V_{BB} = -5V$		0.6	1.2	μs
t_f	Fall Time	$R_{B2} = 0.5\Omega$ See fig. 1		0.07	0.3	μs

ELECTRICAL CHARACTERISTICS (continued)

INDUCTIVE LOAD

Symbol	Parameter	Test Conditions		Min.	Typ.	Max.	Unit
t_s	Storage Time	$V_{CC} = 160V$	$V_{clamp} = 200V$		0.85	1.9	μs
t_f	Fall time	$I_C = 25A$	$I_B = 2.5A$		0.06	0.15	μs
t_t	Tail Time in Turn-on	$V_{BB} = -5V$	$R_{B2} = 1\Omega$		0.01	0.07	μs
t_c	Crossover Time	$L_C = 0.32mH$	See fig. 3		0.11	0.3	μs
t_s	Storage Time	$V_{CC} = 160V$	$V_{clamp} = 200V$		1.1	2.4	μs
t_f	Fall time	$I_C = 25A$	$I_B = 2.5A$		0.08	0.25	μs
t_t	Tail Time in Turn-on	$V_{BB} = -5V$	$R_{B2} = 1\Omega$		0.02	0.15	μs
t_c	Crossover Time	$L_C = 0.32mH$	$T_J = 100^\circ C$		0.15	0.5	μs
t_s	Storage Time	$V_{CC} = 160V$	$V_{clamp} = 200V$		1.6		μs
t_f	Fall time	$I_C = 25A$	$I_B = 2.5A$		0.7		μs
t_t	Tail Time in Turn-on	$V_{BB} = 0$	$R_{B2} = 2.7\Omega$		0.2		μs
		$L_C = 0.32mH$	See fig. 3				
t_s	Storage Time	$V_{CC} = 160V$	$V_{clamp} = 200V$		2.7		μs
t_f	Fall time	$I_C = 25A$	$I_B = 2.5A$		1		μs
t_t	Tail Time in Turn-on	$V_{BB} = 0$	$R_{B2} = 2.7\Omega$		0.3		μs
		$L_C = 0.32mH$	$T_J = 100^\circ C$				

* Pulsed : Pulse duration = 300 μs , duty cycle = 2%.

Figure 1 : Switching Times Test Circuit (resistive load).

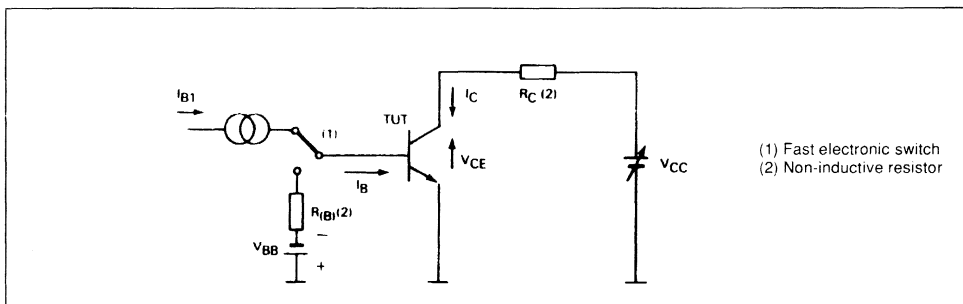

Figure 2 : Turn-on Switching Waveforms.

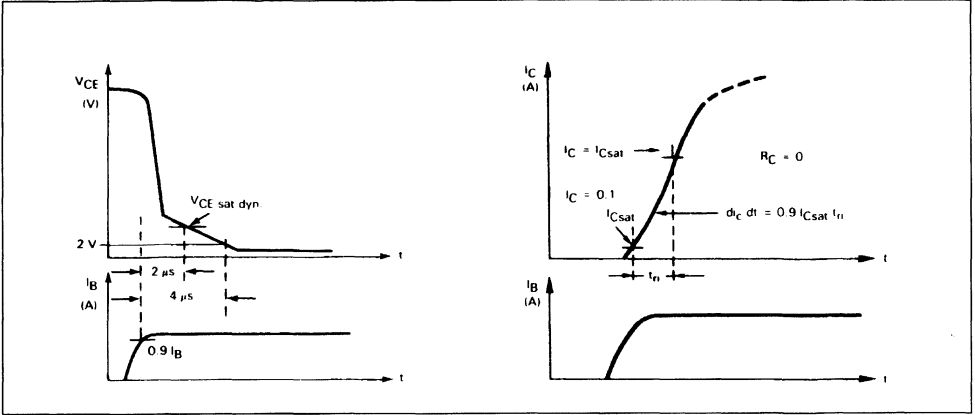

Figure 3a : Turn-off Switching Test Circuits.

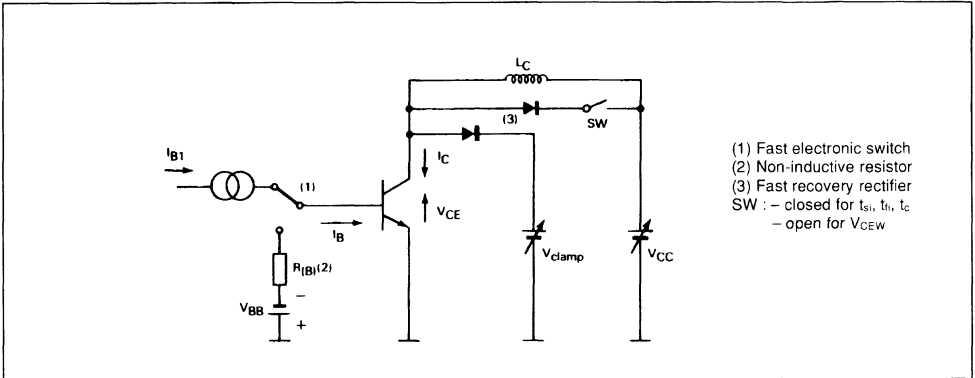
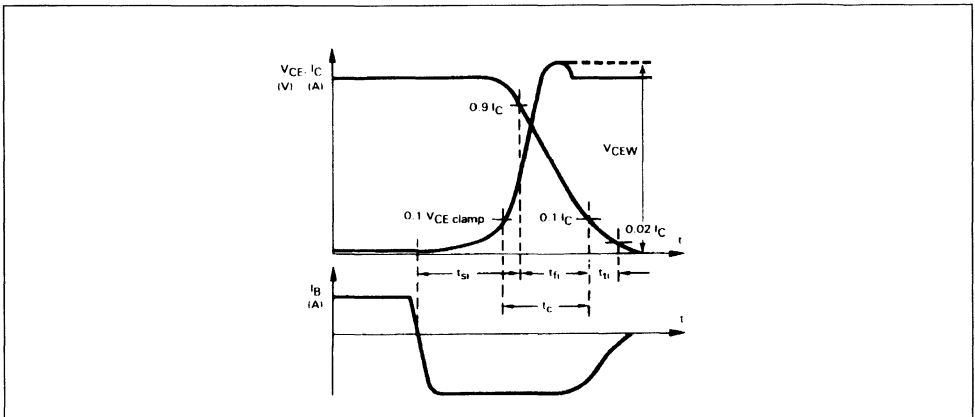
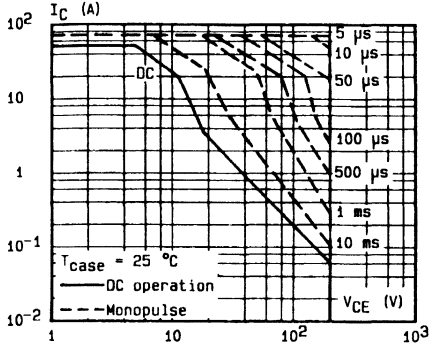

Figure 3b : Turn-off Switching Waveforms (inductive load).



DC and AC Pulse Area.



Power and $I_{S/B}$ Derating versus Case Temperature.

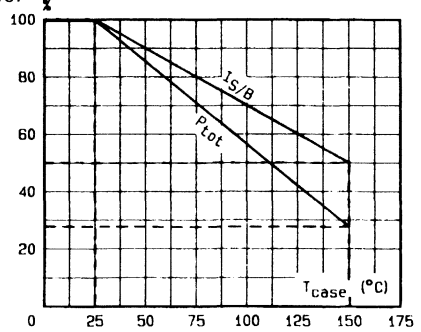

Transient Thermal Response.

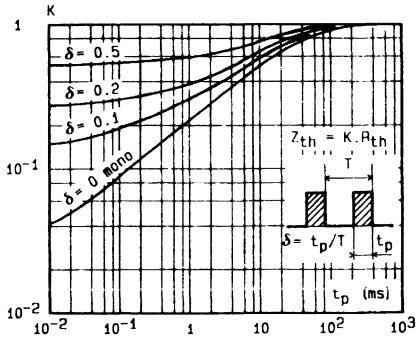

Collector-emitter Voltage versus Base-emitter Resistance.

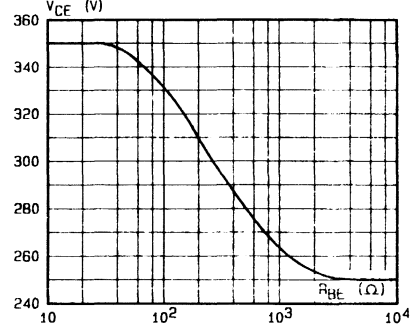

DC Current Gain.

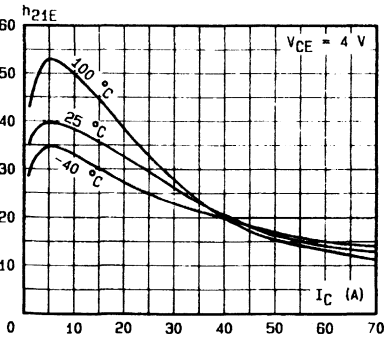

Minimum Base Current to saturate the Transistor.

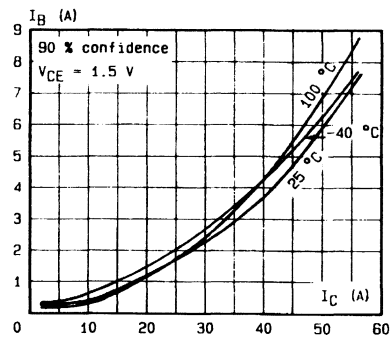

Saturation Voltage.

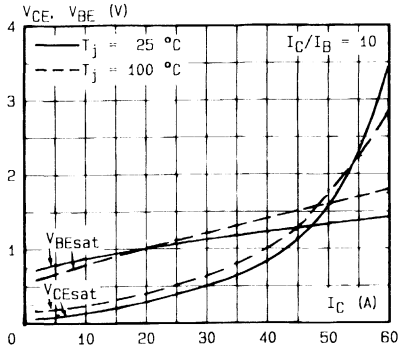

Saturation Voltage.

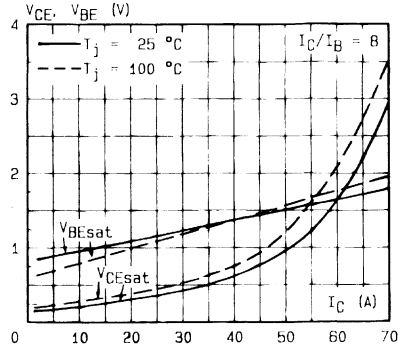

Switching Times versus Collector Current (resistive load).

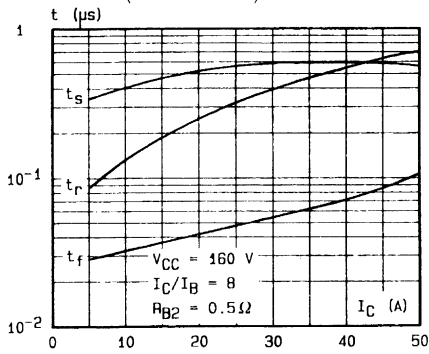

Switching Times versus Collector Current (inductive load).

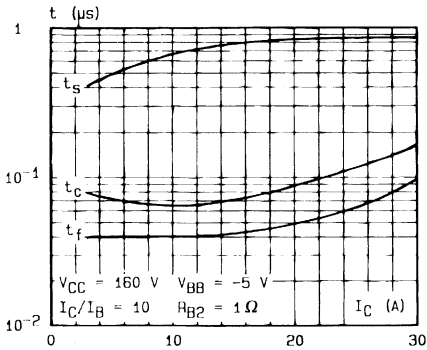

Switching Times versus Collector Current (inductive load).

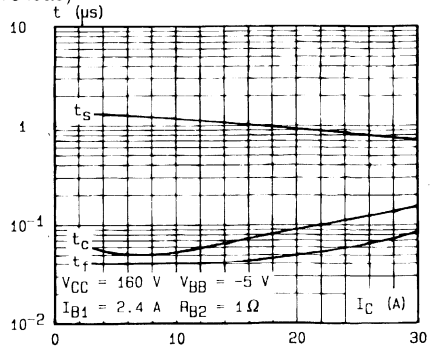

SWITCHING OPERATING AND OVERLOAD AREAS

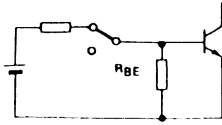

Transistor Forward Biased
 - During the turn-on
 - During the turn-off without negative base-emitter voltage and $2.7\Omega \leq R_{BE} \leq 50\Omega$

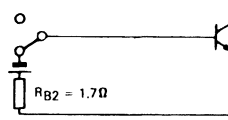

Transistor Reverse Biased
 - During the turn-off with negative base emitter voltage

Forward Biased Safe Operating Area (FBSOA).

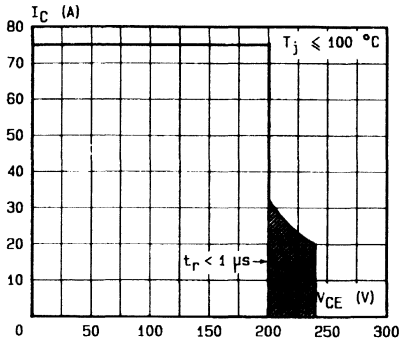

The hatched zone can only be used for turn-on.

Forward Biased Accidental Overload Area (FBAOA).

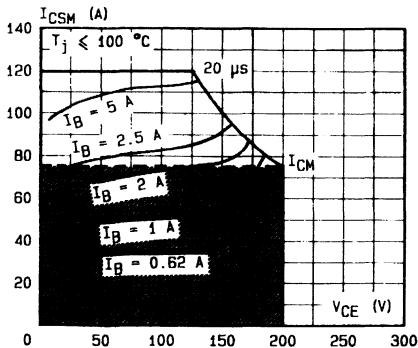

The Kellog network (heavy point) allows the calculation of the maximum value of the short-circuit for a given base current I_B (90 % confidence).

High accidental surge currents ($I > I_{CM}$) are allowed if they are non repetitive and applied less than 3000 times during the component life.

Reverse Biased Safe Operating Area (RBSOA).

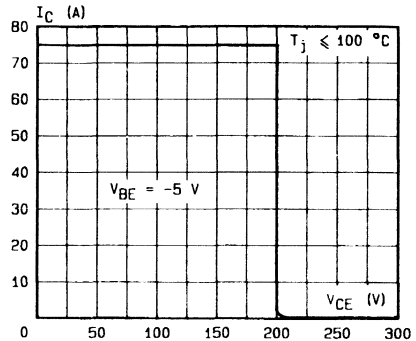

Reverse Biased Accidental Overload Area (RBAOA).

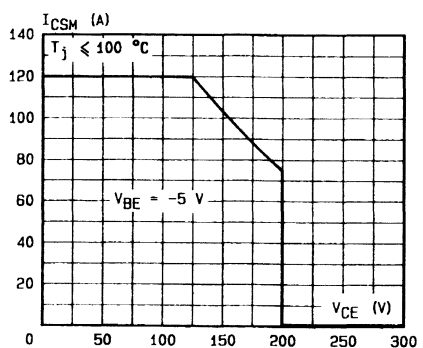

After the accidental overload current the RBAOA has to be used for the turn-off.

FAST SWITCHING POWER TRANSISTOR

- FAST SWITCHING TIMES
- LOW SWITCHING LOSSES
- VERY LOW SATURATION VOLTAGE AND HIGH GAIN FOR REDUCED LOAD OPERATION

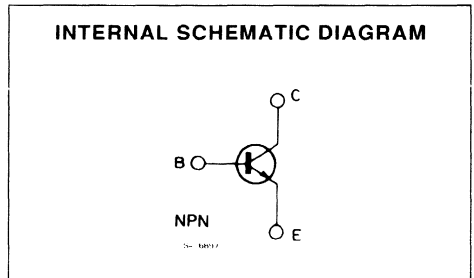
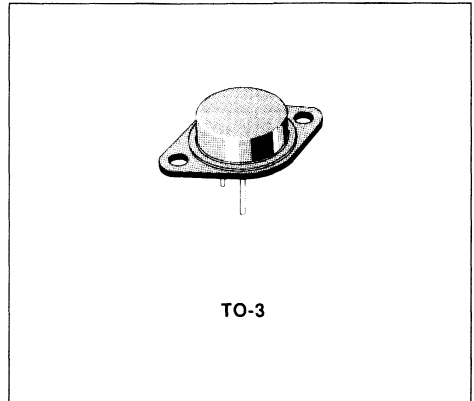

ABSOLUTE MAXIMUM RATINGS

Symbol	Parameter	Value	Unit
V_{CEV}	Collector-emitter Voltage ($V_{BE} = -1.5V$)	350	V
V_{CFO}	Collector-emitter Voltage ($I_B = 0$)	250	V
V_{EBO}	Emitter-base Voltage ($I_C = 0$)	7	V
I_C	Collector Current	40	A
I_{CM}	Collector Peak Current	60	A
I_B	Base Current	7	A
I_{BM}	Base Peak Current	12	A
P_{base}	Reverse Bias Base Dissipation (B.E. junction in avalanche)	2	W
P_{Tot}	Total Dissipation at $T_c < 25^\circ C$	250	W
T_{stg}	Storage Temperature	- 65 to 200	$^\circ C$
T_j	Max. Operating Junction Temperature	200	$^\circ C$

THERMAL DATA

$R_{th\ j-case}$	Thermal Resistance Junction-case	Max	0.7	°C/W
------------------	----------------------------------	-----	-----	------

ELECTRICAL CHARACTERISITCS ($T_{case} = 25^{\circ}C$ unless otherwise specified)

Symbol	Parameter	Test Conditions	Min.	Typ.	Max.	Unit
I_{CER}	Collector Cutoff Current ($R_{BE} = 10\Omega$)	$V_{CE} = V_{CEV}$ $V_{CE} = V_{CEV}$ $T_C = 100^{\circ}C$			1 5	mA mA
I_{CEV}	Collector Cutoff Current	$V_{CE} = V_{CEV}$ $V_{BE} = -1.5V$ $V_{CE} = V_{CEV}$ $V_{BE} = -1.5V$ $T_C = 100^{\circ}C$			1 4	mA mA
I_{LDO}	Emitter Cutoff Current ($I_C = 0$)	$V_{EB} = 5V$			1	mA
$V_{CEO(sus)}$ *	Collector Emitter Sustaining Voltage	$I_C = 0.2A$ $L = 25\ mH$	250			V
V_{EBO}	Emitter-base Voltage ($I_C = 0$)	$I_E = 50mA$	7			V
$V_{CE(sat)}$ *	Collector-emitter Saturation Voltage	$I_C = 8A$ $I_B = 0.53A$ $I_C = 16A$ $I_B = 1.6A$ $I_C = 24A$ $I_B = 3A$ $I_C = 8A$ $I_B = 0.53A$ $T_j = 100^{\circ}C$ $I_C = 16A$ $I_B = 1.6A$ $T_j = 100^{\circ}C$ $I_C = 24A$ $I_B = 3A$ $T_j = 100^{\circ}C$		0.35 0.45 0.6 0.35 0.6 0.9	0.9 0.9 1.2 1.2 1.5 1.9	V V V V V V
$V_{BE(sat)}$ *	Base-emitter Saturation Voltage	$I_C = 16A$ $I_B = 1.6A$ $I_C = 24A$ $I_B = 3A$ $I_C = 16A$ $I_B = 1.6A$ $T_j = 100^{\circ}C$ $I_C = 24A$ $I_B = 3A$ $T_j = 100^{\circ}C$		0.9 1.2 1 1.2	1.3 1.5 1.3 1.5	V V V V
di_c/dt	Rated of Rise of On-state Collector Current	$V_{CC} = 200V$ $R_C = 0$ See fig. 2	$I_{B1} = 2.4A$ $T_j = 25^{\circ}C$ $T_j = 100^{\circ}C$	50 45	130 120	A/ μs A/ μs
$V_{CE(2\mu s)}$	Collector Emitter Dynamic Voltage	$V_{CC} = 200V$ $R_C = 13\Omega$ See fig. 2	$I_{B1} = 1.6A$ $T_j = 25^{\circ}C$ $T_j = 100^{\circ}C$		1.8 2/8 6	V V V
$V_{CE(4\mu s)}$	Collector Emitter Dynamic Voltage	$V_{CC} = 200V$ $R_C = 13\Omega$ See fig. 2	$I_{B1} = 1.6A$ $T_j = 25^{\circ}C$ $T_j = 100^{\circ}C$		1.1 1.5	1.7 2.5 V V

* Pulsed : Pulse duration = 300 μs , duty cycle = 2 %.

ELECTRICAL CHARACTERISTICS (continued)

RESISTIVE LOAD

Symbol	Parameter	Test Conditions	Min.	Typ.	Max.	Unit
t_r	Rise Time	$V_{CC} = 200V$ $I_C = 24A$		0.3	0.6	μs
t_s	Storage Time	$V_{BB} = -5V$ $R_{B2} = 0.83\Omega$		1.2	1.8	μs
t_f	Fall Time	$I_B = 3A$ $t_p = 30\mu s$ See fig. 1		0.15	0.35	μs

INDUCTIVE LOAD

Symbol	Parameter	Test Conditions	Min.	Typ.	Max.	Unit
t_s	Storage Time	$V_{CC} = 200V$ $I_C = 16A$		1.2	2	μs
t_f	Fall Time	$V_{clamp} = 250V$ $I_B = 1.6A$		0.08	0.2	μs
t_t	Tail Time in Turn-on	$V_{BB} = -5V$ $R_{B2} = 1.6\Omega$ $L_C = 0.63mH$ See fig. 3		0.03	0.12	μs
t_c	Crossover Time			0.15	0.35	μs
t_s	Storage Time	$V_{CC} = 200V$ $I_C = 16A$		1.8	2.5	μs
t_f	Fall Time	$V_{clamp} = 250V$ $I_B = 1.6A$		0.2	0.4	μs
t_t	Tail Time in Turn-on	$V_{BB} = -5V$ $R_{B2} = 3.3\Omega$ $L_C = 0.63mH$ $T_j = 100^\circ C$		0.08	0.2	μs
t_c	Crossover Time	See fig. 3		0.3	0.7	μs
t_s	Storage Time	$V_{CC} = 200V$ $I_C = 16A$		3		μs
t_f	Fall Time	$V_{clamp} = 250V$ $I_B = 1.6A$		0.6		μs
t_t	Tail Time in Turn-on	$V_{BB} = 0$ $R_{B2} = 3.3\Omega$ $L_C = 0.63mH$ See fig. 3		0.2		μs
t_s	Storage Time	$V_{CC} = 200V$ $I_C = 16A$		5		μs
t_f	Fall Time	$V_{clamp} = 250V$ $I_B = 1.6A$		1		μs
t_t	Tail Time in Turn-on	$V_{BB} = 0$ $R_{B2} = 3.3\Omega$ $L_C = 0.63mH$ $T_j = 100^\circ C$ See fig. 3		0.45		μs

* Pulsed : Pulse duration = 300 μs , duty cycle = 2 %.

Figure 1 : Switching Times Test Circuit (resistive load).

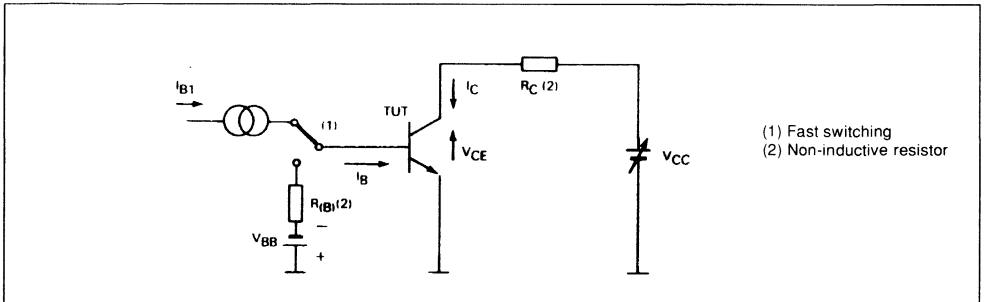

Figure 2 : Turn-on Switching Waveforms.

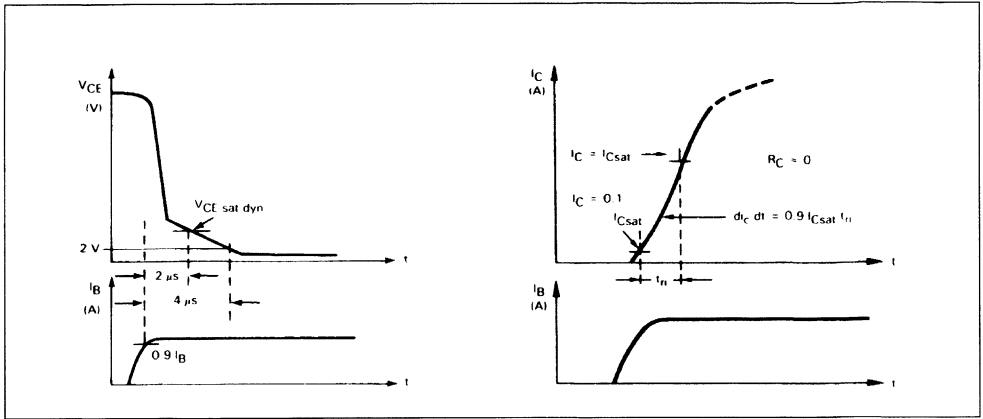

Figure 3a : Turn-on Switching Test Circuit.

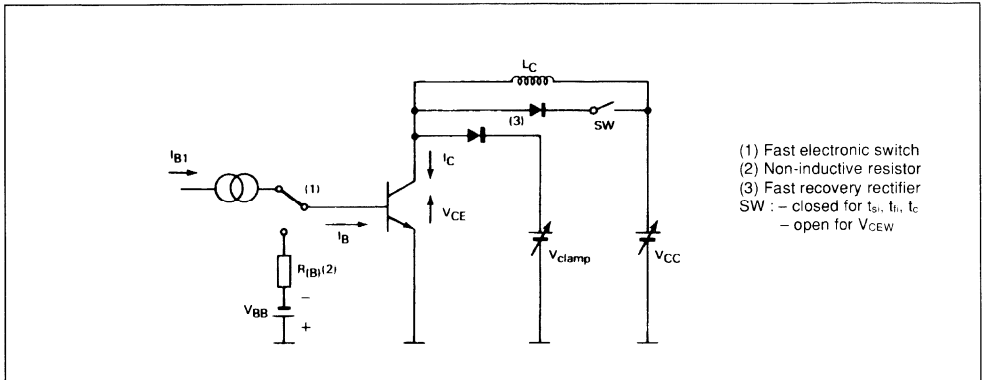
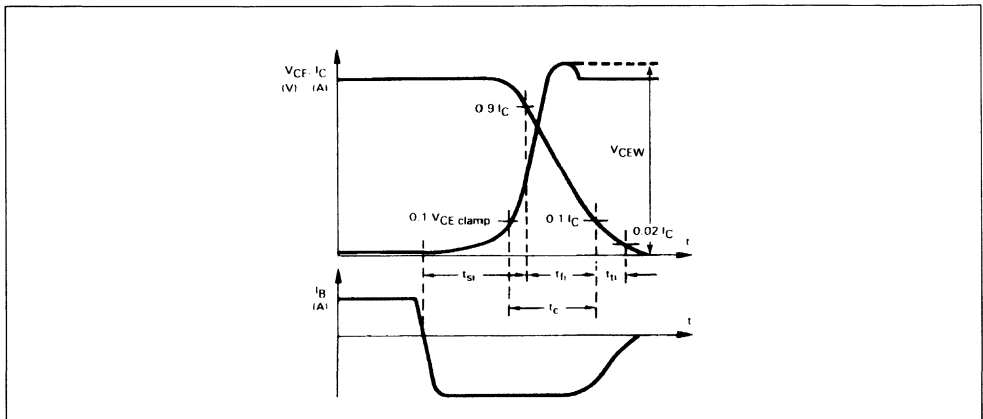
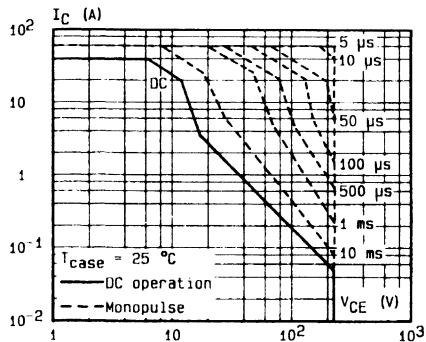

Figure 3b : Turn-off Switching Waveforms (inductive load).



DC and AC Pulse Area.



Power and $I_{S/B}$ Derating versus Case Temperature.

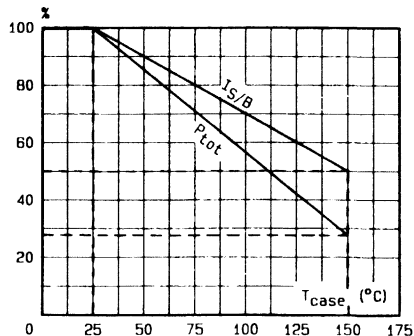

Transient Thermal Response.

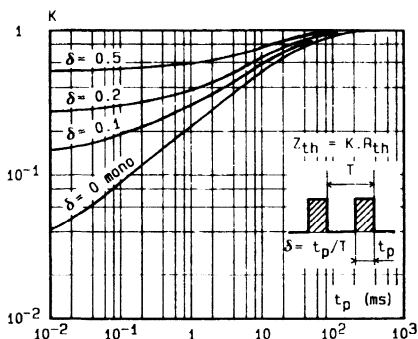

Collector-emitter Voltage versus Base-emitter Resistance.

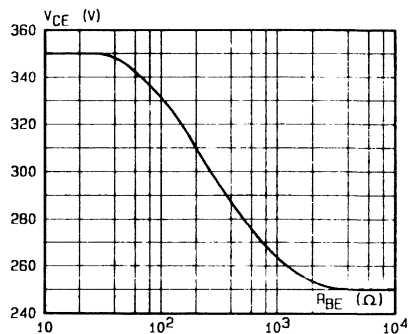

DC Current Gain.

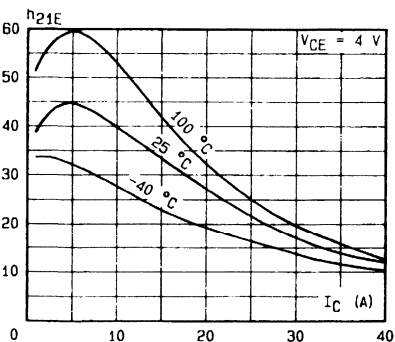

Minimum Base Current to saturate the Transistor.

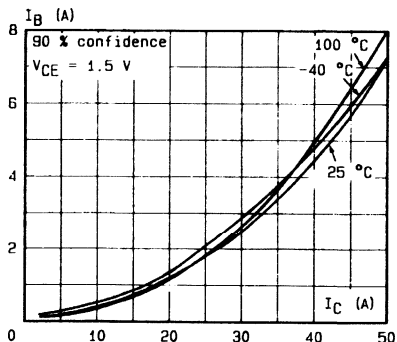

Saturation Voltage.

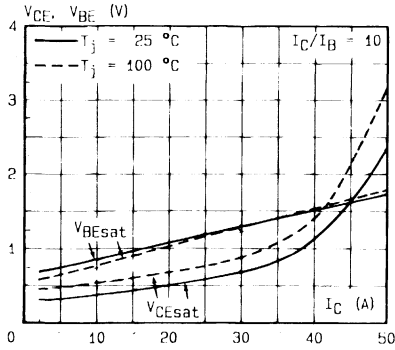

Saturation Voltage.

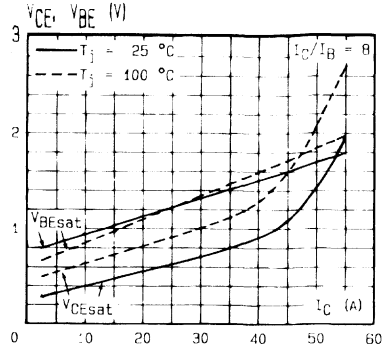

Switching Times versus Collector Current (resistive load).

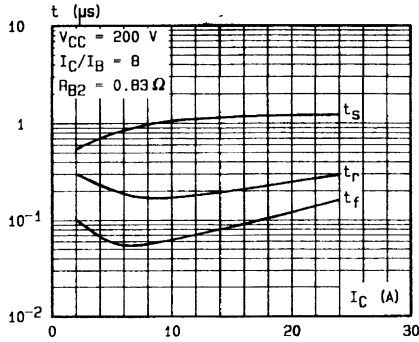

Switching Times versus Collector Current (inductive load).

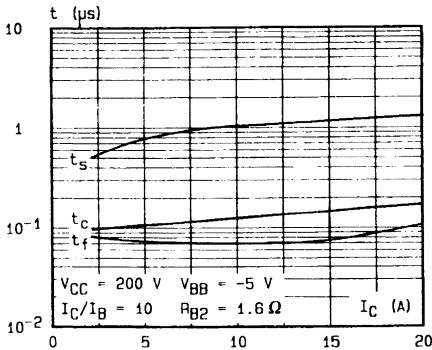

Switching Times versus Collector Current (inductive load).

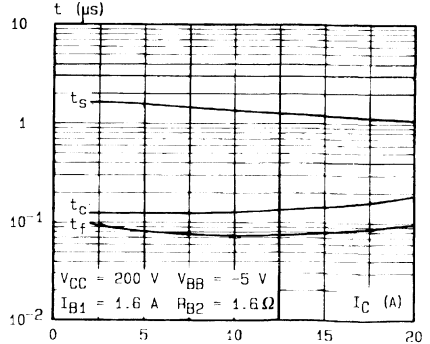

SWITCHING OPERATING AND OVERLOAD AREAS

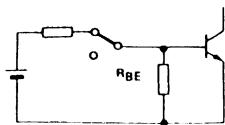

Transistor Forward Biased
 - During the turn on
 - During the turn off without negative base-emitter voltage and $3.3\Omega \leq R_{BE} \leq 50 \Omega$

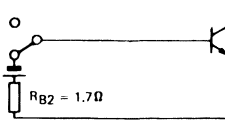

Transistor Reverse Biased
 - During the turn off with negative base emitter voltage

Forward Biased Safe Operating Area (FBSOA).

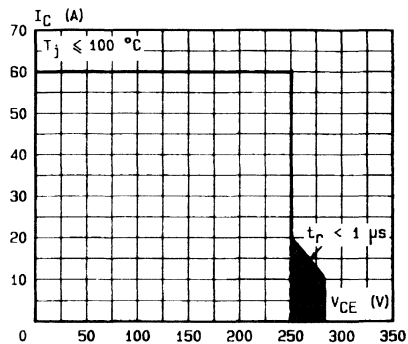

The hatched zone can only be used for turn-on

Forward Biased Accidental Overload Area (FBAOA).

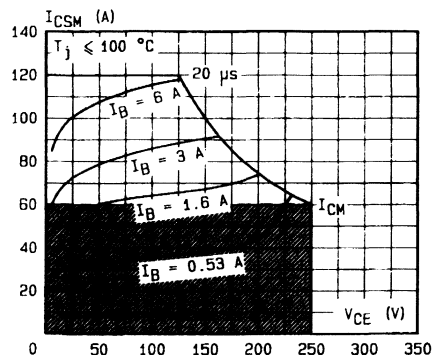

The Kellog network (heavy point) allows the calculation of the maximum value of the short-circuit for a given base current I_B (90 % confidence).

High accidental surge currents ($I > I_{CM}$) are allowed if they are non repetitive and applied less than 3000 times during the component life.

Reverse Biased Safe Operating Area (RBSOA).

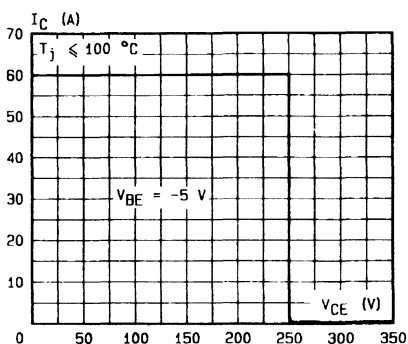

Reverse Biased Accidental Overload Area (RBAOA).

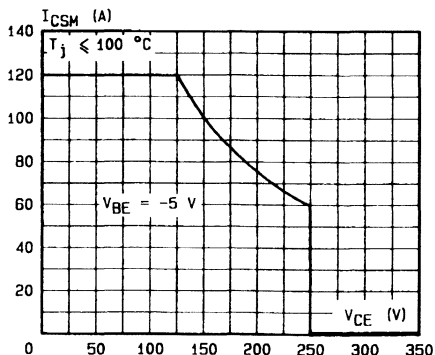

After the accidental overload current the RBAOA has to be used for the turn-off.

FAST SWITCHING POWER TRANSISTOR

- FAST SWITCHING TIMES
- LOW SWITCHING LOSSES
- LOW BASE CURRENT REQUIREMENTS
- VERY LOW SATURATION VOLTAGE AND HIGH GAIN

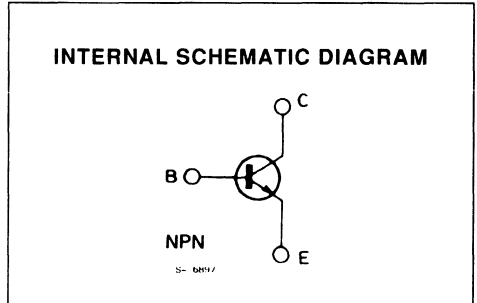
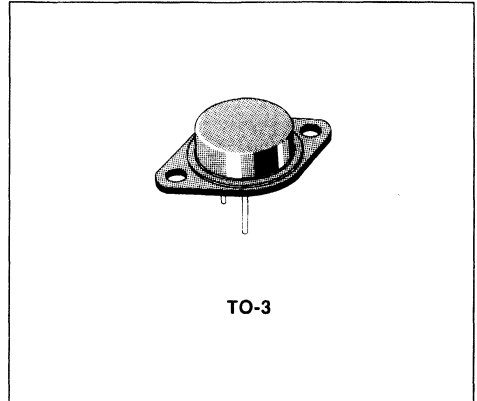

ABSOLUTE MAXIMUM RATINGS

Symbol	Parameter	Value	Unit
V_{CEV}	Collector-emitter Voltage ($V_{BE} = -1.5V$)	400	V
V_{CEO}	Collector-emitter Voltage ($I_B = 0$)	300	V
V_{EBO}	Emitter-base Voltage ($I_C = 0$)	7	V
I_C	Collector Current	40	A
I_{CM}	Collector Peak Current	60	A
I_B	Base Current	8	A
I_{BM}	Base Peak Current	12	A
P_{tot}	Total Dissipation at $T_C < 25^\circ C$	250	W
T_{stg}	Storage Temperature	- 65 to 200	$^\circ C$
T_j	Max. Operating Junction Temperature	200	$^\circ C$

THERMAL DATA

$R_{th J-case}$	Thermal Resistance Junction-case	Max	0.7	°C/W
-----------------	----------------------------------	-----	-----	------

ELECTRICAL CHARACTERISTICS ($T_{case} = 25^{\circ}C$ unless otherwise specified)

Symbol	Parameter	Test Conditions	Min.	Typ.	Max.	Unit
I_{CER}	Collector Cutoff Current ($R_{BE} = 10\Omega$)	$V_{CE} = V_{CEV}$ $V_{CE} = V_{CEV} T_c = 100^{\circ}C$			1 5	mA mA
I_{CEV}	Collector Cutoff Current	$V_{CE} = V_{CEV} V_{BE} = -1.5V$ $V_{CE} = V_{CEV} V_{BE} = -1.5V T_c = 100^{\circ}C$			1 4	mA mA
I_{EBO}	Emitter Cutoff Current ($I_C = 0$)	$V_{EB} = 5V$			1	mA
$V_{CE0(sus)^*}$	Collector Emitter Sustaining Voltage	$I_C = 0.2A$ $L = 25mH$	300			V
V_{EBO}	Emitter-base Voltage ($I_C = 0$)	$I_E = 50mA$	7			V
$V_{CE(sat)^*}$	Collector-emitter Saturation Voltage	$I_C = 15A I_B = 1.5A$ $I_C = 15A I_B = 1.5A T_j = 100^{\circ}C$			0.9 1.9	V V
$V_{BE(sat)^*}$	Base-emitter Saturation Voltage	$I_C = 15A I_B = 1.5A$ $I_C = 15A I_B = 1.5A T_j = 100^{\circ}C$			1.3 1.3	V V
di_c/dt	Rated of Rise of On-state Collector Current	$V_{CC} = 250V R_C = 0$ $t_p = 3\mu s$ See fig. 1		65		A/ μs

INDUCTIVE LOAD

Symbol	Parameter	Test Conditions	Min.	Typ.	Max.	Unit
t_s	Storage Time	$V_{CC} = 250V V_{clamp} = 300V$ $I_C = 15A I_B = 1.5A$			3	μs
t_f	Fall Time	$V_{BB} = -5V R_{BB} = 1.6\Omega$ $L_C = 0.83mH T_j = 100^{\circ}C$			0.4	μs
t_c	Crossover Time	See fig. 2			0.7	μs
V_{CEW}	Maximum Collector Emitter Voltage without Snubber	$V_{CC} = 50V I_{CWOFF} = 22A$ $V_{BB} = -5V I_{B1} = 1.5A$ $L_C = 0.11mH R_{BB} = 1.6\Omega$ $T_j = 125^{\circ}C$ See fig. 2	300			V

Figure 1 : Turn-on Switching Characteristics of the Transistor.

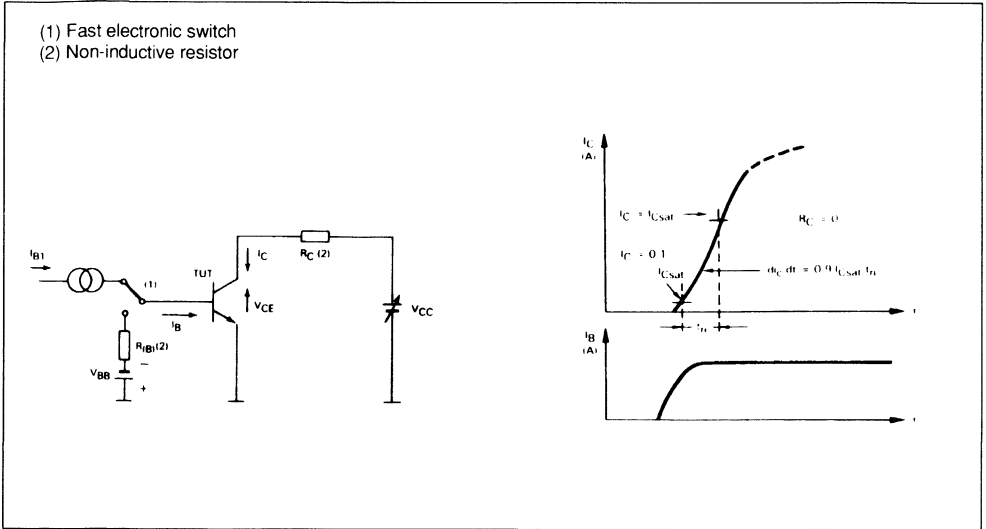
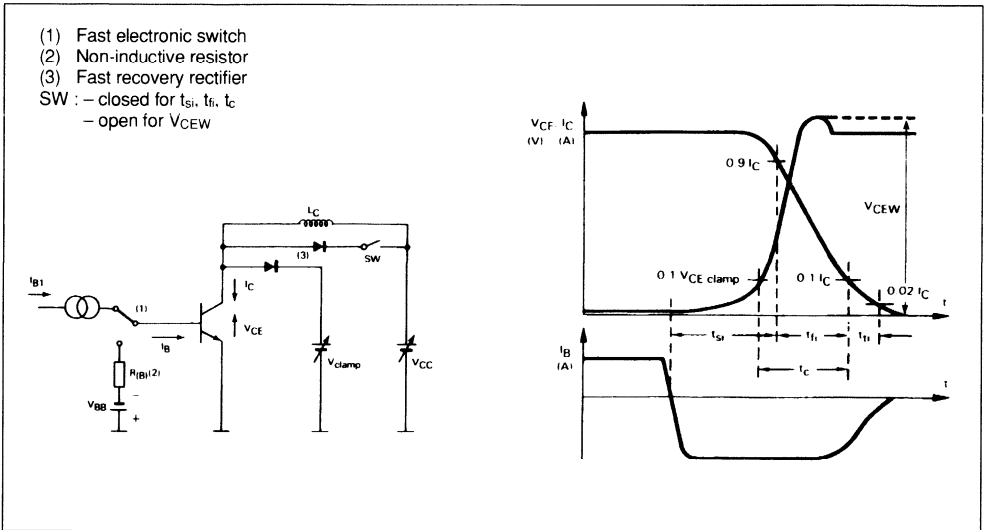
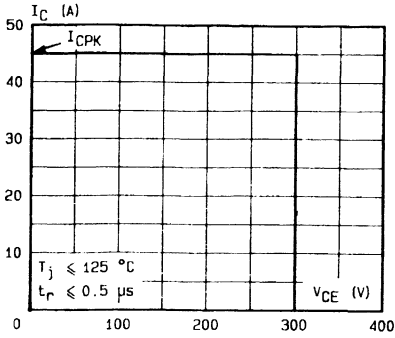

Figure 2 : Turn-off Switching Characteristics of the Transistor.



Forward Biased Safe Operating Area (FBSOA).



Reverse Biased Safe Operating Area (RBSOA).

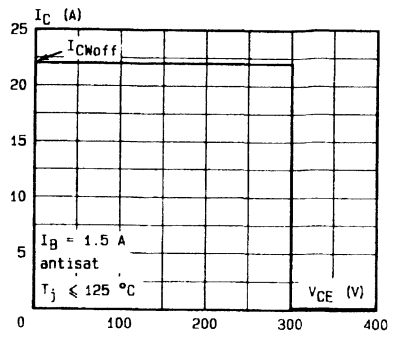

FAST SWITCHING POWER TRANSISTOR

- SUITABLE FOR SWITCHMODE POWER SUPPLY, UPS, DC AND AC MOTOR CONTROL

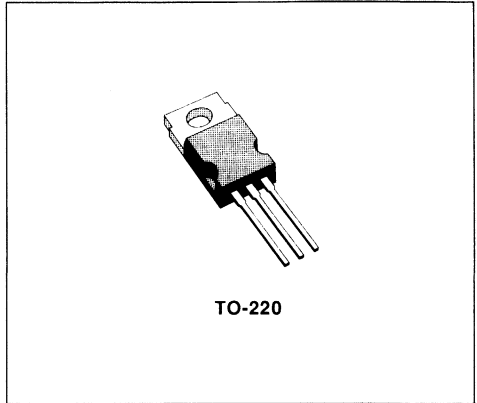
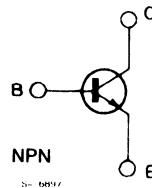
INTERNAL SCHEMATIC DIAGRAM

DESCRIPTION

High voltage, high speed transistor suited for use on the 220 and 380V mains.

ABSOLUTE MAXIMUM RATINGS

Symbol	Parameter	Value	Unit
V_{CEV}	Collector-emitter Voltage ($V_{BE} = -1.5V$)	850	V
V_{CEO}	Collector-emitter Voltage ($I_B = 0$)	450	V
V_{EBO}	Emitter-base Voltage ($I_C = 0$)	7	V
I_C	Collector Current	15	A
I_{CM}	Collector Peak Current	22	A
I_B	Base Current	5	A
I_{BM}	Base Peak Current	7.5	A
P_{tot}	Total Dissipation at $T_c < 25^\circ C$	100	W
T_{stg}	Storage Temperature	- 65 to 150	$^\circ C$
T_j	Max. Operating Junction Temperature	150	$^\circ C$

THERMAL DATA

$R_{thj-case}$	Thermal Resistance Junction-case	Max	1.25	°C/W
----------------	----------------------------------	-----	------	------

ELECTRICAL CHARACTERISTICS ($T_{case} = 25^{\circ}C$ unless otherwise specified)

Symbol	Parameter	Test Conditions	Min.	Typ.	Max.	Unit
I_{CER}	Collector Cutoff Current ($R_{BE} = 10\Omega$)	$V_{CE} = V_{CEV}$ $V_{CE} = V_{CEV}$ $T_c = 100^{\circ}C$			0.2 1.5	mA mA
I_{CEV}	Collector Cutoff Current	$V_{CE} = V_{CEV}$ $V_{BE} = -1.5V$ $V_{CE} = V_{CEV}$ $V_{BE} = -1.5V$ $T_c = 100^{\circ}C$			0.2 1.5	mA mA
I_{EBO}	Emitter Cutoff Current ($I_C = 0$)	$V_{EB} = 5V$			1	mA
$V_{CE0(sus)}^*$	Collector Emitter Sustaining Voltage	$I_C = 0.2A$ $L = 25mH$	450			V
V_{EBO}	Emitter-base Voltage ($I_C = 0$)	$I_E = 50mA$	7			V
$V_{CE(sat)}^*$	Collector-emitter Saturation Voltage	$I_C = 8A$ $I_B = 1.6A$ $I_C = 8A$ $I_B = 1.6A$ $T_j = 100^{\circ}C$			1.2 2	V V
$V_{BE(sat)}^*$	Base-emitter Saturation Voltage	$I_C = 8A$ $I_B = 1.6A$ $I_C = 8A$ $I_B = 1.6A$ $T_j = 100^{\circ}C$			1.3 1.3	V V
di_c/dt	Rate of Rise of On-state Collector Current	$V_{CC} = 300V$ $R_C = 0$ $I_{B1} = 2.4A$ $t_p = 3\mu s$ $T_j = 100^{\circ}C$ See fig. 1	45			A/ μs

INDUCTIVE LOAD

Symbol	Parameter	Test Conditions	Min.	Typ.	Max.	Unit
t_s	Storage Time	$V_{CC} = 400V$ $V_{clamp} = 450V$ $I_C = 8A$ $I_B = 1.6A$			3	μs
t_f	Fall Time	$V_{BB} = -5V$ $R_{BB} = 1.6\Omega$ $L_C = 2.5mH$ $T_j = 100^{\circ}C$			0.4	μs
t_c	Crossover Time	see fig. 2			0.7	μs
V_{CEW}	Maximum Collector Emitter Voltage without Snubber	$V_{CC} = 50V$ $I_{Cwoff} = 12A$ $V_{BB} = -5V$ $I_{B1} = 1.6A$ $L_C = 0.21mH$ $R_{BB} = 1.6\Omega$ $T_j = 125^{\circ}C$ See fig. 2	450			V

Figure 1 : Turn-on Switching Characteristics of the Transistor.

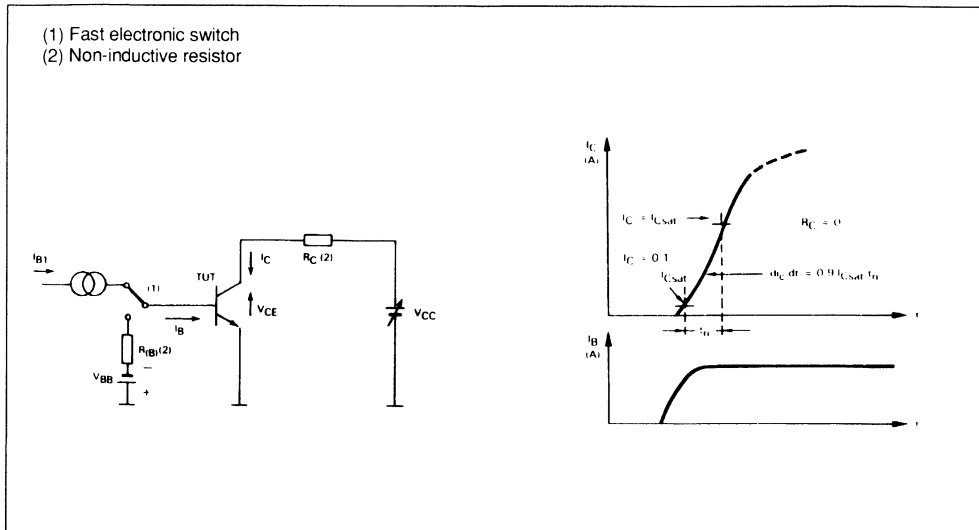
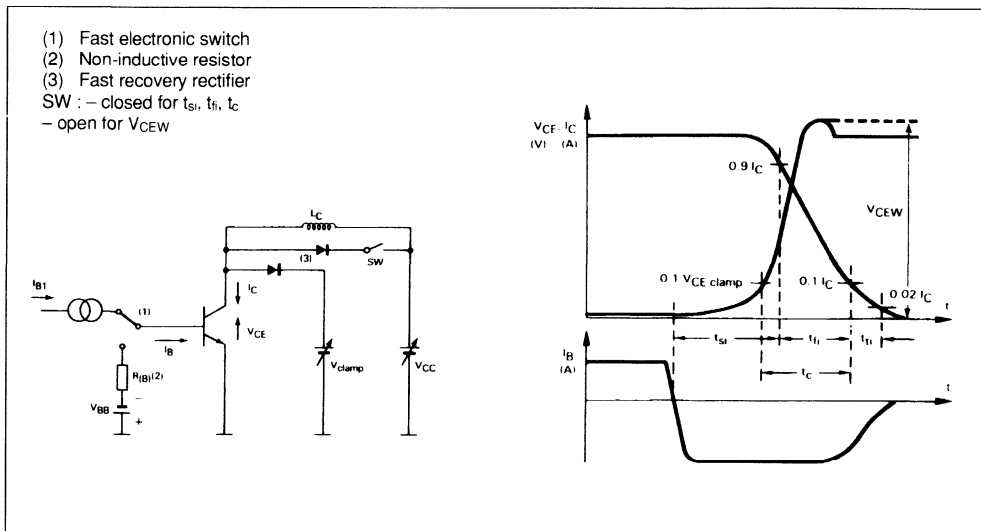
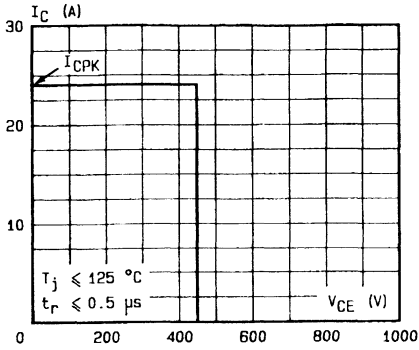

Figure 2 : Turn-off Switching Characteristics of the Transistor.



Forward Biased Safe Operating Area (FBSOA).



Reverse Biased Safe Operating Area (RBSOA).

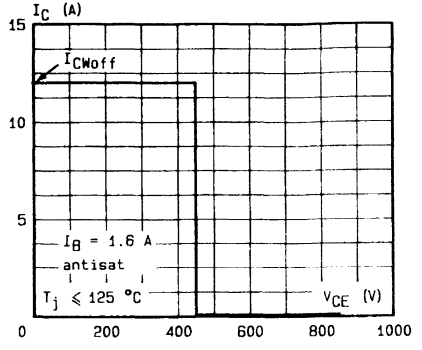

HIGH VOLTAGE POWER SWITCH

DESCRIPTION

The BUW12 and BUW12A are silicon multiepitaxial mesa NPN transistors in SOT-93 plastic package, particularly intended for high voltage, fast switching industrial applications.

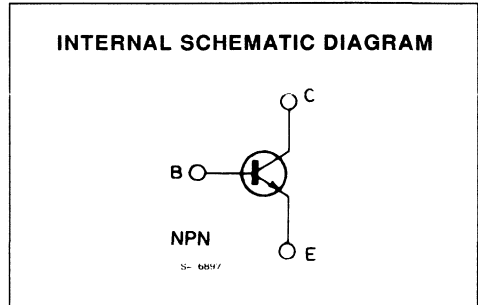
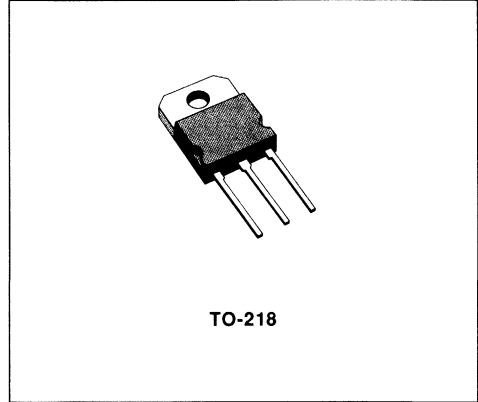

ABSOLUTE MAXIMUM RATINGS

Symbol	Parameter	Value		Unit
		BUW12	BUW12A	
V_{CES}	Collector-emitter Voltage ($V_{BE} = 0$)	850	1000	V
V_{CEO}	Collector-emitter Voltage ($I_B = 0$)	400	450	V
I_C	Collector Current	8		A
I_{CM}	Collector Peak Current ($t_p \leq 2$ ms)	20		A
I_B	Base Current	4		A
I_{BM}	Base Peak Current ($t_p \leq 2$ ms)	6		A
P_{tot}	Total Power Dissipation at $T_{case} \leq 25$ °C	100		W
T_{stg}	Storage Temperature	- 65 to 150		°C
T_j	Junction Temperature	150		°C

THERMAL DATA

$R_{th\ j-case}$	Thermal Resistance Junction-case	max	1.25	$^{\circ}C/W$
------------------	----------------------------------	-----	------	---------------

ELECTRICAL CHARACTERISTICS ($T_{case} = 25\ ^{\circ}C$ unless otherwise specified)

Symbol	Parameter	Test Conditions	Min.	Typ.	Max.	Unit
I_{CES}	Collector Cutoff Current ($V_{BE} = 0$)	$V_{CE} = V_{CES}$ $V_{CE} = V_{CES}$ $T_j = 125\ ^{\circ}C$			1 3	mA mA
I_{EBO}	Emitter Cutoff Current ($I_C = 0$)	$V_{EB} = 9\ V$			10	mA
$V_{CE(sus)}^*$	Collector-emitter Sustaining Voltage	$I_C = 100\ mA$ $L = 25\ mH$	400			V
$V_{CE(sat)}^*$	Collector-emitter Saturation Voltage	$I_C = 6\ A$ $I_B = 1.2\ A$			1.5	V
$V_{BE(sat)}^*$	Base-emitter Saturation Voltage	$I_C = 6\ A$ $I_B = 1.2\ A$			1.5	V
t_{on}	Turn-on Time	$I_C = 6\ A$ $I_{B1} = 1.2\ A$			1	ns
t_s	Storage Time	$I_{B2} = 1.2\ A$			4	μs
t_f	Fall Time				0.8	μs

* Pulsed : pulse duration = 300 μs , duty cycle = 1.5 %.

Safe Operating Areas.

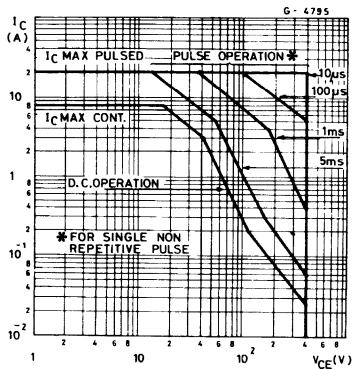

HIGH VOLTAGE POWER SWITCH

DESCRIPTION

The BUW22, BUW22A are silicon multiepitaxial mesa PNP transistor in Jedec TO-3 metal case, particularly intended for switching applications.

The BUW22P, BUW22AP are mounted in TO-220 plastic package.

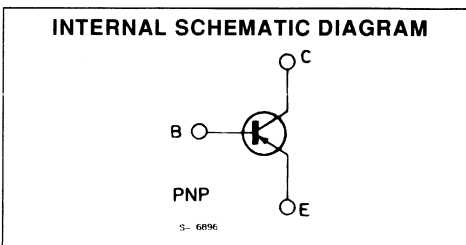
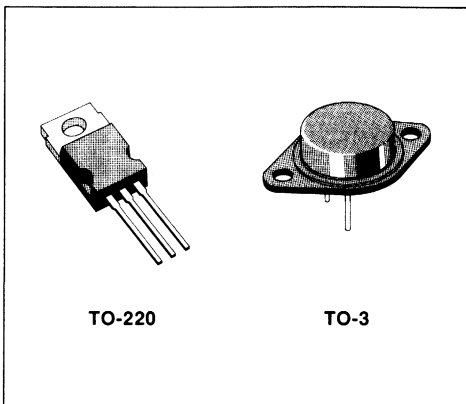

ABSOLUTE MAXIMUM RATINGS

Symbol	Parameter	Value		Unit
		BUW22/P	BUW22A/AP	
V_{CES}	Collector-emitter Voltage ($V_{BE} = 0$)	- 400	- 450	V
V_{CEO}	Collector-emitter Voltage ($I_B = 0$)	- 350	- 400	V
V_{EBO}	Emitter-base Voltage ($I_C = 0$)	- 5	- 7	V
I_C	Collector Current	- 6		A
I_{CM}	Collector Peak Current ($t_p \leq 10$ ms)	- 8		A
I_B	Base Current	- 2		A
I_{BM}	Base Peak Current ($t_p \leq 10$ ms)	- 4		A
		TO-3	TO-220	
P_{Tot}	Total Power Dissipation at $T_{case} \leq 25$ °C	75	60	W
T_{stg}	Storage Temperature	- 65 to 175	- 65 to 150	°C
T_j	Junction Temperature	175	150	°C

THERMAL DATA

$R_{th(j-case)}$	Thermal Resistance Junction-case	max	2	$^{\circ}C/W$
------------------	----------------------------------	-----	---	---------------

ELECTRICAL CHARACTERISTICS ($T_{case} = 25^{\circ}C$ unless otherwise specified)

Symbol	Parameter	Test Conditions	Min.	Typ.	Max.	Unit
I_{CES}	Collector Cutoff Current ($V_{BE} = 0$)	$V_{CE} = \text{Rated } V_{CES}$ $T_{case} = 125^{\circ}C$ $V_{CE} = \text{Rated } V_{CES}$			- 1	mA
I_{EBO}	Collector Cutoff Current ($I_C = 0$)	$V_{EB} = \text{Rated } V_{EBO}$			- 5	mA
$V_{CE(sus)}$ *	Collector-emitter Sustaining Voltage ($I_B = 0$)	$I_C = - 100 \text{ mA}$ for BUW22/P for BUW22A/AP	- 350 - 400			V V
$V_{CE(sat)}$ *	Base-emitter Saturation Voltage	$I_C = - 2.5 \text{ A}$ $I_B = - 1 \text{ A}$			- 1.5	V
$V_{BE(sat)}$ *	Base-emitter Saturation Voltage	$I_C = - 2.5 \text{ A}$ $I_B = - 1 \text{ A}$			- 1.6	V
h_{FE} *	DC Current Gain	$I_C = - 0.5 \text{ A}$ $V_{CE} = - 5 \text{ V}$	12			
$I_{S/b}$	Second Breakdown Collector Current	$V_{CE} = - 30 \text{ V}$ for BUW22/A for BUW22P/AP	- 2.5 - 2			A A
t_{on}	Turn-on Time	Resistive Load $V_{CC} = - 250 \text{ V}$ $I_C = - 2.5 \text{ A}$ $I_{B1} = - I_{B2} = - 0.5 \text{ A}$		0.4	0.8	μs
t_s	Storage Time			0.6	1.5	μs
t_f	Fall Time			0.3	0.7	μs

* Pulsed : pulse duration = 300 μs , duty cycle = 1.5 %.

Safe Operating Areas.
(BUW22AP - BUW22P).

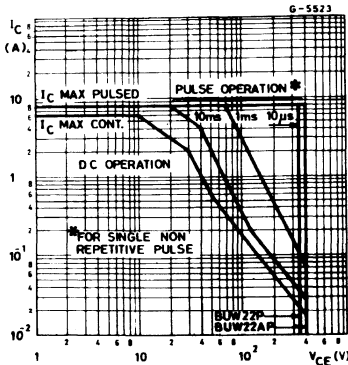

Safe Operating Areas.
(BUW22 - BUW22A).

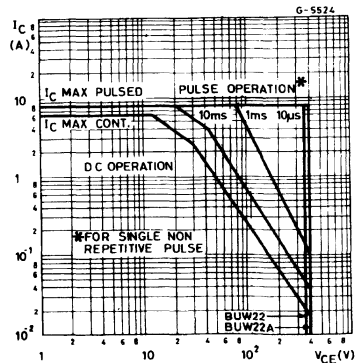

Transient Thermal Response.

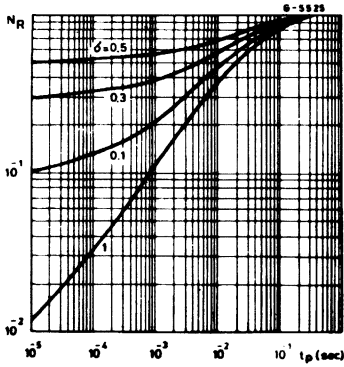

DC Current Gain.

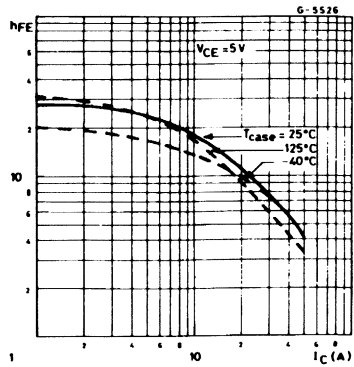

Collector-emitter Saturation Voltage.

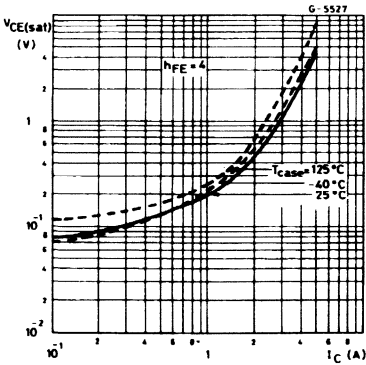

Collector-emitter Saturation Voltage.

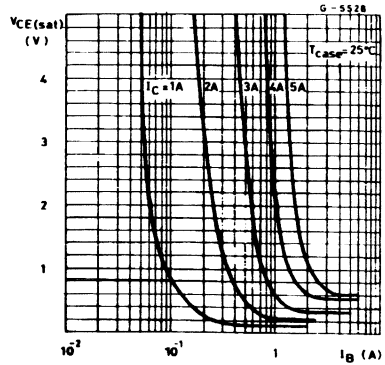

Base-emitter Saturation Voltage.

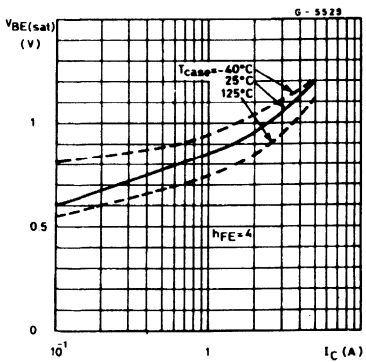

Base-emitter On Voltage.

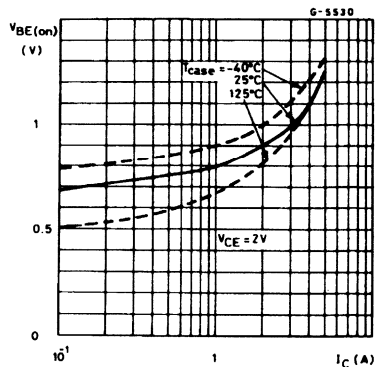

Switching Times Resistive Load (test circuit fig. 1).

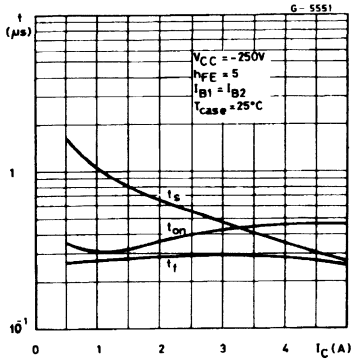

Switching Time Percentage Variation vs. T_{case}.

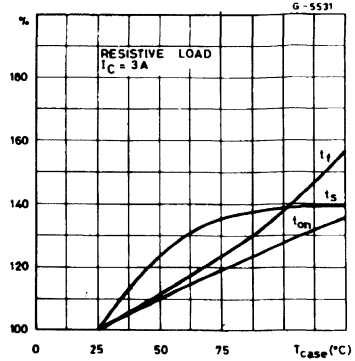

Turn-off Switching Times Inductive Load (test circuit fig. 2).

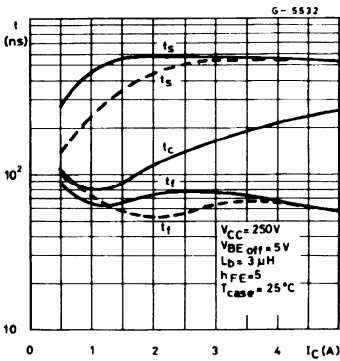

Switching Times Percentage Variation vs. T_{case}.

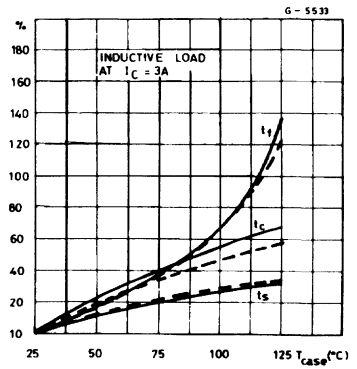

Capacitance.

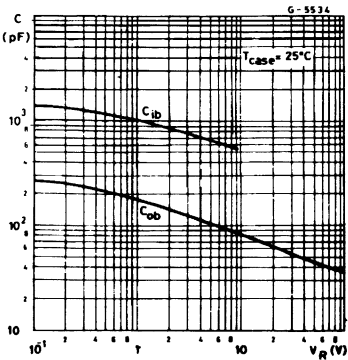

Reserve Biased Safe Operating Area.

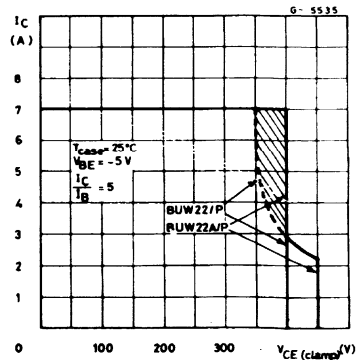

TEST CIRCUITS.

Figure 1.

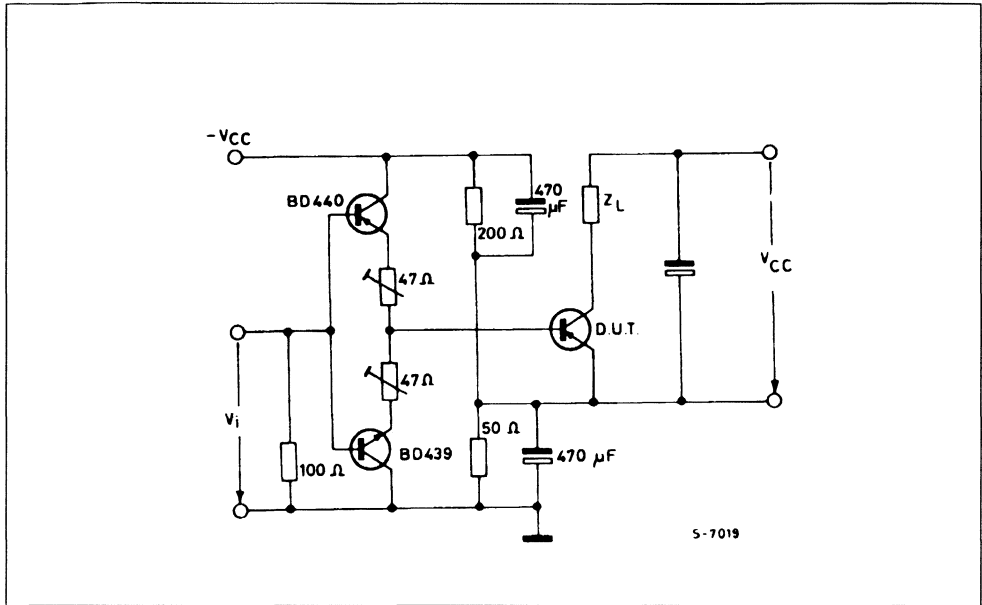
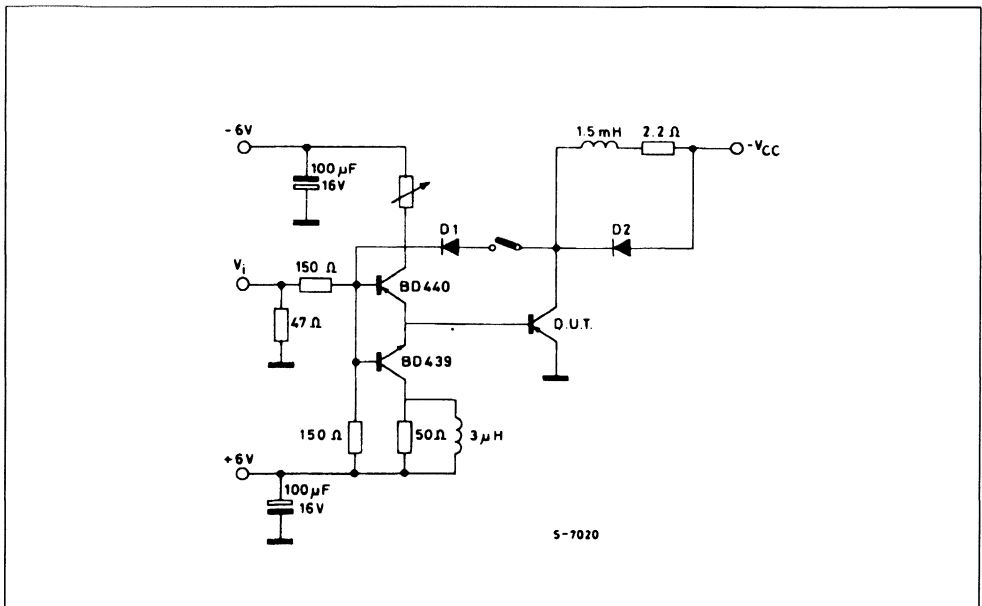

Figure 2.



HIGH VOLTAGE POWER SWITCH

DESCRIPTION

The BUW32/A, BUW32P/AP and BUW32PFI/APFI are silicon multiepitaxial mesa PNP transistors mounted respectively in TO-3 metal case, TO-218 plastic package and ISOWATT218 fully isolated package. They are intended for high voltage, fast switching and industrial applications.

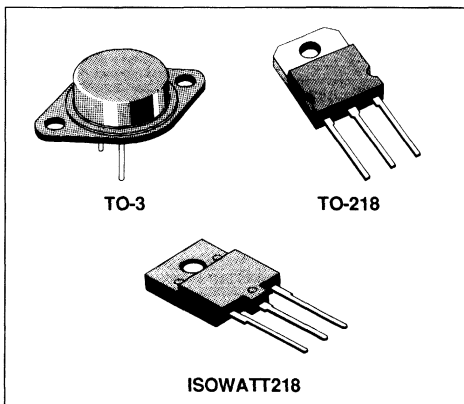

INTERNAL SCHEMATIC DIAGRAM

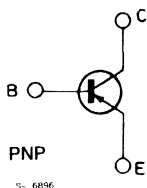

ABSOLUTE MAXIMUM RATINGS

Symbol	Parameter	BUW			Unit
		32/P/PFI	32A/AP/APFI		
V_{CES}	Collector-emitter Voltage ($V_{BE} = 0$)	- 400	- 450		V
V_{CEO}	Collector-emitter Voltage ($I_B = 0$)	- 350	- 400		V
V_{EBO}	Emitter-base Voltage ($I_C = 0$)	- 5	- 7		V
I_C	Collector Current	- 10			A
I_B	Base Current	- 5			A
		TO-3	TO-218	ISOWATT218	
P_{tot}	Total Power Dissipation at $T_c < 25\text{ }^\circ\text{C}$	125	105	55	W
T_{stg}	Storage Temperature	- 65 to 175	- 65 to 150	- 65 to 150	$^\circ\text{C}$
T_j	Max. Operating Junction Temperature	175	150	150	$^\circ\text{C}$

THERMAL DATA

			TO-3	TO-218	ISOWATT218	
$R_{th\ j-case}$	Thermal Resistance Junction-case	max	1.19	1.19	2.27	°C/W

ELECTRICAL CHARACTERISTICS ($T_{case} = 25\text{ °C}$ unless otherwise specified)

Symbol	Parameter	Test Conditions	Min.	Typ.	Max.	Unit
I_{CES}	Collector Cutoff Current ($V_{BE} = 0$)	$V_{CE} = \text{Rated } V_{CEs}$			- 1	mA
		$V_{CE} = \text{Rated } V_{CEs}$ $T_{case} = 125\text{ °C}$			- 5	mA
I_{EBO}	Emitter Cutoff Current ($I_C = 0$)	$V_{EB} = \text{Rated } V_{EBO}$			- 1	mA
$V_{CEO(sus)}^*$	Collector-emitter Sustaining Voltage ($I_B = 0$)	$I_C = - 100\text{ mA}$ for BUW32/P/PFI for BUW32A/AP/APFI	- 350 - 400			V V
$V_{CE(sat)}^*$	Collector-emitter Saturation Voltage	$I_C = - 5\text{ A}$ $I_B = - 1.5\text{ A}$			- 1.5	V
$V_{BE(sat)}^*$	Base-emitter Saturation Voltage	$I_C = - 5\text{ A}$ $I_B = - 1.5\text{ A}$			- 1.6	V
h_{FE}^*	DC Current Gain	$I_C = - 1\text{ A}$ $V_{CE} = - 5\text{ V}$	12			
$I_{s/b}$	Second Breakdown Collector Current	$V_{CE} = - 30\text{ V}$ for BUW32/A	- 4.2			A
		for BUW32P/AP	- 3.5			A
		for BUW32PFI/APFI	- 1.7			A
t_{on}	Turn-on Time	Resistive Load		0.3	0.6	μs
t_s	Storage Time	$V_{CC} = - 250\text{ V}$		0.7	1.5	μs
t_f	Fall Time	$I_C = - 5\text{ A}$ $I_{B1} = - I_{B2} = - 1\text{ A}$		0.25	0.6	μs

* Pulsed : pulse duration = 300 μs, duty cycle = 1.5 %.

Safe Operating Areas.

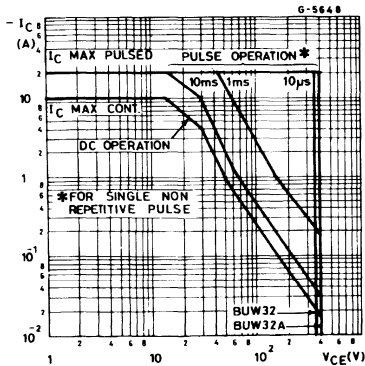

Safe Operating Areas.

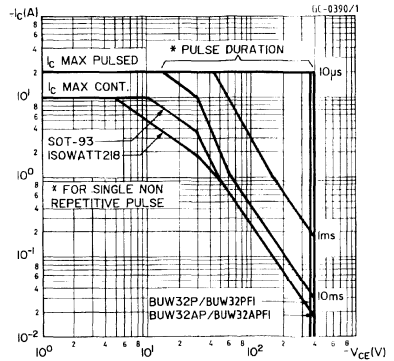

DC Current Gain.

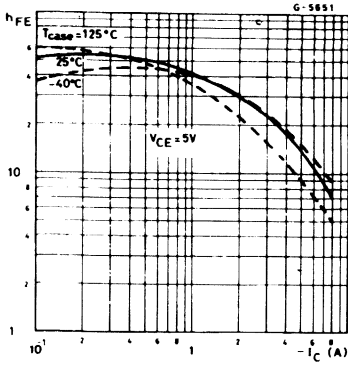

Collector-emitter Saturation Voltage.

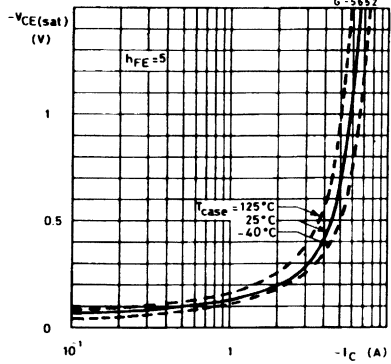

Collector-emitter Saturation Voltage.

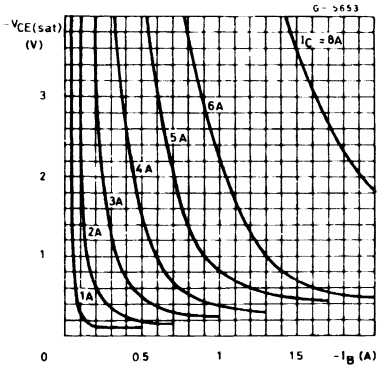

Base-emitter Saturation Voltage.

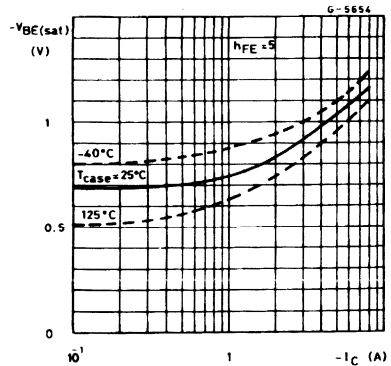

Clamped Reverse Bias Safe Operating Areas.

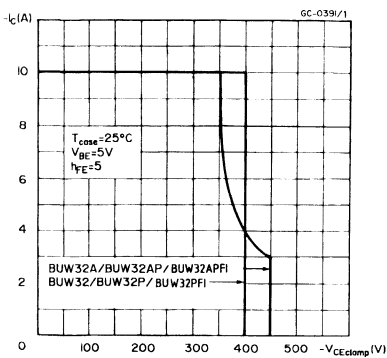

Saturated Switching Characteristics (test circuit fig. 1).

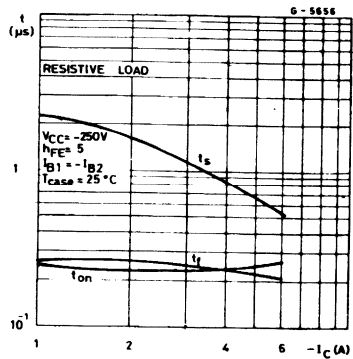

Switching Times Percentage Variation vs. T_{case} Resistive Load.

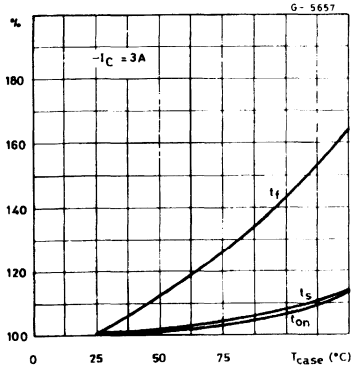

Switching Times Resistive Load (test circuit fig. 2).

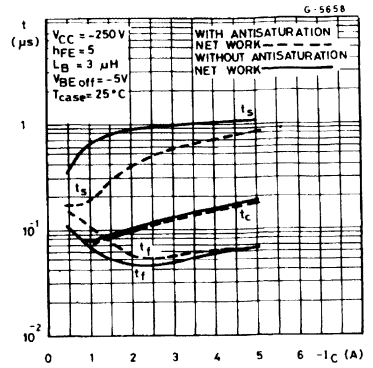

Switching Time Percentage Variation vs. T_{case} Resistive Load.

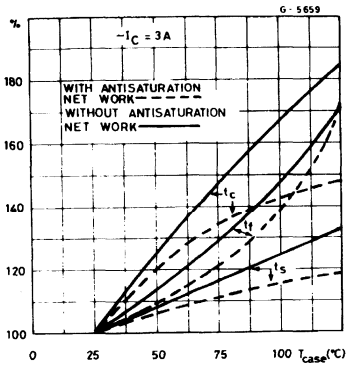

Capacitance.

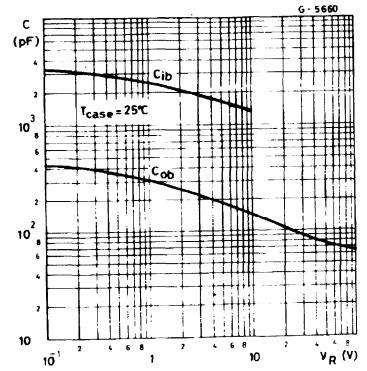

TEST CIRCUITS.

Figure 1.

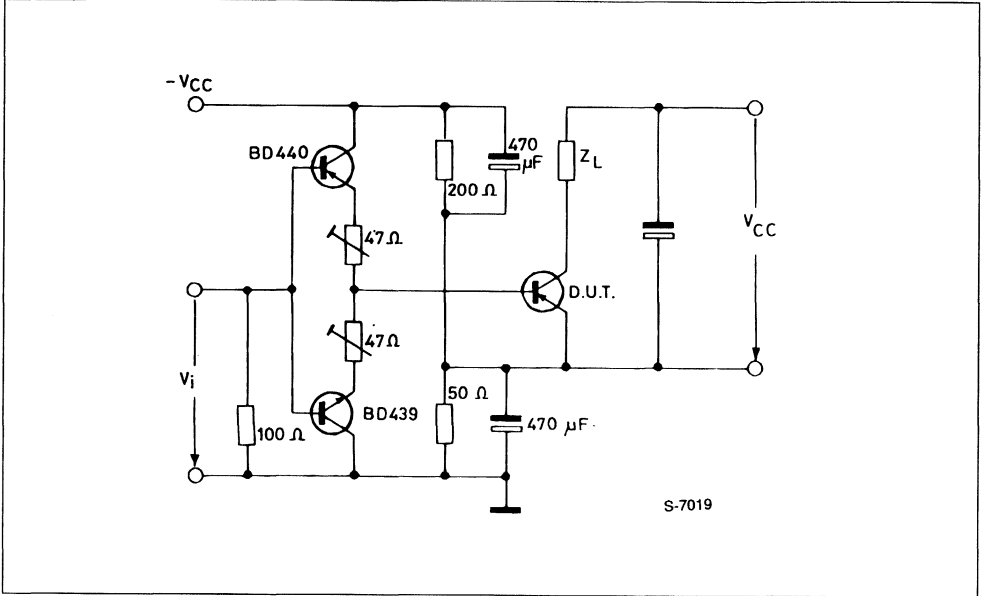
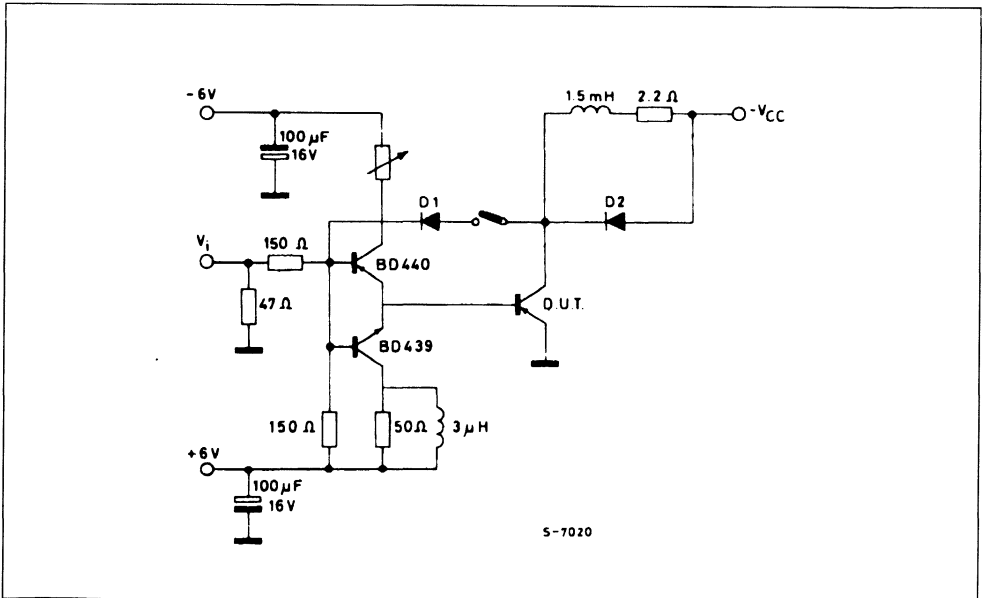

Figure 2.



ISOWATT218 PACKAGE CHARACTERISTICS AND APPLICATION.

ISOWATT218 is fully isolated to 4000V dc. Its thermal impedance, given in the data sheet, is optimized to give efficient thermal conduction together with excellent electrical isolation. The structure of the case ensures optimum distances between the pins and heatsink. These distances are in agreement with VDE and UL creepage and clearance standards. ISOWATT218 package eliminates the need for external isolation so reducing fixing hardware.

The package is supplied with leads longer than the standard TO-218 to allow easy mounting on pcbs.

Accurate moulding techniques used in manufacture assures consistent heat spreader-to-heatsink capacitance.

ISOWATT218 thermal performance is equivalent to that of the standard part, mounted with a 0.1 mm mica washer. The thermally conductive plastic has a higher breakdown rating and is less fragile than mica or plastic sheets. Power derating for ISOWATT218 packages is determined by :

$$P_D = \frac{T_j - T_c}{R_{th}}$$

THERMAL IMPEDANCE OF ISOWATT218 PACKAGE

Fig. 3 illustrates the elements contributing to the thermal resistance of a transistor heatsink assembly, using ISOWATT218 package.

The total thermal resistance $R_{th(tot)}$ is the sum of each of these elements. The transient thermal impedance, Z_{th} for different pulse durations can be estimated as follows :

1 - For a short duration power pulse of less than 1ms :

$$Z_{th} < R_{thJ-C}$$

2 - For an intermediate power pulse of 5ms to 50ms seconds :

$$Z_{th} = R_{thJ-C}$$

3 - For long power pulses of the order of 500ms seconds or greater :

$$Z_{th} = R_{thJ-C} + R_{thC-HS} + R_{thHS-amb}$$

It is often possible to discern these areas on transient thermal impedance curves.

Figure 3.

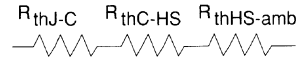

HIGH VOLTAGE POWER SWITCH

DESCRIPTION

The BUW34, BUW35 and BUW36 are silicon multi-epitaxial mesa NPN transistors in Jedec TO-3 metal case. They are intended for high voltage, fast switching applications.

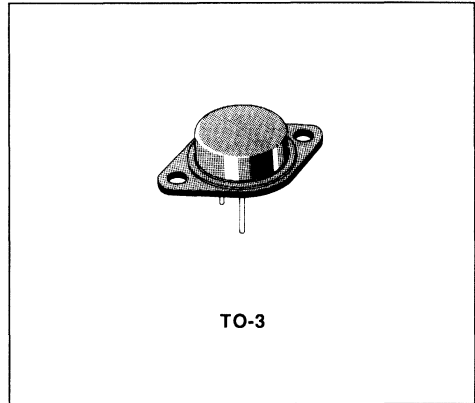

INTERNAL SCHEMATIC DIAGRAM

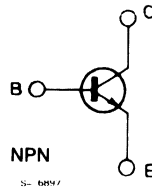

ABSOLUTE MAXIMUM RATINGS

Symbol	Parameter	Value			Unit
		BUW34	BUW35	BUW36	
V_{CES}	Collector-emitter Voltage ($V_{BE} = 0$)	500	800	900	V
V_{CEO}	Collector-emitter Voltage ($I_B = 0$)	400	400	450	V
V_{EBO}	Emitter-base Voltage ($I_C = 0$)	7			V
I_C	Collector Current	10			A
I_{CM}	Collector Peak Current	15			A
I_B	Base Current	5			A
P_{tot}	Total Power Dissipation at $T_{case} \leq 25^\circ\text{C}$	125			W
T_{stg}	Storage Temperature	- 65 to 200			$^\circ\text{C}$
T_j	Junction Temperature	200			$^\circ\text{C}$

THERMAL DATA

$R_{th\ j-case}$	Thermal Resistance Junction-case	max	1.4	$^{\circ}C/W$
------------------	----------------------------------	-----	-----	---------------

ELECTRICAL CHARACTERISTICS ($T_{case} = 25\ ^{\circ}C$ unless otherwise specified)

Symbol	Parameter	Test Conditions	Min.	Typ.	Max.	Unit
I_{CES}	Collector Cutoff Current ($V_{BE} = 0$)	for BUW34 $V_{CE} = 500\ V$			500	μA
		for BUW35 $V_{CE} = 800\ V$			500	μA
		for BUW36 $V_{CE} = 900\ V$			500	μA
		$T_{case} = 125\ ^{\circ}C$				
		for BUW34 $V_{CE} = 500\ V$			3	mA
		for BUW35 $V_{CE} = 800\ V$			3	mA
		for BUW36 $V_{CE} = 900\ V$			3	mA
I_{EBO}	Emitter Cutoff Current ($I_C = 0$)	$V_{EB} = 7\ V$			1	mA
$V_{CEO(sus)*}$	Collector-emitter Sustaining Voltage ($I_B = 0$)	$I_C = 100\ mA$				
		for BUW34	400			V
		for BUW35	400			V
		for BUW36	450			V
$V_{CE(sat)*}$	Collector-emitter Saturation Voltage	All Types $I_C = 5\ A$			1.5	V
		$I_B = 1\ A$				
		for BUW35 $I_C = 8\ A$			1.5	V
		$I_B = 2.5\ A$				
		for BUW36 $I_C = 8\ A$			3	V
		$I_B = 2.5\ A$				
$V_{BE(sat)*}$	Base-emitter Saturation Voltage	All Types $I_C = 5\ A$			1.5	V
		$I_B = 1\ A$				
		for BUW35 $I_C = 8\ A$			1.8	V
		$I_B = 2.5\ A$				
		for BUW36 $I_C = 8\ A$			1.8	V
		$I_B = 2.5\ A$				

RESISTIVE SWITCHING TIMES (see fig. 1)

Symbol	Parameter	Test Conditions	Min.	Typ.	Max.	Unit
t_{on}	Turn-on Time	$I_C = 5\ A, I_{B1} = 1\ A, V_{CC} = 250\ V$			0.70	μs
t_s	Storage Time	$I_C = 5\ A, I_{B1} = 1\ A, V_{CC} = 250\ V$			3	μs
t_f	Fall Time	$I_{B2} = -1\ A$			0.8	μs

INDUCTIVE SWITCHING TIMES (see fig. 2)

Symbol	Parameter	Test Conditions	Min.	Typ.	Max.	Unit
t_f	Fall Time	$I_C = 5\ A$ $I_{B1} = 1\ A$			0.3	μs
		$V_{BE} = -5\ V$ $V_{CC} = 300\ V$				
		$T_{case} = 100\ ^{\circ}C$				
		$I_C = 5\ A$ $I_{B1} = 1\ A$			0.6	μs
		$V_{BE} = -5\ V$ $V_{CC} = 300\ V$				

* Pulsed : pulse duration $\leq 300\ \mu s$, duty cycle $\leq 1.5\ \%$.

Safe Operating Areas.

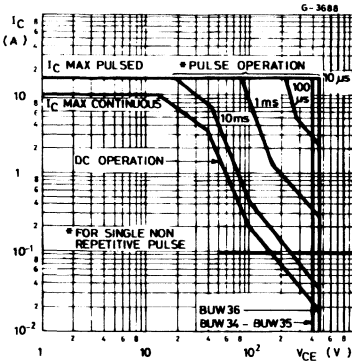

Clamped Reverse Bias Safe Operating Areas.

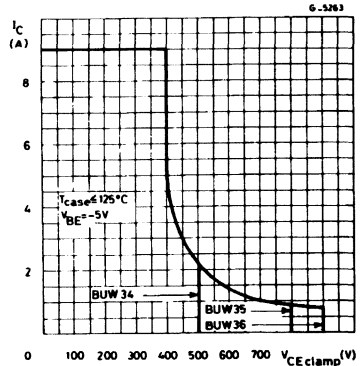

Forward Biased Accidental Overload Area (see fig. 3).

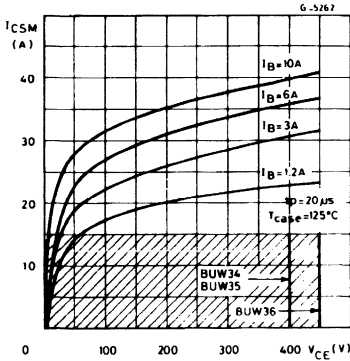

Derating Curves.

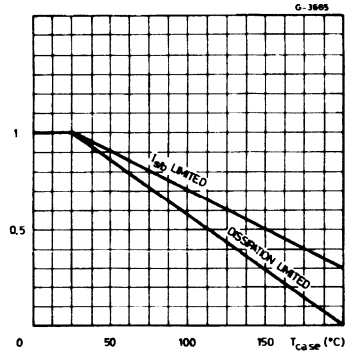

Transient Thermal Response.

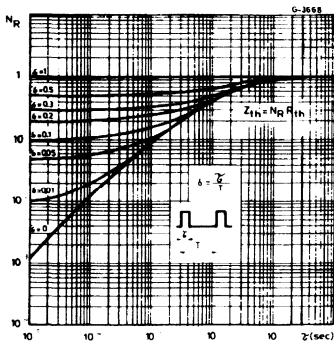

DC Current Gain.

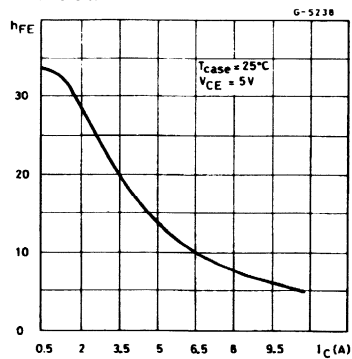

Saturation Voltages.

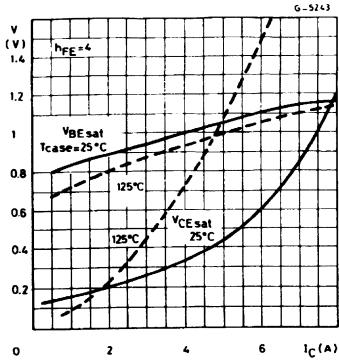

Collector-emitter Saturation Voltage.

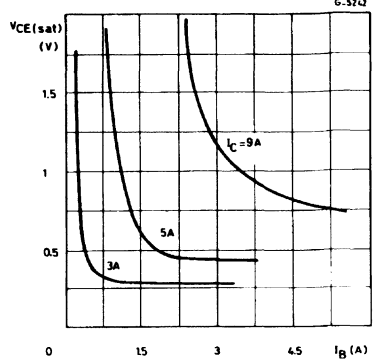

Collector Current Spread vs. Base Emitter Voltage.

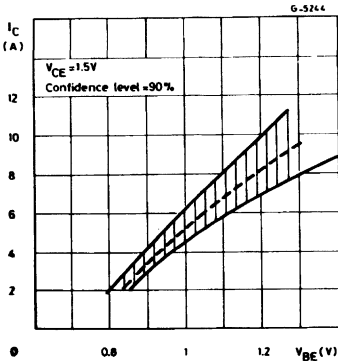

Switching Time Percentage Variation vs. case Temperature.

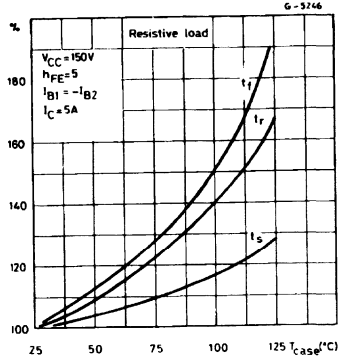

Switching Times Resistive Load (see fig. 1).

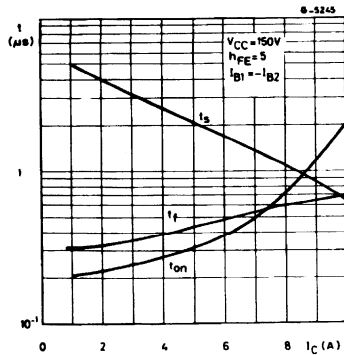

Switching Time Inductive Load (see fig. 2).

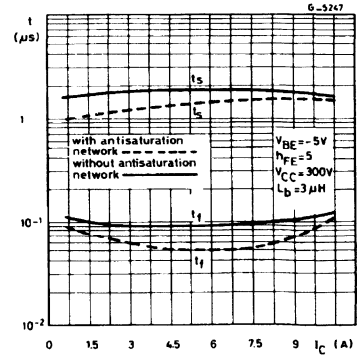

Switching Time Inductive Load vs. Case Temperature.

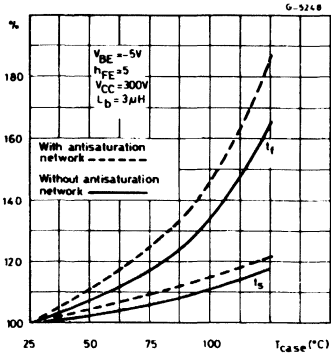

Fall Times vs. L_b (see fig. 2).

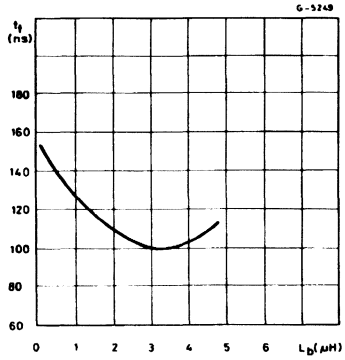

Dynamic Collector-emitter Saturation Voltage (see fig. 4).

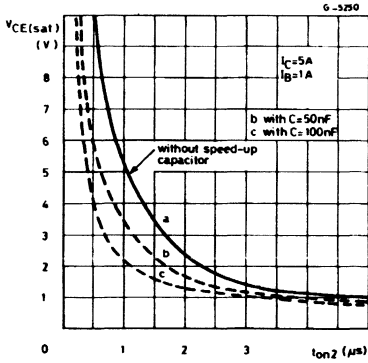

Figure 1 : Switching Times Test Circuit on resistive Load.

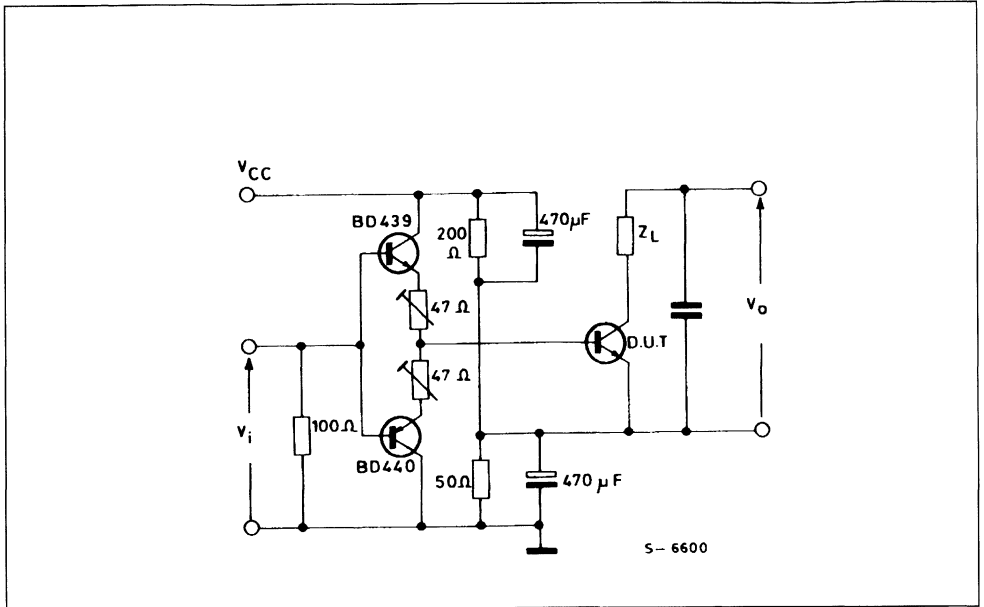

Figure 2 : Switching Times Test Circuit on Inductive Load with Ad without Antisaturation Network.

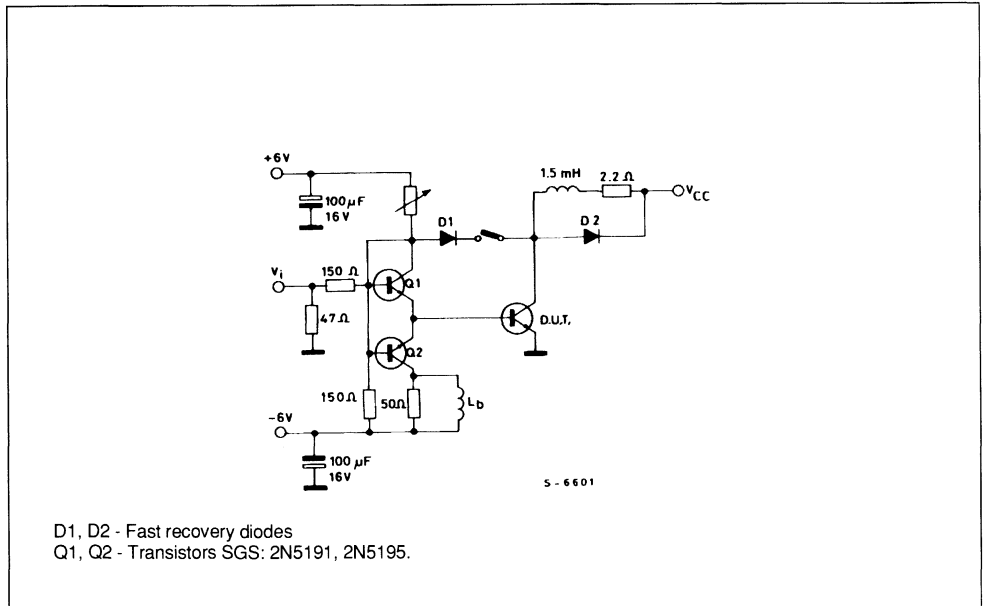

Figure 3 : Forward Biased Accidental Over Load Area Test Circuit.

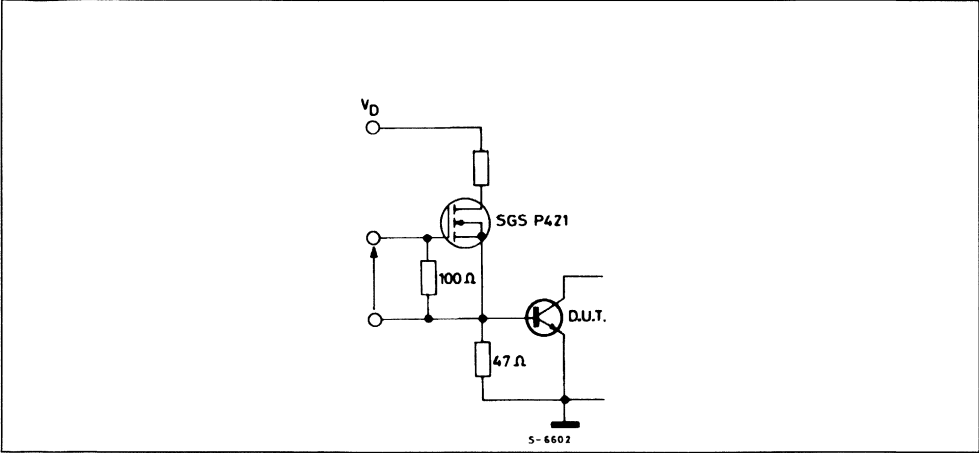

Figure 4 : V_{CE (sat)} Dyn. Test Circuit.

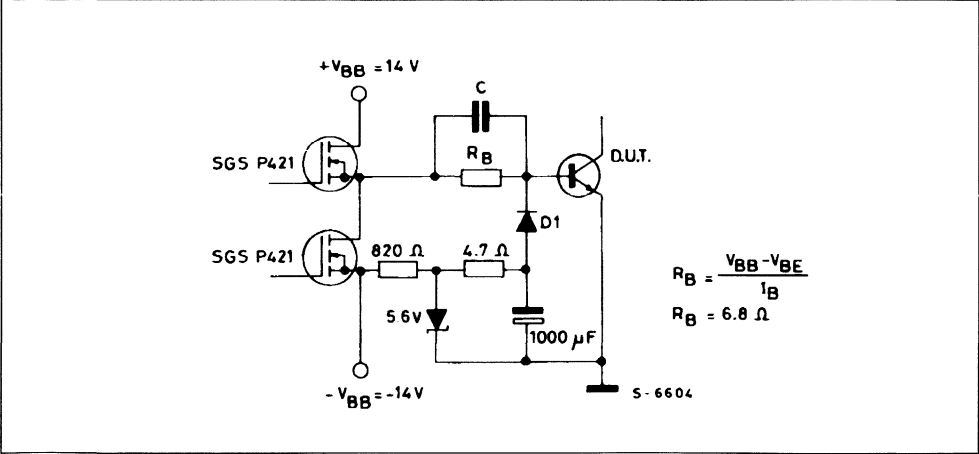

Figure 5 : Equivalent Input Schematic at Turn-on.

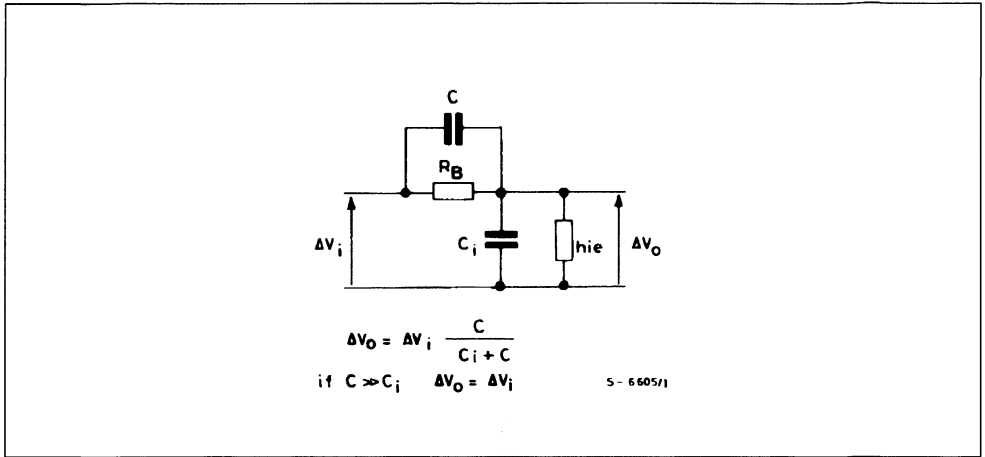
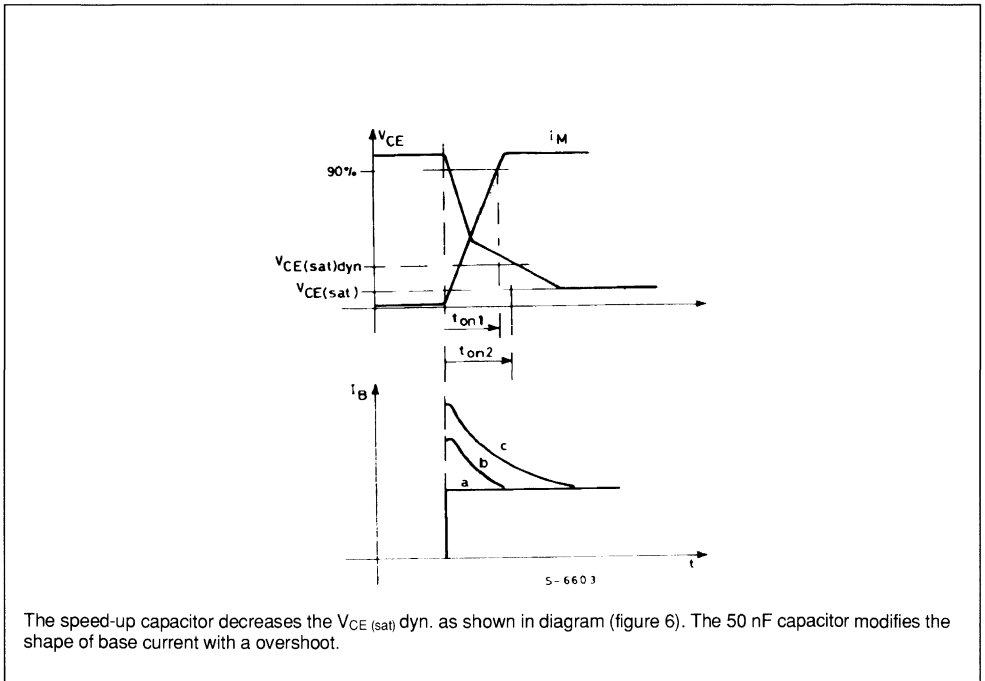
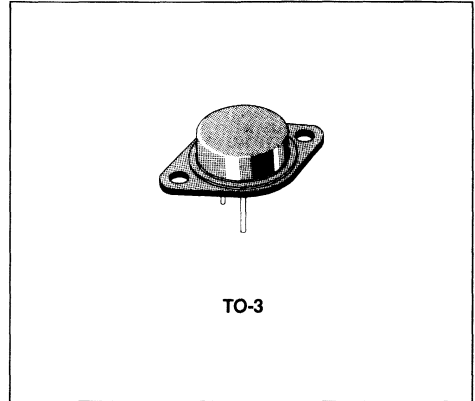

Figure 6 : Remarks to $V_{CE(sat)}$ Dyn. Test Circuit (fig. 4).



NPN HIGH CURRENT SWITCHING POWER TRANSISTORS

- HIGH CURRENT CAPABILITY
- VERY LOW SATURATION VOLTAGE AT $I_C = 20\text{ A}$
- FAST TURN-OFF AND TURN-ON
- HIGH FREQUENCY AND EFFICIENCY CONVERTERS
- SWITCHING REGULATORS
- MOTOR CONTROLS



INTERNAL SCHEMATIC DIAGRAM

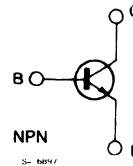

DESCRIPTION

High current, high speed transistors suited for low voltage applications.

ABSOLUTE MAXIMUM RATINGS

Symbol	Parameter	Value		Unit
		BUW38	BUW39	
V_{CBO}	Collector-base Voltage ($I_E = 0$)	120	160	V
V_{CEO}	Collector-emitter Voltage ($I_B = 0$)	60	80	V
V_{EBO}	Emitter-base Voltage ($I_C = 0$)	7	7	V
I_C	Collector Current	30	30	A
I_{CM}	Collector Peak Current ($t_p < 5\text{ms}$)	45	40	A
I_B	Base Current	8	6	A
I_{BM}	Base Peak Current ($t_p < 5\text{ms}$)	20	15	A
P_{Tot}	Total Dissipation at $T_c < 25^\circ\text{C}$	150		W
T_{stg}	Storage Temperature	- 65 to 200		$^\circ\text{C}$
T_j	Max. Operating Junction Temperature	200		$^\circ\text{C}$

THERMAL DATA

R _{thj-case}	Thermal Resistance Junction-case	max	1.17	°C/W
-----------------------	----------------------------------	-----	------	------

ELECTRICAL CHARACTERISTICS (T_{case} = 25°C unless otherwise specified)

Symbol	Parameter	Test Conditions	Min.	Typ.	Max.	Unit
I _{CEX}	Collector Cutoff Current	V _{CE} = V _{CEX} V _{BE} = - 1.5V V _{CE} = V _{CEX} V _{BE} = - 1.5V T _c = 100°C			1 3	mA mA
I _{EBO}	Emitter Cutoff Current (I _C = 0)	V _{EB} = 5V			1	mA
V _{CEO(sus)*}	Collector Emitter Sustaining Voltage	I _C = 0.2A L = 25mH for BUW38 for BUW39	60 80			V V
V _{EBO}	Emitter-base Voltage (I _C = 0)	I _E = 50mA	7			V
V _{CE(sat)*}	Collector-emitter Saturation Voltage	I _C = 20A I _B = 2A for BUW38 I _C = 40A I _B = 4A for BUW38 I _C = 15A I _B = 1.5A for BUW39 I _C = 30A I _B = 3A for BUW39			0.6 1.4 0.5 1.2	V V V V
V _{BE(sat)*}	Base-emitter Saturation Voltage	I _C = 40A I _B = 4A for BUW38 I _C = 30A I _B = 3A for BUW39			2.1 2	V V
f _T	Transtion Frequency	f = 10MHz V _{CE} = 15A I _C = 1A	8			MHz

RESISTIVE LOAD

Symbol	Parameter	Test Conditions	Min.	Typ.	Max.	Unit
t _{on}	Turn-on Time	for BUW38		1.2	1.5	μs
t _s	Storage Time	V _{CC} = 60V I _C = 40A		0.6	1.1	μs
t _f	Fall Time	I _{B1} = - I _{B2} = 4A		0.17	0.25	μs
t _s	Storage Time	for BUW38			1.65	μs
t _f	Fall Time	V _{CC} = 60V I _C = 40A I _{B1} = - I _{B2} = 4A T _c = 125°C			0.5	μs
t _{on}	Turn-on Time	for BUW39		0.8	1.2	μs
t _s	Storage Time	V _{CC} = 80V I _C = 30A		0.6	1.1	μs
t _f	Fall Time	I _{B1} = - I _{B2} = 3A		0.15	0.25	μs
t _s	Storage Time	for BUW39			1.65	μs
t _f	Fall Time	V _{CC} = 80V I _C = 30A I _{B1} = - I _{B2} = 3A T _c = 125°C			0.5	μs

* Pulsed : Pulse duration = 300 μs, duty cycle = 2 %.

DC and AC Pulse Area.

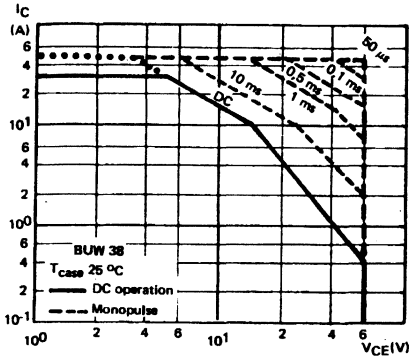

DC and AC Pulse Area.

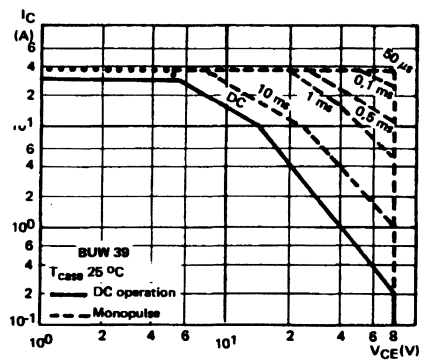

Power and $I_{S/B}$ Derating vs. Case Temperature.

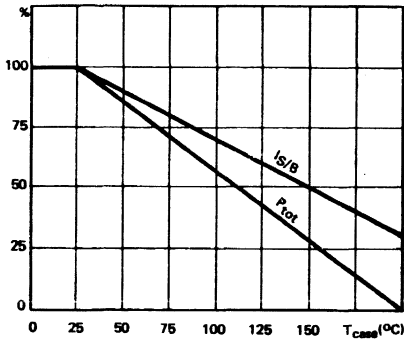

Transient Thermal Response.

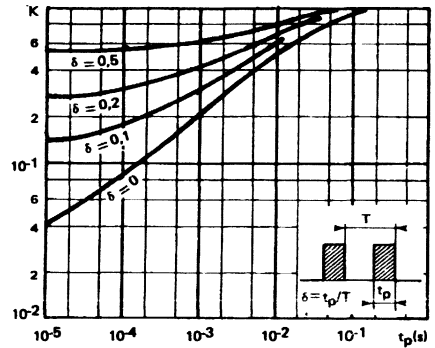

Collector-emitter Voltage vs. Base-emitter Resistance.

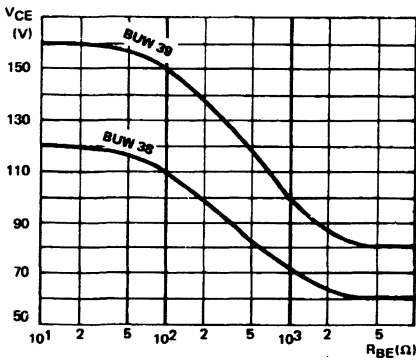

DC Current Gain.

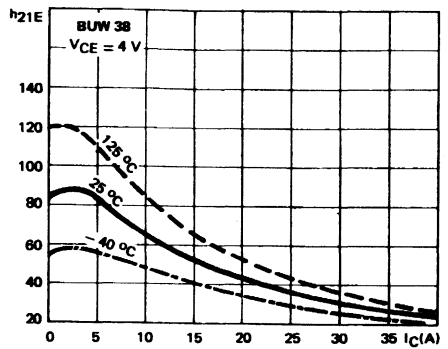

Minimum Base Current to Saturate the Transistor.

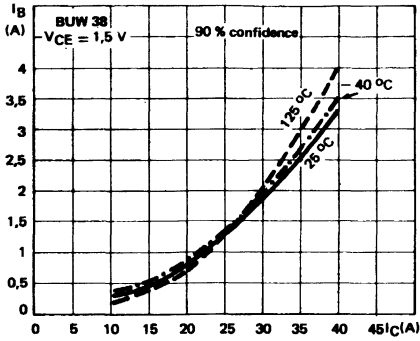

Base Characteristics.

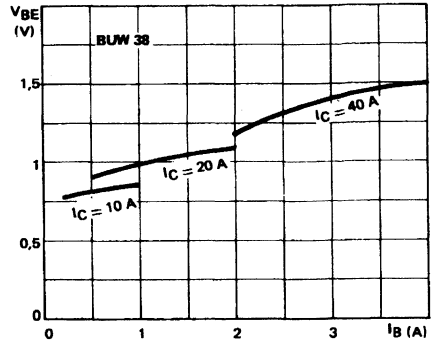

Collector Saturation Region.

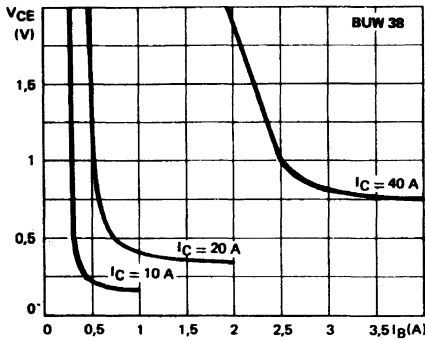

Saturation Voltages.

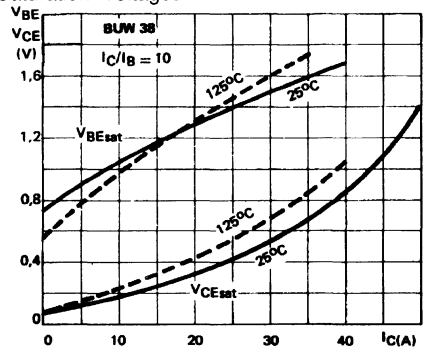

Collector Current Spread vs. Base Emitter Voltage.

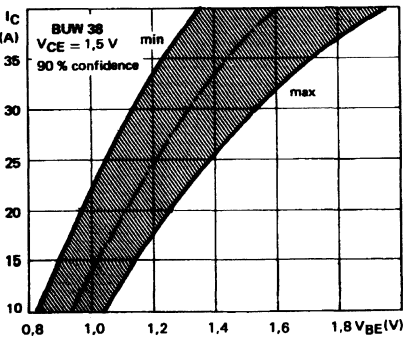

DC Current Gain.

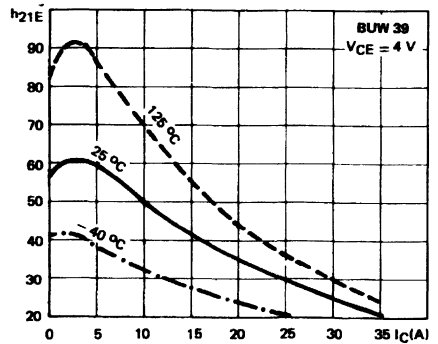

Minimum Base Current to saturate the Transistor.

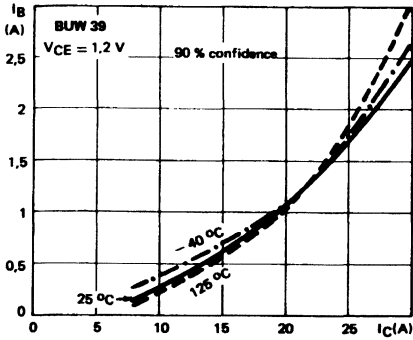

Base Characteristics.

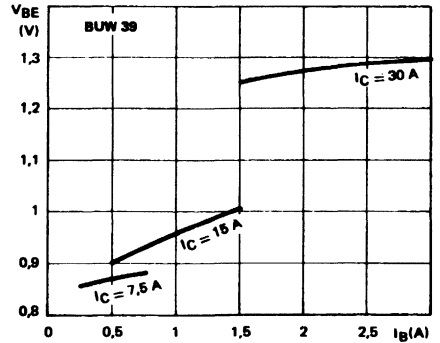

Collector Saturation Region.

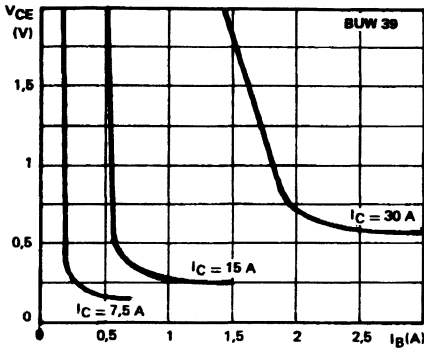

Saturation Voltages.

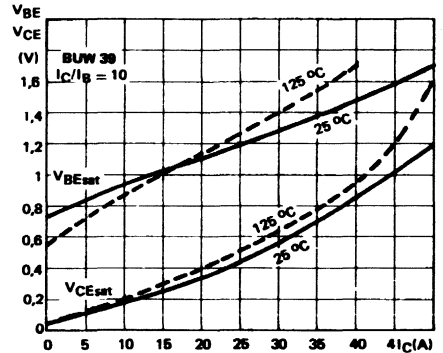

Collector Current Spread vs. Base Emitter Voltage.

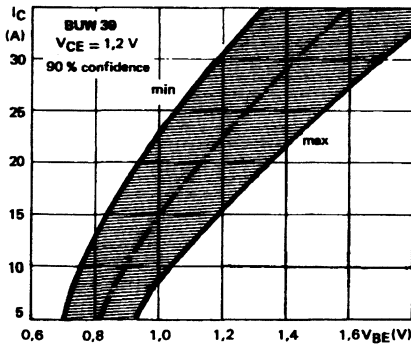

SWITCHING OPERATING AND OVERLOAD AREAS

TRANSISTOR FORWARD BIASED

- During the turn on
- During the turn off without negative base-emitter voltage and $R_{BE} \geq 5\Omega$

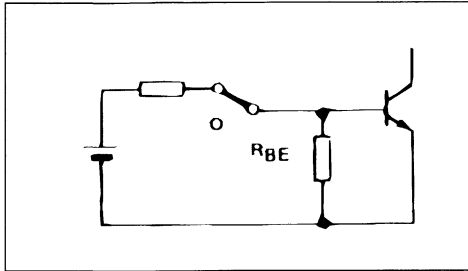

TRANSISTOR REVERSE BIASED

- During the turn off without negative base-emitter voltage

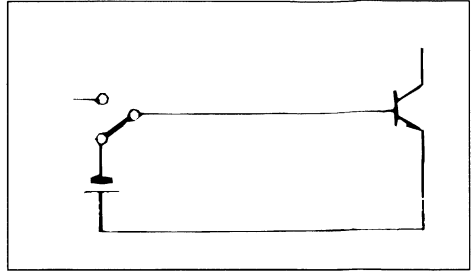

Forward Biased Safe Operating Area (FBSOA).

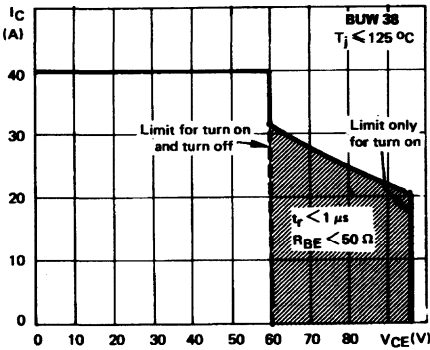

The hatched zone can only be used for turn-on.

Reverse Biased Safe Operating Area (RBSOA).

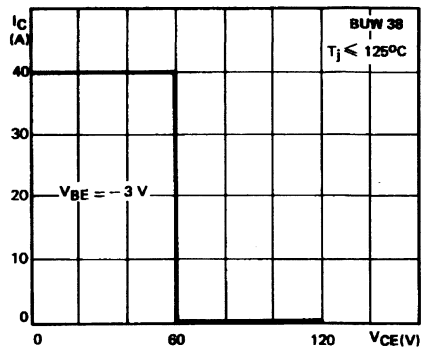

Forward Biased Accidental Overload Area (FBAOA).

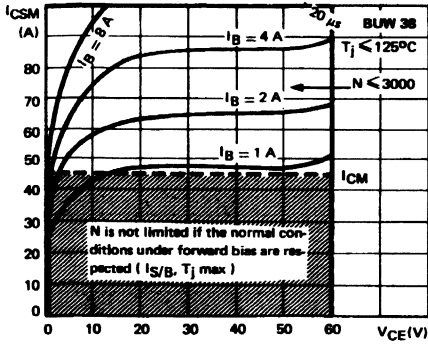

The Kellogg network (heavy print) allows the calculation of the maximum value of the short circuit current for a given base current I_B (90% confidence). High accidental surge currents ($I > I_{CM}$) are allowed if they are non repetitive and applied less than 3000 times during the component life.

Forward Biased Safe Operating Area (FBSOA).

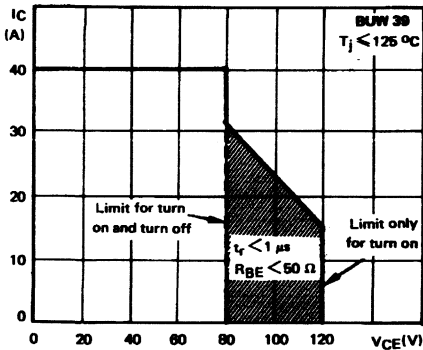

The hatched zone can only be used for turn-on.

Reverse Biased Accidental Overload Area (RBAOA).

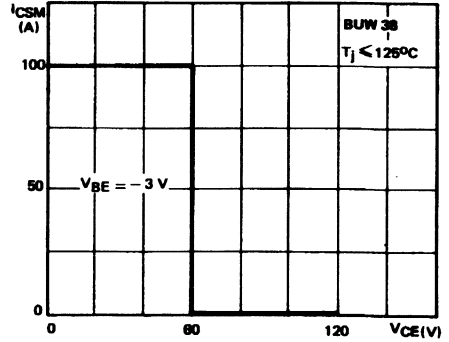

After the accidental overload current, the RBAOA has to be used for the turn off.

Reverse Biased Safe Operating Area (RBSOA).

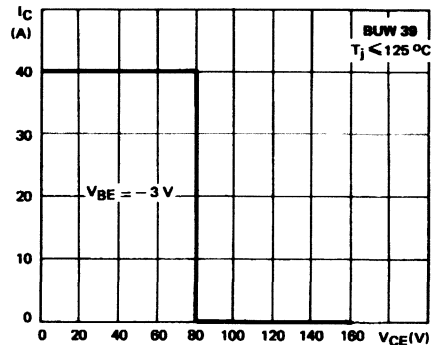

Forward Biased Accidental Overload Area (FBAOA).

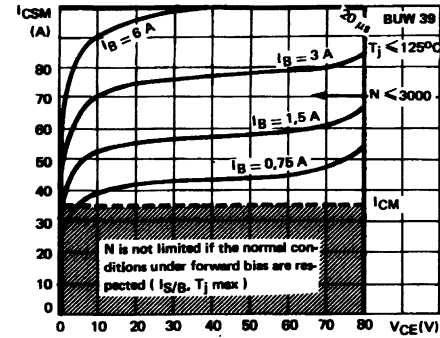

Reverse Biased Accidental Overload Area (RBAOA).

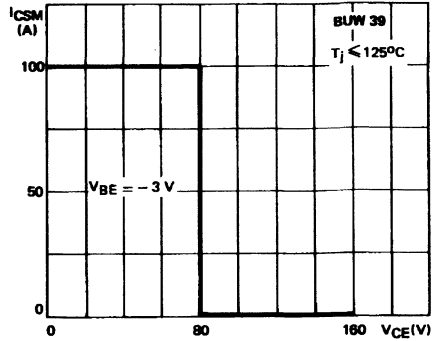

The Kellog network (heavy print) allows the calculation of the maximum value of the short-circuit current. High accidental surge currents ($I > I_{CM}$) are allowed if they are non repetitive and applied less than 3000 times during the component life.

rent for a given base current I_B (90% confidence).

Switching Times vs. Collector Current (resistive load).

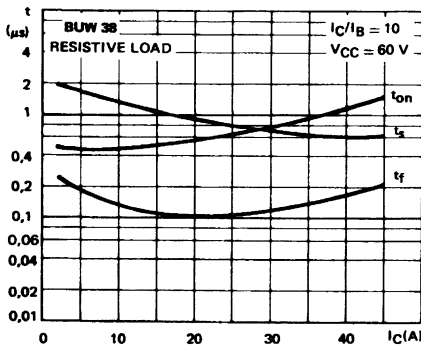

Switching Times vs. Collector Current (resistive load).

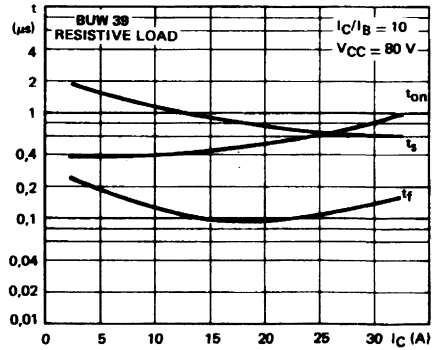

Switching Times vs. Junction Temperature.

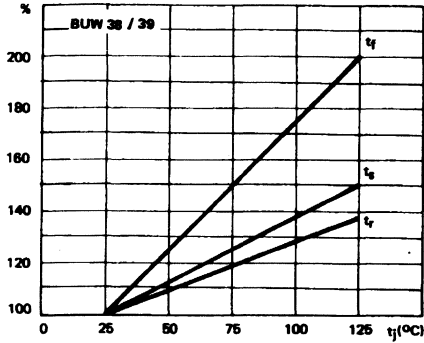

Switching Times vs. Collector Current (inductive load).

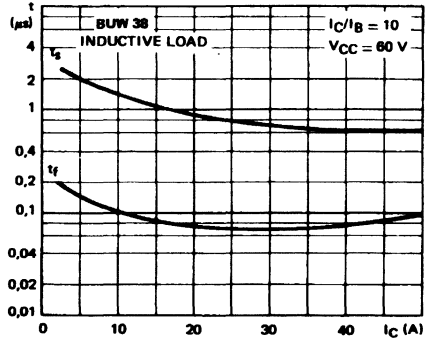

Switching Times vs. Collector Current (inductive load).

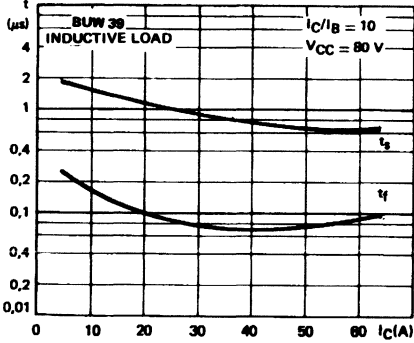

HIGH VOLTAGE POWER SWITCH

DESCRIPTION

The BUW42/A, BUW42P/42AP and BUW42PFI/APFI are silicon multiepitaxial mesa PNP transistors mounted respectively in TO-3 metal case, TO-218 plastic package and ISOWATT218 fully isolated package.

They are intended in fast switching applications for high output power.

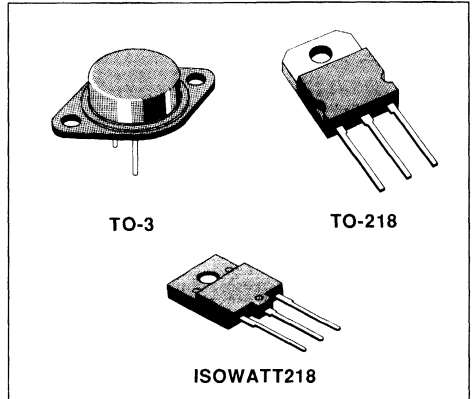

INTERNAL SCHEMATIC DIAGRAM

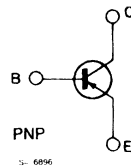

ABSOLUTE MAXIMUM RATINGS

Symbol	Parameter	BUW			Unit
		42/P/PFI	42A/AP/APFI		
V_{CES}	Collector-emitter Voltage ($V_{BE} = 0$)	- 400	- 450		V
V_{CEO}	Collector-emitter Voltage ($I_B = 0$)	- 350	- 400		V
V_{EBO}	Emitter-base Voltage ($I_C = 0$)	- 7			V
I_C	Collector Current	- 15			A
I_{CM}	Collector Peak Current	- 30			A
I_B	Base Current	- 10			A
		TO-3	TO-218	ISOWATT218	
P_{tot}	Total Dissipation at $T_c < 25^\circ\text{C}$	150	105	65	W
T_{stg}	Storage Temperature	- 65 to 175	- 65 to 150	- 65 to 150	$^\circ\text{C}$
T_j	Max. Operating Junction Temperature	175	150	150	$^\circ\text{C}$

THERMAL DATA

			TO-3	SOT-93	ISOWATT218	Unit
$R_{th\ j-case}$	Thermal Resistance Junction-case	Max	1.2	1.2	1.92	°C/W

ELECTRICAL CHARACTERISTICS ($T_{case} = 25^{\circ}C$ unless otherwise specified)

Symbol	Parameter	Test Conditions	Min.	Typ.	Max.	Unit
I_{CES}	Collector Cutoff Current ($V_{BE} = 0$)	$V_{CE} = -400V$ for BUW42/P/PFI $V_{CE} = -450V$ for BUW42A/AP/APFI			- 1	mA
I_{EBO}	Emitter Cutoff Current	$V_{EB} = -5V$ for BUW42/P/PFI $V_{EB} = -7V$ for BUW42A/AP/APFI			- 1	mA
$V_{CE0(sus)}$ *	Collector-emitter Sustaining Voltage ($I_B = 0$)	$I_C = -100mA$ for BUW42/P/PFI for BUW42A/AP/APFI	- 350 - 400			V V
$V_{CE(sat)}$ *	Collector-emitter Saturation Voltage	$I_C = -10A$ $I_B = -3A$			- 1.5	V
$V_{BE(sat)}$ *	Base-emitter Saturation Voltage	$I_C = -10A$ $I_B = -3A$			- 2	V
h_{FE} *	DC Current Gain	$I_C = -3A$ $V_{CE} = -5V$	12		80	
t_{on} t_s t_f	RESISTIVE LOAD Turn-on Time Storage Time Fall Time	$V_{CC} = -250V$ $I_C = -10A$ $I_{B1} = -I_{B2} = -3.3A$		0.3 0.5 0.3	0.6 1.5 0.6	μs μs μs

* Pulsed : pulse duration = 300 μs , duty cycle = 1.5%.

Safe Operating Areas.
(TO-3).

Safe Operating Areas.
(TO-218, ISOWATT218).

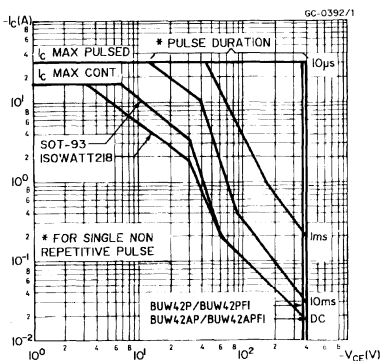
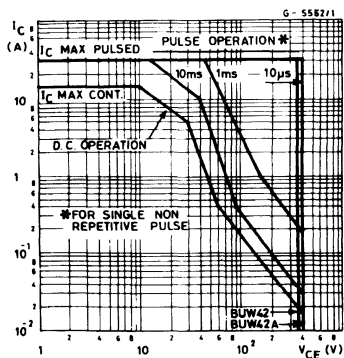

DC Current Gain.

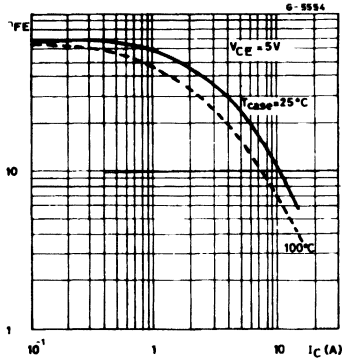

DC Current Gain.

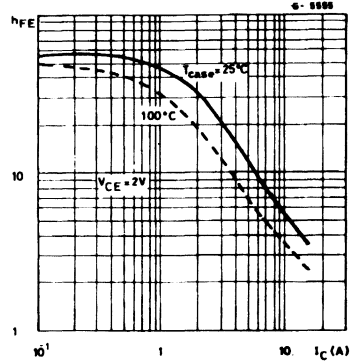

Base-emitter Saturation Voltage.

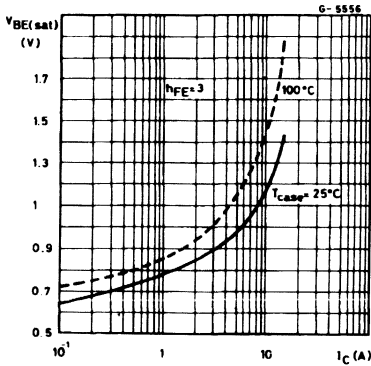

Collector-emitter Saturation Voltage.

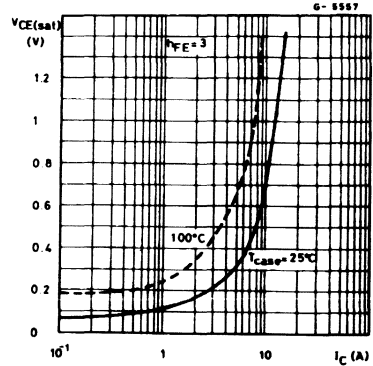

Collector-emitter Saturation Voltage.

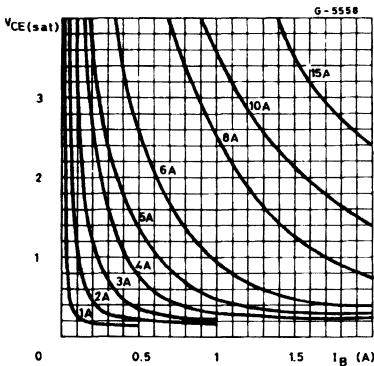

Saturated Switching-times Resistive Load.

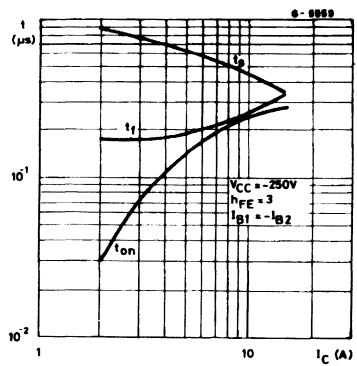

Switching Times Percentage Variation vs. T_{case} Resistive Load.

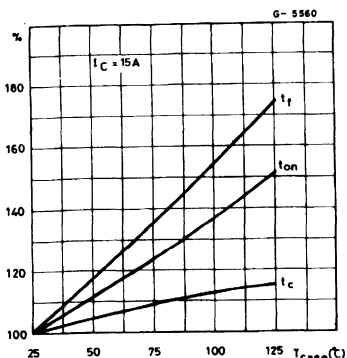

Clamped Reverse Bias Safe Operating Areas.

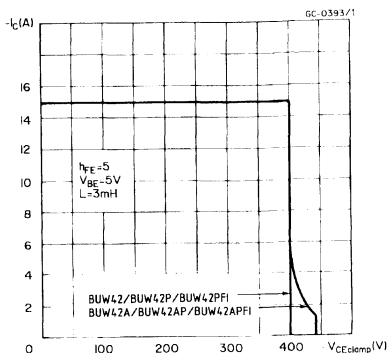

ISOWATT218 PACKAGE CHARACTERISTICS AND APPLICATION.

ISOWATT218 is fully isolated to 4000V dc. Its thermal impedance, given in the data sheet, is optimised to give efficient thermal conduction together with excellent electrical isolation. The structure of the case ensures optimum distances between the pins and heatsink. These distances are in agreement with VDE and UL creepage and clearance standards. The ISOWATT218 package eliminates the need for external isolation so reducing fixing hardware.

The package is supplied with leads longer than the standard TO-218 to allow easy mounting on pcbs. Accurate moulding techniques used in manufacture

assures consistent heat spreader-to-heatsink capacitance.

ISOWATT218 thermal performance is equivalent to that of the standard part, mounted with a 0.1 mm mica washer. The thermally conductive plastic has a higher breakdown rating and is less fragile than mica or plastic sheets. Power derating for ISOWATT218 packages is determined by :

$$P_D = \frac{T_j - T_c}{R_{th}}$$

THERMAL IMPEDANCE OF ISOWATT218 PACKAGE

Figure 3 illustrates the elements contributing to the thermal resistance of a transistor heatsink assembly, using ISOWATT218 package.

The total thermal resistance $R_{th(tot)}$ is the sum of each of these elements. The transient thermal impedance, Z_{th} for different pulse durations can be estimated as follows :

- 1- For a short duration power pulse of less than 1ms :
 $Z_{th} < R_{thJ-C}$
- 2 - For an intermediate power pulse of 5ms to 50ms seconds :
 $Z_{th} = R_{thJ-C}$

- 3 - For long power pulses of the order of 500ms seconds or greater :

$$Z_{th} = R_{thJ-C} + R_{thC-HS} + R_{thHS-amb}$$

It is often possible to discern these areas on transient thermal impedance curves.

Figure 3.

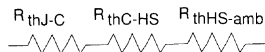

HIGH VOLTAGE, HIGH CURRENT POWER SWITCH

DESCRIPTION

The BUW44, BUW45 and BUW46 are multi-epitaxial mesa NPN transistors in Jedec TO-3 metal case intended in fast switching applications for high output powers.

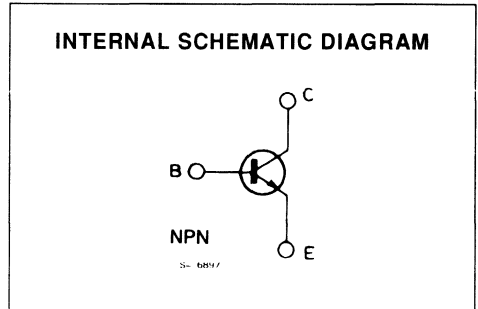
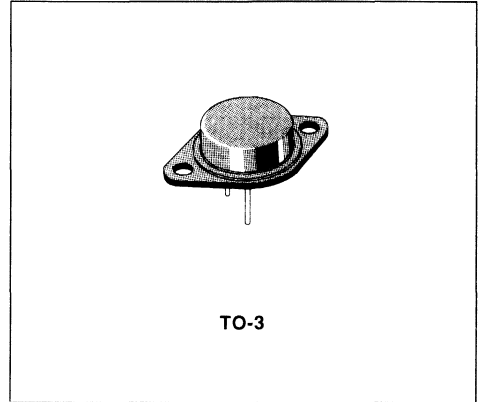

ABSOLUTE MAXIMUM RATINGS

Symbol	Parameter	Value			Unit
		BUW44	BUW45	BUW46	
V_{CES}	Collector-emitter Voltage ($V_{BE} = 0$)	500	800	900	V
V_{CEO}	Collector-emitter Voltage ($I_B = 0$)	400	400	450	V
V_{EBO}	Emitter-base Voltage ($I_C = 0$)	7			V
I_C	Collector Current	15			A
I_{CM}	Collector Peak Current	30			A
I_B	Base Current	10			A
P_{tot}	Total Power Dissipation at $T_{case} \leq 25^\circ\text{C}$	175			W
T_{stg}	Storage Temperature	- 65 to 200			$^\circ\text{C}$
T_j	Junction Temperature	200			$^\circ\text{C}$

THERMAL DATA

R _{thj-case}	Thermal Resistance Junction-case	max	1	°C/W
-----------------------	----------------------------------	-----	---	------

ELECTRICAL CHARACTERISTICS (T_{case} = 25°C unless otherwise specified)

Symbol	Parameter	Test Conditions	Min.	Typ.	Max.	Unit
I _{CEs}	Collector Cutoff Current (V _{BE} = 0)	for BUW44 V _{CE} = 500V for BUW45 V _{CE} = 800V for BUW46 V _{CE} = 900V T _{case} = 125°C for BUW44 V _{CE} = 500V for BUW45 V _{CE} = 800V for BUW46 V _{CE} = 900V			500 500 500 3 3 3	μA μA μA mA mA mA
I _{EBO}	Emitter Cutoff Current (I _C = 0)	V _{EB} = 7V			1	mA
V _{CEO(sus)} *	Collector-emitter Sustaining Voltage	I _C = 100mA for BUW44 for BUW45 for BUW46	400 400 450			V V V
V _{CE(sat)} *	Collector-emitter Saturation Voltage	for BUW44 I _C = 10A I _B = 2A I _C = 6A I _B = 1A for BUW45 and BUW46 I _C = 10A I _B = 2A I _C = 7A I _B = 1A			3 1.5 1.5 1.5	V V V V
V _{BE(sat)} *	Base-emitter Saturation Voltage	for BUW44 I _C = 10A I _B = 2A I _C = 6A I _B = 1A for BUW45 and BUW46 I _C = 10A I _B = 2A I _C = 7A I _B = 1A			1.8 1.4 1.8 1.4	V V V V
t _{on}	Turn-on Time	I _C = 10A I _{B1} = 2A V _{CC} = 250V			0.75	μs
t _s	Storage Time	I _C = 10A I _{B1} = 2A			3	μs
t _f	Fall Time	I _{B2} = - 2A V _{CC} = 250V			0.8	μs

* Pulsed : pulse duration = 300 μs, duty cycle = 1.5 %.

Safe Operating Areas.

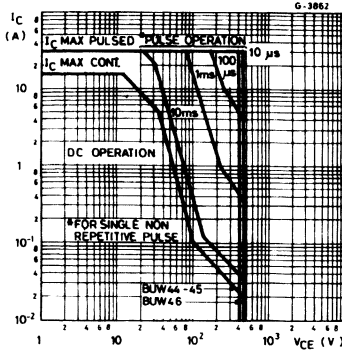

Thermal Transient Response.

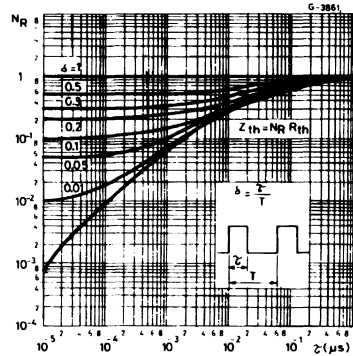

DC Current Gain.

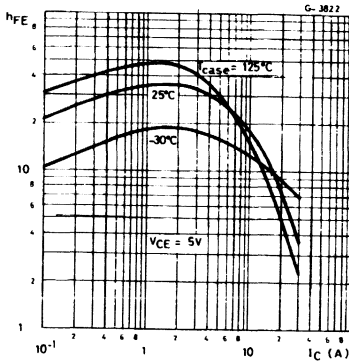

Collector-emitter Saturation Voltage.

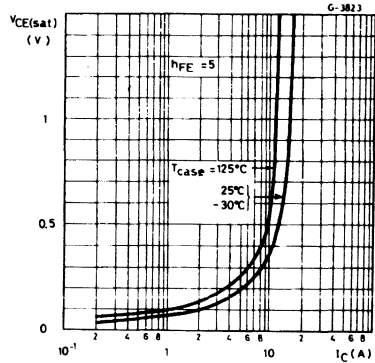

Collector-emitter Saturation Voltage.

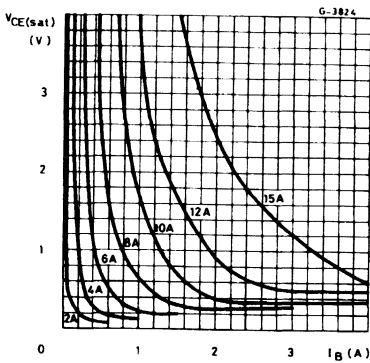

Base-emitter Saturation Voltage.

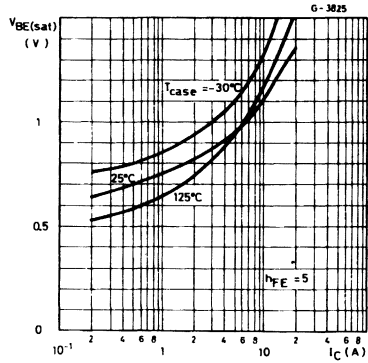

Saturated Switching Characteristics.

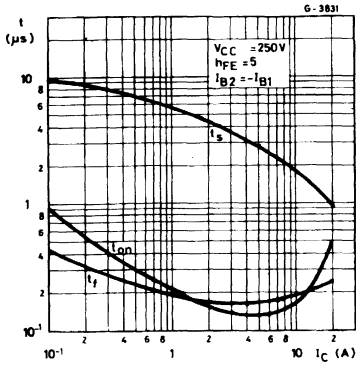

Clamped Reverse Bias Safe Operating Areas.

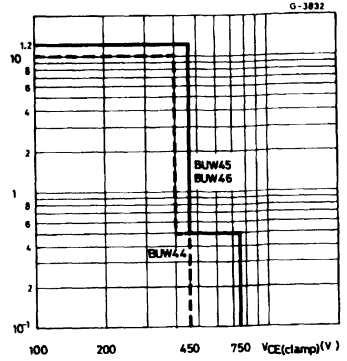

Clamped $E_{s/b}$ Test Circuit.

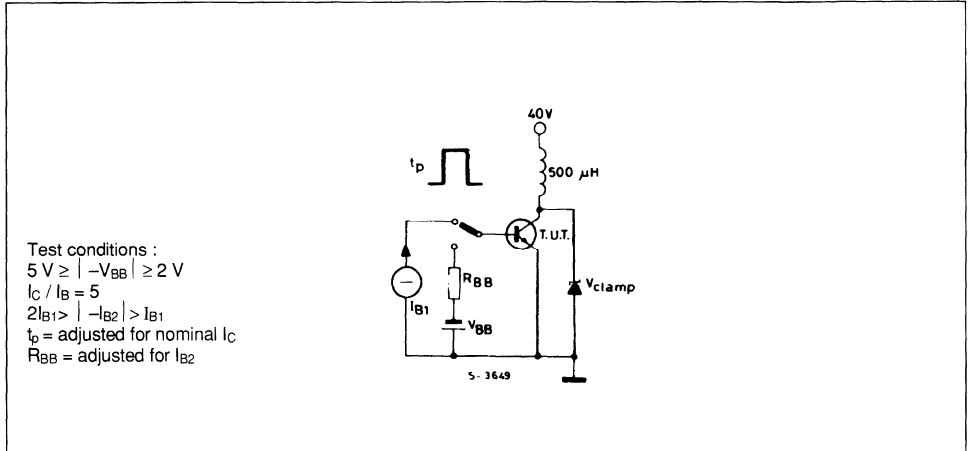

NPN HIGH CURRENT SWITCHING TRANSISTORS

- HIGH CURRENT CAPABILITY
- VERY LOW SATURATION VOLTAGE AT $I_C = 20A$
- FAST TURN-ON AND TURN-OFF

APPLICATIONS

- HIGH FREQUENCY AND EFFICIENCY CONVERTERS
- SWITCHING REGULATORS
- MOTOR CONTROLS

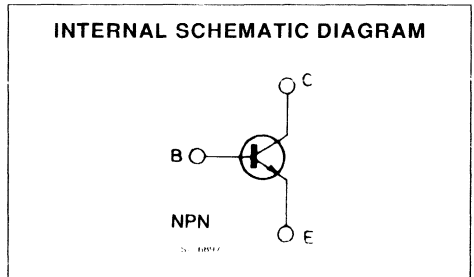
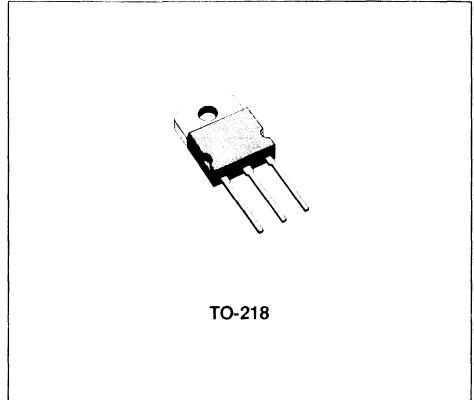

ABSOLUTE MAXIMUM RATINGS

Symbol	Parameter	Value		Unit
		BUW48	BUW49	
V_{CBO}	Collector-base Voltage ($I_E = 0$)	120	160	V
V_{CEO}	Collector-emitter Voltage ($I_B = 0$)	60	80	V
V_{EBO}	Emitter-base Voltage ($I_C = 0$)	7	7	V
I_C	Collector Current	30	30	A
I_{CM}	Collector Peak Current ($t_p < 10ms$)	45	40	A
I_B	Base Current	8	6	A
I_{BM}	Base Peak Current ($t_p < 10ms$)	12	10	A
P_{tot}	Total Dissipation at $T_C < 25^\circ C$	150		W
T_{stg}	Storage Temperature	- 65 to 175		$^\circ C$
T_j	Max. Operating Junction Temperature	175		$^\circ C$

THERMAL DATA

$R_{thj-case}$	Thermal Resistance Junction-case	Max	1	°C/W
----------------	----------------------------------	-----	---	------

ELECTRICAL CHARACTERISTICS ($T_{case} = 25^{\circ}C$ unless otherwise specified)

Symbol	Parameter	Test Conditions	Min.	Typ.	Max.	Unit
I_{CEX}	Collector Cutoff Current	$V_{CE} = V_{CEX}$ $V_{BE} = -1.5V$			1	mA
		$V_{CE} = V_{CEX}$ $V_{BE} = -1.5V$ $T_c = 125^{\circ}C$			3	mA
I_{EBO}	Emitter Cutoff Current ($I_C = 0$)	$V_{EB} = 5V$			1	mA
$V_{CEO(sus)}^*$	Collector Emitter Sustaining Voltage	$I_C = 0.2A$ $L = 25mH$ for BUW48 for BUW49	60			V
			80			V
V_{EBO}	Emitter-base Voltage ($I_C = 0$)	$I_E = 50mA$	7			V
$V_{CE(sat)}^*$	Collector-emitter Saturation Voltage	$I_C = 20A$ $I_B = 2A$ for BUW48			0.6	V
		$I_C = 40A$ $I_B = 4A$ for BUW48			1.4	V
		$I_C = 15A$ $I_B = 1.5A$ for BUW49			0.5	V
		$I_C = 30A$ $I_B = 3A$ for BUW49			1.2	V
$V_{BE(sat)}^*$	Base-emitter Saturation Voltage	$I_C = 40A$ $I_B = 4A$ for BUW48			2.1	V
		$I_C = 30A$ $I_B = 3A$ for BUW49			2	V
f_T	Transition Frequency	$I_C = 1A$ $V_{CE} = 15V$ $f = 1MHz$		8		MHz

RESISTIVE LOAD

Symbol	Parameter	Test Conditions	Min.	Typ.	Max.	Unit
t_{on}	Turn-on Time	for BUW48		1.2	1.5	μs
t_s	Storage Time	$V_{CC} = 60V$ $I_C = 40A$		0.6	1.1	μs
t_f	Fall Time	$I_{B1} = -I_{B2} = 4A$		0.17	0.25	μs
t_s	Storage Time	for BUW48			1.65	μs
		$V_{CC} = 60V$ $I_C = 40A$			0.5	μs
		$I_{B1} = -I_{B2} = 4A$				
t_{on}	Turn-on Time	for BUW49		0.8	1.2	μs
t_s	Storage Time	$V_{CC} = 80V$ $I_C = 30A$		0.6	1.1	μs
t_f	Fall Time	$I_{B1} = -I_{B2} = 3A$		0.15	0.25	μs
t_s	Storage Time	for BUW49			1.65	μs
		$V_{CC} = 80V$ $I_C = 30A$			0.5	μs
		$I_{B1} = -I_{B2} = 3A$				

* Pulsed : Pulse duration = 300 μs , duty cycle = 1.5%.

DC and Pulse Area.

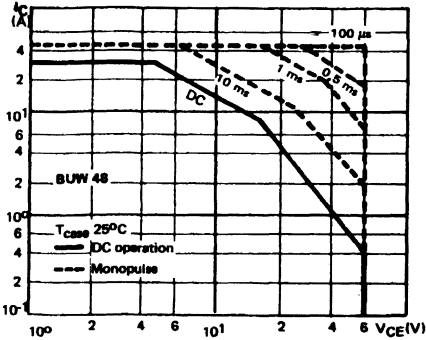

DC and Pulse Area.

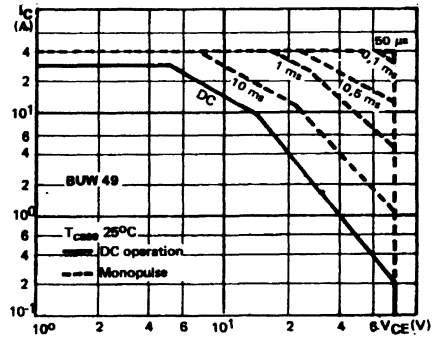

Power and $I_{S/B}$ Derating vs. Case Temperature.

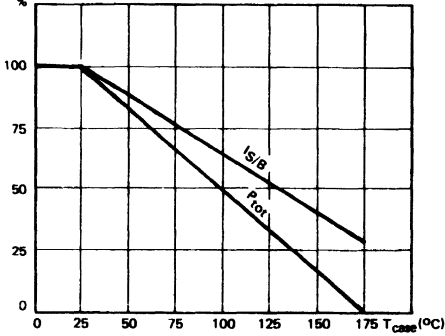

Transient Thermal Response.

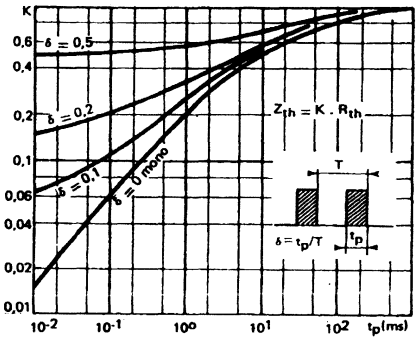

Collector-emitter Voltage vs. Base-emitter Resistance.

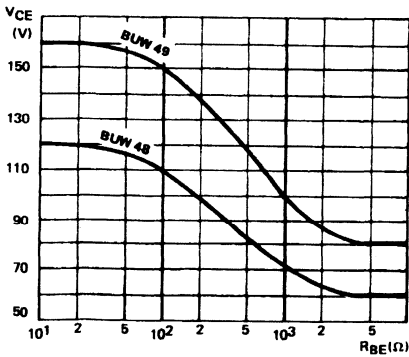

DC Current Gain.

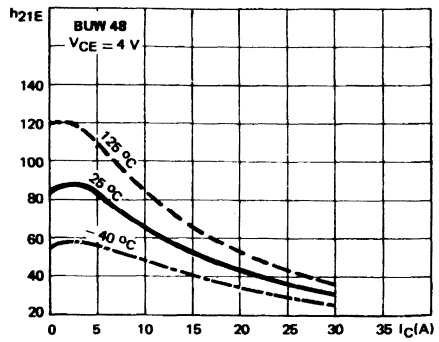

Minimum Base Current to Saturate the Transistor.

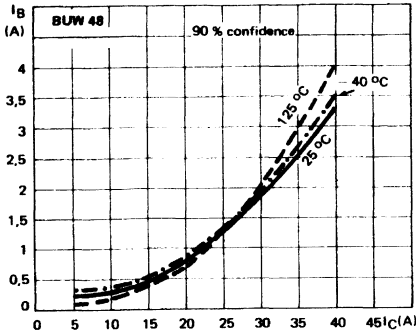

Base Characteristics.

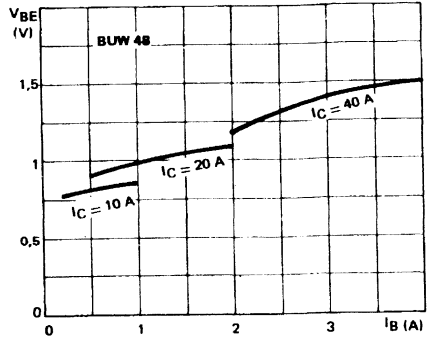

Collector Saturation Region.

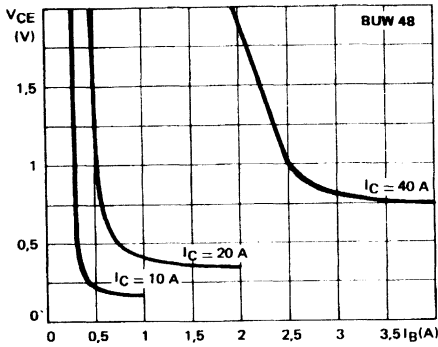

Saturation Voltage.

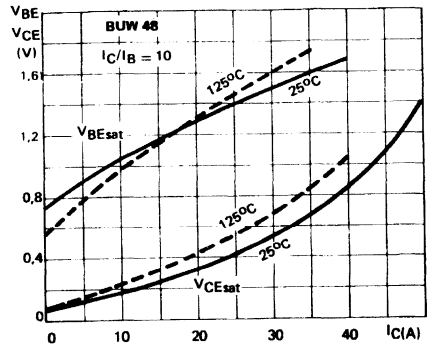

Collector Current Spread vs. Base Emitter Voltage.

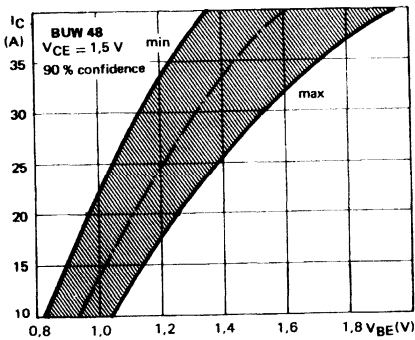

DC Current Gain.

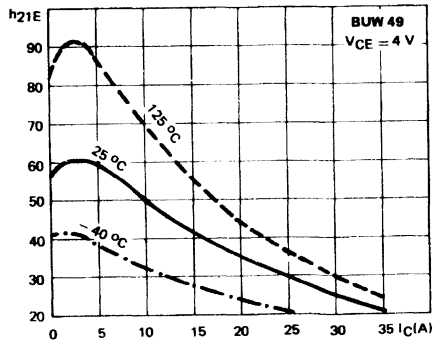

Minimum Base Current to saturate the Transistor.

Base Characteristics.

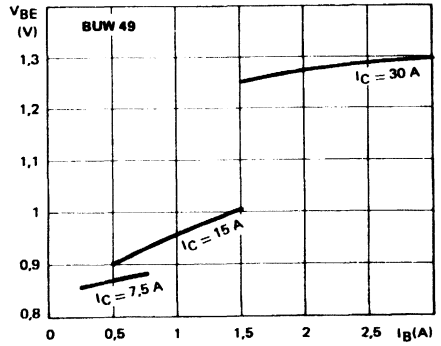
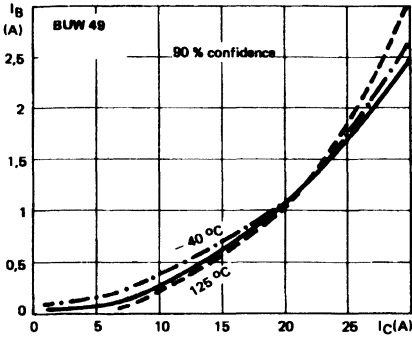

Collector Saturation Region.

Saturation Voltage.

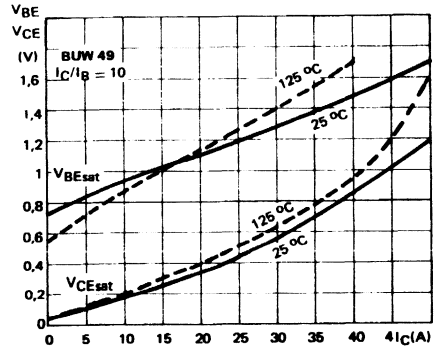
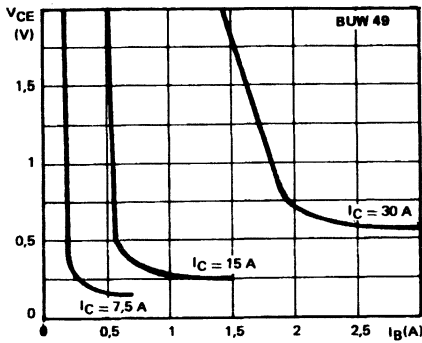

Collector Current Spread vs. Base Emitter Voltage.

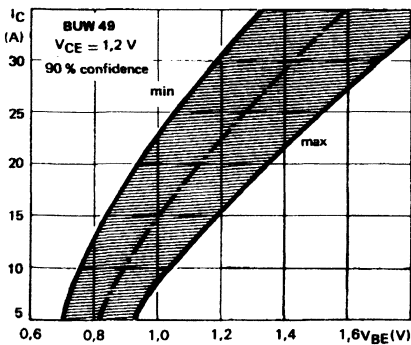

SWITCHING OPERATING AND OVERLOAD AREAS

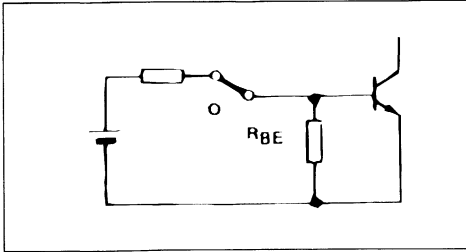

TRANSISTOR FORWARD BIASED

- During the turn on
- During the turn off without negative base-emitter voltage and $R_{BE} \geq 5\Omega$

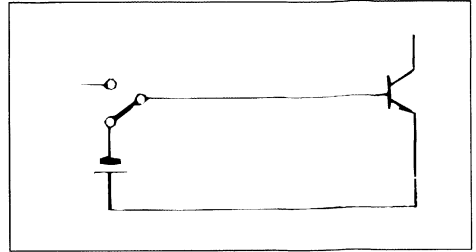

TRANSISTOR REVERSE BIASED

- During the turn off without negative base-emitter voltage

Forward Biased Safe Operating Area (FBSOA).

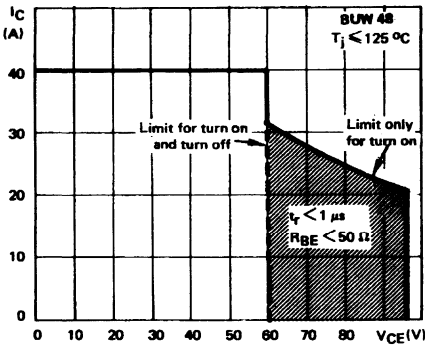

The hatched zone can only be used for turn on.

Forward Biased Accidental Overload Area (FBAOA).

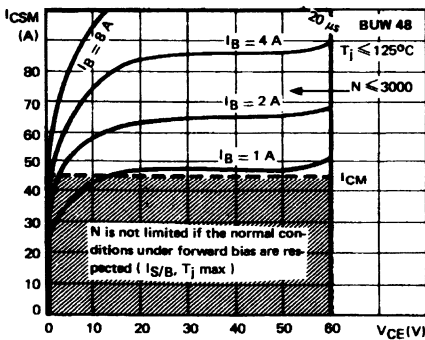

The Kellogg network (heavy print) allows the calculation of the maximum value of the short-circuit current for a given base current I_B (90% confidence).

High accidental surge currents ($I > I_{CM}$) are allowed if they are non repetitive and applied less than 3000 times during the component life.

Reverse Biased Safe Operating Area (RBSOA).

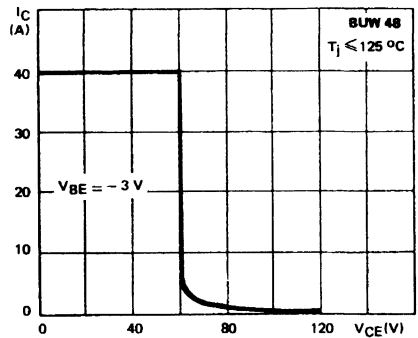

Reverse Biased Accidental Overload Area (RBAOA).

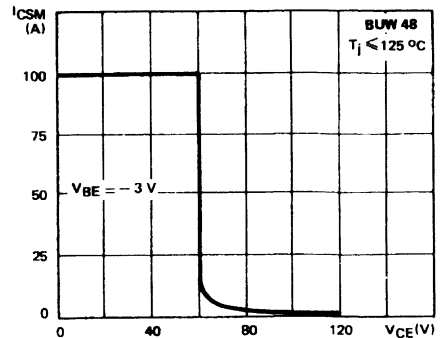

After the accidental overload current, the RBAOA has to be used for the turn off.

Forward Biased Safe Operating Area (FBSOA).

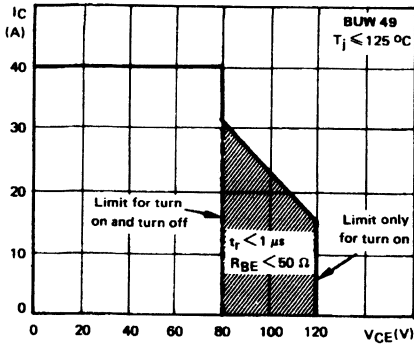

The hatched zone can only be used for turn on.

Figure 25 : Forward Biased Accidental Overload Area (FBAOA).

Reverse Biased Safe Operating Area (RBSOA).

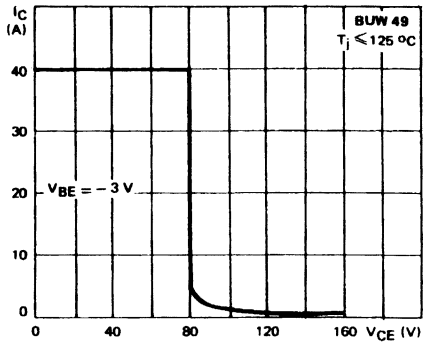
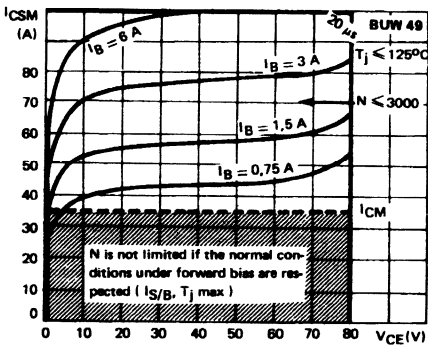
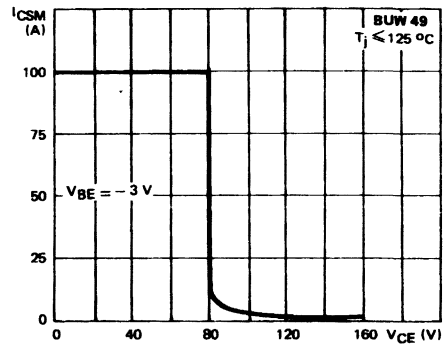

Figure 26 : Reverse Biased Accidental Overload Area (RBAOA).



The Kellog network (heavy print) allows the calculation of the maximum value of the short-circuit current for a given base current I_B (90% confidence).

High accidental surge currents ($I > I_{CM}$) are allowed if they are non repetitive and applied less than 3000 times during the component life.



After the accidental overload current, the RBAOA has to be used for the turn off.

Switching Times vs. Collector Current (resistive load).

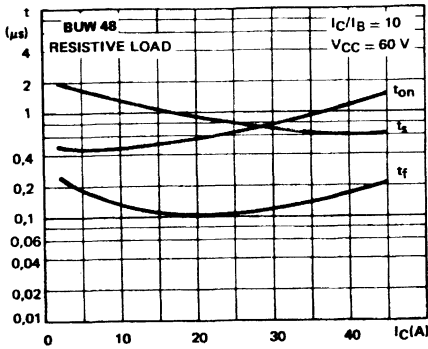

Switching Times vs. Junction Temperature.

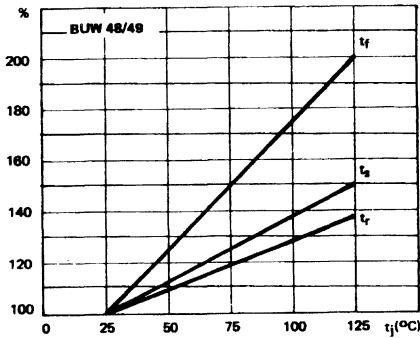

Switching Times vs. Collector Current (inductive load).

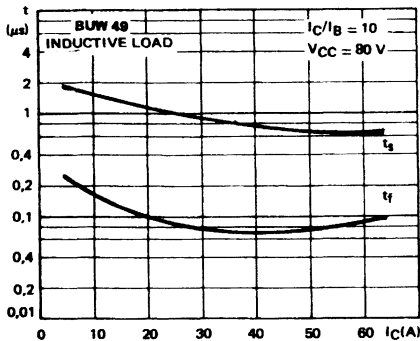

Switching Times vs. Collector Current (resistive load).

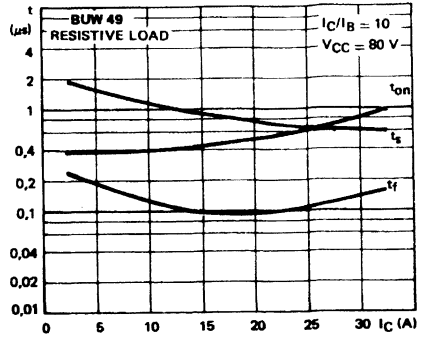

Switching Times vs. Collector Current (inductive load).

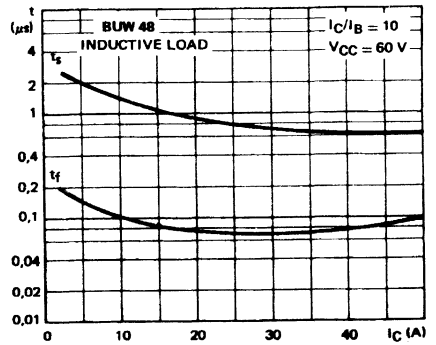

NPN FAST SWITCHING POWER TRANSISTOR

- VERY LOW SATURATION VOLTAGE AND HIGH GAIN FOR REDUCED LOAD OPERATION
- TURN-ON AND TURN-OFF TAIL SPECIFICATIONS
- TURN-ON di_C/dt FOR BETTER RECTIFIER CHOICE
- SWITCHING TIMES SPECIFIED WITH AND WITHOUT NEGATIVE BASE DRIVE
- FAST SWITCHING TIMES
- LOW SWITCHING LOSSES
- LOW ON-STATE VOLTAGE DROP
- BASE CURRENT REQUIREMENTS

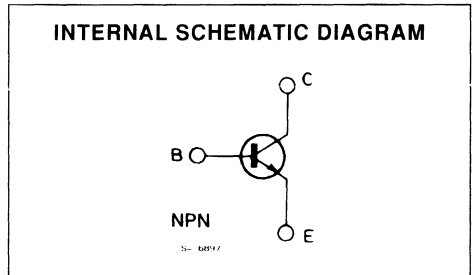
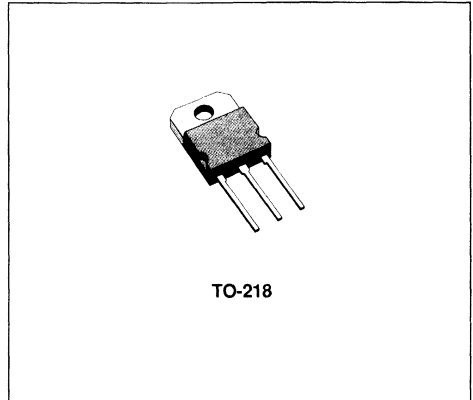

ABSOLUTE MAXIMUM RATINGS

Symbol	Parameter	Value	Unit
V_{CEV}	Collector-emitter Voltage ($V_{BE} = -1.5V$)	250	V
V_{CEO}	Collector-emitter Voltage ($I_B = 0$)	125	V
V_{EBO}	Emitter-base Voltage ($I_C = 0$)	7	V
I_C	Collector Current	25	A
I_{CM}	Collector Peak Current	50	A
I_B	Base Current	6	A
I_{BM}	Base Peak Current	12	A
P_{base}	Reverse Bias Base Power Dissipation (B.E. junction in avalanche)	2	W
P_{tot}	Total Dissipation at $T_C < 25^\circ C$	150	W
T_{stg}	Storage Temperature	- 65 to + 175	$^\circ C$
T_J	Max. Operating Junction Temperature	175	$^\circ C$

THERMAL DATA

$R_{thj-case}$	Thermal Resistance Junction-case	max	1	°C/W
----------------	----------------------------------	-----	---	------

ELECTRICAL CHARACTERISTICS ($T_{case} = 25^{\circ}C$ unless otherwise specified)

Symbol	Parameter	Test Conditions	Min.	Typ.	Max.	Unit
I_{CER}	Collector Cutoff Current ($R_{BE} = 10\Omega$)	$V_{CE} = V_{CEV}$ $V_{CE} = V_{CEV}$ $T_C = 100^{\circ}C$			1 5	mA mA
I_{CEV}	Collector Cutoff Current	$V_{CE} = V_{CEV}$ $V_{BE} = -1.5V$ $V_{CE} = V_{CEV}$ $V_{BE} = -1.5V$ $T_C = 100^{\circ}C$			1 5	mA mA
I_{EBO}	Emitter Cutoff Current ($I_C = 0$)	$V_{EB} = 5V$			1	mA
$V_{CEO(sus)}^*$	Collector Emitter Sustaining Voltage	$I_C = 0.2A$ $L = 25mH$	125			V
V_{EBO}	Emitter-base Voltage ($I_C = 0$)	$I_E = 5A$	7			V
$V_{CE(sat)}^*$	Collector-emitter Saturation Voltage	$I_C = 10A$ $I_B = 0.5A$ $I_C = 20A$ $I_B = 2A$ $I_C = 10A$ $I_B = 0.5A$ $T_j = 100^{\circ}C$ $I_C = 20A$ $I_B = 2A$ $T_j = 100^{\circ}C$		0.4 0.6 0.5 0.75	0.8 0.9 0.9 1.5	V V V V
$V_{BE(sat)}^*$	Base-emitter Saturation Voltage	$I_C = 20A$ $I_B = 2A$ $I_C = 20A$ $I_B = 2A$ $T_j = 100^{\circ}C$		1.25 1.25	1.6 1.7	V V
di_c/dt	Rate of Rise of on State Collector Current	$V_{CC} = 100V$ $R_C = 0$ $I_{B1} = 3A$ $T_j = 25^{\circ}C$ $T_j = 100^{\circ}C$ See fig. 2	50 45	100 85		A/ μs A/ μs
$V_{CE(2\mu s)}$	Collector-emitter Dynamic Voltage	$V_{CC} = 100V$ $R_C = 5\Omega$ $I_{B1} = 2A$ $T_j = 25^{\circ}C$ $T_j = 100^{\circ}C$ See fig. 2		1.4 2.1	3 4	V V
$V_{CE(4\mu s)}$	Collector-emitter Dynamic Voltage	$V_{CC} = 100V$ $R_C = 5\Omega$ $I_{B1} = 2A$ $T_j = 25^{\circ}C$ $T_j = 100^{\circ}C$ See fig. 2		1.1 1.5	2 2.5	V V

ELECTRICAL CHARACTERISTICS (continued)

RESISTIVE LOAD

Symbol	Parameter	Test Conditions		Min.	Typ.	Max.	Unit
t_r	Rise Time	$V_{CC} = 100V$	$I_C = 24A$		0.33	0.6	μs
t_s	Storage Time	$V_{BB} = -5V$	$I_{B1} = 3A$		0.75	1.2	μs
t_f	Fall Time	$R_B = 0.83\Omega$	$t_p = 30\mu s$		0.15	0.3	μs

INDUCTIVE LOAD

Symbol	Parameter	Test Conditions		Min.	Typ.	Max.	Unit
t_s	Storage Time	$V_{CC} = 100V$	$I_C = 20A$ $I_B = 2A$		0.85	1.4	μs
t_f	Fall Time	$V_{BB} = -5V$	$V_{clamp} = 125V$		0.09	0.2	μs
t_t	Tail Time in Turn-on	$L_C = 0.25mH$	$R_B = 1.3\Omega$		0.04	0.05	μs
t_c	Crossover Time	see fig. 3			0.16	0.3	μs
t_s	Storage Time	$V_{CC} = 100V$	$I_C = 20A$ $I_B = 2A$		1.2	1.7	μs
t_f	Fall Time	$V_{BB} = 0$	$V_{clamp} = 125V$		0.17	0.3	μs
t_t	Tail Time in Turn-on	$L_C = 0.25mH$	$R_B = 1.3\Omega$		0.07	0.1	μs
t_c	Crossover Time	see fig. 3	$T_j = 100^\circ C$		0.3	0.5	μs
t_s	Storage Time	$V_{CC} = 100V$	$I_C = 20A$ $I_B = 2A$		2.1		μs
t_f	Fall Time	$V_{BB} = 0$	$V_{clamp} = 125V$		0.7		μs
t_t	Tail Time in Turn-on	$L_C = 0.25mH$	$R_B = 4.7\Omega$		0.28		μs
		see fig. 3					
t_s	Storage Time	$V_{CC} = 100V$	$I_C = 20A$ $I_B = 2A$		3.2		μs
t_f	Fall Time	$V_{BB} = 0$	$V_{clamp} = 125V$		1.2		μs
t_t	Tail Time in Turn-on	$L_C = 0.25mH$	$R_B = 4.7\Omega$		0.55		μs
		see fig. 3	$T_j = 100^\circ C$				

* Pulsed : Pulse duration = 300 μs , duty cycle = 2%.

Figure 1 : Switching Times Test Circuit (resistive load).

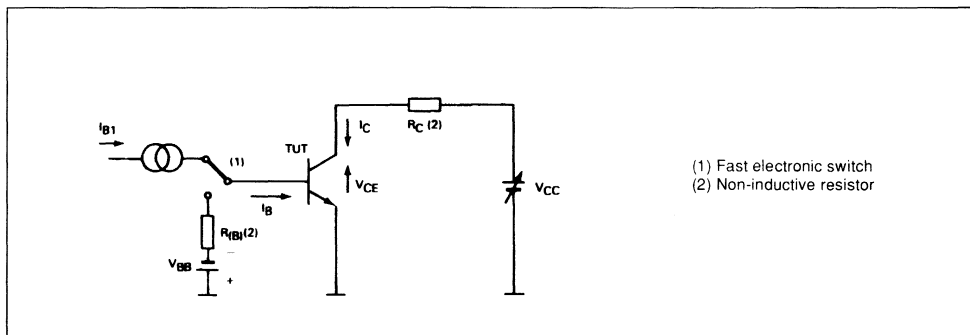

Figure 2 : Turn-on Switching Waveforms.

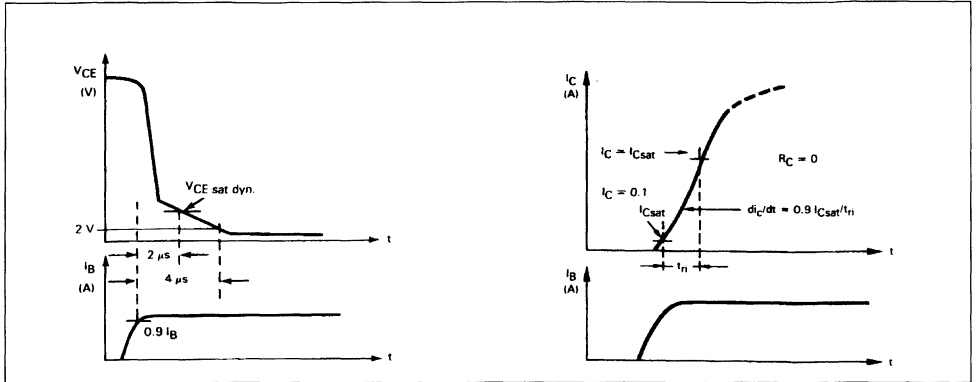

Figure 3a : Turn-off Switching Test Circuit.

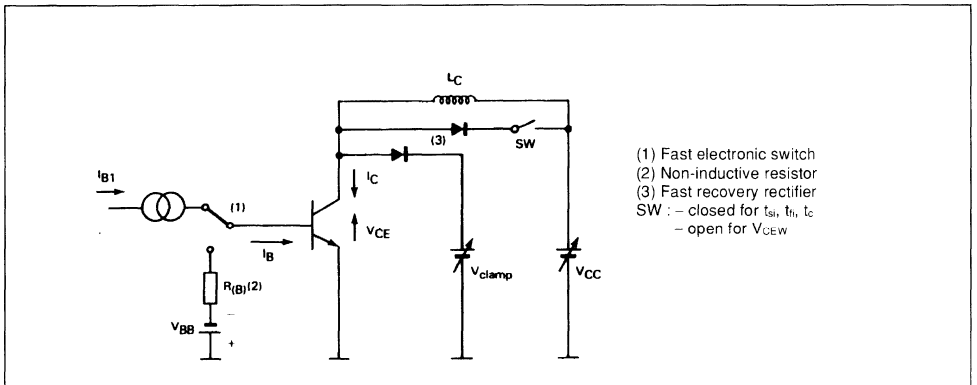
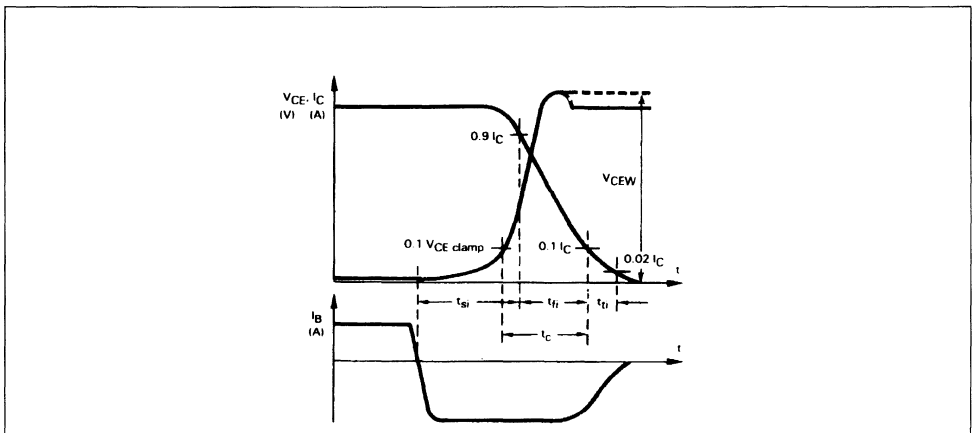
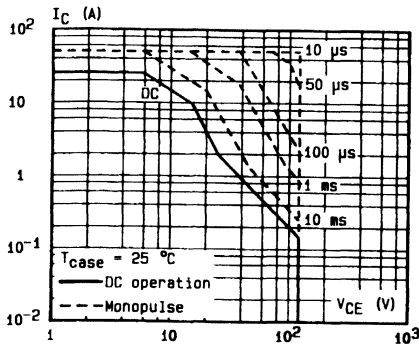

Figure 3b : Turn-off Switching Waveforms (inductive load).



DC and AC Pulse Area.



Power and $I_{S/B}$ Derating versus Case Temperature.

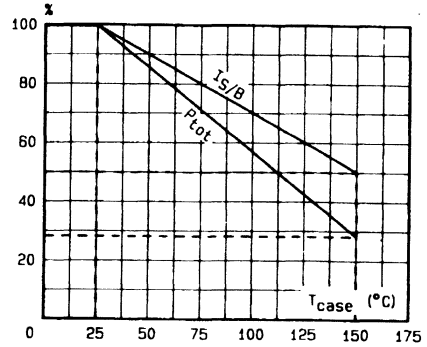

Transient Thermal Response.

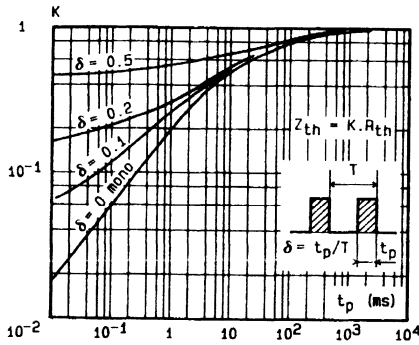

Collector-emitter Voltage versus Base-emitter Resistance.

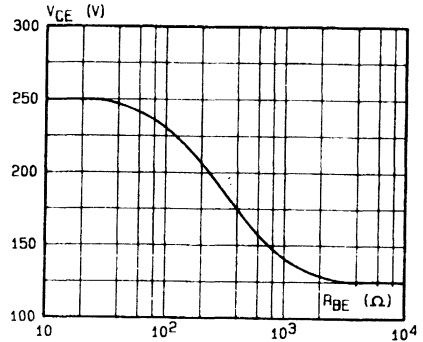

DC Current Gain.

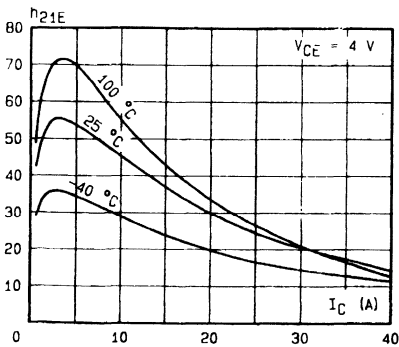

Minimum Base Current to Saturate the Transistor.

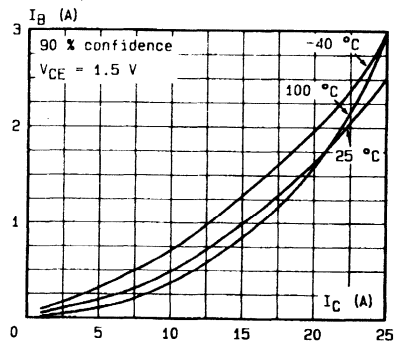

Saturation Voltage.

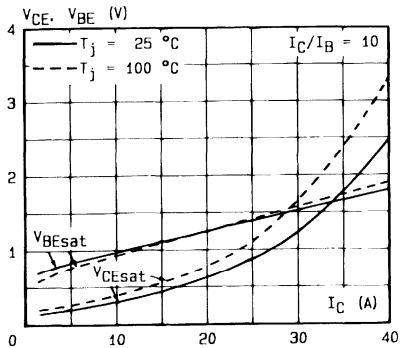

Saturation Voltage.

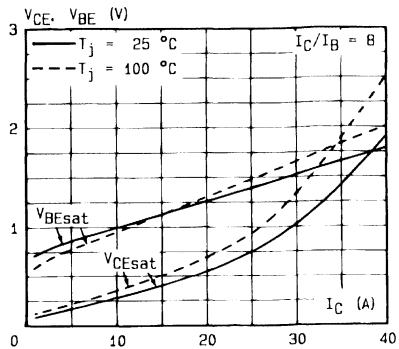

Switching Times versus Collector.

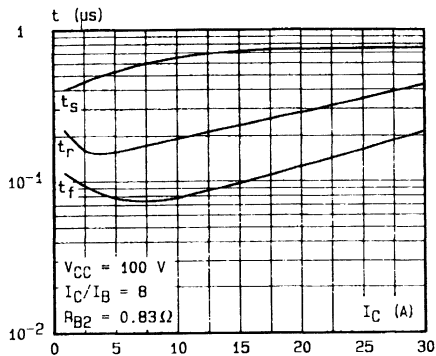

Switching Times versus Collector Current (inductive load).

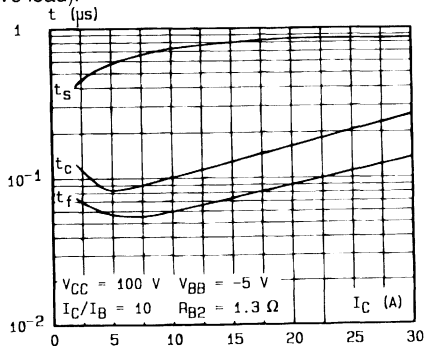

Switching Times versus Collector Current (inductive load).

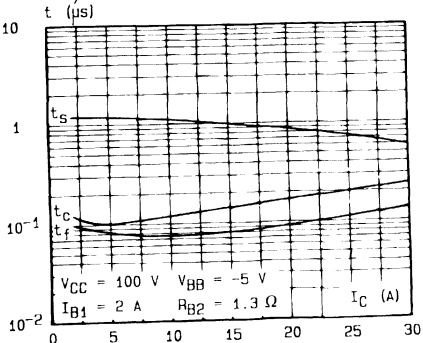

SWITCHING OPERATING AND OVERLOAD AREAS

TRANSISTOR FORWARD BIASED

- During the turn-on
- During the turn-off with negative base-emitter voltage and $4.7 \Omega \leq R_{BE} \leq 50 \Omega$.

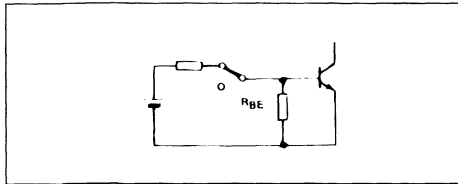

Forward Biased Safe Operating Area (FBSOA).

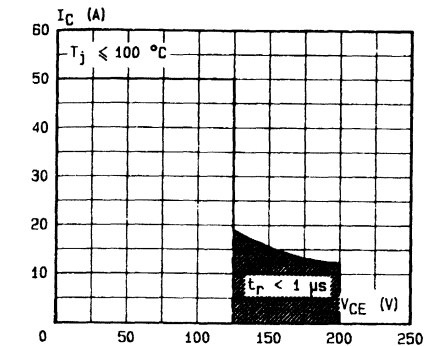

The hatched zone can only be used for turn-on.

Forward Biased Accidental Overload Area (FBADA).

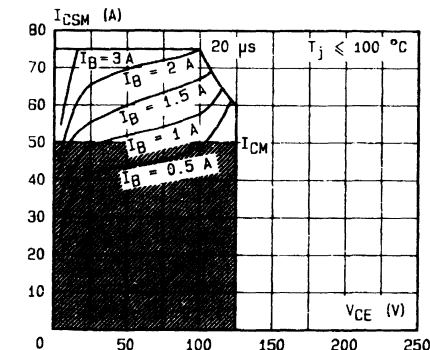

The Kellogg network (heavy point) allows the calculation of the maximum value of the short-circuit for a given base current I_B (90 % confidence).

High accidental surge currents ($I > I_{CM}$) are allowed if they are non repetitive and applied less than 3000 times during the component life.

TRANSISTOR REVERSE BIASED

- During the turn-off with negative base-emitter voltage.

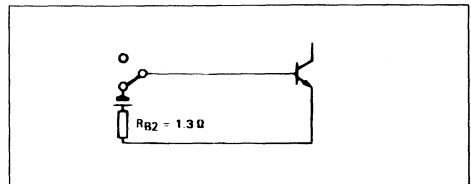

Reverse Biased Safe Operating Area (RBSOA).

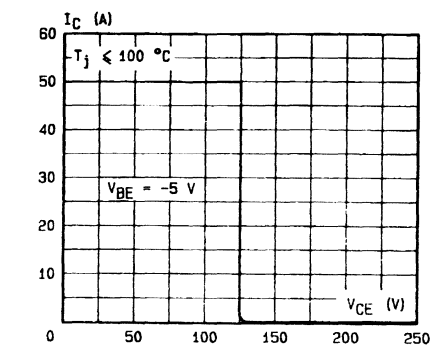

Reverse Biased Accidental Overload Area (RBADA).

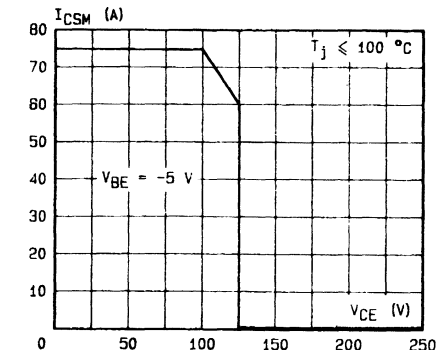

After the accidental overload current the RBAOA has to be used for the turn-off.

FAST SWITCHING POWER TRANSISTOR

- FAST SWITCHING TIMES
- LOW SWITCHING LOSSES
- VERY LOW SATURATION VOLTAGE AND HIGH GAIN

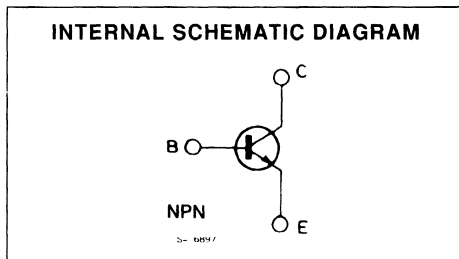
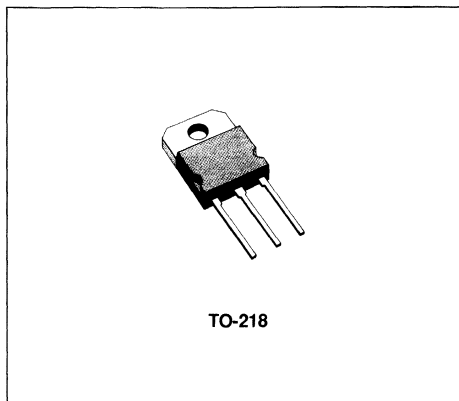
ABSOLUTE MAXIMUM RATINGS

Symbol	Parameter	Value	Unit
V_{CEV}	Collector-emitter Voltage ($V_{BE} = -1.5$ V)	300	V
V_{CEO}	Collector-emitter Voltage ($I_B = 0$)	200	V
V_{EBO}	Emitter-base Voltage ($I_C = 0$)	7	V
I_C	Collector Current	20	A
I_{CM}	Collector Peak Current	28	A
I_B	Base Current	4	A
I_{BM}	Base Peak Current	7	A
P_{base}	Reverse Bias Base Power Dissipation (B.E. junction in avalanche)	1	W
P_{tot}	Total Dissipation at $T_c < 25^\circ\text{C}$	150	W
T_{stg}	Storage Temperature	- 65 to 175	$^\circ\text{C}$
T_j	Max. Operating Junction Temperature	175	$^\circ\text{C}$

THERMAL DATA

$R_{th(j-case)}$	Thermal Resistance Junction-case	max	1	°C/W
------------------	----------------------------------	-----	---	------

ELECTRICAL CHARACTERISTICS ($T_{case} = 25^{\circ}C$ unless otherwise specified)

Symbol	Parameter	Test Conditions	Min.	Typ.	Max.	Unit
I_{CER}	Collector Cutoff Current ($R_{BE} = 10\Omega$)	$V_{CE} = V_{CEV}$ $V_{CE} = V_{CEV}$ $T_c = 100^{\circ}C$			0.5 2.5	mA mA
I_{CEV}	Collector Cutoff Current	$V_{CE} = V_{CEV}$ $V_{BE} = -1.5V$ $V_{CE} = V_{CEV}$ $V_{BE} = -1.5V$ $T_c = 100^{\circ}C$			0.5 2	mA mA
I_{EBO}	Emitter Cutoff Current ($I_C = 0$)	$V_{EB} = 5V$			1	mA
$V_{CEO(sus)^*}$	Collector Emitter Sustaining Voltage	$I_C = 0.2A$ $L = 25mH$	200			V
V_{EBO}	Emitter-base Voltage ($I_C = 0$)	$I_E = 50mA$	7			V
$V_{CE(sat)^*}$	Collector-emitter Saturation Voltage	$I_C = 5A$ $I_B = 0.25A$ $I_C = 10A$ $I_B = 1A$ $I_C = 5A$ $I_B = 0.25A$ $T_j = 100^{\circ}C$ $I_C = 10A$ $I_B = 1A$ $T_j = 100^{\circ}C$		0.4 0.45 0.4 0.6	0.8 0.9 0.9 1.5	V V V V
$V_{BE(sat)^*}$	Base-emitter Saturation Voltage	$I_C = 10A$ $I_B = 1A$ $I_C = 10A$ $I_B = 1A$ $T_j = 100^{\circ}C$		1.1 1	1.4 1.4	V V
di_C/dt	Rated of Rise of on-state Collector Current	$V_{CC} = 160V$ $R_C = 0$ See fig. 2				
			$I_{B1} = 1.5A$ $T_j = 25^{\circ}C$ $T_j = 100^{\circ}C$	35 30	75 65	A/ μs A/ μs
$V_{CE(2\mu s)}$	Collector Emitter Dynamic Voltage	$V_{CC} = 160V$ $R_C = 16\Omega$ See fig. 2				
			$I_{B1} = 1A$ $T_j = 25^{\circ}C$ $T_j = 100^{\circ}C$	1.8 3	3 5	V V
$V_{CE(4\mu s)}$	Collector Emitter Dynamic Voltage	$V_{CC} = 160V$ $R_C = 16\Omega$ See fig. 2				
			$I_{B1} = 1A$ $T_j = 25^{\circ}C$ $T_j = 100^{\circ}C$	1.1 1.4	1.7 2.5	V V

RESISTIVE LOAD

Symbol	Parameter	Test Conditions	Min.	Typ.	Max.	Unit
t_r	Rise Time	$V_{CC} = 160V$ $I_C = 14A$		0.3	0.6	μs
t_s	Storage Time	$V_{BB} = -5V$ $I_{B1} = 1.7A$		0.6	1.4	μs
t_f	Fall Time	$R_{B2} = 1.4\Omega$ $t_p = 30\mu s$ See fig. 1		0.12	0.3	μs

ELECTRICAL CHARACTERISTICS (continued)

INDUCTIVE LOAD

Symbol	Parameter	Test Conditions		Min.	Typ.	Max.	Unit
t_s	Storage Time	$V_{CC} = 160V$	$V_{clamp} = 200V$		0.7	1.5	μs
t_f	Fall Time	$I_C = 10A$	$I_B = 1A$		0.06	0.2	μs
t_t	Tail Time in Turn-on	$V_{BB} = -5V$	$R_{B2} = 2.5\Omega$		0.01	0.07	μs
t_c	Crossover Time	$L_C = 0.8mH$	See fig. 3		0.13	0.3	μs
t_s	Storage Time	$V_{CC} = 160V$	$V_{clamp} = 200V$		1.1	2	μs
t_f	Fall Time	$I_C = 10A$	$I_B = 1A$		0.12	0.3	μs
t_t	Tail Time in Turn-on	$V_{BB} = -5V$	$R_{B2} = 2.5\Omega$		0.03	0.15	μs
t_c	Crossover Time	$L_C = 0.8mH$	$T_j = 100^\circ C$		0.24	0.5	μs
t_s	Storage Time	$V_{CC} = 160V$	$V_{clamp} = 200V$		1.5		μs
t_f	Fall Time	$I_C = 10A$	$I_B = 1A$		0.5		μs
t_t	Tail Time in Turn-on	$V_{BB} = 0$	$R_{B2} = 4.7\Omega$		0.12		μs
		$L_C = 0.8mH$	See fig. 3				
t_s	Storage Time	$V_{CC} = 160V$	$V_{clamp} = 200V$		2.7		μs
t_f	Fall Time	$I_C = 10A$	$I_B = 1A$		0.85		μs
t_t	Tail Time in Turn-on	$V_{BB} = 0$	$R_{B2} = 4.7\Omega$		0.25		μs
		$L_C = 0.8mH$	$T_j = 100^\circ C$				
		See fig. 3					

* Pulsed : Pulse duration = 300 μs , duty cycle = 2 %.

Figure 1 : Switching Times Test Circuit (resistive load).

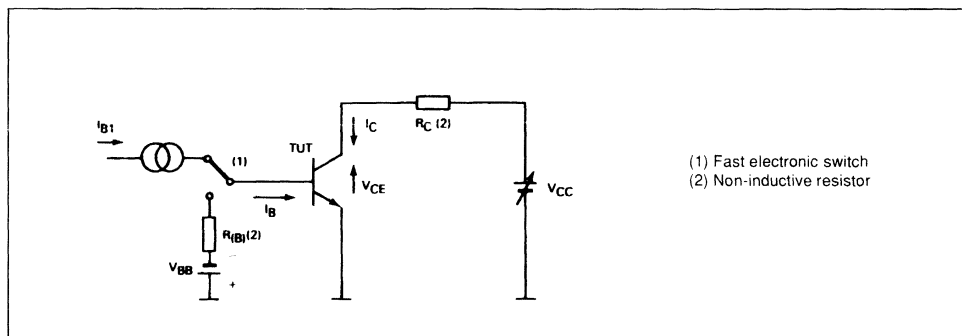

Figure 2 : Turn-on Switching Waveforms.

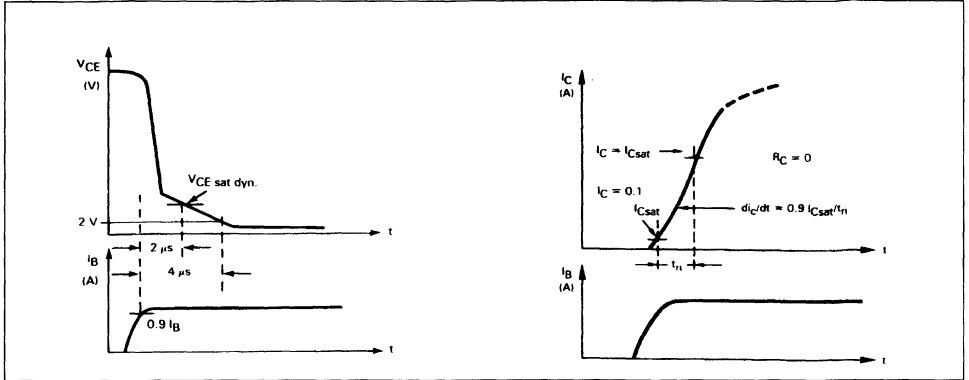

Figure 3a : Turn-off Switching Test Circuit.

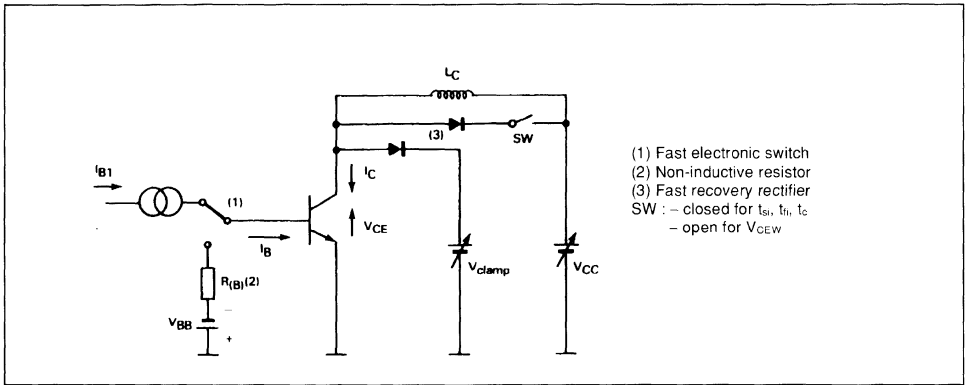
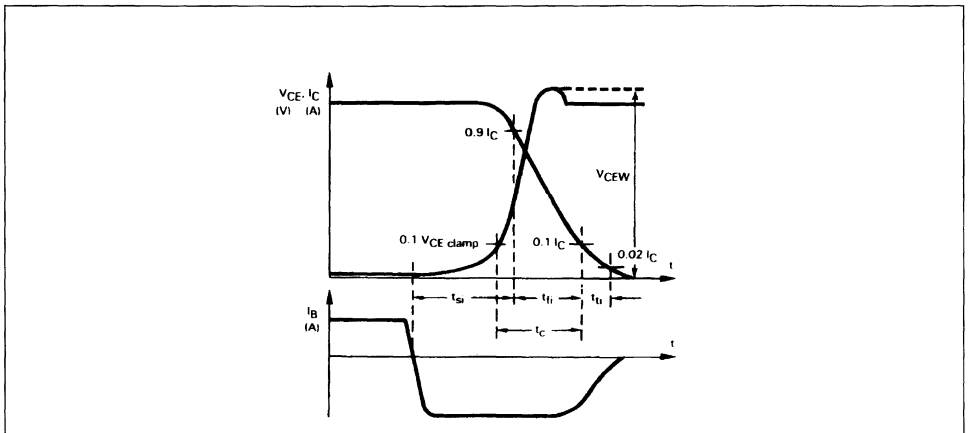
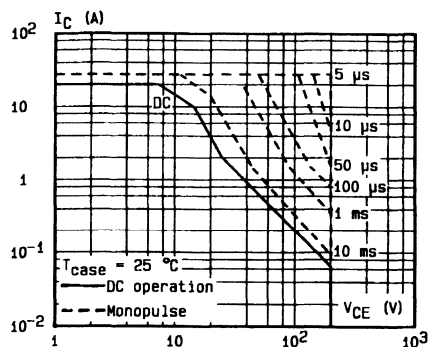

Figure 3b : Turn-off Switching Waveforms (inductive load).



DC and AC Pulse Area.



Power and $I_{S/B}$ Derating versus Case Temperature.

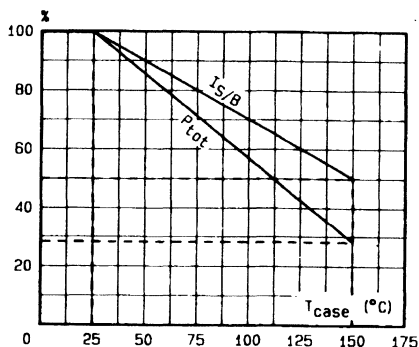

Transient Thermal Response.

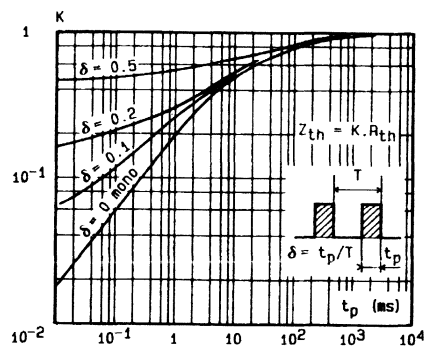

Collector-emitter Voltage versus Base-emitter Resistance.

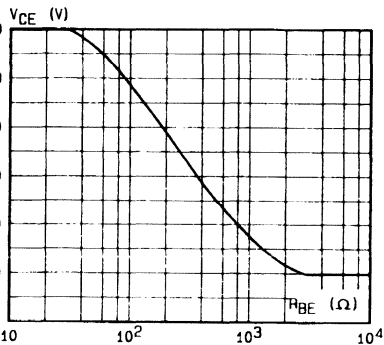

DC Current Gain.

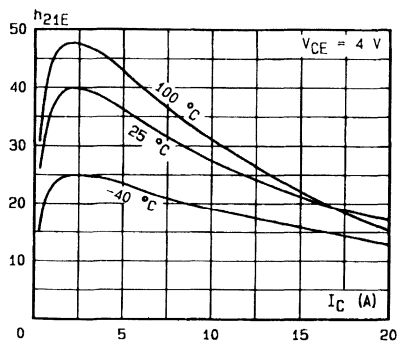

Minimum Base Current to Saturate the Transistor.

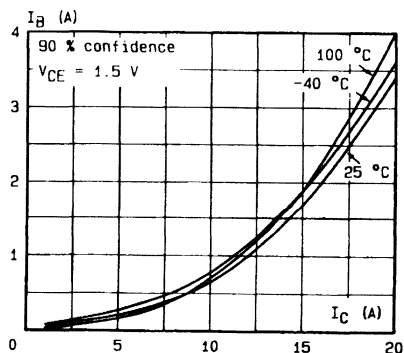

Saturation Voltage.

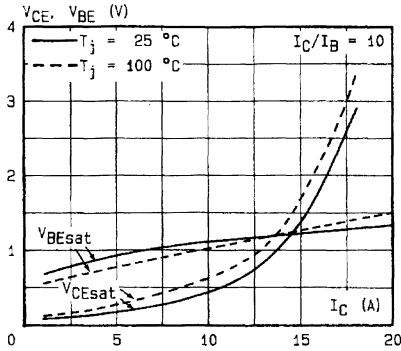

Saturation Voltage.

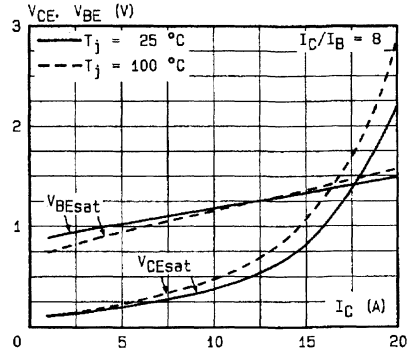

Switching Times versus Collector.

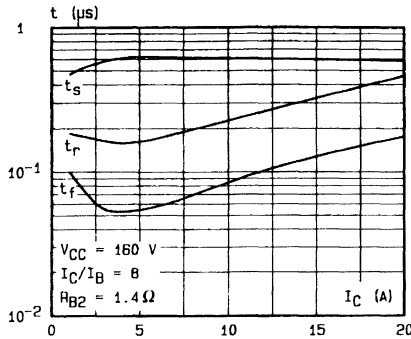

Switching Times versus Collector Current (inductive load).

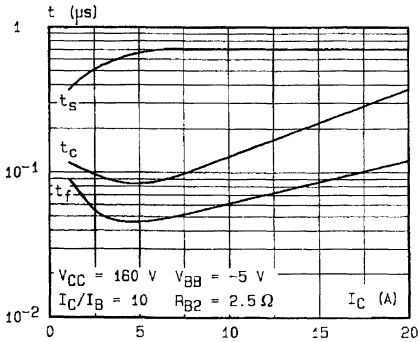

Switching Times versus Collector Current (inductive load).

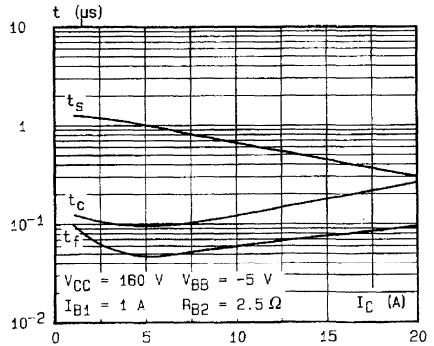

SWITCHING OPERATING AND OVERLOAD AREAS

TRANSISTOR FORWARD BIASED

- During the turn-on
- During the turn-off without negative base-emitter voltage and $4.7 \Omega \leq R_{BE} \leq 50 \Omega$.

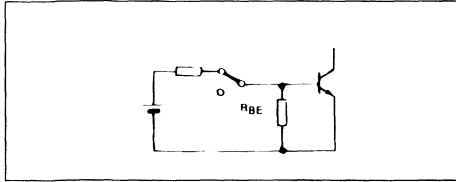

Forward Biased Safe Operating Area (FBSOA).

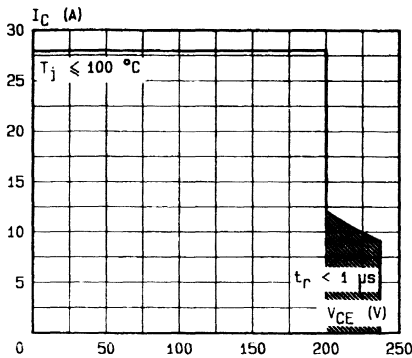

The hatched zone can only be used for turn-on.

Forward Biased Accidental Overload Area (FBAOA).

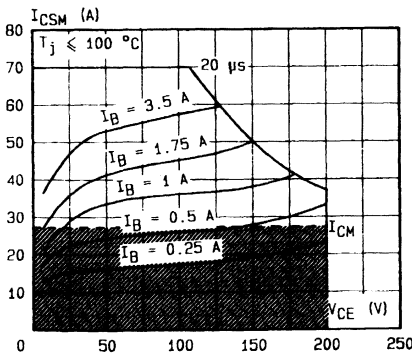

The Kellog network (heavy point) allows the calculation of the maximum value of the short-circuit for a given base current I_B (90 % confidence).

High accidental surge currents ($I > I_{CM}$) are allowed if they are non repetitive and applied less than 3000 times during the component life.

TRANSISTOR REVERSE BIASED

- During the turn-off with negative base-emitter voltage.

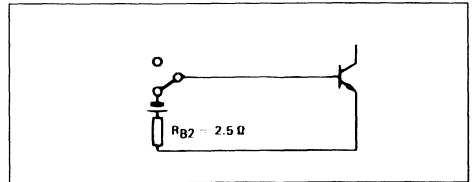

Reverse Biased Safe Operating Area (RBSOA).

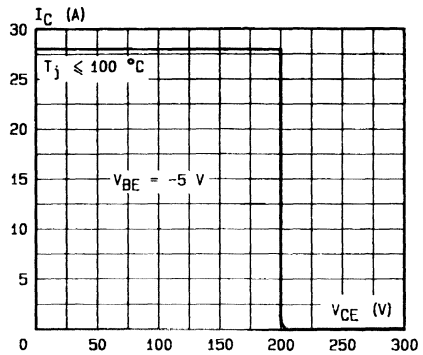

Reverse Biased Accidental Overload Area (RBAOA).

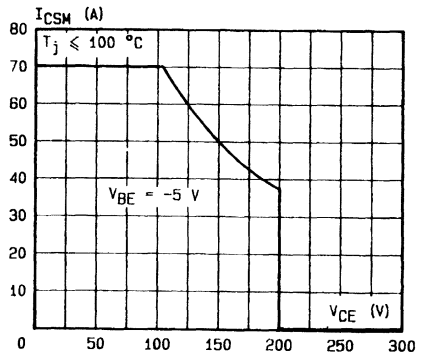

After the accidental overload current the RBAOA has to be used for the turn-off.

FAST SWITCHING POWER TRANSISTOR

- FAST SWITCHING TIMES
- LOW SWITCHING LOSSES
- VERY LOW SATURATION VOLTAGE AND HIGH GAIN

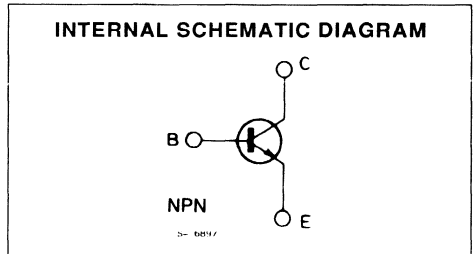
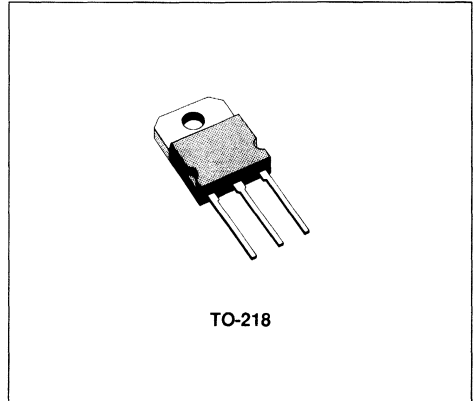

ABSOLUTE MAXIMUM RATINGS

Symbol	Parameter	Value	Unit
V_{CEV}	Collector-emitter Voltage ($V_{BE} = -1.5$ V)	350	V
V_{CEO}	Collector-emitter Voltage ($I_B = 0$)	250	V
V_{EBO}	Emitter-base Voltage ($I_C = 0$)	7	V
I_C	Collector Current	20	A
I_{CM}	Collector Peak Current	30	A
I_B	Base Current	4	A
I_{BM}	Base Peak Current	6	A
P_{base}	Reverse Bias Base Power Dissipation (B.E. junction in avalanche)	1	W
P_{tot}	Total Dissipation at $T_c < 25^\circ\text{C}$	150	W
T_{stg}	Storage Temperature	- 65 to 175	$^\circ\text{C}$
T_j	Max. Operating Junction Temperature	175	$^\circ\text{C}$

THERMAL DATA

$R_{th(j-case)}$	Thermal Resistance Junction-case	max	1	°C/W
------------------	----------------------------------	-----	---	------

ELECTRICAL CHARACTERISTICS ($T_{case} = 25^{\circ}C$ unless otherwise specified)

Symbol	Parameter	Test Conditions	Min.	Typ.	Max.	Unit	
I_{CER}	Collector Cutoff Current ($R_{BE} = 10\Omega$)	$V_{CE} = V_{CEV}$ $V_{CE} = V_{CEV}$ $T_C = 100^{\circ}C$			0.5 2.5	mA mA	
I_{CEV}	Collector Cutoff Current	$V_{CE} = V_{CEV}$ $V_{BE} = -1.5V$ $V_{CE} = V_{CEV}$ $V_{BE} = -1.5V$ $T_C = 100^{\circ}C$			0.5 2	mA mA	
I_{EBO}	Emitter Cutoff Current ($I_C = 0$)	$V_{EB} = 5V$			1	mA	
$V_{CE0(sus)^*}$	Collector Emitter Sustaining Voltage	$I_C = 0.2A$ $L = 25mH$	250			V	
V_{EBO}	Emitter-base Voltage ($I_C = 0$)	$I_E = 50mA$	7			V	
$V_{CE(sat)^*}$	Collector-emitter Saturation Voltage	$I_C = 4A$ $I_B = 0.26A$ $I_C = 8A$ $I_B = 0.8A$ $I_C = 4A$ $I_B = 0.26A$ $T_j = 100^{\circ}C$ $I_C = 8A$ $I_B = 0.8A$ $T_j = 100^{\circ}C$		0.35 0.45 0.35 0.6	0.8 0.9 0.9 1.5	V V V V	
$V_{BE(sat)^*}$	Base-emitter Saturation Voltage	$I_C = 8A$ $I_B = 0.8A$ $I_C = 8A$ $I_B = 0.8A$ $T_j = 100^{\circ}C$		1 0.9	1.3 1.3	V V	
di_C/dt	Rated of Rise of on-state Collector Current	$V_{CC} = 200V$ $R_C = 0$ See fig. 2		30 25	70 60	A/ μs A/ μs	
$V_{CE(2\mu s)}$	Collector Emitter Dynamic Voltage	$V_{CC} = 200V$ $R_C = 25\Omega$ See fig. 2			1.8 2.8	3 5	V V
$V_{CE(4\mu s)}$	Collector Emitter Dynamic Voltage	$V_{CC} = 200V$ $R_C = 25\Omega$ See fig. 2			1.1 1.5	1.7 2.5	V V

ELECTRICAL CHARACTERISTICS (continued)

RESISTIVE LOAD

Symbol	Parameter	Test Conditions		Min.	Typ.	Max.	Unit
t_r	Rise Time	$V_{CC} = 200V$	$I_C = 12A$	0.3	0.6		μs
t_s	Storage Time	$V_{BB} = -5V$	$I_{B1} = 1.5A$	1	1.6		μs
t_f	Fall Time	$R_{B2} = 1.7\Omega$	$t_p = 30\mu s$	0.15	0.3		μs
		See fig. 1					

INDUCTIVE LOAD

Symbol	Parameter	Test Conditions		Min.	Typ.	Max.	Unit
t_s	Storage Time	$V_{CC} = 200V$	$V_{clamp} = 250V$	1.2	1.8		μs
t_f	Fall Time	$I_C = 8A$	$I_B = 0.8A$	0.08	0.2		μs
t_t	Tail Time in Turn-on	$V_{BB} = -5V$	$R_{B2} = 3.1\Omega$	0.03	0.12		μs
t_c	Crossover Time	$L_C = 1.3mH$	See fig. 3	0.15	0.35		μs
t_s	Storage Time	$V_{CC} = 200V$	$V_{clamp} = 250V$	1.8	2.4		μs
t_f	Fall Time	$I_C = 8A$	$I_B = 0.8A$	0.2	0.4		μs
t_t	Tail Time in Turn-on	$V_{BB} = -5V$	$R_{B2} = 3.1\Omega$	0.08	0.2		μs
t_c	Crossover Time	$L_C = 1.3mH$	$T_j = 100^\circ C$	0.35	0.7		μs
t_s	Storage Time	$V_{CC} = 200V$	$V_{clamp} = 250V$	2.8			μs
t_f	Fall Time	$I_C = 8A$	$I_B = 0.8A$	0.5			μs
t_t	Tail Time in Turn-on	$V_{BB} = 0$	$R_{B2} = 5.6\Omega$	0.15			μs
		$L_C = 1.3mH$	See fig. 3				
t_s	Storage Time	$V_{CC} = 200V$	$V_{clamp} = 250V$	4.5			μs
t_f	Fall Time	$I_C = 8A$	$I_B = 0.8A$	0.8			μs
t_t	Tail Time in Turn-on	$V_{BB} = 0$	$R_{B2} = 5.6\Omega$	0.4			μs
		$L_C = 1.3mH$	$T_j = 100^\circ C$				
		See fig. 3					

* Pulsed : Pulse duration = 300 ms, duty cycle = 2 %.

Figure 1 : Switching Times Test Circuit (resistive load).

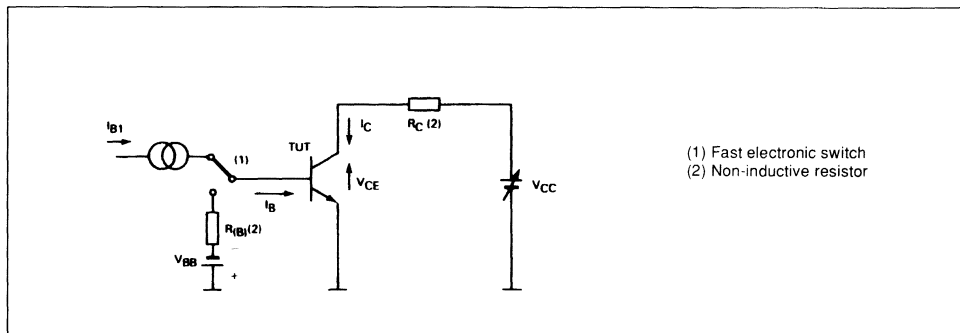

Figure 2 : Turn-on Switching Waveforms.

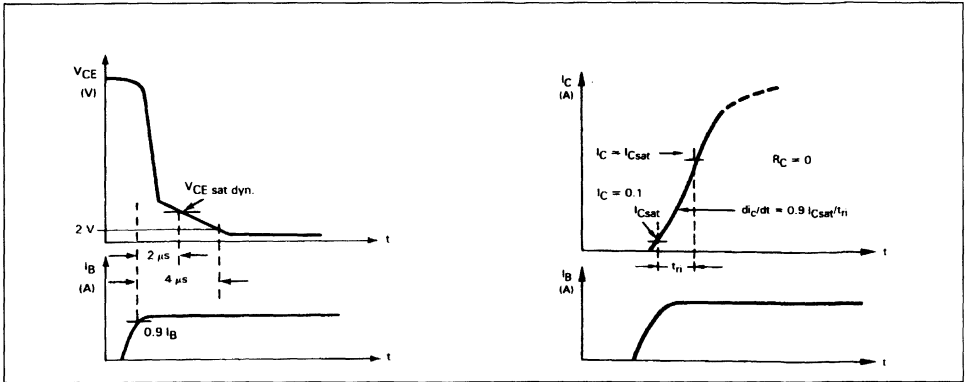

Figure 3a : Turn-off Switching Test Circuit.

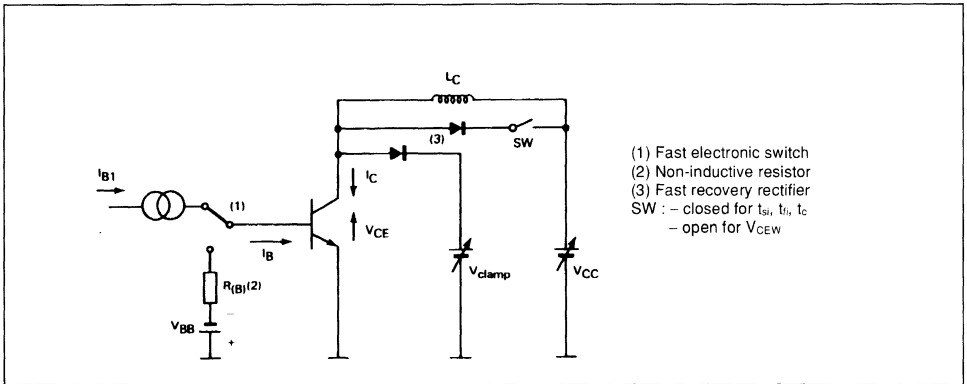
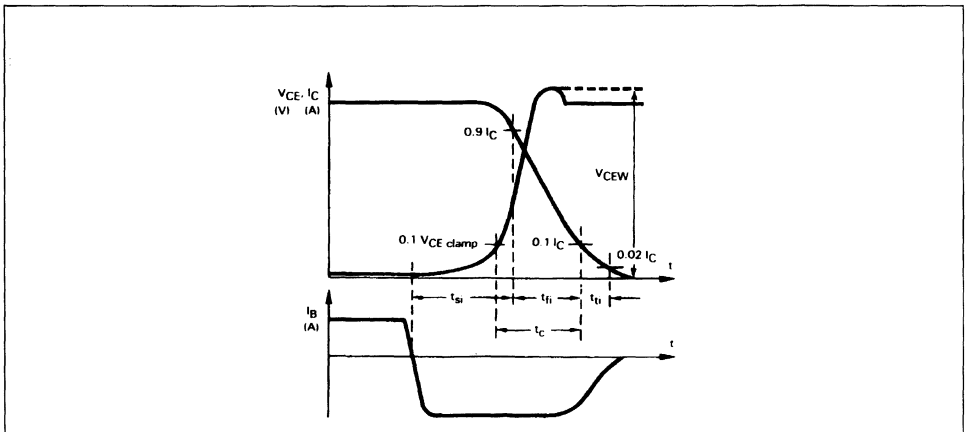
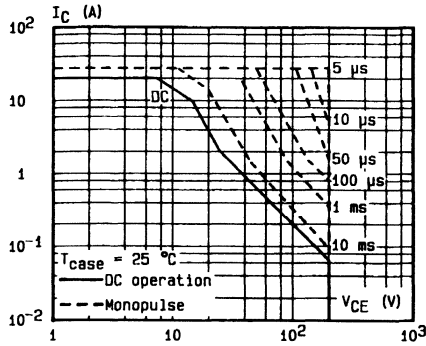

Figure 3b : Turn-off Switching Waveforms (inductive load).



DC and AC Pulse Area.



Power and $I_{S/B}$ Derating versus Case Temperature.

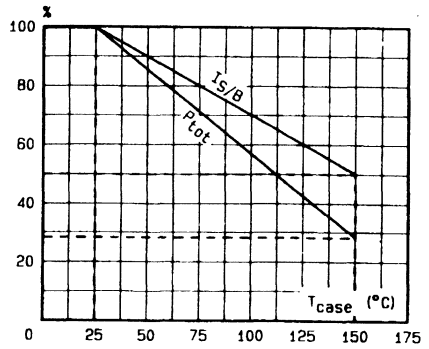

Transient Thermal Response.

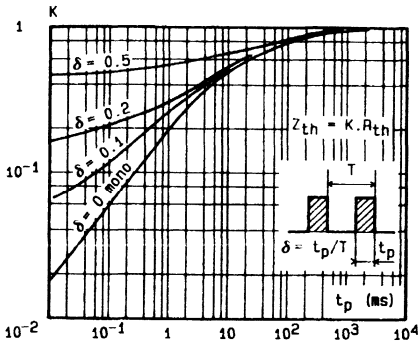

Collector-emitter Voltage versus Base-emitter Resistance.

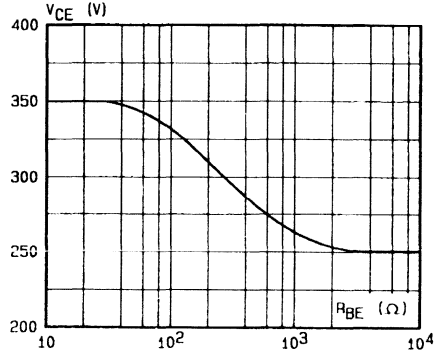

DC Current Gain.

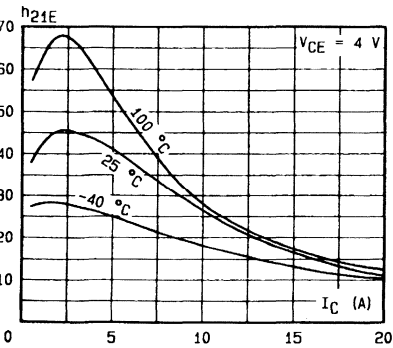

Minimum Base Current to Saturate the Transistor.

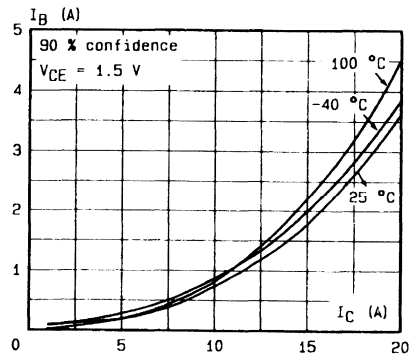

Saturation Voltage.

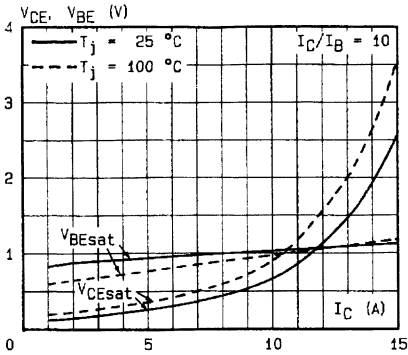

Saturation Voltage.

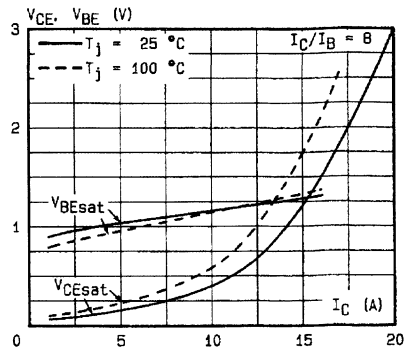

Switching Times versus Collector.

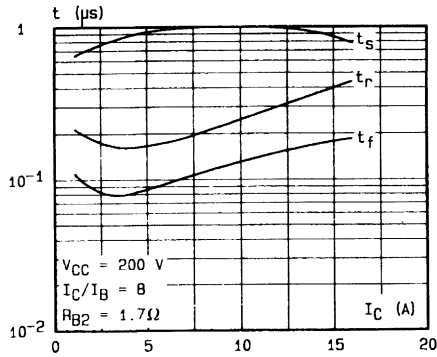

Switching Times versus Collector Current (inductive load).

Switching Times versus Collector Current (inductive load).

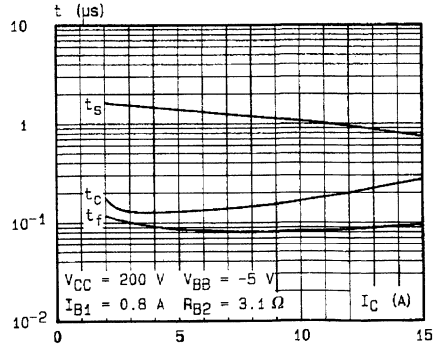
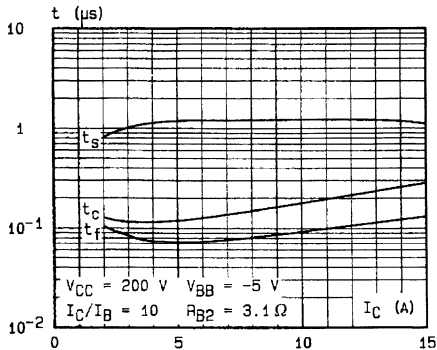

SWITCHING OPERATING AND OVERLOAD AREAS

TRANSISTOR FORWARD BIASED

- During the turn-on
- During the turn-off without negative base-emitter voltage and $5.6 \Omega \leq R_{BE} \leq 50 \Omega$.

TRANSISTOR REVERSE BIASED

- During the turn-off with negative base-emitter voltage.

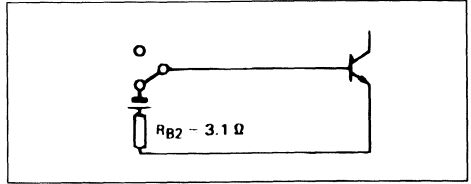
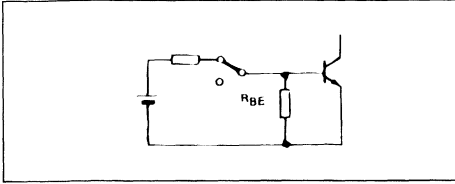

Forward Biased Safe Operating Area (FBSOA).

Reverse Biased Safe Operating Area (RBSOA).

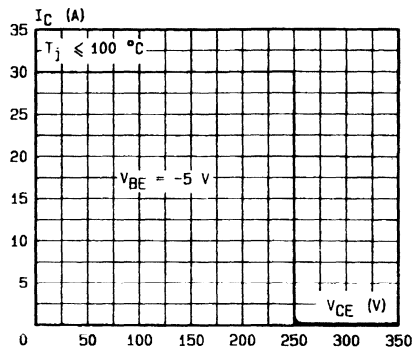
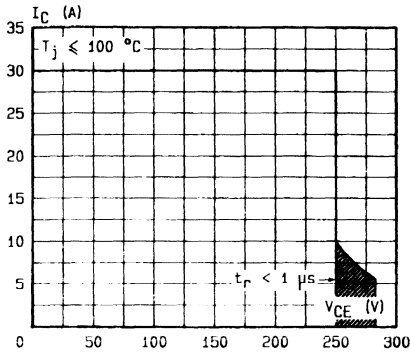

The hatched zone can only be used for turn-on.

Forward Biased Accidental Overload Area (FBADA).

Reverse Biased Accidental Overload Area (RBADA).

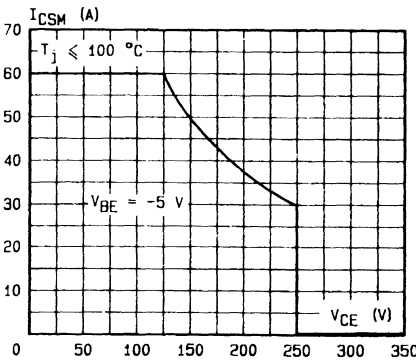
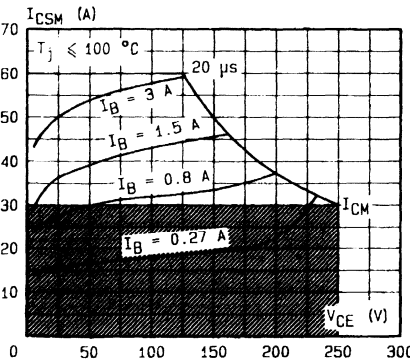

The Kellogg network (heavy point) allows the calculation of the maximum value of the short-circuit for a given base current I_B (90 % confidence).

After the accidental overload current the RBAOA has to be used for the turn-off.

High accidental surge currents ($I > I_{CM}$) are allowed if they are non repetitive and applied less than 3000 times during the component life.

FAST SWITCHING POWER TRANSISTOR

- FAST SWITCHING TIMES
- LOW SWITCHING LOSSES
- VERY LOW SATURATION VOLTAGE AND HIGH GAIN

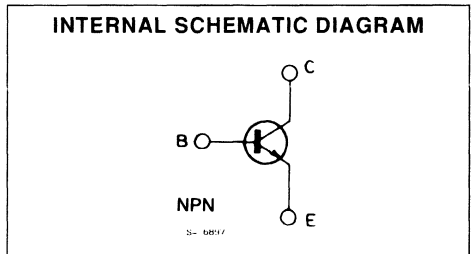
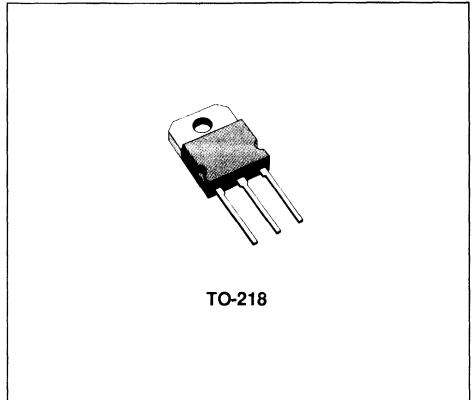
ABSOLUTE MAXIMUM RATINGS

Symbol	Parameter	Value	Unit
V_{CEV}	Collector-emitter Voltage ($V_{BE} = -1.5V$)	160	V
V_{CEO}	Collector-emitter Voltage ($I_B = 0$)	90	V
V_{EBO}	Emitter-base Voltage ($I_C = 0$)	7	V
I_C	Collector Current	25	A
I_{CM}	Collector Peak Current	45	A
I_B	Base Current	6	A
I_{BM}	Base Peak Current	9	A
P_{base}	Reverse Bias Base Power Dissipation (B.E. junction in avalanche)	1	W
P_{tot}	Total Dissipation at $T_c < 25^\circ C$	125	W
T_{stg}	Storage Temperature	- 65 to 175	$^\circ C$
T_j	Max. Operating Junction Temperature	175	$^\circ C$

THERMAL DATA

$R_{thj-case}$	Thermal Resistance Junction-case	max	1	°C/W
----------------	----------------------------------	-----	---	------

ELECTRICAL CHARACTERISTICS ($T_{case} = 25^{\circ}C$ unless otherwise specified)

Symbol	Parameter	Test Conditions	Min.	Typ.	Max.	Unit
I_{CER}	Collector Cutoff Current ($R_{BE} = 10\Omega$)	$V_{CE} = V_{CEV}$ $V_{CE} = V_{CEV}$ $T_c = 100^{\circ}C$			1 5	mA mA
I_{CEV}	Collector Cutoff Current	$V_{CE} = V_{CEV}$ $V_{BE} = -1.5V$ $V_{CE} = V_{CEV}$ $V_{BE} = -1.5V$ $T_c = 100^{\circ}C$			1 5	mA mA
I_{EBO}	Emitter Cutoff Current ($I_C = 0$)	$V_{EB} = 5V$			1	mA
$V_{CEO(sus)}^*$	Collector Emitter Sustaining Voltage	$I_C = 0.2A$ $L = 25mH$	90			V
V_{EBO}	Emitter-base Voltage ($I_C = 0$)	$I_E = 50mA$	7			V
$V_{CE(sat)}^*$	Collector-emitter Saturation Voltage	$I_C = 7.5A$ $I_B = 0.375A$ $I_C = 15A$ $I_B = 1.5A$ $I_C = 7.5A$ $I_B = 0.375A$ $T_j = 100^{\circ}C$ $I_C = 15A$ $I_B = 1.5A$ $T_j = 100^{\circ}C$		0.5 0.65 0.5 0.8	0.8 0.9 0.9 1.5	V V V V
$V_{BE(sat)}^*$	Base-emitter Saturation Voltage	$I_C = 15A$ $I_B = 1.5A$ $I_C = 15A$ $I_B = 1.5A$ $T_j = 100^{\circ}C$		1.4 1.45	1.7 1.8	V V
di_C/dt	Rated of Rise of on-state Collector Current	$V_{CC} = 72V$ $R_C = 0$ $I_{B1} = 2.25A$ See fig. 2 $T_j = 25^{\circ}C$ $T_j = 100^{\circ}C$	35 30	50 45		A/ μs A/ μs
$V_{CE(2\mu s)}$	Collector Emitter Dynamic Voltage	$V_{CC} = 72V$ $R_C = 4.8\Omega$ $I_{B1} = 1.5A$ See fig. 2 $T_j = 25^{\circ}C$ $T_j = 100^{\circ}C$		1.7 2	2.5 4	V V
$V_{CE(4\mu s)}$	Collector Emitter Dynamic Voltage	$V_{CC} = 72V$ $R_C = 4.8\Omega$ $I_{B1} = 1.5A$ See fig. 2 $T_j = 25^{\circ}C$ $T_j = 100^{\circ}C$		1 1.5	2 3	V V

RESISTIVE LOAD

Symbol	Parameter	Test Conditions	Min.	Typ.	Max.	Unit
t_r	Rise Time	$V_{CC} = 72V$ $I_C = 20A$		0.55	1.1	μs
t_s	Storage Time	$V_{BB} = -5V$ $I_{B1} = 2.5A$		0.55	1	μs
t_f	Fall Time	$R_{B2} = 1\Omega$ $t_p = 30\mu s$ See fig. 1		0.12	0.25	μs

ELECTRICAL CHARACTERISTICS (continued)

INDUCTIVE LOAD

Symbol	Parameter	Test Conditions		Min.	Typ.	Max.	Unit
t_s	Storage Time	$V_{CC} = 72V$	$V_{clamp} = 90V$		0.75	1.2	μs
t_f	Fall Time	$I_C = 15A$	$I_B = 1.5A$		0.09	0.2	μs
t_t	Tail Time in Turn-on	$V_{BB} = -5V$	$R_{B2} = 1.7\Omega$		0.03	0.05	μs
t_c	Crossover Time	$L_C = 0.25mH$	See fig. 3		0.14	0.3	μs
t_s	Storage Time	$V_{CC} = 72V$	$V_{clamp} = 90V$		0.95	1.7	μs
t_f	Fall Time	$I_C = 15A$	$I_B = 1.5A$		0.15	0.3	μs
t_t	Tail Time in Turn-on	$V_{BB} = -5V$	$R_{B2} = 1.7\Omega$		0.06	0.1	μs
t_c	Crossover Time	$L_C = 0.25mH$	$T_j = 100^\circ C$		0.3	0.5	μs
t_s	Storage Time	$V_{CC} = 72V$	$V_{clamp} = 90V$		1.4		μs
t_f	Fall Time	$I_C = 15A$	$I_B = 1.5A$		0.7		μs
t_t	Tail Time in Turn-on	$V_{BB} = 0$	$R_{B2} = 3.9\Omega$		0.22		μs
		$L_C = 0.25mH$	See fig. 3				
t_s	Storage Time	$V_{CC} = 72V$	$V_{clamp} = 90V$		1.85		μs
t_f	Fall Time	$I_C = 15A$	$I_B = 1.5A$		1		μs
t_t	Tail Time in Turn-on	$V_{BB} = 0$	$R_{B2} = 3.9\Omega$		0.44		μs
		$L_C = 0.25mH$	$T_j = 100^\circ C$				
		See fig. 3					

* Pulsed test $t_p < 300 \mu s$ $\delta < 2 \%$.

Figure 1 : Switching Times Test Circuit (resistive load).

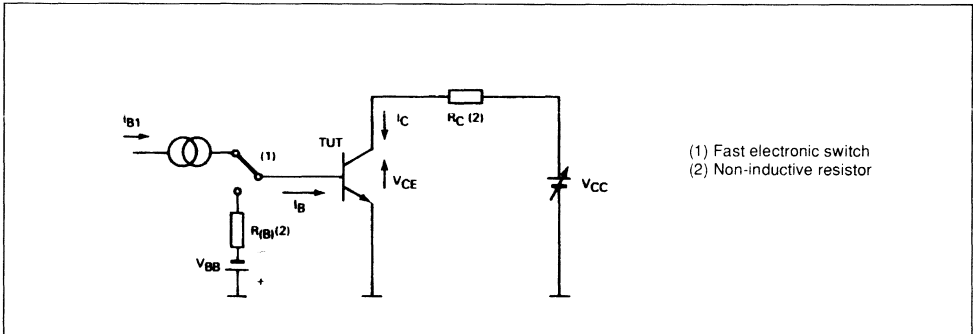

Figure 2 : Turn-on Switching Waveforms.

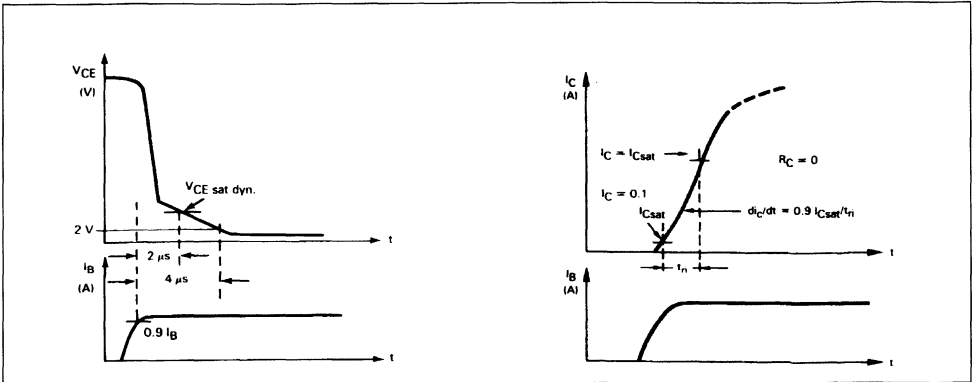

Figure 3a : Turn-off Switching Test Circuit.

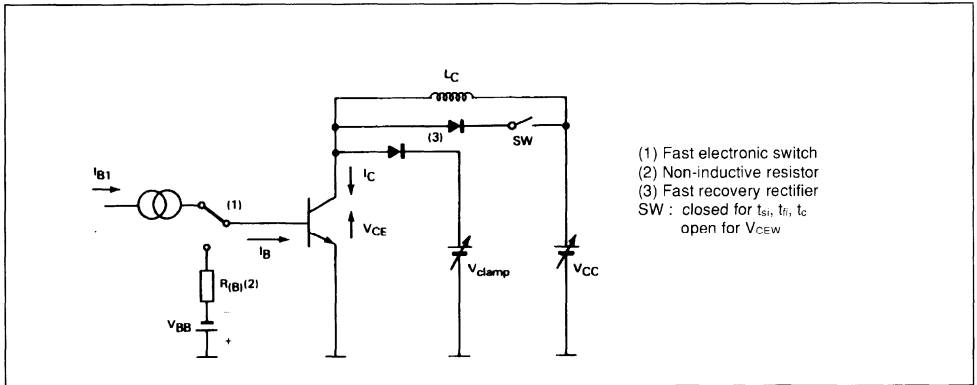
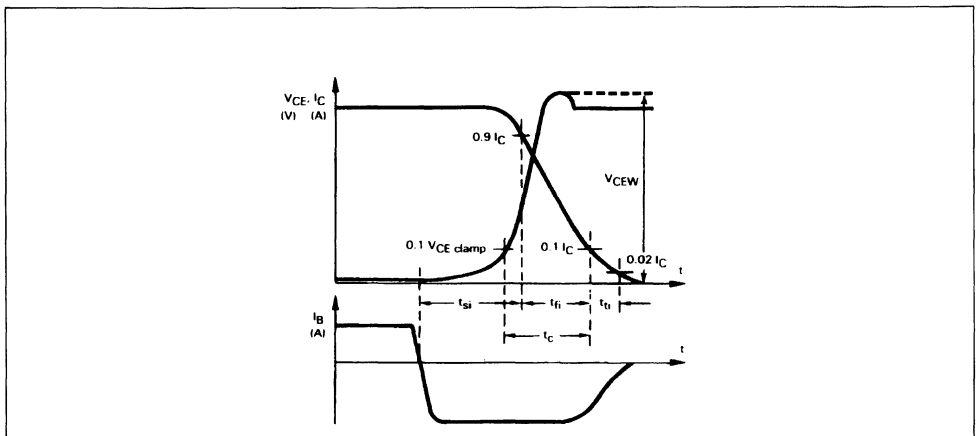
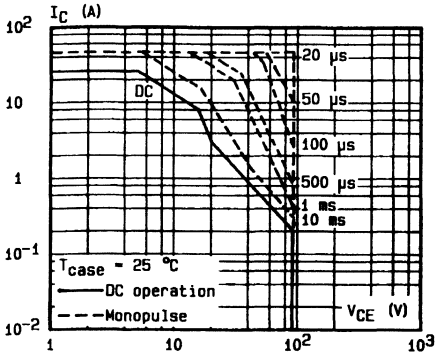

Figure 3b : Turn-off Switching Waveforms (inductive load).



DC and AC Pulse Area.



Power and $I_{S/B}$ Derating versus Case Temperature.

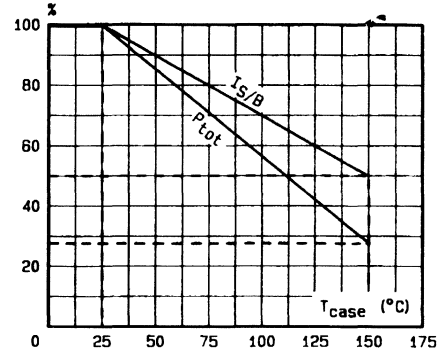

Transient Thermal Response.

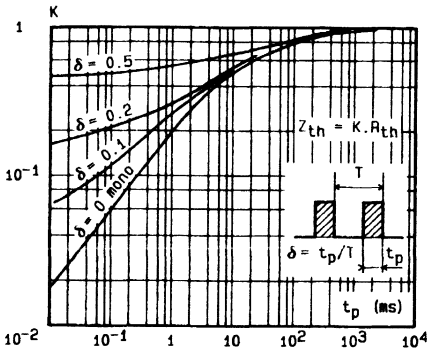

Collector-emitter Voltage versus Base-emitter Resistance.

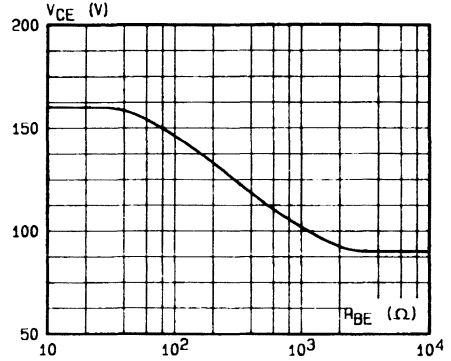

DC Current Gain.

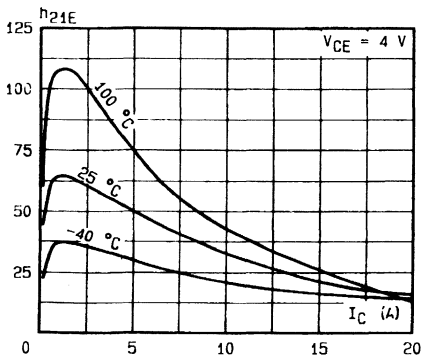

Minimum Base Current to Saturate the Transistor.

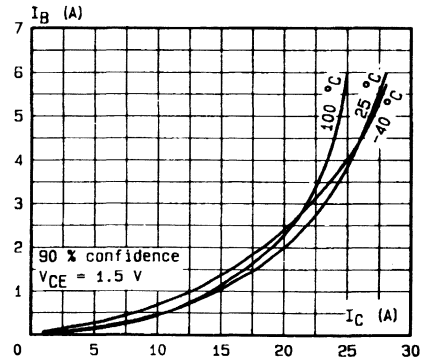

Saturation Voltage.

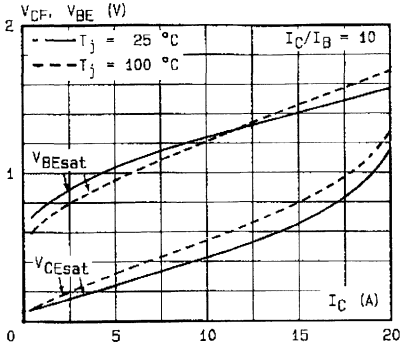

Saturation Voltage.

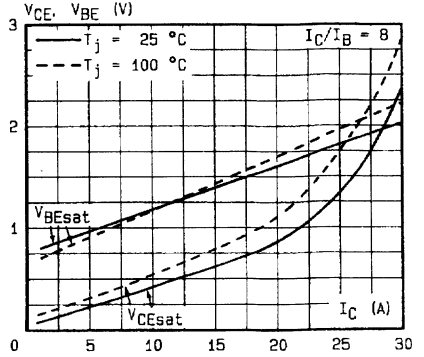

Switching Times Versus Collector

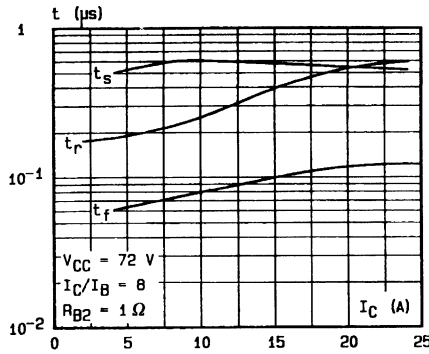

Switching Times versus Collector Current (inductive load).

Switching Times versus Collector Current (inductive load).

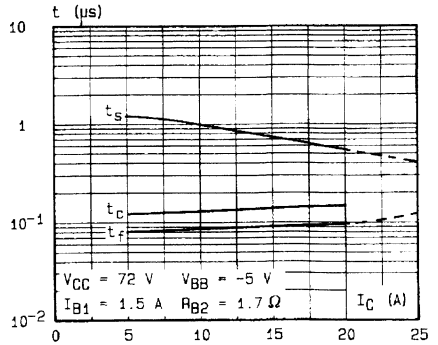
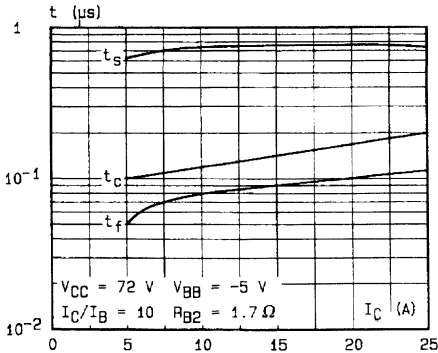

SWITCHING OPERATING AND OVERLOAD AREAS

TRANSISTOR FORWARD BIASED

- During the turn-on
- During the turn-off without negative base-emitter voltage and $3.9 \Omega \leq R_{BE} \leq 50 \Omega$.

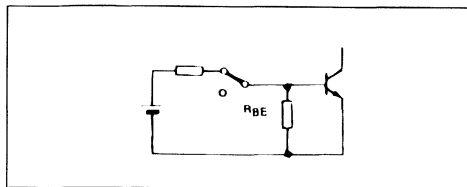

Forward Biased Safe Operating Area (FBSOA).

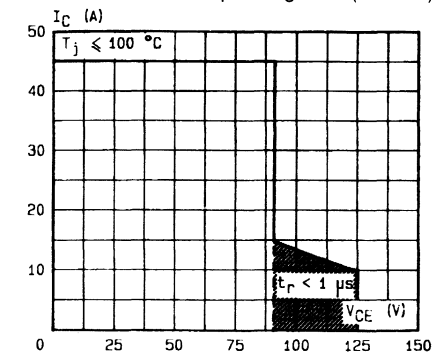

The hatched zone can only be used for turn-on.

Forward Biased Accidental Overload Area (FBAOA).

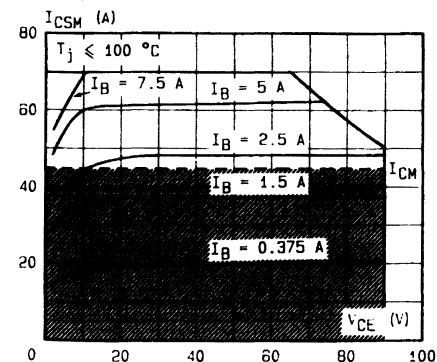

The Kellog network (heavy point) allows the calculation of the maximum value of the short-circuit for a given base current I_B (90 % confidence).

High accidental surge currents ($I > I_{CM}$) are allowed if they are non repetitive and applied less than 3000 times during the component life.

TRANSISTOR REVERSE BIASED

- During the turn-off with negative base-emitter voltage.

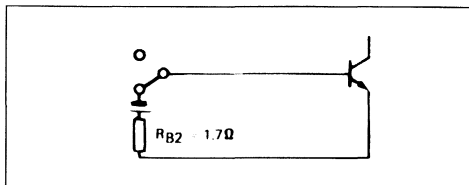

Reverse Biased Safe Operating Area (RBSOA).

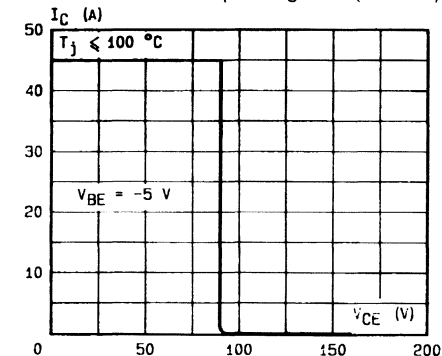

Reverse Biased Accidental Overload Area (RBAOA).

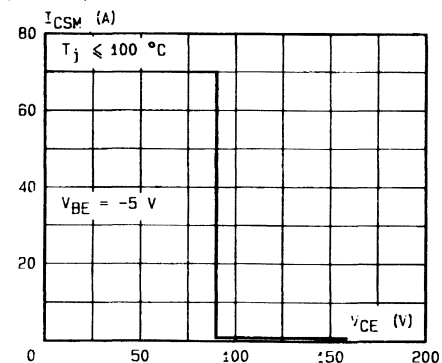

After the accidental overload current the RBAOA has to be used for the turn-off.

NPN FAST SWITCHING POWER TRANSISTOR

- VERY LOW SATURATION VOLTAGE AND HIGH GAIN FOR REDUCED LOAD OPERATION
- TURN-ON AND TURN-OFF TAIL SPECIFICATIONS
- TURN-ON di/dt FOR BETTER RECTIFIER CHOICE
- SWITCHING TIMES SPECIFIED WITH AND WITHOUT NEGATIVE BASE DRIVE
- FAST SWITCHING TIMES
- LOW SWITCHING LOSSES
- LOW ON-STATE VOLTAGE DROP
- BASE CURRENT REQUIREMENTS

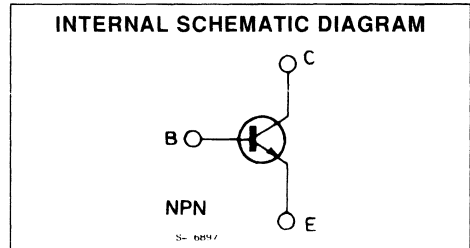
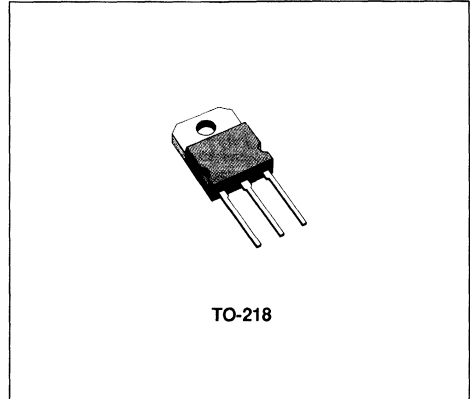

ABSOLUTE MAXIMUM RATINGS

Symbol	Parameter	Value	Unit
V_{CEV}	Collector-emitter Voltage ($V_{BE} = -1.5$ V)	250	V
V_{CEO}	Collector-emitter Voltage ($I_B = 0$)	125	V
V_{EBO}	Emitter-base Voltage ($I_C = 0$)	7	V
I_C	Collector Current	20	A
I_{CM}	Collector Peak Current	30	A
I_B	Base Current	4	A
I_{BM}	Base Peak Current	6	A
P_{base}	Reverse Bias Base Power Dissipation (B.E. junction in avalanche)	1	W
P_{tot}	Total Dissipation at $T_c < 25$ °C	125	W
T_{stg}	Storage Temperature	- 65 to 175	°C
T_j	Max. Operating Junction Temperature	175	°C

THERMAL DATA

$R_{thj-case}$	Thermal Resistance Junction-case	Max	1.2	°C/W
----------------	----------------------------------	-----	-----	------

ELECTRICAL CHARACTERISTICS ($T_{case} = 25\text{ °C}$ unless otherwise specified)

Symbol	Parameter	Test Conditions	Min.	Typ.	Max.	Unit
I_{CER}	Collector Cutoff Current ($R_{BE} = 10\ \Omega$)	$V_{CE} = V_{CEV}$ $V_{CE} = V_{CEV}$ $T_c = 100\text{ °C}$			1 5	mA mA
I_{CEV}	Collector Cutoff Current	$V_{CE} = V_{CEV}$ $V_{BE} = -1.5\text{ V}$ $V_{CE} = V_{CEV}$ $V_{BE} = -1.5\text{ V}$ $T_c = 100\text{ °C}$			1 5	mA mA
I_{EBO}	Emitter Cutoff Current ($I_C = 0$)	$V_{EB} = 5\text{ V}$			1	mA
$V_{CEO(sus)*}$	Collector Emitter Sustaining Voltage	$I_C = 0.2\text{ A}$ $L = 25\text{ mH}$	125			V
V_{EBO}	Emitter-base Voltage ($I_C = 0$)	$I_E = 50\text{ mA}$	7			V
$V_{CE(sat)*}$	Collector-emitter Saturation Voltage	$I_C = 5.5\text{ A}$ $I_B = 0.35\text{ A}$ $I_C = 11\text{ A}$ $I_B = 1.1\text{ A}$ $I_C = 5.5\text{ A}$ $I_B = 0.35\text{ A}$ $T_j = 100\text{ °C}$ $I_C = 11\text{ A}$ $I_B = 1.1\text{ A}$ $T_j = 100\text{ °C}$		0.5 0.65 0.5 0.8	0.8 0.9 0.9 1.2	V V V V
$V_{BE(sat)*}$	Base-emitter Saturation Voltage	$I_C = 11\text{ A}$ $I_B = 1.1\text{ A}$ $I_C = 11\text{ A}$ $I_B = 1.1\text{ A}$ $T_j = 100\text{ °C}$		1.3 1.35	1.6 1.7	V V
di_c/dt	Rate of Rise of on State Collector Current	$V_{CC} = 100\text{ V}$ $R_C = 0$ See fig. 2		35 30	45 40	A/ μ s A/ μ s
$V_{CE(2\mu s)}$	Collector-emitter Dynamic Voltage	$V_{CC} = 100\text{ V}$ $R_C = 9\ \Omega$ See fig. 2		2 2.6	2.5 4	V V
$V_{CE(4\mu s)}$	Collector-emitter Dynamic Voltage	$V_{CC} = 100\text{ V}$ $R_C = 9\ \Omega$ See fig. 2		1.1 1.6	2 2.5	V V

ELECTRICAL CHARACTERISTICS (continued)

Symbol	Parameter	Test Conditions	Min.	Typ.	Max.	Unit
t_r t_s t_f t_t	RESISTIVE LOAD					μs
	Rise Time	$V_{CC} = 100\text{ V}$ $I_C = 15\text{ A}$		0.4	1	μs
	Storage Time	$V_{BB} = -5\text{ V}$ $I_{B1} = 1.8\text{ A}$		0.6	1	μs
	Fall Time	$R_B = 1.3\ \Omega$ $t_p = 30\ \mu\text{s}$		0.14	0.3	
t_s t_f t_t t_c t_c	INDUCTIVE LOAD					μs
	Storage Time	$V_{CC} = 100\text{ V}$ $I_C = 11\text{ A}$ $I_B = 1.1\text{ A}$		0.75	1.4	μs
	Fall Time	$V_{BB} = -5\text{ V}$ $V_{\text{clamp}} = 125\text{ V}$		0.08	0.2	μs
	Tail Time in Turn-on	$L_C = 0.25\text{ mH}$ $R_B = 2.3\ \Omega$		0.02	0.05	μs
	Crossover Time	see fig. 3		0.15	0.3	
t_s t_f t_t t_c t_c	Storage Time	$V_{CC} = 100\text{ V}$ $I_C = 11\text{ A}$ $I_B = 1.1\text{ A}$		0.95	1.7	μs
	Fall Time	$V_{BB} = -5\text{ V}$ $V_{\text{clamp}} = 125\text{ V}$		0.14	0.3	μs
	Tail Time in Turn-on	$L_C = 0.25\text{ mH}$ $R_B = 2.3\ \Omega$		0.04	0.1	μs
	Crossover Time	see fig. 3		0.3	0.5	μs
	Crossover Time	$T_j = 100\text{ }^\circ\text{C}$				
t_s t_f t_t t_t	Storage Time	$V_{CC} = 100\text{ V}$ $I_C = 11\text{ A}$ $I_B = 1.1\text{ A}$		1.8		μs
	Fall Time	$V_{BB} = 0$ $V_{\text{clamp}} = 125\text{ V}$		0.7		μs
	Tail Time in Turn-on	$L_C = 0.25\text{ mH}$ $R_B = 4.7\ \Omega$		0.2		μs
	Tail Time in Turn-on	see fig. 3				
t_s t_f t_t t_t	Storage Time	$V_{CC} = 100\text{ V}$ $I_C = 11\text{ A}$ $I_B = 1.1\text{ A}$		2.5		μs
	Fall Time	$V_{BB} = 0$ $V_{\text{clamp}} = 125\text{ V}$		1		μs
	Tail Time in Turn-on	$L_C = 0.25\text{ mH}$ $R_B = 4.7\ \Omega$		0.4		μs
	Tail Time in Turn-on	see fig. 3				

* Pulsed : Pulse duration = 300 μs , duty cycle = 2 %.

Figure 1 : Switching Times Test Circuit (resistive load).

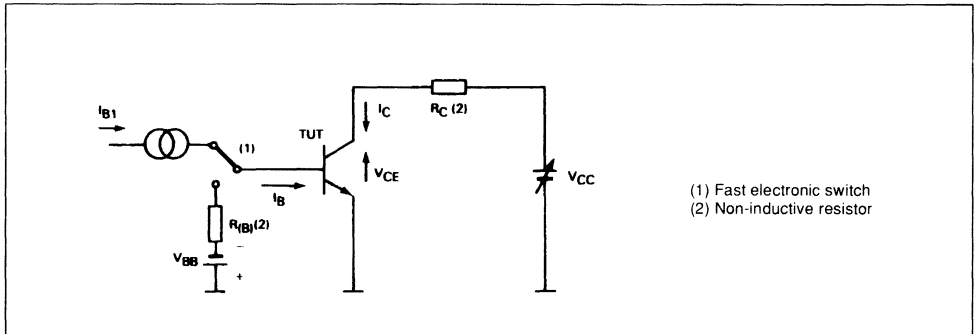

Figure 2 : Turn-on Switching Waveforms.

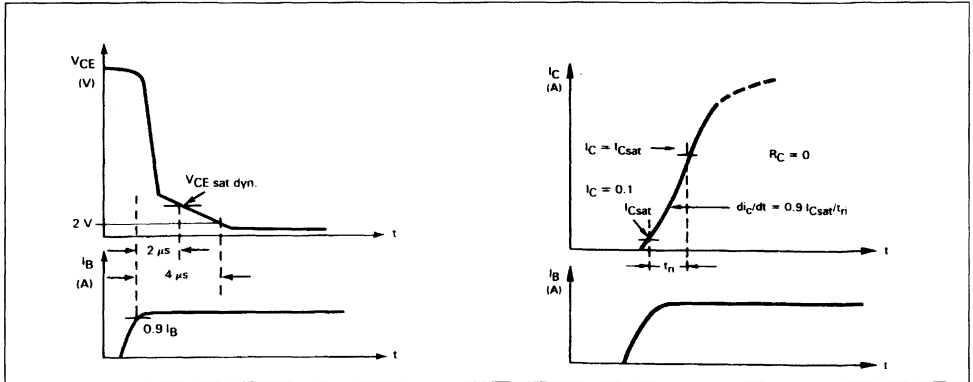

Figure 3a : Turn-off Switching Test Circuit.

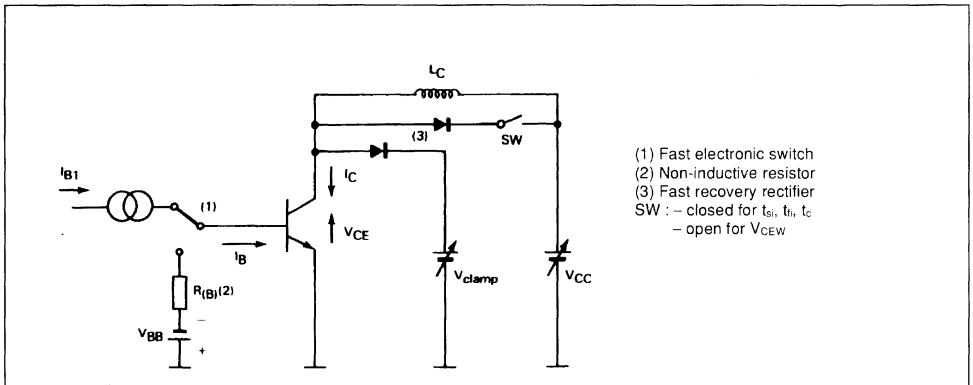
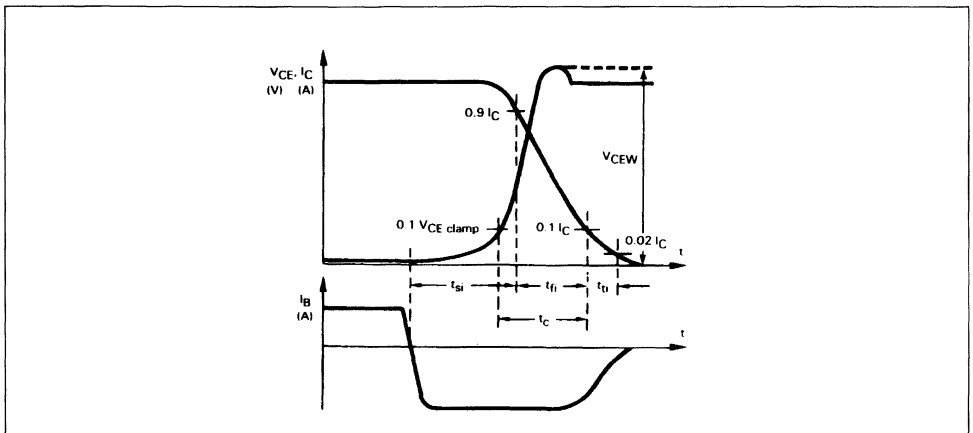
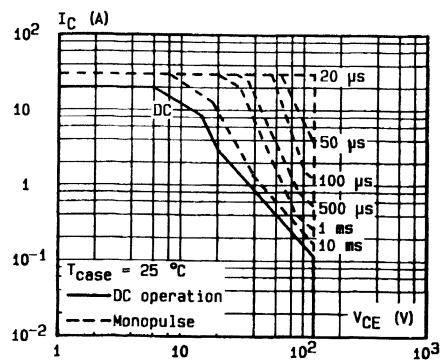

Figure 3b : Turn-off Switching Waveforms (inductive load).



DC and AC Pulse Area.



Power and $I_{S/B}$ Derating versus Case Temperature.

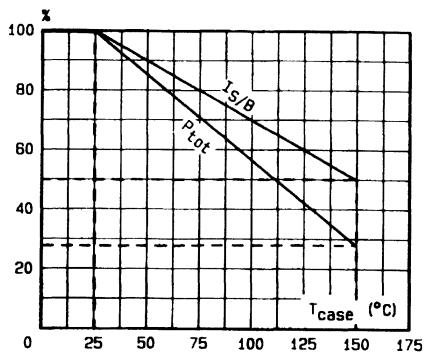

Transient Thermal Response.

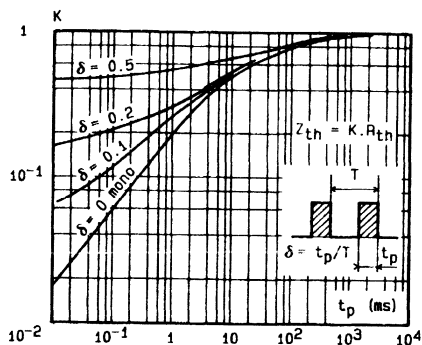

Collector-emitter Voltage versus Base-emitter Resistance.

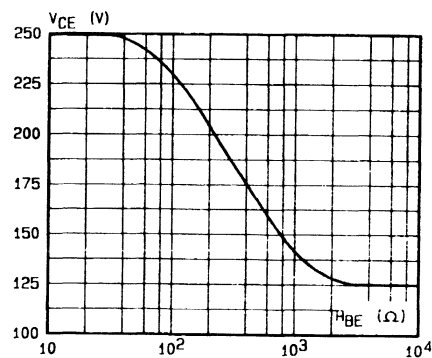

DC Current Gain.

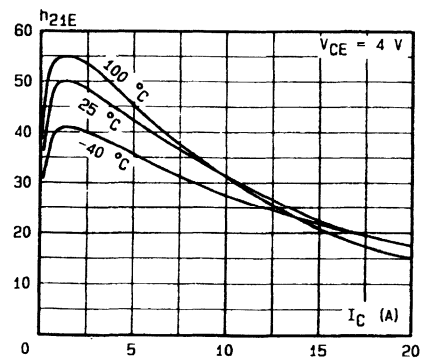

Minimum Base Current to Saturate the Transistor.

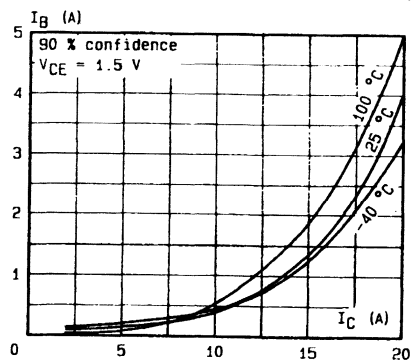

Saturation Voltage.

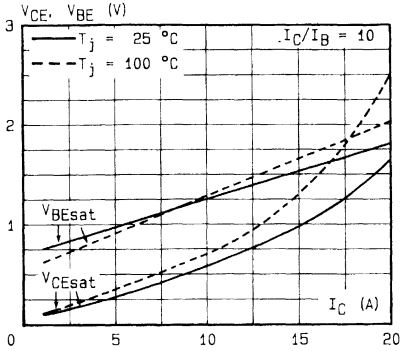

Saturation Voltage.

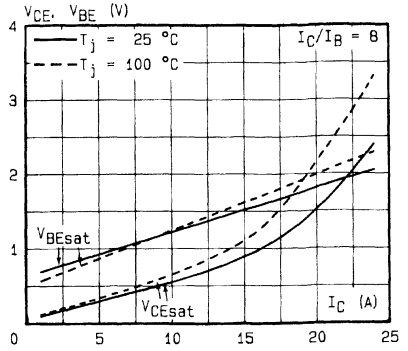

Switching Times versus Collector

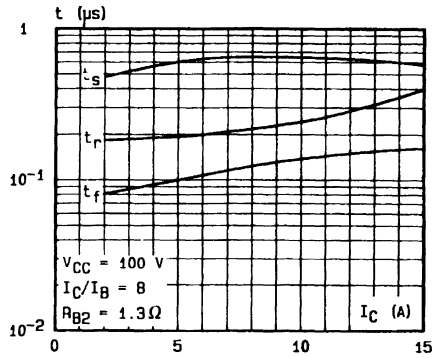

Switching Times versus Collector Current (inductive load).

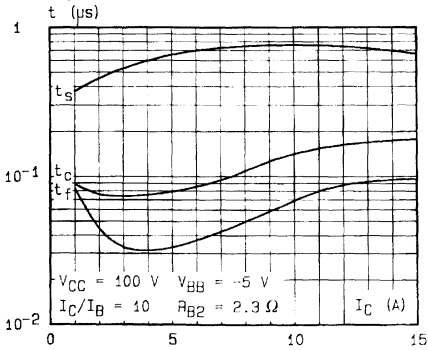

Switching Times versus Collector Current (inductive load).

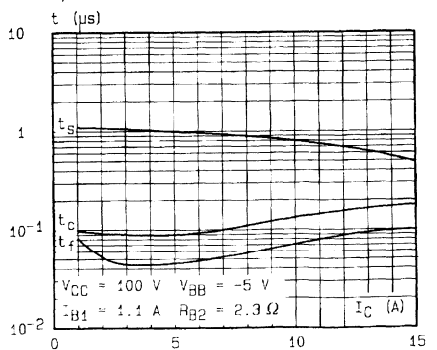

SWITCHING OPERATING AND OVERLOAD AREAS

TRANSISTOR FORWARD BIASED

- During the turn-on
- During the turn-off without negative base-emitter voltage and $4.7 \Omega \leq R_{BE} \leq 50 \Omega$.

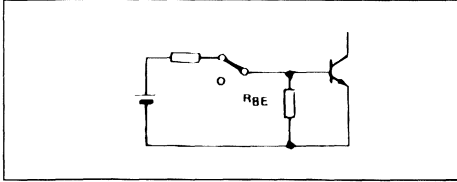

Forward Biased Safe Operating Area (FBSOA).

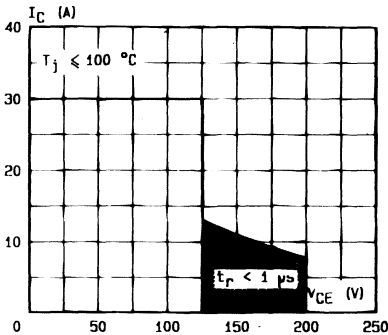

The hatched zone can only be used for turn-on.

Forward Biased Accidental Overload Area (FBADA).

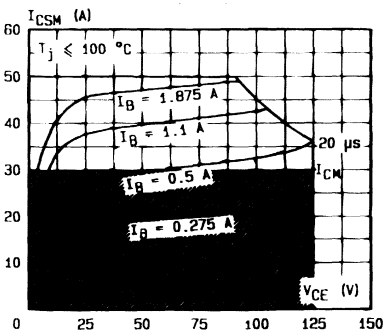

The Kellogg network (heavy point) allows the calculation of the maximum value of the short-circuit for a given base current I_B . (90 % confidence).

High accidental surge currents ($I > I_{CM}$) are allowed if they are non repetitive and applied less than 3000 times during the component life.

TRANSISTOR REVERSE BIASED

- During the turn-off with negative base-emitter voltage.

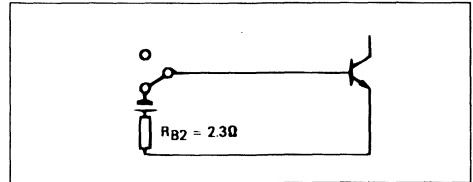

Reverse Biased Safe Operating Area (RBSOA).

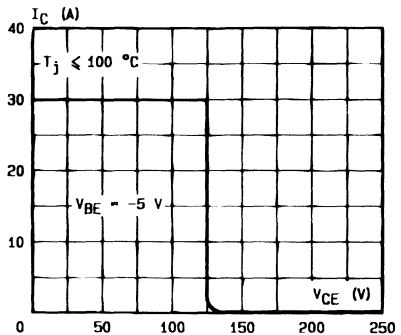

Reverse Biased Accidental Overload Area (RBADA).

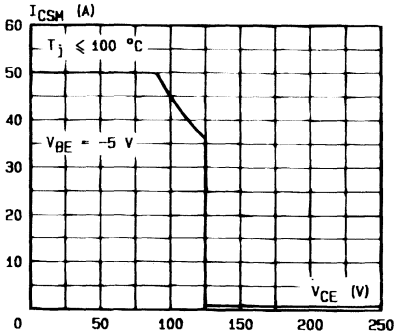

After the accidental overload current the RBAOA has to be used for the turn-off.

NPN FAST SWITCHING POWER TRANSISTOR

- VERY LOW SATURATION VOLTAGE AND HIGH GAIN FOR REDUCED LOAD OPERATION
- TURN-ON AND TURN-OFF TAIL SPECIFICATIONS
- TURN-ON di_c/dt FOR BETTER RECTIFIER CHOICE
- SWITCHING TIMES SPECIFIED WITH AND WITHOUT NEGATIVE BASE DRIVE
- FAST SWITCHING TIMES
- LOW SWITCHING LOSSES
- LOW ON-STATE VOLTAGE DROP
- BASE CURRENT REQUIREMENTS

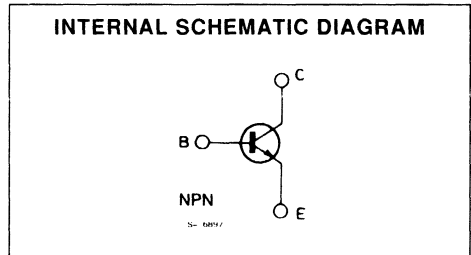
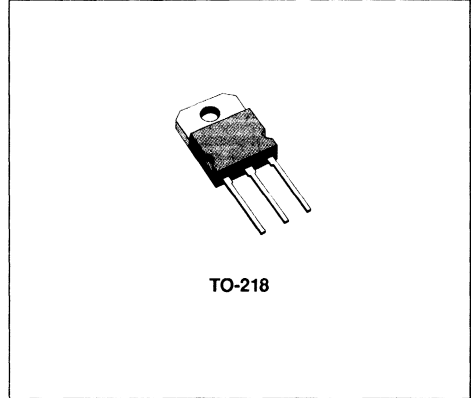

ABSOLUTE MAXIMUM RATINGS

Symbol	Parameter	Value	Unit
V_{CEV}	Collector-emitter Voltage ($V_{BE} = -1.5V$)	300	V
V_{CEO}	Collector-emitter Voltage ($I_B = 0$)	200	V
V_{EBO}	Emitter-base Voltage ($I_C = 0$)	7	V
I_C	Collector Current	15	A
I_{CM}	Collector Peak Current	20	A
I_B	Base Current	3	A
I_{BM}	Base Peak Current	5	A
P_{base}	Reverse bias Base Power Dissipation (B.E. junction in avalanche)	1	W
P_{tot}	Total Dissipation at $T_c < 25^\circ C$	125	W
T_{stg}	Storage Temperature	- 65 to 175	$^\circ C$
T_j	Max. Operating Junction Temperature	175	$^\circ C$

THERMAL DATA

$R_{th\ j-case}$	Thermal Resistance Junction-case	Max	1.2	°C/W
------------------	----------------------------------	-----	-----	------

ELECTRICAL CHARACTERISTICS ($T_{case} = 25^{\circ}C$ unless otherwise specified)

Symbol	Parameter	Test Conditions	Min.	Typ.	Max.	Unit	
I_{CER}	Collector Cutoff Current ($R_{BE} = 10\Omega$)	$V_{CE} = V_{CEV}$ $V_{CE} = V_{CEV}$ $T_c = 100^{\circ}C$			0.5 2.5	mA mA	
I_{CEV}	Collector Cutoff Current	$V_{CE} = V_{CEV}$ $V_{BE} = -1.5V$ $V_{CE} = V_{CEV}$ $V_{BE} = -1.5V$ $T_c = 100^{\circ}C$			0.5 2	mA mA	
I_{EBO}	Emitter Cutoff Current ($I_C = 0$)	$V_{EB} = 5V$			1	mA	
$V_{CEO(sus)*}$	Collector emitter Sustaining Voltage	$I_C = 0.2A$ $L = 25\text{ mH}$	200			V	
V_{EBO}	Emitter-base Voltage ($I_C = 0$)	$I_E = 5A$	7			V	
$V_{CE(sat)*}$	Collector-emitter Saturation Voltage	$I_C = 3A$ $I_B = 0.15A$ $I_C = 6A$ $I_B = 0.6A$ $I_C = 3A$ $I_B = 0.15A$ $T_j = 100^{\circ}C$ $I_C = 6A$ $I_B = 0.6A$ $T_j = 100^{\circ}C$		0.3 0.45 0.3 0.55	0.8 0.9 0.9 1.2	V V V V	
$V_{BE(sat)*}$	Base-emitter Saturation Voltage	$I_C = 6A$ $I_B = 0.6A$ $I_C = 6A$ $I_B = 0.6A$ $T_j = 100^{\circ}C$		1.15 1.15	1.6 1.6	V V	
di_c/dt	Rate of Rise of on State Collector Current	$V_{CC} = 160V$ $R_C = 0$ See fig. 2	$I_{B1} = 0.9A$ $T_j = 25^{\circ}C$ $T_j = 100^{\circ}C$	30 25	33 28	A/ μs A/ μs	
$V_{CE(2\mu s)}$	Collector-emitter Dynamic Voltage	$V_{CC} = 160V$ $R_C = 27\Omega$ See fig. 2	$I_{B1} = 0.6A$ $T_j = 25^{\circ}C$ $T_j = 100^{\circ}C$		1.05 1.53	2.5 4	V V
$V_{CE(4\mu s)}$	Collector-emitter Dynamic Voltage	$V_{CC} = 160V$ $R_C = 27\Omega$ See fig. 2	$I_{B1} = 0.6A$ $T_j = 25^{\circ}C$ $T_j = 100^{\circ}C$		0.75 0.95	1.7 2	V V

* Pulsed : Pulse duration = 300 μs , duty cycle = 2 %.

ELECTRICAL CHARACTERISTICS (continued)

Symbol	Parameter	Test Conditions		Min.	Typ.	Max.	Unit
t_r	RESISTIVE LOAD Rise Time	$V_{CC} = 160V$	$I_C = 8A$		0.3	0.5	μs
t_s	Storage Time	$V_{BB} = -5V$	$I_{B1} = 1A$		0.6	1.2	μs
t_f	Fall Time	$R_B = 2.5\Omega$	$t_p = 30\mu s$		0.12	0.3	μs
t_s	INDUCTIVE LOAD Storage Time	$V_{CC} = 160V$	$I_C = 6A$	$I_B = 0.6A$	0.75	1.5	μs
t_f	Fall Time	$V_{BB} = -5V$	$V_{clamp} = 200V$		0.08	0.2	μs
t_t	Tail Time in Turn-on	$L_C = 1.3mH$	$R_B = 4.2\Omega$		0.01	0.07	μs
t_c	Crossover Time	see fig. 3			0.12	0.3	μs
t_s	Storage Time	$V_{CC} = 160V$	$I_C = 6A$	$I_B = 0.6A$	1.2	2	μs
t_f	Fall Time	$V_{BB} = -5V$	$V_{clamp} = 200V$		0.12	0.3	μs
t_t	Tail Time in Turn-on	$L_C = 1.3mH$	$R_B = 4.2\Omega$		0.03	0.15	μs
t_c	Crossover Time	see fig. 3	$T_j = 100^\circ C$		0.22	0.5	μs
t_s	Storage Time	$V_{CC} = 160V$	$I_C = 6A$	$I_B = 0.6A$	1.8		μs
t_f	Fall Time	$V_{BB} = 0$	$V_{clamp} = 200V$		0.45		μs
t_t	Tail Time in Turn-on	$L_C = 1.3mH$	$R_B = 6.8\Omega$		0.15		μs
		see fig. 3	$T_j = 100^\circ C$				

* Pulsed : Pulse duration = 300 μs , duty cycle = 2 %.

Figure 1 : Switching Times Test Circuit (resistive load).

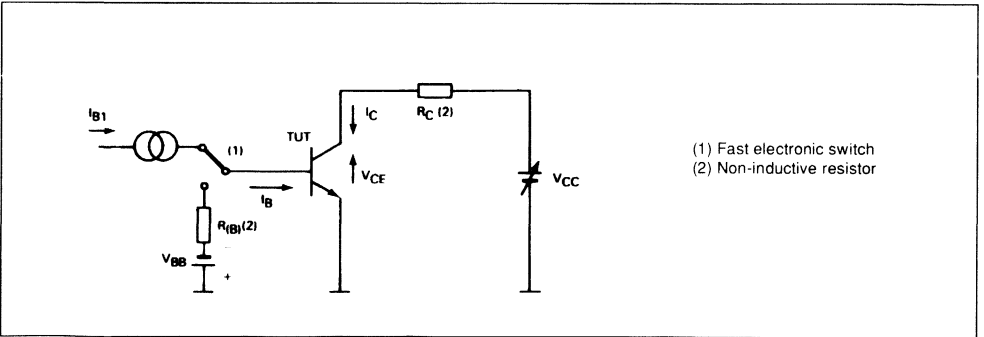

Figure 2 : Turn-on Switching Waveforms.

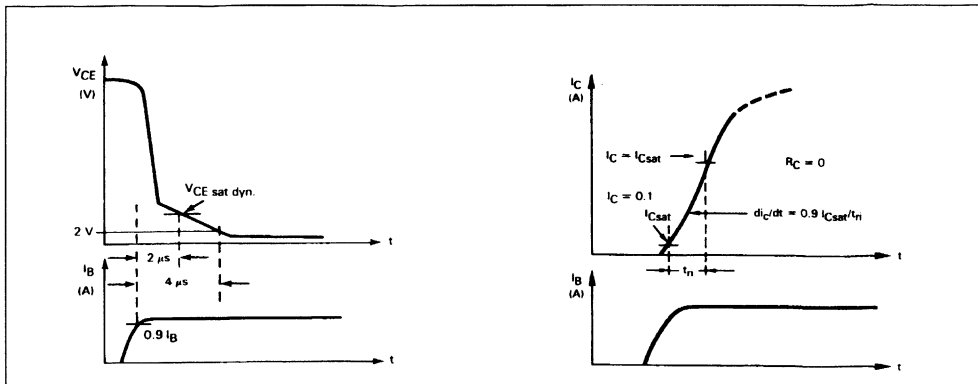

Figure 3a : Turn-off Switching Test Circuit.

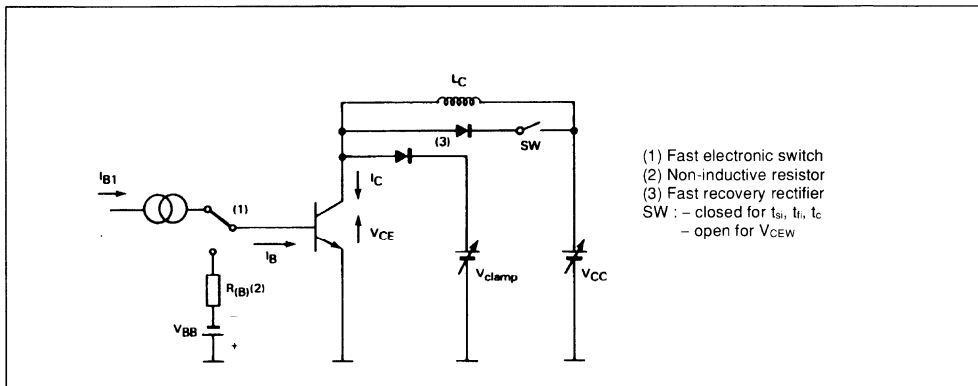
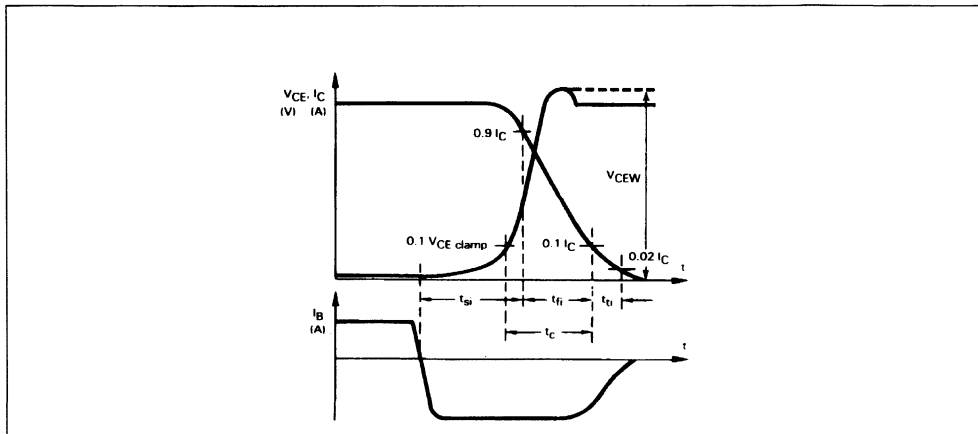
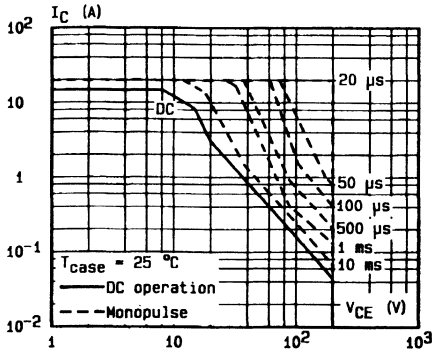

Figure 3b : Turn-off Switching Waveforms (inductive load).



DC and AC Pulse Area.



Power and $I_{S/B}$ Derating versus Case Temperature.

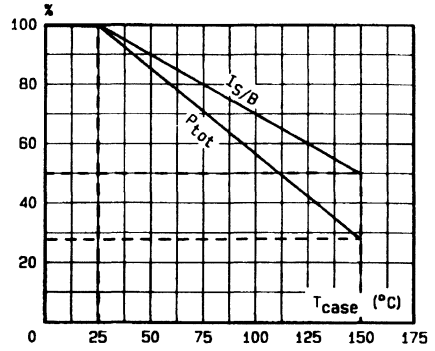

Transient Thermal Response.

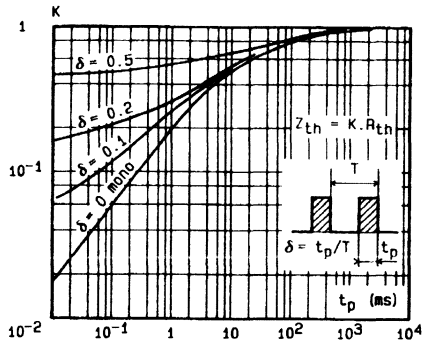

Collector-emitter Voltage versus Base-emitter Resistance.

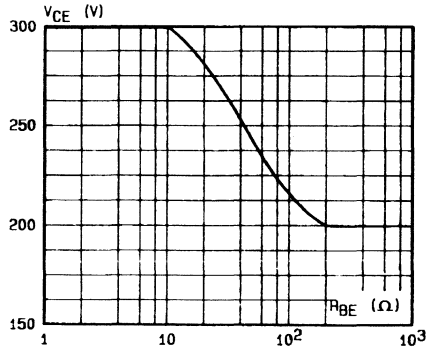

DC Current Gain.

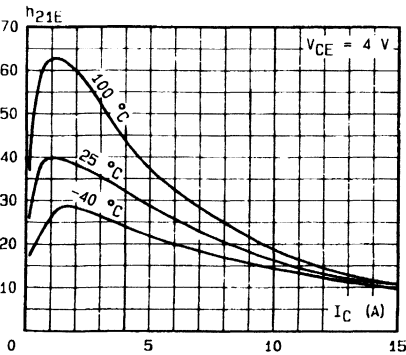

Minimum Base Current to Saturate the Transistor.

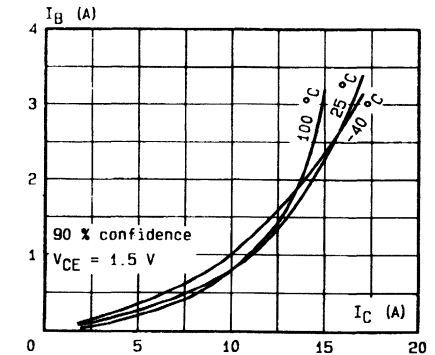

Saturation Voltage.

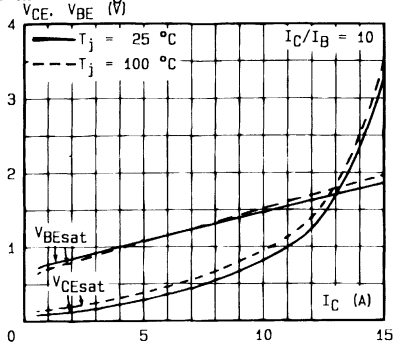

Saturation Voltage.

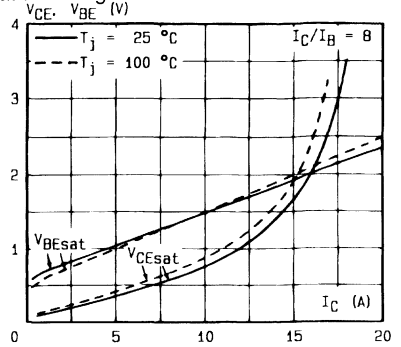

Switching Times versus Collector.

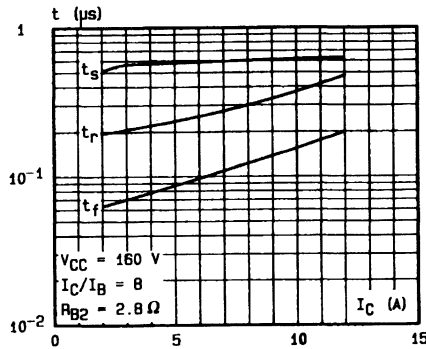

Switching Times versus Collector Current (inductive load).

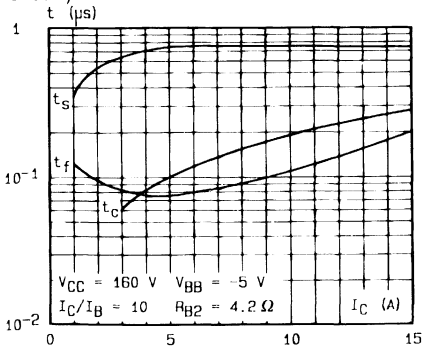

Switching Times versus Collector Current (inductive load).

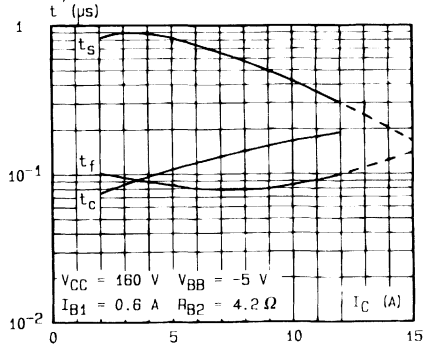

SWITCHING OPERATING AND OVERLOAD AREAS

TRANSISTOR FORWARD BIASED

- During the turn-on
- During the turn-off without negative base-emitter voltage and $6.8 \Omega \leq R_{BE} \leq 50 \Omega$.

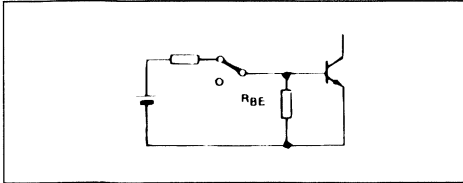

Forward Biased Safe Operating Area(FBSOA).

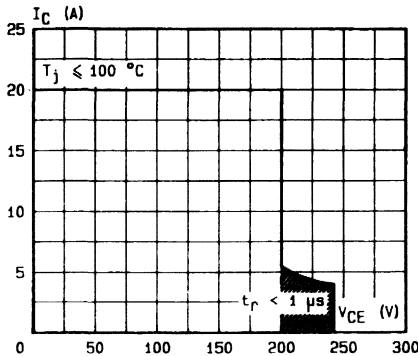

The hatched zone can only be used for turn-on

Forward Biased Accidental Overload Area (FBADA).

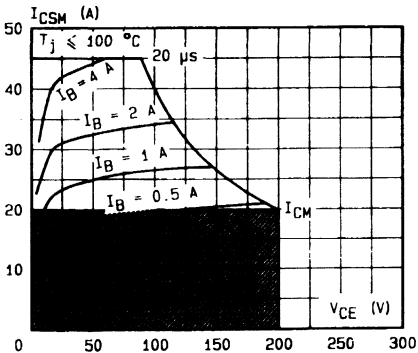

The Kellog network (heavy point) allows the calculation of the maximum value of the short-circuit for a given base current I_B . (90 % confidence).

High accidental surge currents ($I > I_{CM}$) are allowed if they are non repetitive and applied less than 3000 times during the component life.

TRANSISTOR REVERSE BIASED

- During the turn-off with negative base-emitter voltage.

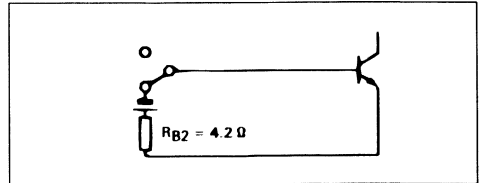

Reverse Biased Safe Operating Area (RBSOA).

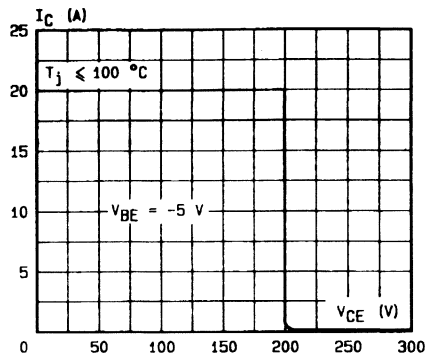

Reverse Biased Accidental Overload Area (RBADA).

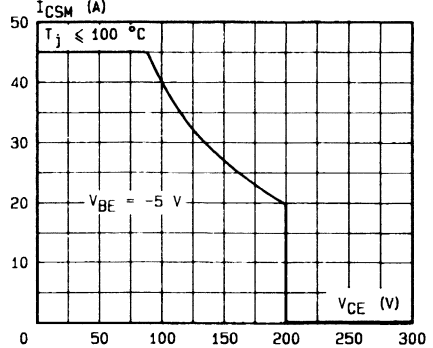

After the accidental overload current the RBAOA has to be used for the turn-off.

FAST SWITCHING POWER TRANSISTOR

- FAST SWITCHING TIMES
- LOW SWITCHING LOSSES
- VERY LOW SATURATION VOLTAGE AND HIGH GAIN

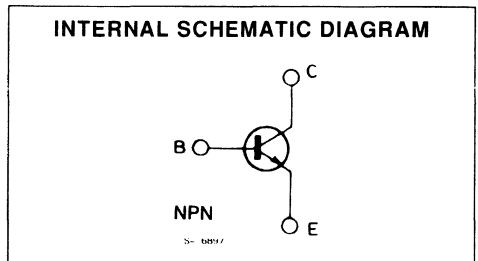
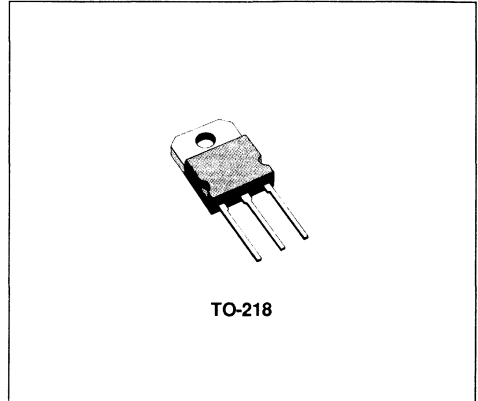
ABSOLUTE MAXIMUM RATINGS

Symbol	Parameter	Value	Unit
V_{CEV}	Collector-emitter Voltage ($V_{BE} = -1.5$ V)	350	V
V_{CEO}	Collector-emitter Voltage ($I_B = 0$)	250	V
V_{EBO}	Emitter-base Voltage ($I_C = 0$)	7	V
I_C	Collector Current	12	A
I_{CM}	Collector Peak Current	18	A
I_B	Base Current	2.5	A
I_{BM}	Base Peak Current	4	A
P_{base}	Reverse Bias Base Power Dissipation (B.E. junction in avalanche)	1	W
P_{tot}	Total Dissipation at $T_c < 25^\circ\text{C}$	125	W
T_{stg}	Storage Temperature	- 65 to 175	$^\circ\text{C}$
T_j	Max. Operating Junction Temperature	175	$^\circ\text{C}$

THERMAL DATA

$R_{th(j-case)}$	Thermal Resistance Junction-case	max	1.2	°C/W
------------------	----------------------------------	-----	-----	------

ELECTRICAL CHARACTERISTICS ($T_{case} = 25^{\circ}C$ unless otherwise specified)

Symbol	Parameter	Test Conditions	Min.	Typ.	Max.	Unit	
I_{CER}	Collector Cutoff Current ($R_{BE} = 10\Omega$)	$V_{CE} = V_{CEV}$ $V_{CE} = V_{CEV}$ $T_c = 100^{\circ}C$			0.5 2.5	mA mA	
I_{CEV}	Collector Cutoff Current	$V_{CE} = V_{CEV}$ $V_{BE} = -1.5V$ $V_{CE} = V_{CEV}$ $V_{BE} = -1.5V$ $T_c = 100^{\circ}C$			0.5 2	mA mA	
I_{EBO}	Emitter Cutoff Current ($I_C = 0$)	$V_{EB} = 5V$			1	mA	
$V_{CE0(sus)}^*$	Collector Emitter Sustaining Voltage	$I_C = 0.2A$ $L = 25mH$	250			V	
V_{EBO}	Emitter-base Voltage ($I_C = 0$)	$I_E = 50mA$	7			V	
$V_{CE(sat)}^*$	Collector-emitter Saturation Voltage	$I_C = 2A$ $I_B = 0.13A$ $I_C = 5A$ $I_B = 0.5A$ $I_C = 2A$ $I_B = 0.13A$ $T_j = 100^{\circ}C$ $I_C = 5A$ $I_B = 0.5A$ $T_j = 100^{\circ}C$		0.25 0.4 0.25 0.45	0.8 0.9 0.9 1.2	V V V V	
$V_{BE(sat)}^*$	Base-emitter Saturation Voltage	$I_C = 4A$ $I_B = 0.4A$ $I_C = 4A$ $I_B = 0.4A$ $T_j = 100^{\circ}C$		1 0.9	1.3 1.3	V V	
di_C/dt	Rated of Rise of on-state Collector Current	$V_{CC} = 200V$ $R_C = 0$ See fig. 2		25 20	40 35	A/ μs A/ μs	
$V_{CE(2\mu s)}$	Collector Emitter Dynamic Voltage	$V_{CC} = 200V$ $R_C = 50\Omega$ See fig. 2			1.7 2.5	2.5 4	V V
$V_{CE(4\mu s)}$	Collector Emitter Dynamic Voltage	$V_{CC} = 200V$ $R_C = 50\Omega$ See fig. 2			0.9 1.1	1.7 2	V V

ELECTRICAL CHARATERISTICS (continued)

RESISTIVE LOAD

Symbol	Parameter	Test Conditions		Min.	Typ.	Max.	Unit
t_r	Rise Time	$V_{CC} = 200V$	$I_C = 6A$		0.3	0.4	μs
t_s	Storage Time	$V_{BB} = -5V$ $R_{B2} = 3.3\Omega$	$I_{B1} = 0.75A$ $t_p = 30\mu s$		1	1.6	μs
t_f	Fall Time	See fig. 1			0.15	0.3	μs

INDUCTIVE LOAD

Symbol	Parameter	Test Conditions		Min.	Typ.	Max.	Unit
t_s	Storage Time	$V_{CC} = 200V$	$V_{clamp} = 250V$		1.2	1.8	μs
t_f	Fall Time	$I_C = 4A$	$I_B = 0.4A$		0.08	0.2	μs
t_t	Tail Time in Turn-on	$V_{BB} = -5V$ $L_C = 2.5mH$	$R_{B2} = 6.3\Omega$ See fig. 3		0.03	0.12	μs
t_c	Crossover Time				0.15	0.35	μs
t_s	Storage Time	$V_{CC} = 200V$	$V_{clamp} = 250V$		1.8	2.4	μs
t_f	Fall Time	$I_C = 4A$	$I_B = 0.4A$		0.2	0.4	μs
t_t	Tail Time in Turn-on	$V_{BB} = -5V$ $L_C = 2.5mH$	$R_{B2} = 6.3\Omega$ $T_j = 100^\circ C$		0.08	0.2	μs
t_c	Crossover Time	See fig. 3			0.4	0.7	μs
t_s	Storage Time	$V_{CC} = 200V$	$V_{clamp} = 250V$		2.5		μs
t_f	Fall Time	$I_C = 4A$	$I_B = 0.4A$		0.4		μs
t_t	Tail Time in Turn-on	$V_{BB} = 0$ $L_C = 2.5mH$	$R_{B2} = 7.5\Omega$ See fig. 3		0.15		μs
t_s	Storage Time	$V_{CC} = 200V$	$V_{clamp} = 250V$		4.8		μs
t_f	Fall Time	$I_C = 4A$	$I_B = 0.4A$		0.7		μs
t_t	Tail Time in Turn-on	$V_{BB} = 0$ $L_C = 2.5mH$	$R_{B2} = 7.5\Omega$ $T_j = 100^\circ C$		0.4		μs

* Pulsed : Pulse duration = 300 μs , duty cycle = 2 %.

Figure 1 : Switching Times Test Circuit (resistive load).

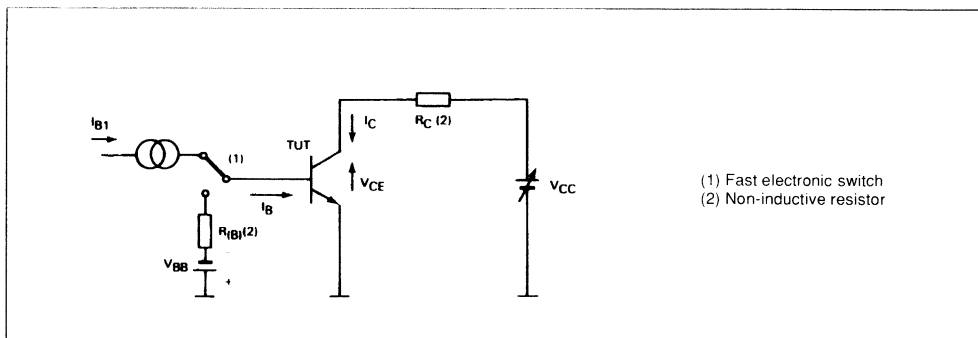

Figure 2 : Turn-on Switching Waveforms.

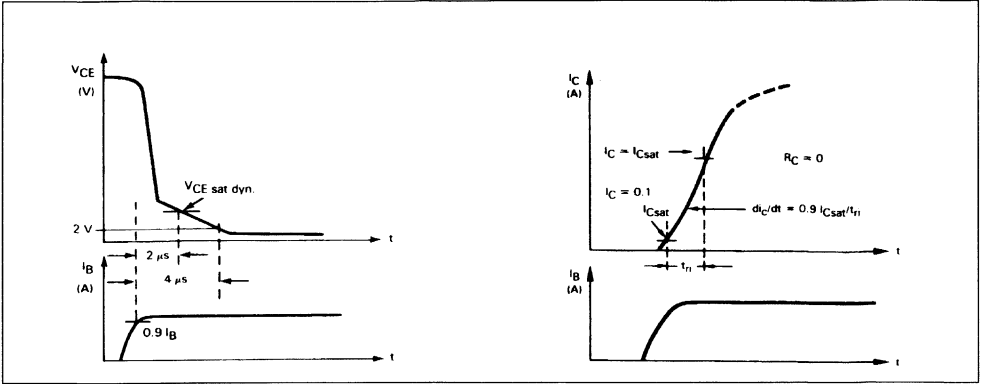

Figure 3a : Turn-off Switching Test Circuit.

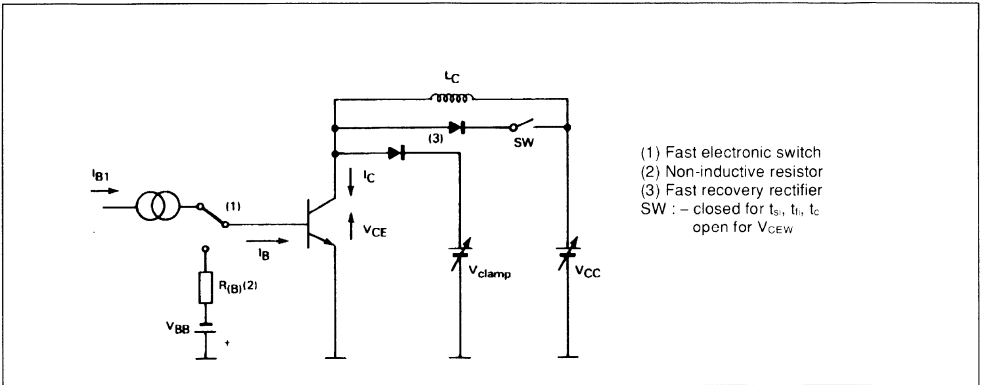
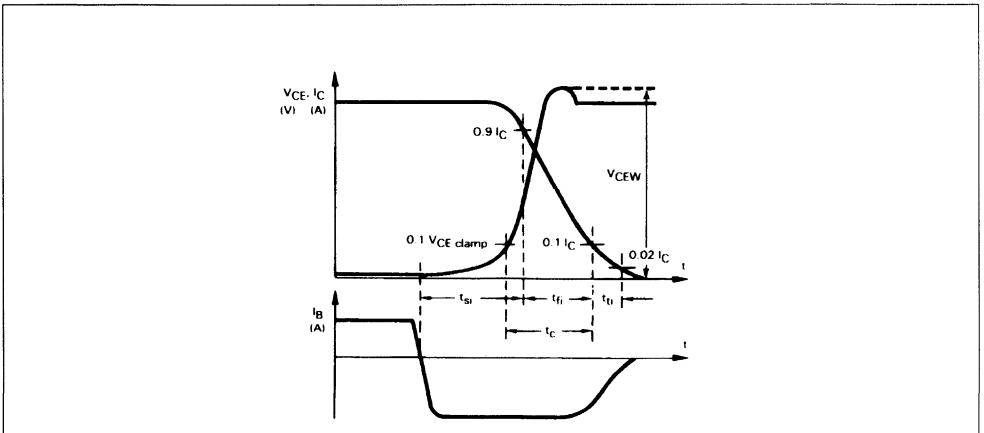
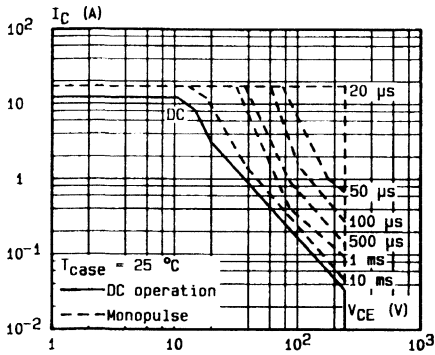

Figure 3b : Turn-off Switching Waveforms (inductive load).



DC and AC Pulse Area.



Power and $I_{S/B}$ Derating versus Case Temperature.

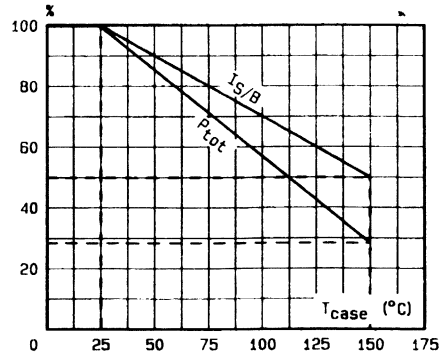

Transient Thermal Response.

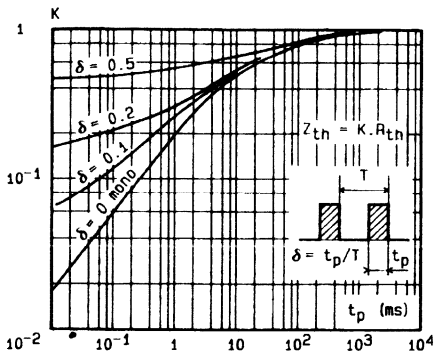

Collector-emitter Voltage versus Base-emitter Resistance.

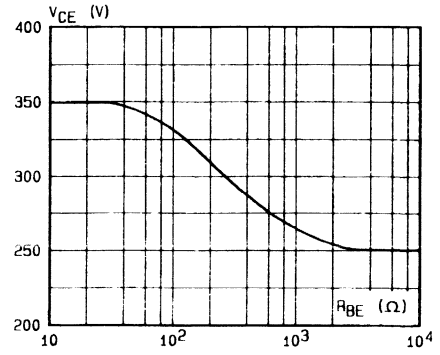

DC Current Gain.

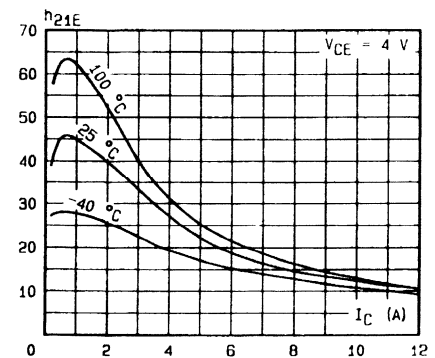

Minimum Base Current to Saturate the Transistor.

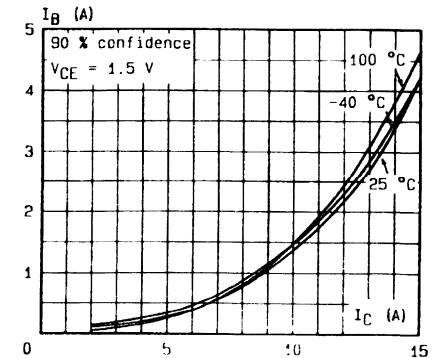

Saturation Voltage.

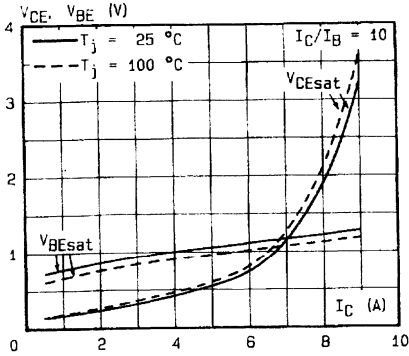

Saturation Voltage.

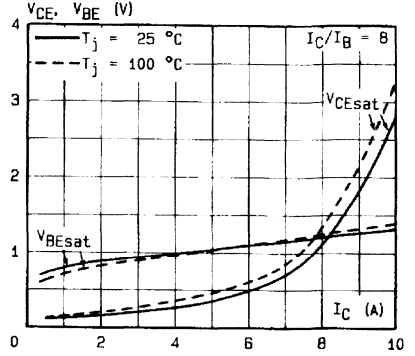

Switching Times versus Collector.

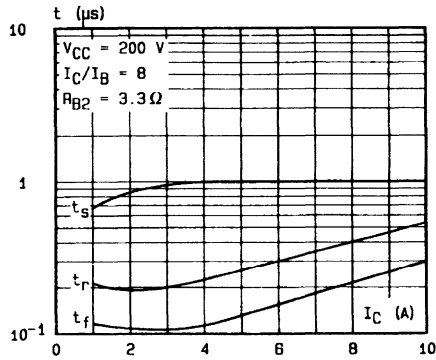

Switching Times versus Collector Current (inductive load).

Switching Times versus Collector Current (inductive load).

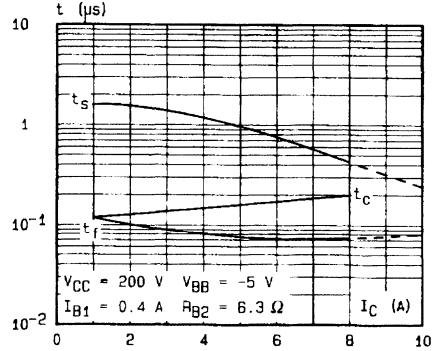
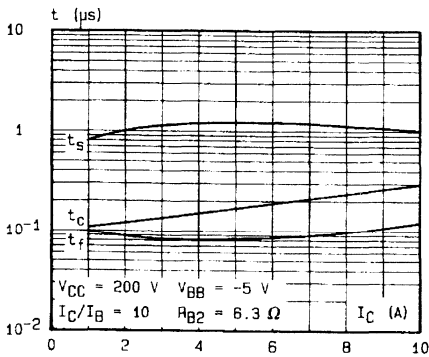

SWITCHING OPERATING AND OVERLOAD AREAS

TRANSISTOR FORWARD BIASED

- During the turn-on
- During the turn-off with negative base-emitter voltage and $7.5 \Omega \leq R_{BE} \leq 50 \Omega$.

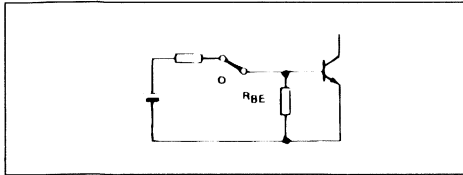

Forward Biased Safe Operating Area (FBSOA).

TRANSISTOR REVERSE BIASED

- During the turn-off with negative base-emitter voltage.

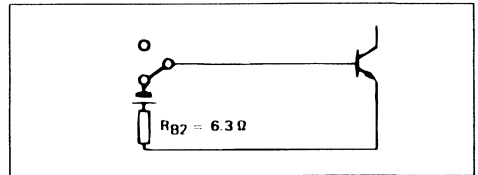

Reverse Biased Safe Operating Area (RBSOA).

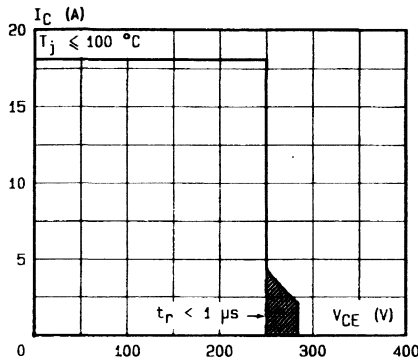

The hatched zone can only be used for turn-on.

Forward Biased Accidental Overload Area (FBAOA).

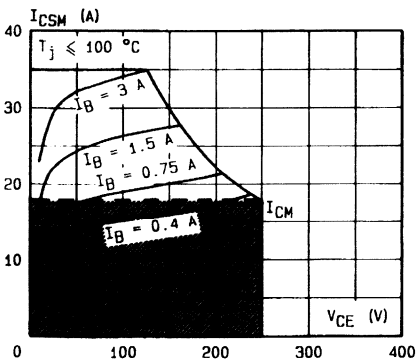

The Kellogg network (heavy point) allows the calculation of the maximum value of the short-circuit for a given base current I_B . (90 % confidence).

High accidental surge currents ($I > I_{CM}$) are allowed if they are non repetitive and applied less than 3000 times during the component life.

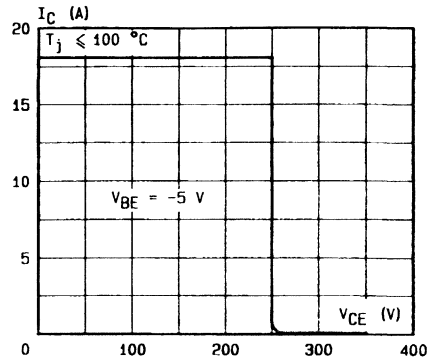

Reverse Biased Accidental Overload Area (RBAOA).

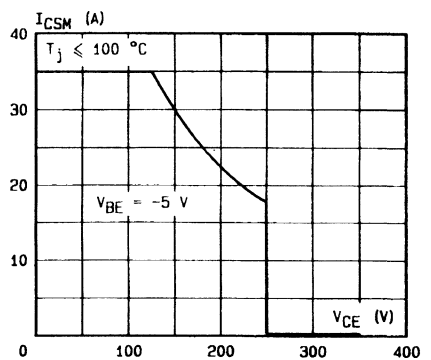

After the accidental overload current the RBAOA has to be used for the turn-off.

HIGH CURRENT, HIGH SPEED, HIGH POWER TRANSISTOR

DESCRIPTION

The BUX10 is a silicon multi-epitaxial planar NPN transistor in Jedec TO-3 metal case, intended for use in switching and linear applications in military and industrial equipment.

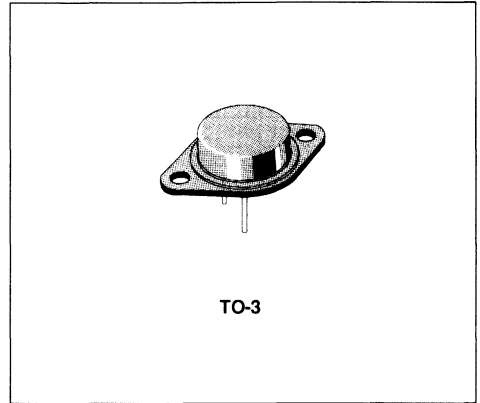

INTERNAL SCHEMATIC DIAGRAM

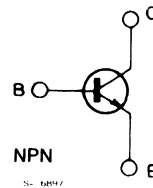

ABSOLUTE MAXIMUM RATINGS

Symbol	Parameter	Value	Unit
V_{CBO}	Collector-base Voltage ($I_E = 0$)	160	V
V_{CEX}	Collector-emitter Voltage ($V_{BE} = -1.5$ V)	160	V
V_{CEO}	Collector-emitter Voltage ($I_B = 0$)	125	V
V_{EBO}	Emitter-base Voltage ($I_C = 0$)	7	V
I_C	Collector Current	25	A
I_{CM}	Collector Peak Current ($t_p = 10$ ms)	30	A
I_B	Base Current	5	A
P_{tot}	Total Power Dissipation at $T_{case} \leq 25$ °C	150	W
T_{stg}	Storage Temperature	- 65 to 200	°C
T_j	Junction Temperature	200	°C

THERMAL DATA

R _{th j-case}	Thermal Resistance Junction-case	Max	1.17	°C/W
------------------------	----------------------------------	-----	------	------

ELECTRICAL CHARACTERISTICS (T_{case} = 25 °C unless otherwise specified)

Symbol	Parameter	Test Conditions	Min.	Typ.	Max.	Unit
I _{CEO}	Collector Cutoff Current (I _B = 0)	V _{CE} = 100 V			1.5	mA
I _{CEX}	Collector Cutoff Current	V _{CE} = 160 V V _{BE} = - 1.5 V T _{case} = 125 °C V _{CE} = 160 V V _{BE} = - 1.5 V			1.5 6	mA mA
I _{EBO}	Emitter Cutoff Current (I _C = 0)	V _{EB} = 5 V			1	mA
V _{CEO(sus)} *	Collector-emitter Sustaining Voltage	I _C = 200 mA	125			V
V _{EBO}	Emitter-base Voltage (I _C = 0)	I _E = 50 mA	7			V
V _{CE(sat)} *	Collector-emitter Saturation Voltage	I _C = 10 A I _B = 1 A I _C = 20 A I _B = 2 A		0.3 0.7	0.6 1.2	V V
V _{BE(sat)} *	Base-emitter Saturation Voltage	I _C = 20 A I _B = 2 A		1.6	2	V
h _{FE} *	DC Current Gain	I _C = 10 A V _{CE} = 2 V I _C = 20 A V _{CE} = 4 V	20 10		60	
I _{s/b}	Second Breakdown Collector Current	V _{CE} = 30 V t = 1 s V _{CE} = 48 V t = 1 s	5 1			A A
f _T	Transition Frequency	I _C = 1 A f = 10 MHz V _{CE} = 15 V	8			MHz
t _{on}	Turn-on Time (fig. 2)	I _C = 20 A V _{CC} = 30 V I _{B1} = 2 A		0.5	1.5	µs
t _s	Storage Time (fig. 2)	I _C = 20 A V _{CC} = 30 V I _{B1} = - I _{B2} = 2 A		0.6	1.2	µs
t _f	Fall Time (fig. 2)			0.15	0.3	µs
	Clamped E _{s/b} Collector Current (fig. 1)	V _{clamp} = 125 V L = 500 µH	20			A

* Pulsed : pulse duration = 300 µs, duty cycle ≤ 2 %.

Safe Operating Areas.

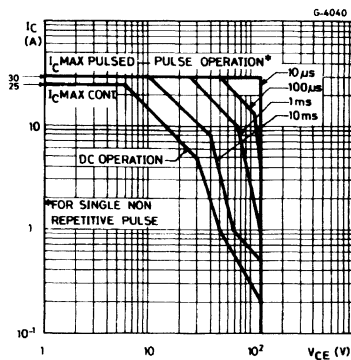

Derating Curves.

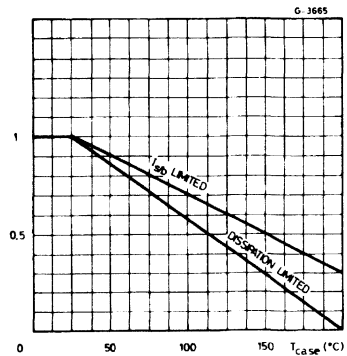

Thermal Transient Response.

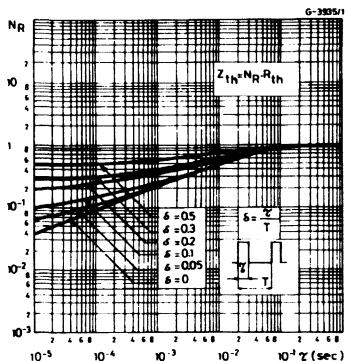

DC Current Gain.

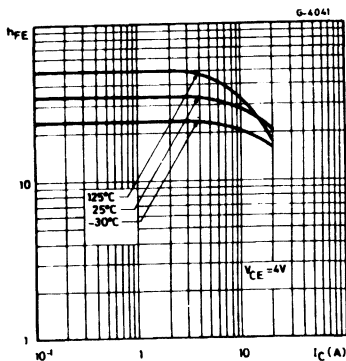

Collector-emitter Saturation Voltage.

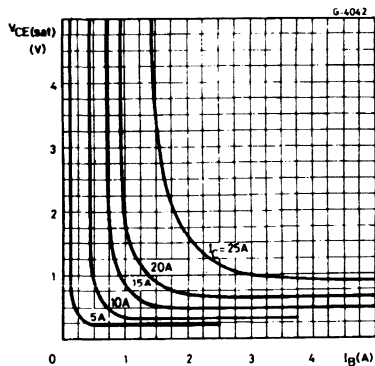

Collector-emitter Saturation Voltage.

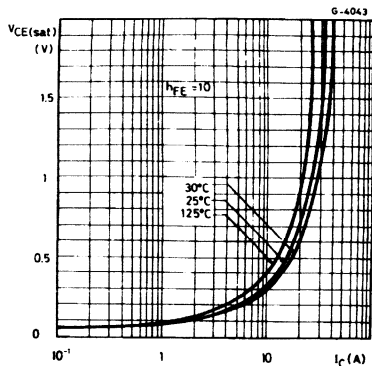

Base-emitter Saturation Voltage.

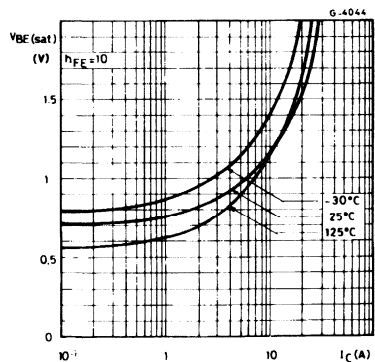

Saturated Switching Characteristics.

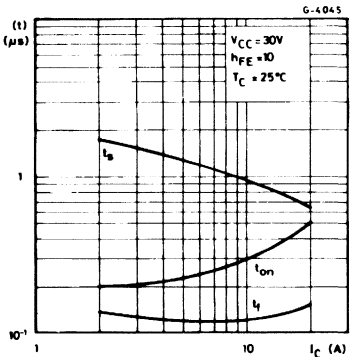

Saturated Switching Characteristics.

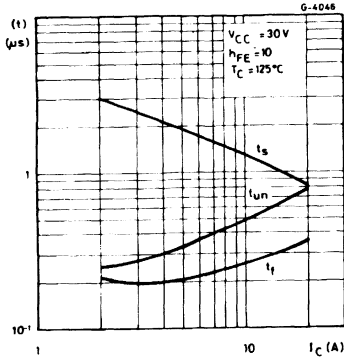

Collector-base Capacitance.

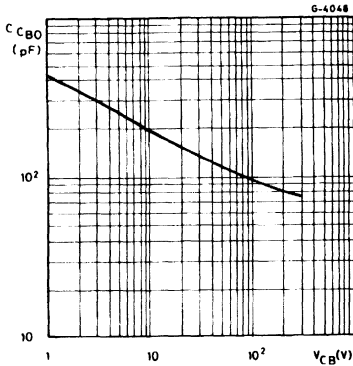
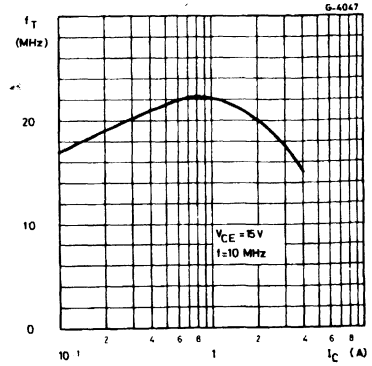

Figure 1 : Clamped $E_{s/b}$ Test Circuit.

Transition Frequency.



Clamped Reverse Bias Safe Operating Area.

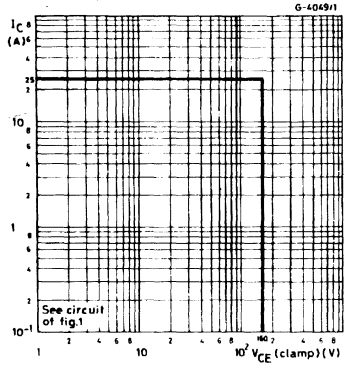
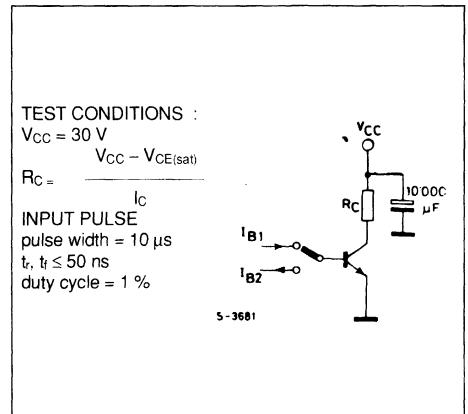
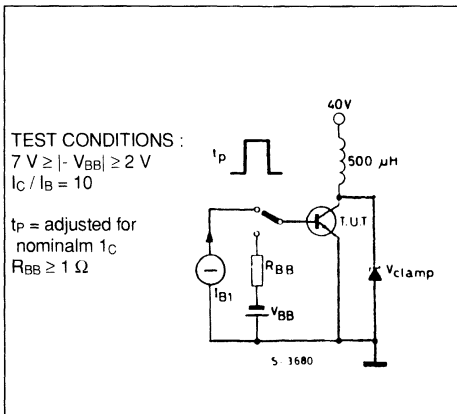

Figure 2 : Switching Times Test Circuit (resistive load).



HIGH CURRENT, HIGH SPEED, POWER TRANSISTOR

ADVANCE DATA

DESCRIPTION

The BUX10P is a silicon multi-epitaxial planar NPN transistor in SOT-93 case, intended for use in switching and linear applications in military and industrial equipment.

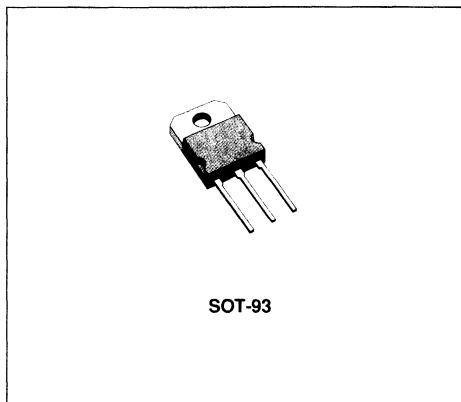

INTERNAL SCHEMATIC DIAGRAM

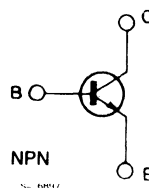

ABSOLUTE MAXIMUM RATINGS

Symbol	Parameter	Value	Unit
V_{CBO}	Collector-base Voltage ($I_E = 0$)	160	V
V_{CEX}	Collector-emitter Voltage ($V_{BE} = 1.5$ V)	160	V
V_{CEO}	Collector-emitter ($I_B = 0$)	125	V
V_{EBO}	Emitter-base Voltage ($I_C = 0$)	7	V
I_C	Collector Current	25	A
I_{CM}	Collector Peak Current ($t_p = 10$ ms)	30	A
I_B	Base Current	5	A
P_{tot}	Total Power Dissipation at $T_{case} \leq 25$ °C	106	W
T_{stg}	Storage Temperature	- 65 to 150	°C
T_j	Junction Temperature	150	°C

THERMAL DATA

$R_{th\ j-case}$	Thermal Resistance Junction-case	Max	1.17	°C/W
------------------	----------------------------------	-----	------	------

ELECTRICAL CHARACTERISTICS ($T_{case} = 25\text{ °C}$ unless otherwise specified)

Symbol	Parameter	Test Conditions	Min.	Typ.	Max.	Unit
I_{CEO}	Collector Cutoff Current ($I_B = 0$)	$V_{CE} = 100\text{ V}$			1.5	mA
I_{CEX}	Collector Cutoff Current	$V_{CE} = 160\text{ V}$ $V_{BE} = -1.5\text{ V}$			1.5	mA
		$T_{case} = 125\text{ °C}$ $V_{CE} = 160\text{ V}$ $V_{BE} = -1.5\text{ V}$			6	mA
I_{EBO}	Emitter Cutoff Current ($I_C = 0$)	$V_{EB} = 5\text{ V}$			1	mA
$V_{CEO(sus)}$	Collector-emitter Sustaining Voltage	$I_C = 200\text{ mA}$	125			V
V_{EBO}	Emitter-base Voltage ($I_C = 0$)	$I_E = 50\text{ mA}$	7			V
$V_{CE(sat)}$	Collector-emitter Saturation Voltage	$I_C = 10\text{ A}$ $I_B = 1\text{ A}$		0.3	0.6	V
		$I_C = 20\text{ A}$ $I_B = 2\text{ A}$		0.7	1.2	V
$V_{BE(sat)}$	Base-emitter Saturation Voltage	$I_C = 20\text{ A}$ $I_B = 2\text{ A}$		1.6	2	V
h_{FE}	DC Current Gain	$I_C = 10\text{ A}$ $V_{CE} = 2\text{ V}$	20		60	
		$I_C = 20\text{ A}$ $V_{CE} = 4\text{ V}$	10			
$I_{s/b}$	Second Breakdown Collector Current	$V_{CE} = 30\text{ V}$ $t = 1\text{ s}$	3.53			A
		$V_{CE} = 48\text{ V}$ $t = 1\text{ s}$	1			A
f_T	Transition Frequency	$I_C = 1\text{ A}$ $f = 10\text{ MHz}$ $V_{CE} = 15\text{ V}$	8			MHz
t_{on}	Turn-on Time	$I_C = 20\text{ A}$ $V_{CC} = 30\text{ V}$ $I_{B1} = 2\text{ A}$		0.5	1.5	μs
t_s	Storage Time	$I_C = 20\text{ A}$ $V_{CC} = 30\text{ V}$ $I_{B1} = I_{B2} = 2\text{ A}$		0.6	1.2	μs
t_f	Fall Time			0.15	0.3	μs
	Clamped $E_{s/b}$ Collector Current	$V_{clamp} = 125\text{ V}$ $L = 500\text{ μH}$	20			A

Safe Operating Areas.

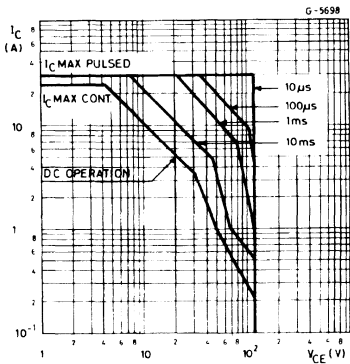

HIGH CURRENT, HIGH SPEED, HIGH POWER TRANSISTOR

DESCRIPTION

The BUX11 is a silicon multiepitaxial NPN transistor in Jedec TO-3 metal case, intended for use in switching and linear applications in military and industrial equipment.

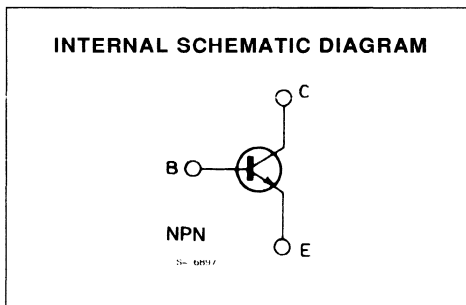
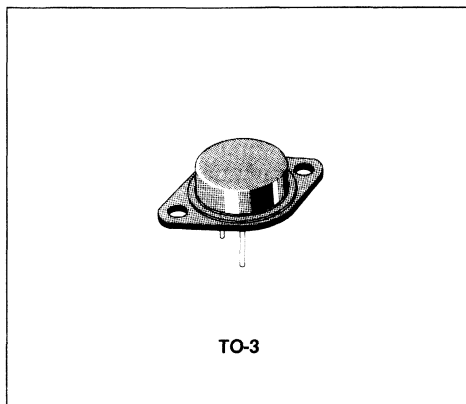

ABSOLUTE MAXIMUM RATINGS

Symbol	Parameter	Value	Unit
V_{CBO}	Collector-base Voltage ($I_E = 0$)	250	V
V_{CEX}	Collector-emitter Voltage ($V_{BE} = -1.5$ V)	250	V
V_{CEO}	Collector-emitter Voltage ($I_B = 0$)	200	V
V_{EBO}	Emitter-base Voltage ($I_C = 0$)	7	V
I_C	Collector Current	20	A
I_{CM}	Collector Peak Current ($t_p = 10$ ms)	25	A
I_B	Base Current	4	A
P_{tot}	Total Power Dissipation at $T_{case} \leq 25$ °C	150	W
T_{stg}	Storage Temperature	- 65 to 200	°C
T_j	Junction Temperature	200	°C

THERMAL DATA

$R_{th\ j-case}$	Thermal Resistance Junction-case	Max	1.17	$^{\circ}C/W$
------------------	----------------------------------	-----	------	---------------

ELECTRICAL CHARACTERISTICS ($T_{case} = 25\ ^{\circ}C$ unless otherwise specified)

Symbol	Parameter	Test Conditions	Min.	Typ.	Max.	Unit
I_{CEO}	Collector Cutoff Current ($I_B = 0$)	$V_{CE} = 160\ V$			1.5	mA
I_{CEX}	Collector Cutoff Current	$V_{CE} = 250\ V$ $V_{BE} = -1.5\ V$ $V_{CE} = 250\ V$ $V_{BE} = -1.5\ V$ $T_{case} = 125\ ^{\circ}C$			1.5 6	mA mA
I_{EBO}	Emitter Cutoff Current ($I_C = 0$)	$V_{EB} = 5\ V$			1	mA
$V_{CEO(sus)}^*$	Collector-emitter Sustaining Voltage	$I_C = 200\ mA$	200			V
V_{EBO}	Emitter-base Voltage ($I_C = 0$)	$I_E = 50\ mA$	7			V
$V_{CE(sat)}^*$	Collector-emitter Saturation Voltage	$I_C = 6\ A$ $I_B = 0.6\ A$ $I_C = 12\ A$ $I_B = 1.5\ A$		0.3 0.6	0.6 1.5	V V
$V_{BE(sat)}^*$	Base-emitter Saturation Voltage	$I_C = 12\ A$ $I_B = 1.5\ A$		1.3	1.5	V
h_{FE}^*	DC Current Gain	$I_C = 6\ A$ $V_{CE} = 2\ V$ $I_C = 12\ A$ $V_{CE} = 4\ V$	20 10		60	
$I_{s/b}$	Second Breakdown Collector Current	$V_{CE} = 30\ V$ $t = 1\ s$ $V_{CE} = 140\ V$ $t = 1\ s$	5 0.15			A A
f_T	Transition Frequency	$I_C = 1\ A$ $f = 10\ MHz$ $V_{CE} = 15\ V$	8			MHz
t_{on}	Turn-on Time (fig. 2)	$I_C = 12\ A$ $V_{CC} = 150\ V$ $I_{B1} = 1.5\ A$		0.3	1	μs
t_s	Storage Time (fig. 2)	$I_C = 12\ A$ $I_{B1} = 1.5\ A$ $I_{B2} = -1.5\ A$ $V_{CC} = 150\ V$		1.2	1.8	μs
t_f	Fall Time (fig. 2)			0.24	0.4	μs
	Clamped $E_{s/b}$ Collector Current (fig. 1)	$V_{clamp} = 200\ V$ $L = 500\ \mu H$	12			A

* Pulsed : pulse duration = 300 μs , duty cycle $\leq 2\ %$.

Safe Operating Areas.

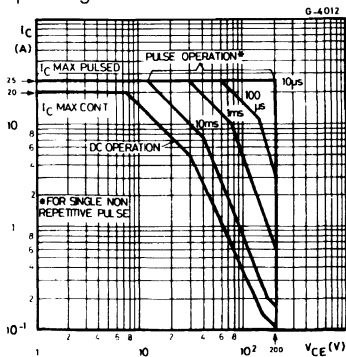

Derating Curves.

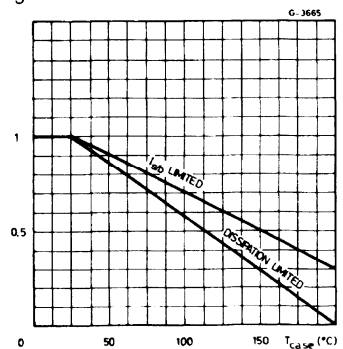

Thermal Transient Response.

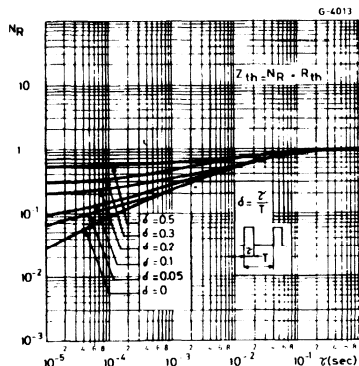

DC Current Gain.

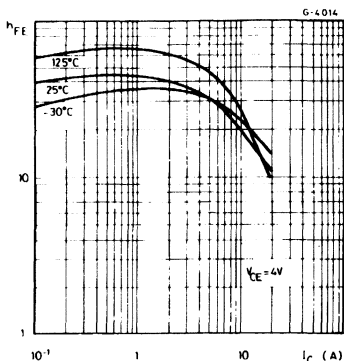

Collector-emitter Saturation Voltage.

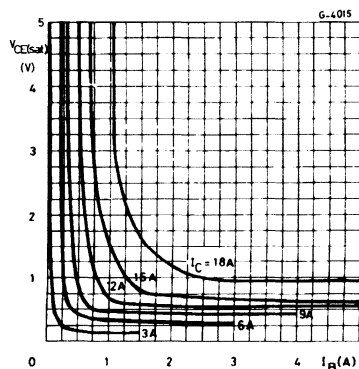

Collector-emitter Saturation Voltage.

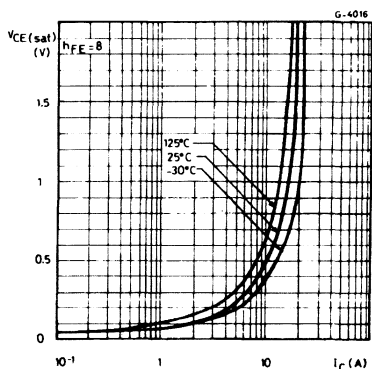

Base-emitter Saturation Voltage.

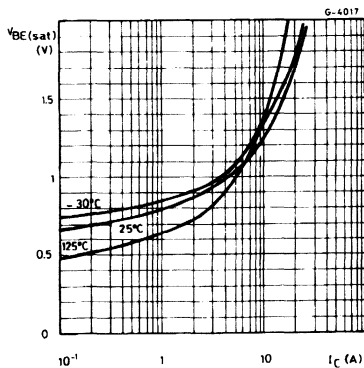

Saturated Switching Characteristics.

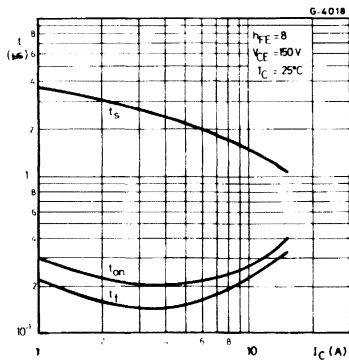

Saturated Switching Characteristics.

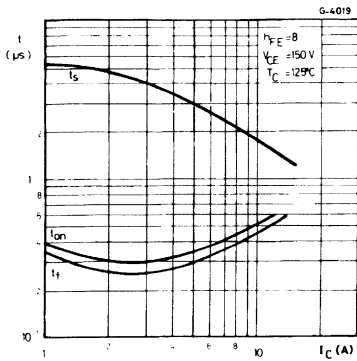

Transition Frequency.

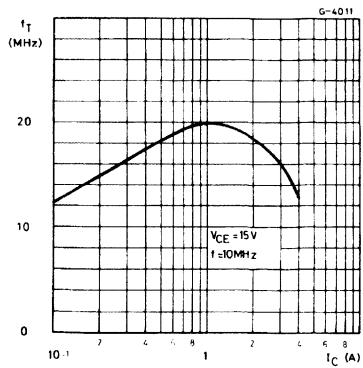

Collector-base Capacitance.

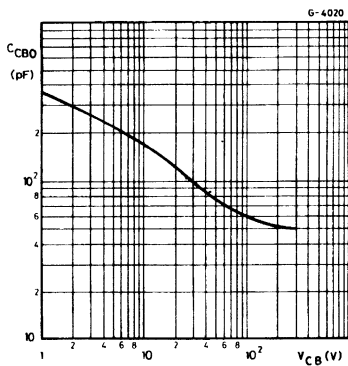

Clamped Reverse Bias Safe Operating Area.

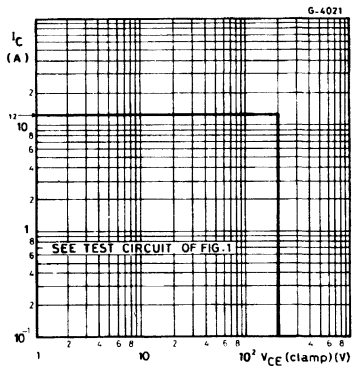
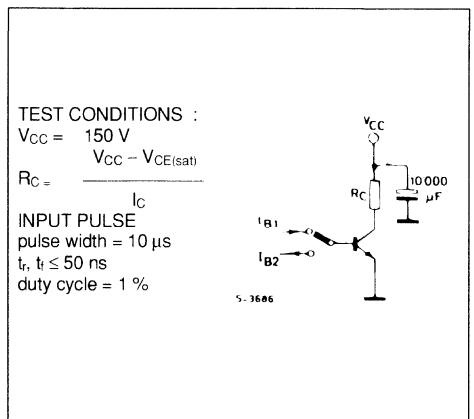
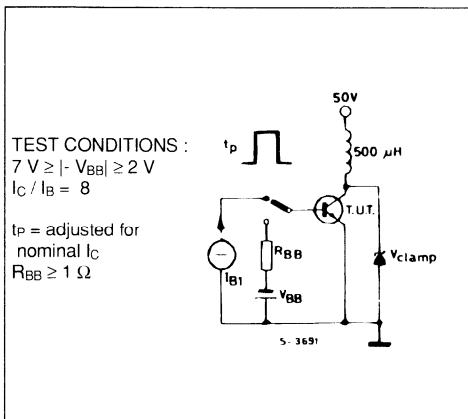

Figure 1 : Clamped $E_{s,b}$ Test Circuit.

Figure 2 : Switching Times Test Circuit (resistive load).



HIGH CURRENT, HIGH SPEED, HIGH POWER TRANSISTOR

DESCRIPTION

The BUX11 is a silicon multiepitaxial NPN transistor in Jedec TO-3 metal case, intended for use in switching and linear applications in military and industrial equipment.

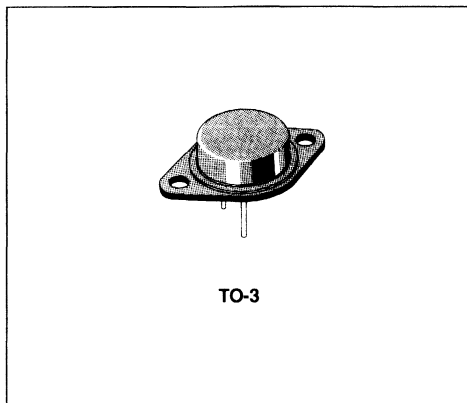

INTERNAL SCHEMATIC DIAGRAM

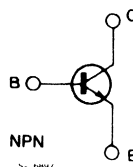

ABSOLUTE MAXIMUM RATINGS

Symbol	Parameter	Value	Unit
V_{CBO}	Collector-base Voltage ($I_E = 0$)	220	V
V_{CEX}	Collector-emitter Voltage ($V_{BE} = -1.5$ V)	220	V
V_{CEO}	Collector-emitter Voltage ($I_B = 0$)	160	V
V_{EBO}	Emitter-base Voltage ($I_C = 0$)	7	V
I_C	Collector Current	20	A
I_{CM}	Collector Peak Current ($t_p = 10$ ms)	25	A
I_B	Base Current	5	A
P_{tot}	Total Power Dissipation at $T_{case} \leq 25$ °C	150	W
T_{stg}	Storage Temperature	- 65 to 200	°C
T_j	Junction Temperature	200	°C

THERMAL DATA

$R_{th\ j-case}$	Thermal Resistance Junction-case	Max	1.17	$^{\circ}C/W$
------------------	----------------------------------	-----	------	---------------

ELECTRICAL CHARACTERISTICS ($T_{case} = 25\ ^{\circ}C$ unless otherwise specified)

Symbol	Parameter	Test Conditions	Min.	Typ.	Max.	Unit
I_{CEO}	Collector Cutoff Current ($I_B = 0$)	$V_{CE} = 130\ V$			1.5	mA
I_{CEX}	Collector Cutoff Current	$V_{CE} = 220\ V$ $V_{BE} = -1.5\ V$ $V_{CE} = 220\ V$ $V_{BE} = -1.5\ V$ $T_{case} = 125\ ^{\circ}C$			1.5 6	mA mA
I_{EBO}	Emitter Cutoff Current ($I_C = 0$)	$V_{EB} = 5\ V$			1	mA
$V_{CEO(sus)}^*$	Collector-emitter Sustaining Voltage	$I_C = 200\ mA$ $L = 25\ mH$	160			V
V_{EBO}	Emitter-base Voltage ($I_C = 0$)	$I_E = 50\ mA$	7			V
$V_{CE(sat)}^*$	Collector-emitter Saturation Voltage	$I_C = 8\ A$ $I_B = 0.8\ A$ $I_C = 15\ A$ $I_B = 1.88\ A$		0.3 0.6	0.6 1.5	V V
$V_{BE(sat)}^*$	Base-emitter Saturation Voltage	$I_C = 15\ A$ $I_B = 1.88\ A$		1.4	1.8	V
h_{FE}^*	DC Current Gain	$I_C = 8\ A$ $V_{CE} = 2\ V$ $I_C = 15\ A$ $V_{CE} = 4\ V$	20 10		60	
$I_{s/b}$	Second Breakdown Collector Current	$V_{CE} = 30\ V$ $t = 1\ s$ $V_{CE} = 140\ V$ $t = 1\ s$	5 0.15			A A
f_T	Transition Frequency	$V_{CE} = 15\ V$ $f = 10\ MHz$ $I_C = 1\ A$	8			MHz
t_{on}	Turn-on Time (fig. 2)	$I_C = 15\ A$ $V_{CC} = 30\ V$ $I_{B1} = 1.88\ A$		0.4	1.5	μs
t_s	Storage Time (fig. 2)	$I_C = 15\ A$ $V_{CC} = 30\ V$ $I_{B1} = -I_{B2} = 1.88\ A$		0.75	1.5	μs
t_f	Fall Time (fig. 2)			0.14	0.5	μs
	Clamped $E_{s/b}$ Collector Current (fig. 1)	$V_{clamp} = 160\ V$ $L = 500\ \mu H$	15			A

* Pulsed : pulse duration = 300 μs , duty cycle $\leq 2\%$.

Safe Operating Areas.

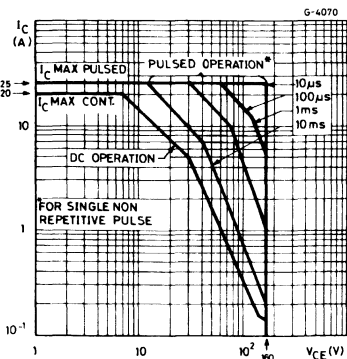

Derating Curves.

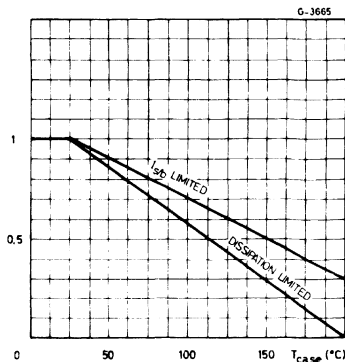

Thermal transient Response.

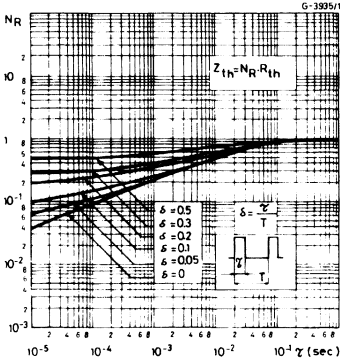

DC Current Gain.

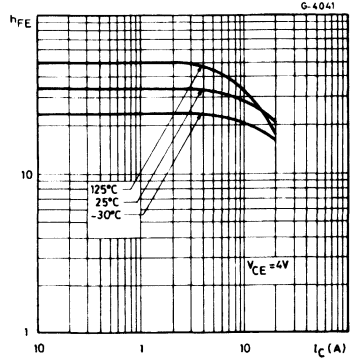

Collector-emitter Saturation Voltage.

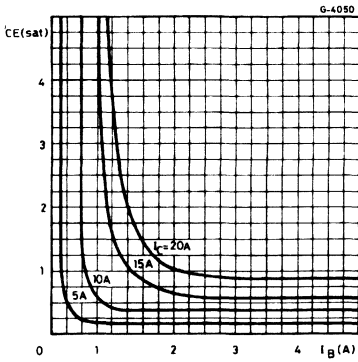

Collector-emitter Saturation Voltage.

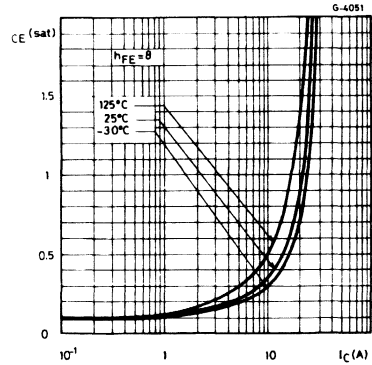

Base-emitter Saturation Voltage.

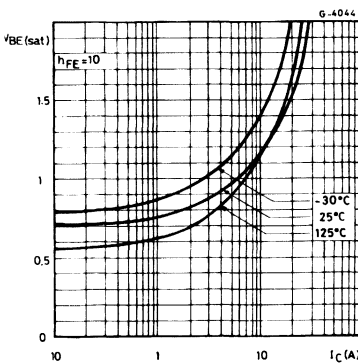

Saturated Switching Characteristics.

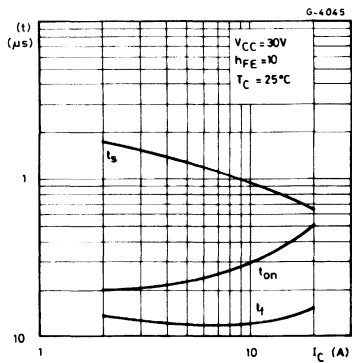

Saturated Switching Characteristics.

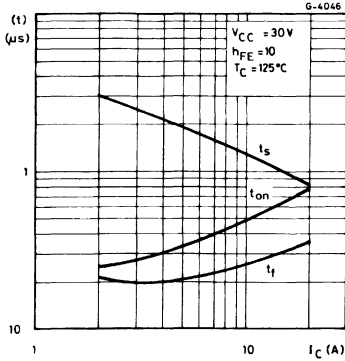

Transition Frequency.

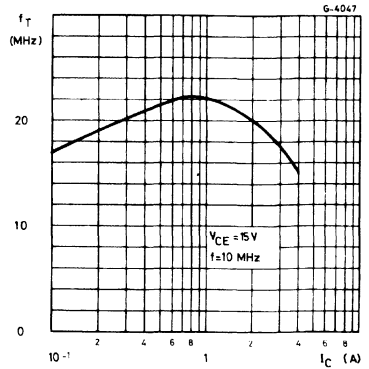

Collector-base Capacitance.

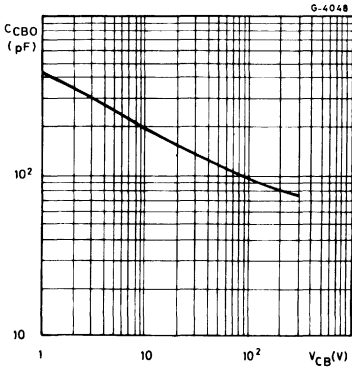

Clamped Reverse Bias Safe

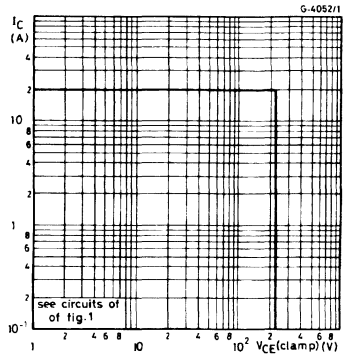
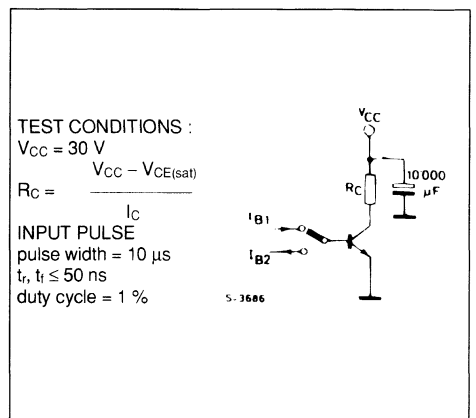
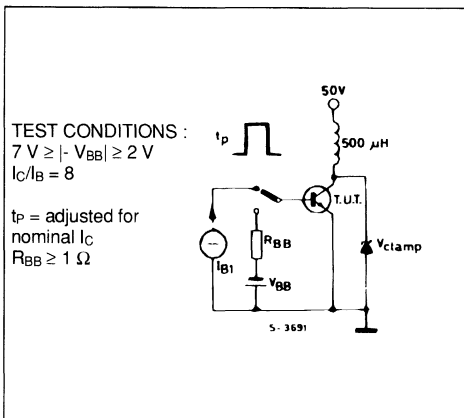

Figure 1 : Clamped E_{sb} Test Circuit.

Figure 2 : Switching Times Test Circuit (resistive load).



HIGH CURRENT, HIGH SPEED, HIGH POWER

DESCRIPTION

The BUX12 is a silicon multi-epitaxial planar NPN transistor in Jedec TO-3 metal case, intended for use in switching and linear applications in military and industrial equipment.

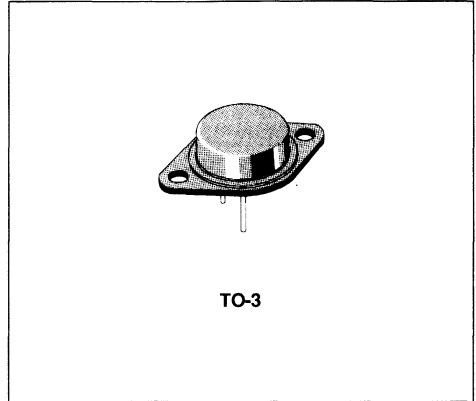
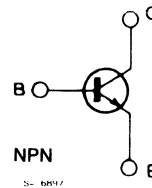
INTERNAL SCHEMATIC DIAGRAM

ABSOLUTE MAXIMUM RATINGS

Symbol	Parameter	Value	Unit
V_{CBO}	Collector-base Voltage ($I_E = 0$)	300	V
V_{CEX}	Collector-emitter Voltage ($V_{BE} = -1.5$ V)	300	V
V_{CEO}	Collector-emitter Voltage ($I_B = 0$)	250	V
V_{EBO}	Emitter-base Voltage ($I_C = 0$)	7	V
I_C	Collector Current	20	A
I_{CM}	Collector Peak Current ($t_p = 10$ ms)	25	A
I_B	Base Current	4	A
P_{Tot}	Total Power Dissipation at $T_{case} \leq 25$ °C	150	W
T_{stg}	Storage Temperature	- 65 to 200	°C
T_j	Junction Temperature	200	°C

THERMAL DATA

$R_{th\ j-case}$	Thermal Resistance Junction-case	Max	1.17	°C/W
------------------	----------------------------------	-----	------	------

ELECTRICAL CHARACTERISTICS ($T_{case} = 25\ ^\circ C$ unless otherwise specified)

Symbol	Parameter	Test Conditions	Min.	Typ.	Max.	Unit
I_{CEO}	Collector Cutoff Current ($I_B = 0$)	$V_{CE} = 200\ V$			1.5	mA
I_{CEX}	Collector Cutoff Current	$V_{CE} = 300\ V$ $V_{BE} = -1.5\ V$ $T_{case} = 125\ ^\circ C$ $V_{CE} = 300\ V$ $V_{BE} = -1.5\ V$			1.5 6	mA mA
I_{EBO}	Emitter Cutoff Current ($I_C = 0$)	$V_{EB} = 5\ V$			1	mA
$V_{CEO(sus)}^*$	Collector-emitter Sustaining Voltage	$I_C = 200\ mA$	250			V
V_{EBO}	Emitter-base Voltage ($I_C = 0$)	$I_E = 50\ mA$	7			V
$V_{CE(sat)}^*$	Collector-emitter Saturation Voltage	$I_C = 5\ A$ $I_B = 0.5\ A$ $I_C = 10\ A$ $I_B = 1.25\ A$		0.22 0.5	1 1.5	V V
$V_{BE(sat)}^*$	Base-emitter Saturation Voltage	$I_C = 10\ A$ $I_B = 1.25\ A$		1.23	1.5	V
h_{FE}^*	DC Current Gain	$I_C = 5\ A$ $V_{CE} = 4\ V$ $I_C = 10\ A$ $V_{CE} = 4\ V$	20 10		60	
$I_{s/b}$	Second Breakdown Collector Current	$V_{CE} = 30\ V$ $t = 1\ s$ $V_{CE} = 140\ V$ $t = 1\ s$	5 0.15			A A
f_T	Transition Frequency	$I_C = 1\ A$ $V_{CE} = 15\ V$ $f = 10\ MHz$	8			MHz
t_{on}	Turn-on Time (fig. 2)	$I_C = 10\ A$ $I_{B1} = 1.25\ A$ $V_{CC} = 150\ V$		0.28	1	μs
t_s	Storage Time (fig. 2)	$I_C = 10\ A$ $I_{B1} = 1.25\ A$		1.45	2	μs
t_f	Fall Time (fig. 2)	$I_{B2} = -1.25\ A$ $V_{CC} = 150\ V$		0.23	0.5	μs
	Clamped $E_{s/b}$ Collector Current (fig. 1)	$V_{clamp} = 250\ V$ $L = 500\ \mu H$	10			A

* Pulsed : pulse duration = 300 μs , duty cycle $\leq 2\ %$.

Safe Operating Areas.

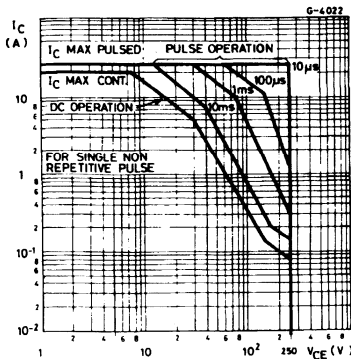

Derating Curves.

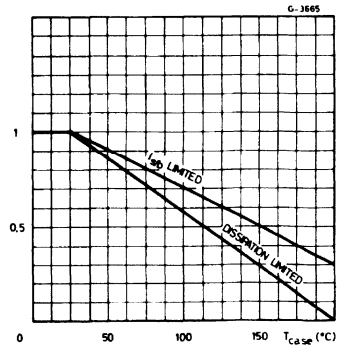

Thermal Transient Response.

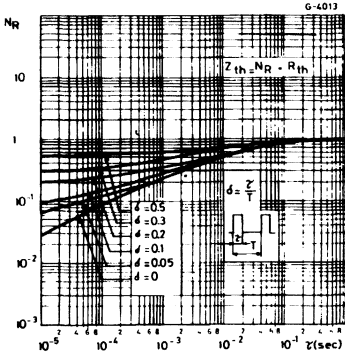

DC Current Gain.

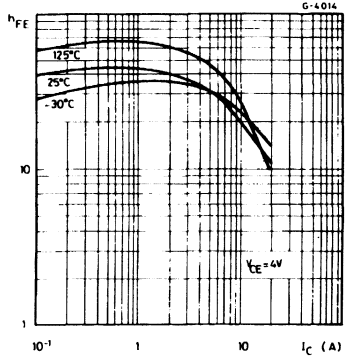

Collector-emitter Saturation Voltage.

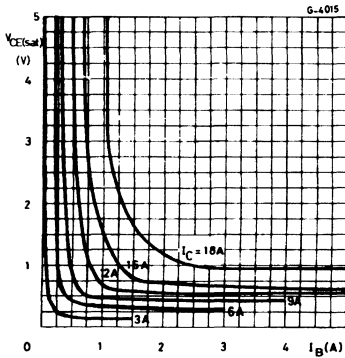

Collector-emitter Saturation Voltage.

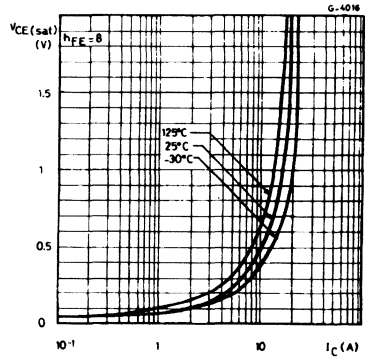

Base-emitter Saturation Voltage.

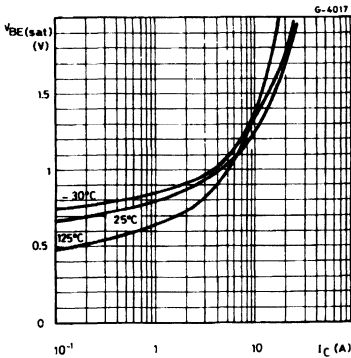

Saturated Switching Characteristics.

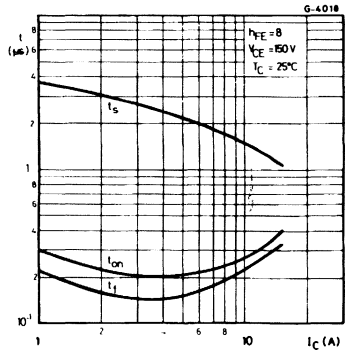

Saturated Switching Characteristics.

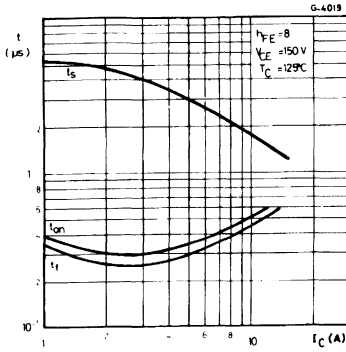

Collector-base Capacitance.

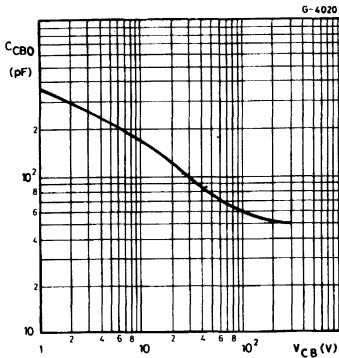
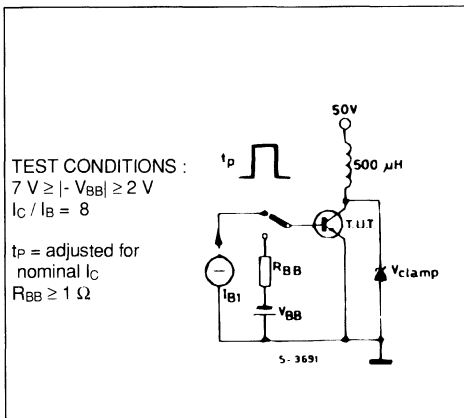
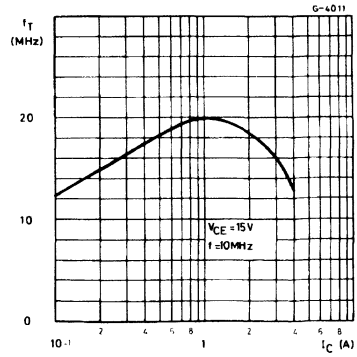

Figure 1 : Clamped $E_{s/b}$ Test Circuit.



Transition Frequency.



Clamped Reverse Bias Safe Operating Area.

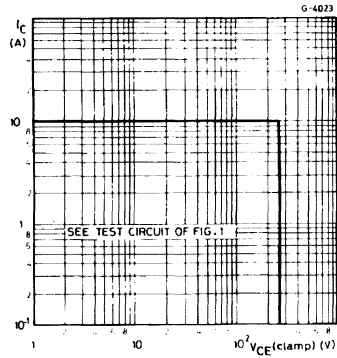
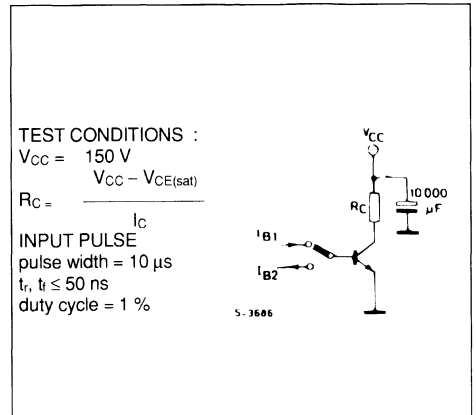

Figure 2 : Switching Times Test Circuit (resistive load).



HIGH VOLTAGE POWER SWITCH

DESCRIPTION

The BUX13 is a silicon multi-epitaxial mesa NPN transistor in Jedec TO-3 metal case, intended for high voltage, fast switching applications.

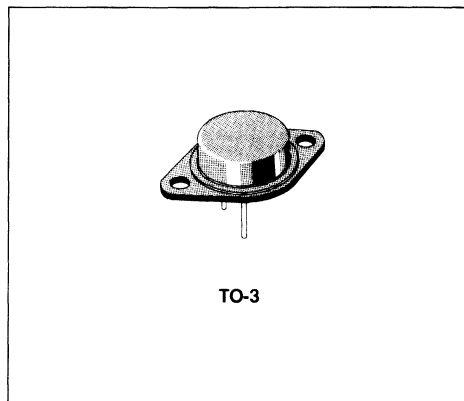

INTERNAL SCHEMATIC DIAGRAM

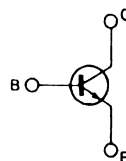

ABSOLUTE MAXIMUM RATINGS

Symbol	Parameter	Value	Unit
V_{CES}	Collector-emitter Voltage ($V_{BE} = 0$)	400	V
V_{CER}	Collector-emitter Voltage ($R_{BE} \leq 100 \Omega$)	390	V
V_{CEO}	Collector-emitter Voltage ($I_B = 0$)	325	V
V_{EBO}	Base-emitter Voltage ($I_C = 0$)	7	V
I_C	Collector Current	15	A
I_{CM}	Collector Peak Current ($t_p \leq 10$ ms)	20	A
I_B	Base Current	3	A
P_{tot}	Total Power Dissipation at $T_{case} \leq 25$ °C	150	W
T_{stg}	Storage Temperature	- 65 to 200	°C
T_j	Junction Temperature	200	°C

THERMAL DATA

$R_{th\ j-case}$	Thermal Resistance Junction-case	Max	1.17	°C/W
------------------	----------------------------------	-----	------	------

ELECTRICAL CHARACTERISTICS ($T_{case} = 25\text{ °C}$ unless otherwise specified)

Symbol	Parameter	Test Conditions	Min.	Typ.	Max.	Unit
I_{CES}	Collector Cutoff Current ($V_{BE} = 0$)	$V_{CE} = 400\text{ V}$ $V_{CE} = 400\text{ V}$ $T_{case} = 125\text{ °C}$			1.5 6	mA mA
I_{CEO}	Collector Cutoff Current ($I_B = 0$)	$V_{CE} = 260\text{ V}$			1.5	mA
I_{EBO}	Emitter Cutoff Current ($I_C = 0$)	$V_{EB} = 7\text{ V}$			1	mA
$V_{CEO(sus)}^*$	Collector-emitter Sustaining Voltage ($I_B = 0$)	$I_C = 100\text{ mA}$	325			V
$V_{CE(sat)}^*$	Collector-emitter Saturation Voltage	$I_C = 4\text{ A}$ $I_B = 0.8\text{ A}$ $I_C = 8\text{ A}$ $I_B = 1.6\text{ A}$			0.8 1.5	V V
$V_{BE(sat)}^*$	Base-emitter Saturation Voltage	$I_C = 8\text{ A}$ $I_B = 1.6\text{ A}$			1.5	V
h_{FE}^*	DC Current Gain	$I_C = 4\text{ A}$ $V_{CE} = 4\text{ V}$ $I_C = 8\text{ A}$ $V_{CE} = 4\text{ V}$	15 8		60	
f_T	Transition Frequency	$I_C = 1\text{ A}$ $V_{CE} = 15\text{ V}$ $f = 10\text{ MHz}$	8			MHz
t_{on}	Turn-on Time	$I_C = 8\text{ A}$ $I_{B1} = 1.6\text{ A}$ $V_{CC} = 150\text{ V}$			1.2	μs
t_s	Storage Time	$I_C = 8\text{ A}$ $I_{B1} = -I_{B2} = 1.6\text{ A}$			2.5	μs
t_f	Fall Time	$V_{CC} = 150\text{ V}$			1	μs

* Pulsed : pulse duration = 300μs, duty cycle ≤ 2%.

HIGH VOLTAGE POWER SWITCH

DESCRIPTION

The BUX14 is a silicon multi-epitaxial mesa NPN transistor in Jedec TO-3 metal case, intended for high voltage, fast switching applications.

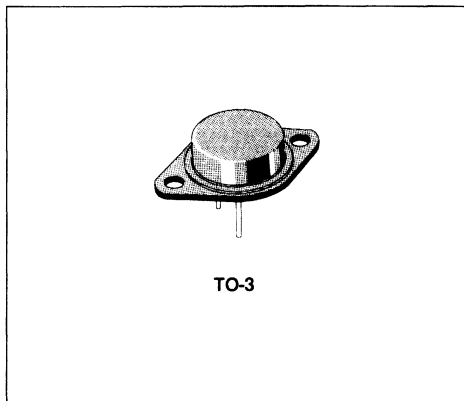

INTERNAL SCHEMATIC DIAGRAM

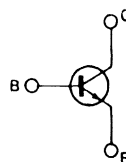

ABSOLUTE MAXIMUM RATINGS

Symbol	Parameter	Value	Unit
V_{CES}	Collector-emitter Voltage ($V_{BE} = 0$)	450	V
V_{CER}	Collector-emitter Voltage ($R_{BE} \leq 100 \Omega$)	440	V
V_{CEO}	Collector-emitter Voltage ($I_B = 0$)	400	V
V_{EBO}	Base-emitter Voltage ($I_C = 0$)	7	V
I_C	Collector Current	10	A
I_{CM}	Collector Peak Current ($t_p \leq 10$ ms)	15	A
I_B	Base Current	2	A
P_{tot}	Total Power Dissipation at $T_{case} \leq 25^\circ C$	150	W
T_{stg}	Storage Temperature	- 65 to 200	$^\circ C$
T_j	Junction Temperature	200	$^\circ C$

THERMAL DATA

$R_{th \text{ J-case}}$	Thermal Resistance Junction-case	Max	1.17	°C/W
-------------------------	----------------------------------	-----	------	------

ELECTRICAL CHARACTERISTICS ($T_{case} = 25 \text{ °C}$ unless otherwise specified)

Symbol	Parameter	Test Conditions	Min.	Typ.	Max.	Unit
I_{CES}	Collector Cutoff Current ($V_{BE} = 0$)	$V_{CE} = 450 \text{ V}$ $V_{CE} = 450 \text{ V}$ $T_{case} = 125 \text{ °C}$			1.5 6	mA mA
I_{CEO}	Collector Cutoff Current ($I_B = 0$)	$V_{CE} = 320 \text{ V}$			1.5	mA
I_{EBO}	Emitter Cutoff Current ($I_C = 0$)	$V_{EB} = 7 \text{ V}$			1	mA
$V_{CEO(sus)}^*$	Collector-emitter Sustaining Voltage ($I_B = 0$)	$I_C = 100 \text{ mA}$	400			V
$V_{CE(sat)}^*$	Collector-emitter Saturation Voltage	$I_C = 3 \text{ A}$ $I_B = 0.6 \text{ A}$ $I_C = 6 \text{ A}$ $I_B = 1.2 \text{ A}$			0.6 1.5	V V
$V_{BE(sat)}^*$	Base-emitter Saturation Voltage	$I_C = 6 \text{ A}$ $I_B = 1.2 \text{ A}$			1.5	V
h_{FE}^*	DC Current Gain	$I_C = 3 \text{ A}$ $V_{CE} = 4 \text{ V}$ $I_C = 6 \text{ A}$ $V_{CE} = 4 \text{ V}$	15 8		60	
f_T	Transition Frequency	$I_C = 1 \text{ A}$ $V_{CE} = 15 \text{ V}$ $f = 10 \text{ MHz}$	8			MHz
t_{on}	Turn-on Time	$I_C = 6 \text{ A}$ $I_{B1} = 1.2 \text{ A}$ $V_{CC} = 150 \text{ V}$			1.4	μs
t_s	Storage Time	$I_C = 6 \text{ A}$ $I_{B1} = -I_{B2} = 1.2 \text{ A}$ $V_{CC} = 150 \text{ V}$			3	μs
t_f	Fall Time				1.2	μs

* Pulsed : pulse duration = 300 μs, duty cycle ≤ 2 %.

HIGH CURRENT, HIGH SPEED, HIGH POWER TRANSISTOR

DESCRIPTION

The BUX20 is a silicon multi-epitaxial planar NPN transistor in modified Jedec TO-3 metal case, intended for use in switching and linear applications in military and industrial equipment.

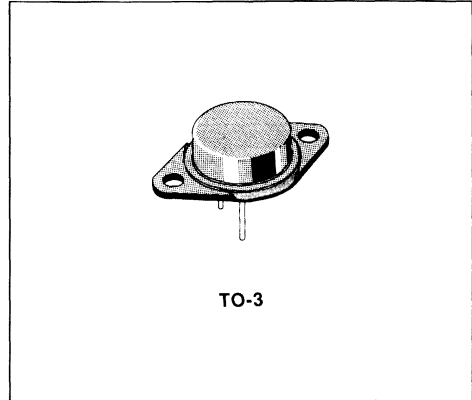

INTERNAL SCHEMATIC DIAGRAM

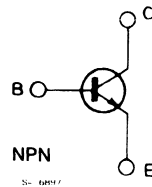

ABSOLUTE MAXIMUM RATINGS

Symbol	Parameter	Value	Unit
V_{CBO}	Collector-base Voltage ($I_E = 0$)	160	V
V_{CEX}	Collector-emitter Voltage ($V_{BE} = -1.5$ V)	160	V
V_{CEO}	Collector-emitter Voltage ($I_B = 0$)	125	V
V_{EBO}	Emitter-base Voltage ($I_C = 0$)	7	V
I_C	Collector Current	50	A
I_{CM}	Collector Peak Current ($t_p = 10$ ms)	60	A
I_B	Base Current	10	A
P_{tot}	Total Power Dissipation at $T_{case} \leq 25$ °C	350	W
T_{stg}	Storage Temperature	- 65 to 200	°C
T_j	Junction Temperature	200	°C

THERMAL DATA

$R_{th\ j-case}$	Thermal Resistance Junction-case	Max	0.5	°C/W
------------------	----------------------------------	-----	-----	------

ELECTRICAL CHARACTERISTICS ($T_{case} = 25\text{ °C}$ unless otherwise specified)

Symbol	Parameter	Test Conditions	Min.	Typ.	Max.	Unit
I_{CEO}	Collector Cutoff Current ($I_B = 0$)	$V_{CE} = 100\text{ V}$			3	mA
I_{CEX}	Collector Cutoff Current	$V_{CE} = 160\text{ V}$ $V_{BE} = -1.5\text{ V}$ $T_{case} = 125\text{ °C}$ $V_{BE} = -1.5\text{ V}$ $V_{CE} = 160\text{ V}$			3 12	mA mA
I_{EBO}	Emitter Cutoff Current ($I_C = 0$)	$V_{EB} = 5\text{ V}$			1	mA
$V_{CEO(sus)}^*$	Collector-emitter Sustaining Voltage	$I_C = 200\text{ mA}$	125			V
V_{EBO}	Emitter-base Voltage ($I_C = 0$)	$I_E = 50\text{ mA}$	7			V
$V_{CE(sat)}^*$	Collector-emitter Saturation Voltage	$I_C = 25\text{ A}$ $I_B = 2.5\text{ A}$ $I_C = 50\text{ A}$ $I_B = 5\text{ A}$		0.3 0.55	0.6 1.2	V V
$V_{BE(sat)}^*$	Base-emitter Saturation Voltage	$I_C = 50\text{ A}$ $I_B = 5\text{ A}$		1.35	2	V
h_{FE}^*	DC Current Gain	$I_C = 25\text{ A}$ $V_{CE} = 2\text{ V}$ $I_C = 50\text{ A}$ $V_{CE} = 4\text{ V}$	20 10		60	
$I_{s/b}$	Second Breakdown Collector Current	$V_{CE} = 40\text{ V}$ $t = 1\text{ s}$ $V_{CE} = 20\text{ V}$ $t = 1\text{ s}$	1.5 17.5			A A
f_T	Transition Frequency	$V_{CE} = 15\text{ V}$ $I_C = 2\text{ A}$ $f = 10\text{ MHz}$	8			MHz
t_{on}	Turn-on Time (fig. 2)	$I_C = 50\text{ A}$ $I_{B1} = 5\text{ A}$ $V_{CC} = 60\text{ V}$		0.4	1.5	μs
t_s	Storage Time (fig. 2)	$I_C = 50\text{ A}$ $I_{B1} = 5\text{ A}$		0.85	1.2	μs
t_f	Fall Time (fig. 2)	$I_{B2} = -5\text{ A}$ $V_{CC} = 60\text{ V}$		0.1	0.3	μs
	Clamped $E_{s/b}$ Collector Current (fig. 1)	$V_{clamp} = 125\text{ V}$ $L = 500\text{ }\mu\text{H}$	50			A

* Pulsed : pulse duration = 300 μs , duty cycle $\leq 2\%$.

Safe Operating Areas.

Derating Curves.

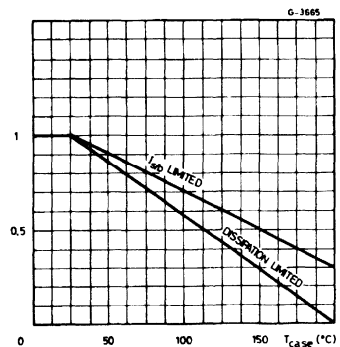
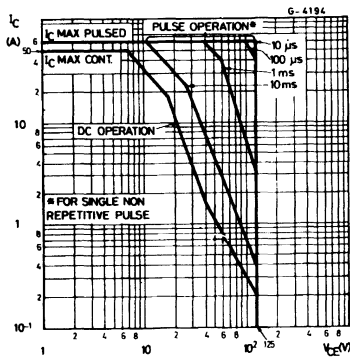

Thermal Transient Response.

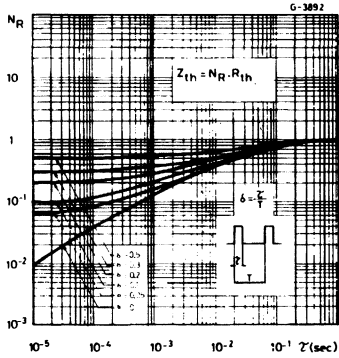

Collector-emitter Saturation Voltage.

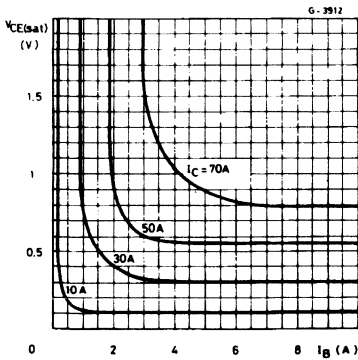

Base-emitter Saturation Voltage.

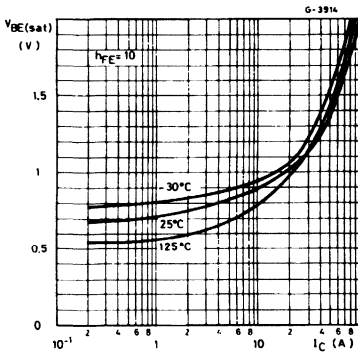

DC Current Gain.

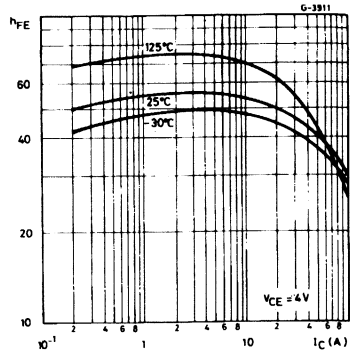

Collector-emitter Saturation Voltage.

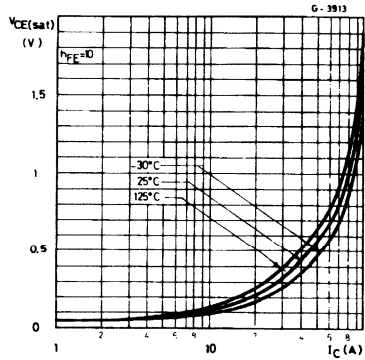

Saturated Switching Characteristics.

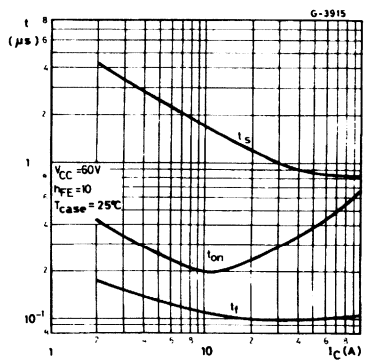

Saturated Switching Characteristics.

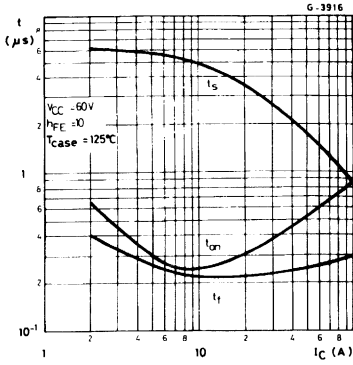

Collector-base Capacitance.

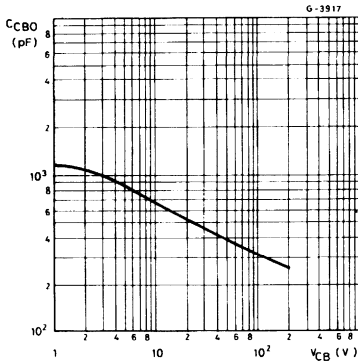
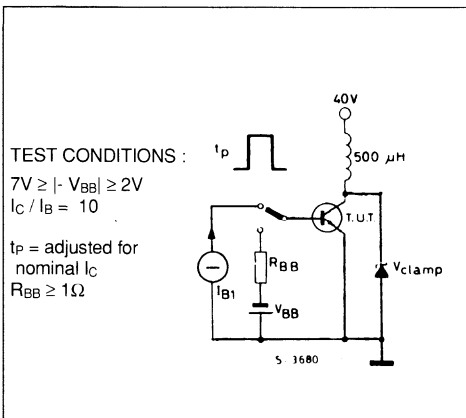
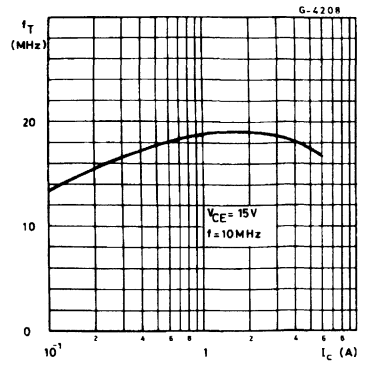

Figure 1 : Clamped $E_{S/b}$ Test Circuit.



Transition Frequency.



Clamped Reverse Bias Safe Operating Area.

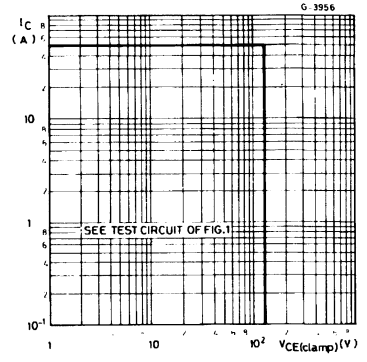
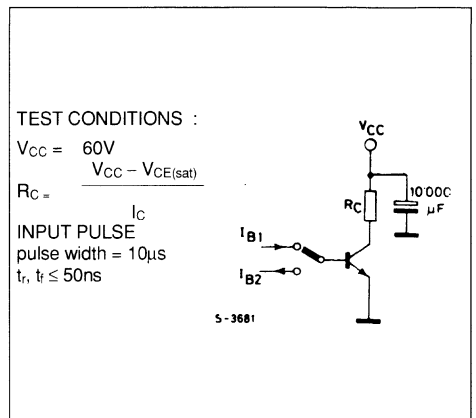

Figure 2 : Switching Times Test Circuit (resistive load).



HIGH CURRENT, HIGH SPEED, HIGH POWER TRANSISTOR

DESCRIPTION

The BUX21 is a silicon multi-epitaxial planar NPN transistor in modified Jecdec TO-3 metal case, intended for use in switching and linear applications in military and industrial equipment.

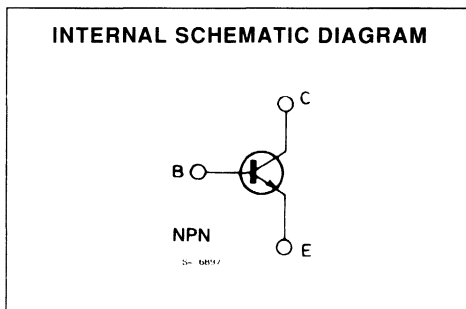
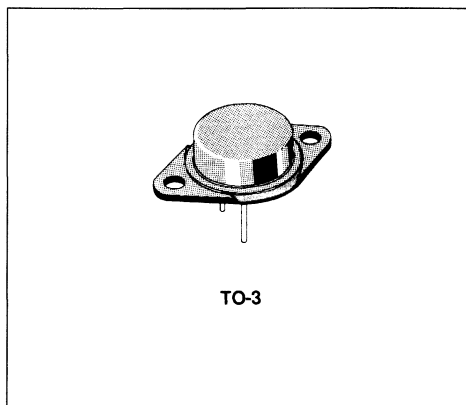

ABSOLUTE MAXIMUM RATINGS

Symbol	Parameter	Value	Unit
V_{CBO}	Collector-base Voltage ($I_E = 0$)	250	V
V_{CEX}	Collector-emitter Voltage ($V_{BE} = -1.5$ V)	250	V
V_{CEO}	Collector-emitter Voltage ($I_B = 0$)	200	V
V_{EBO}	Emitter-base Voltage ($I_C = 0$)	7	V
I_C	Collector Current	40	A
I_{CM}	Collector Peak Current ($t_p = 10$ ms)	50	A
I_B	Base Current	8	A
P_{tot}	Total Power Dissipation at $T_{case} \leq 25$ °C	350	W
T_{stg}	Storage Temperature	- 65 to 200	°C
T_j	Junction Temperature	200	°C

THERMAL DATA

$R_{th J-case}$	Thermal Resistance Junction-case	Max	0.5	°C/W
-----------------	----------------------------------	-----	-----	------

ELECTRICAL CHARACTERISTICS ($T_{case} = 25\text{ °C}$ unless otherwise specified)

Symbol	Parameter	Test Conditions	Min.	Typ.	Max.	Unit
I_{CEO}	Collector Cutoff Current ($I_B = 0$)	$V_{CE} = 160\text{ V}$			3	mA
I_{CEX}	Collector Cutoff Current	$V_{CE} = 250\text{ V}$ $V_{BE} = -1.5\text{ V}$			3	mA
		$T_{case} = 125\text{ °C}$ $V_{CE} = 250\text{ V}$ $V_{BE} = -1.5\text{ V}$			12	mA
I_{EBO}	Emitter Cutoff Current ($I_C = 0$)	$V_{EB} = 5\text{ V}$			1	mA
$V_{CEO(sus)*}$	Collector-emitter Sustaining Voltage	$I_C = 200\text{ mA}$	200			V
V_{EBO}	Emitter-base Voltage ($I_C = 0$)	$I_E = 50\text{ mA}$	7			V
$V_{CE(sat)*}$	Collector-emitter Saturation Voltage	$I_C = 12\text{ A}$ $I_B = 1.2\text{ A}$		0.22	0.6	V
		$I_C = 25\text{ A}$ $I_B = 3\text{ A}$		0.4	1.5	V
$V_{BE(sat)*}$	Base-emitter Saturation Voltage	$I_C = 25\text{ A}$ $I_B = 3\text{ A}$		1.2	1.5	V
h_{FE}^*	DC Current Gain	$I_C = 12$ $V_{CE} = 2\text{ V}$	20		60	
		$I_C = 25$ $V_{CE} = 4\text{ V}$	10			
$I_{s/b}$	Second Breakdown Collector Current	$V_{CE} = 140\text{ V}$ $t = 1\text{ s}$	0.15			A
		$V_{CE} = 20\text{ V}$ $t = 1\text{ s}$	17.5			A
f_T	Transition Frequency	$V_{CE} = 15\text{ V}$ $f = 10\text{ MHz}$ $I_C = 2\text{ A}$	8			MHz
t_{on}	Turn-on Time (fig. 2)	$I_C = 25\text{ A}$ $V_{CC} = 100\text{ V}$ $I_{B1} = 3\text{ A}$		0.24	1.2	μs
t_s	Storage Time (fig. 2)	$I_C = 25\text{ A}$ $I_{B1} = 3\text{ A}$ $I_{B2} = -3\text{ A}$ $V_{CC} = 100\text{ V}$		1.3	1.8	μs
t_f	Fall Time (fig. 2)			0.18	0.4	μs
	Clamped $E_{s/b}$ Collector Current (fig. 1)	$V_{clamp} = 200\text{ V}$ $L = 500\text{ μH}$	30			A

* Pulsed : pulse duration = 300μs, duty cycle ≤ 2%.

Safe Operating Areas.

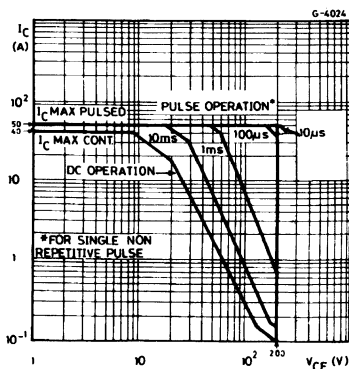

Derating Curves.

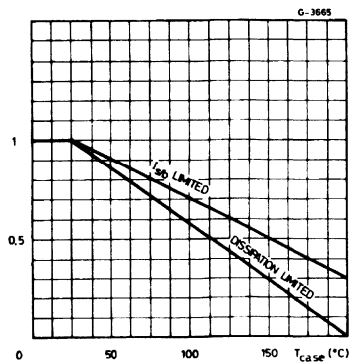

Thermal Transient Response.

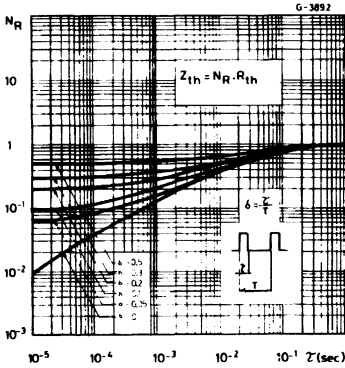

DC Current Gain.

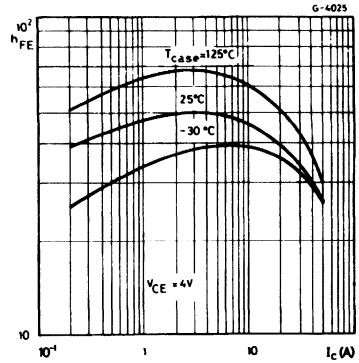

Collector-emitter Saturation Voltage.

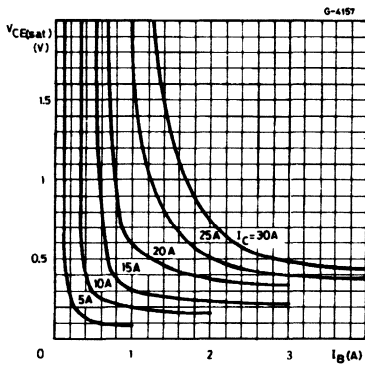

Collector-emitter Saturation Voltage.

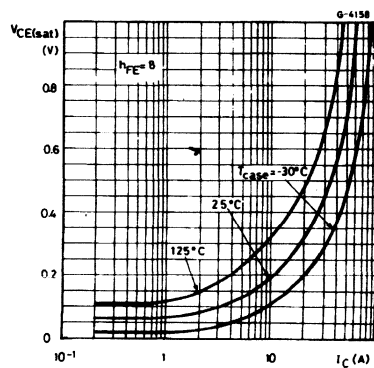

Base-emitter Saturation Voltage.

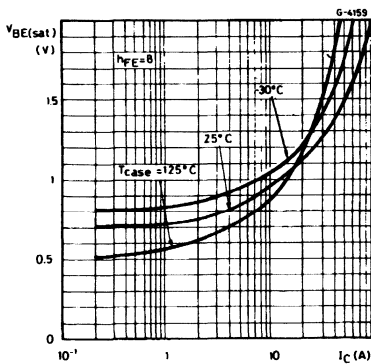

Saturated Switching Characteristics.

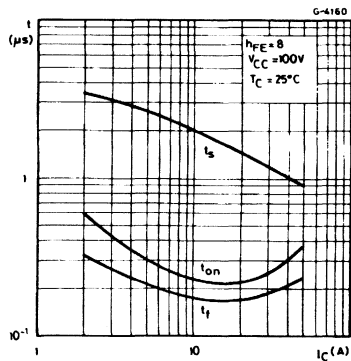

Saturated Switching Characteristics.

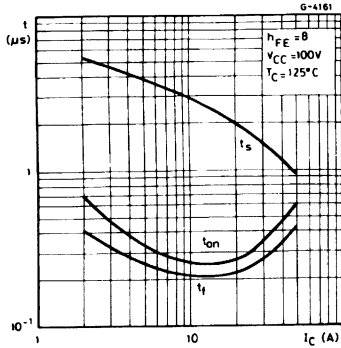

Transition Frequency.

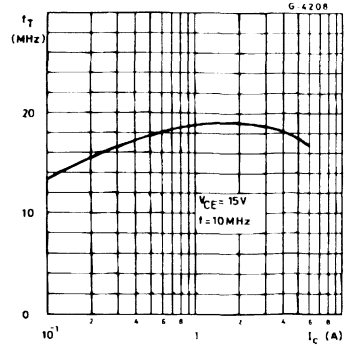

Collector-base Capacitance.

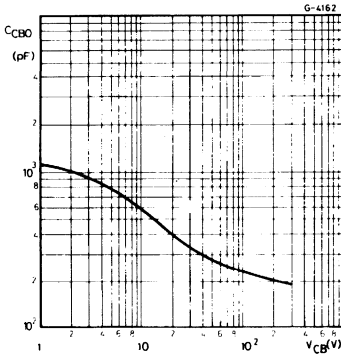

Clamped Reverse Bias Safe Operating Area.

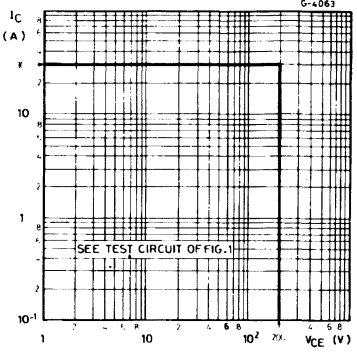
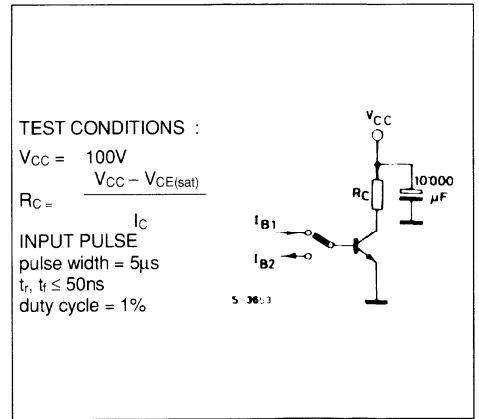
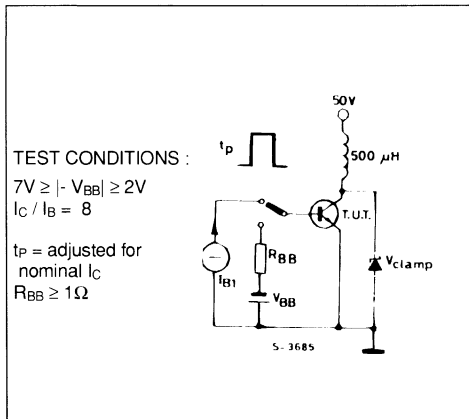

Figure 1 : Clamped E_{s/b} Test Circuit.

Figure 2 : Switching Times Test Circuit (resistive load).



HIGH CURRENT, HIGH SPEED, HIGH POWER TRANSISTOR

DESCRIPTION

The BUX22 is a silicon multiepitaxial planar NPN transistor in modified Jedec TO-3 metal case, intended for use in switching and linear applications in military and industrial equipment.

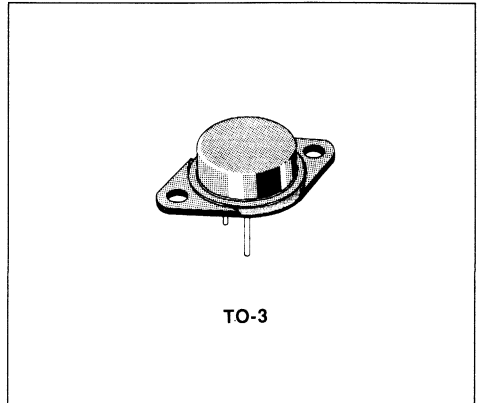

INTERNAL SCHEMATIC DIAGRAM

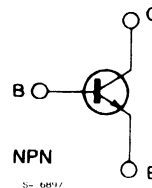

ABSOLUTE MAXIMUM RATINGS

Symbol	Parameter	Value	Unit
V_{CBO}	Collector-base Voltage ($I_E = 0$)	300	V
V_{CEX}	Collector-emitter Voltage ($V_{BE} = -1.5$ V)	300	V
V_{CEO}	Collector-emitter Voltage ($I_B = 0$)	250	V
V_{EBO}	Emitter-base Voltage ($I_C = 0$)	7	V
I_C	Collector Current	40	A
I_{CM}	Collector Peak Current ($t_p = 10$ ms)	50	A
I_B	Base Current	8	A
P_{tot}	Total Power Dissipation at $T_{case} \leq 25$ °C	350	W
T_{stg}	Storage Temperature	- 65 to 200	°C
T_j	Junction Temperature	200	°C

THERMAL DATA

$R_{th\ j-case}$	Thermal Resistance Junction-case	Max	0.5	°C/W
------------------	----------------------------------	-----	-----	------

ELECTRICAL CHARACTERISTICS ($T_{case} = 25\text{ °C}$ unless otherwise specified)

Symbol	Parameter	Test Conditions	Min.	Typ.	Max.	Unit
I_{CEO}	Collector Cutoff Current ($I_B = 0$)	$V_{CE} = 200\text{ V}$			3	mA
I_{CEX}	Collector Cutoff Current	$V_{CE} = 300\text{ V}$ $V_{BE} = -1.5\text{ V}$ $T_{case} = 125\text{ °C}$ $V_{CE} = 300\text{ V}$ $V_{BE} = -1.5\text{ V}$			3 12	mA mA
I_{EBO}	Emitter Cutoff Current ($I_C = 0$)	$V_{EB} = 5\text{ V}$			1	mA
$V_{CEO(sus)}^*$	Collector-emitter Sustaining Voltage	$I_C = 200\text{ mA}$	250			V
V_{EBO}	Emitter-base Voltage ($I_C = 0$)	$I_E = 50\text{ mA}$	7			V
$V_{CE(sat)}^*$	Collector-emitter Saturation Voltage	$I_C = 10\text{ A}$ $I_B = 1\text{ A}$ $I_C = 20\text{ A}$ $I_B = 2.5\text{ A}$		0.2 0.32	1 1.5	V V
$V_{BE(sat)}^*$	Base-emitter Saturation Voltage	$I_C = 20\text{ A}$ $I_B = 2.5\text{ A}$		1.1	1.5	V
h_{FE}^*	DC Current Gain	$I_C = 10\text{ A}$ $V_{CE} = 4\text{ V}$ $I_C = 20\text{ A}$ $V_{CE} = 4\text{ V}$	20 10		60	
$I_{s/b}$	Second Breakdown Collector Current	$V_{CE} = 140\text{ V}$ $t = 1\text{ s}$ $V_{CE} = 20\text{ V}$ $t = 1\text{ s}$	0.15 17.5			A A
f_T	Transition Frequency	$I_C = 2\text{ A}$ $V_{CE} = 15\text{ V}$ $f = 10\text{ MHz}$	10			MHz
t_{on}	Turn-on Time (fig. 2)	$I_C = 20\text{ A}$ $I_{B1} = 2.5\text{ A}$ $V_{CC} = 100\text{ V}$		0.22	1.3	μs
t_s	Storage Time (fig. 2)	$I_C = 20\text{ A}$ $I_{B1} = 2.5\text{ A}$ $I_{B2} = -2.5\text{ A}$ $V_{CC} = 100\text{ V}$		1.5	2	μs
t_f	Fall Time (fig. 2)			0.17	0.5	μs
	Clamped $E_{s/b}$ Collector Current (fig. 1)	$V_{clamp} = 250\text{ V}$ $L = 500\text{ μH}$	25			A

* Pulsed : pulse duration = 300 μs, duty cycle ≤ 2 %.

Safe Operating Areas.

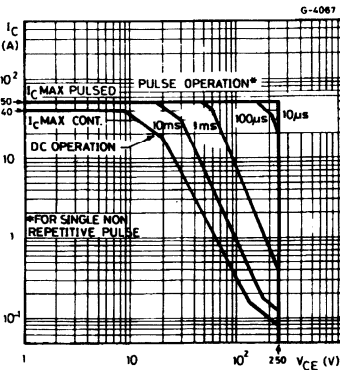

Derating Curves.

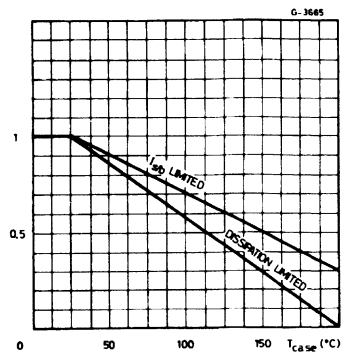

Thermal Transient Response.

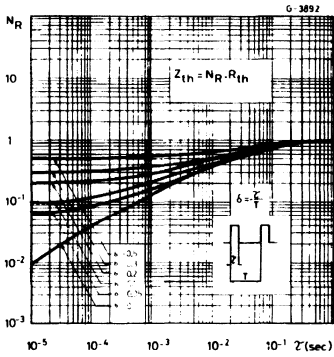

DC Current Gain.

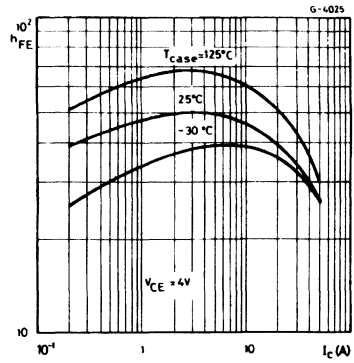

Collector-emitter Saturation Voltage.

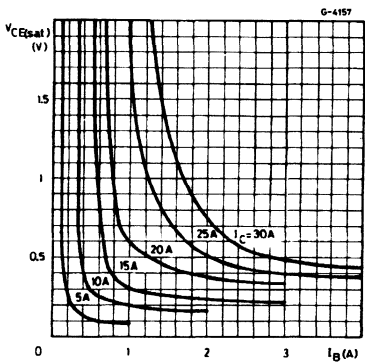

Collector-emitter Saturation Voltage.

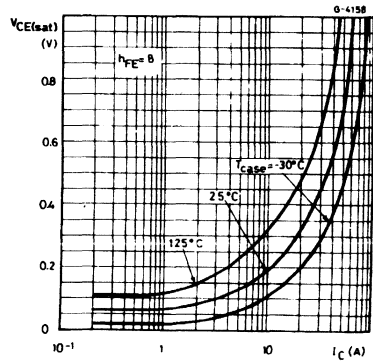

Base-emitter Saturation Voltage.

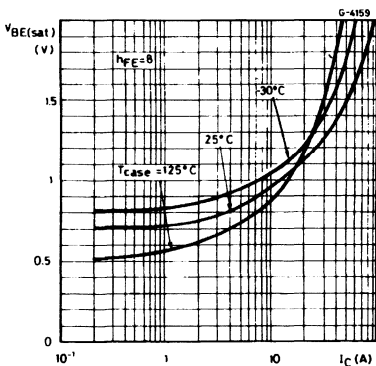

Saturated Switching Characteristics.

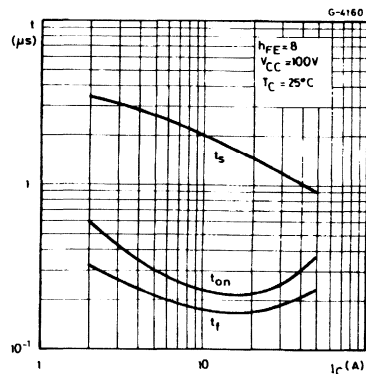

Saturated Switching Characteristics.

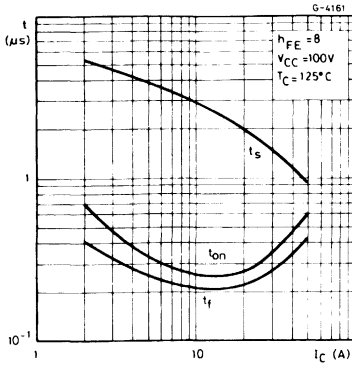

Transition Frequency.

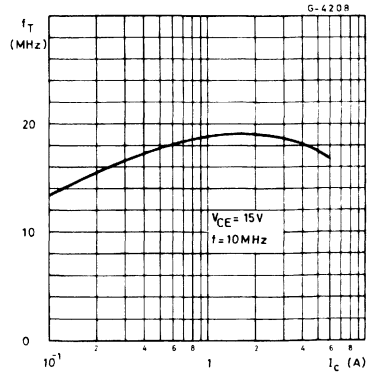

Collector-base Capacitance.

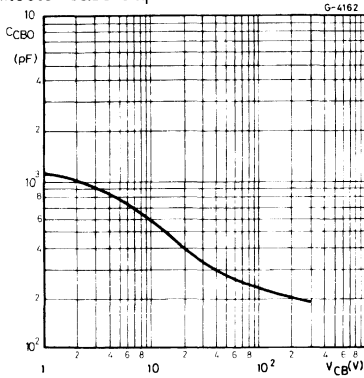

Clamped Reverse Bias Safe Operating Areas.

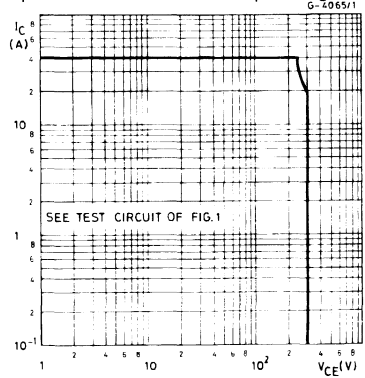
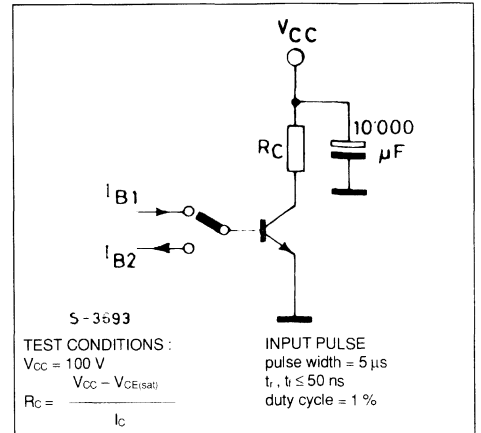
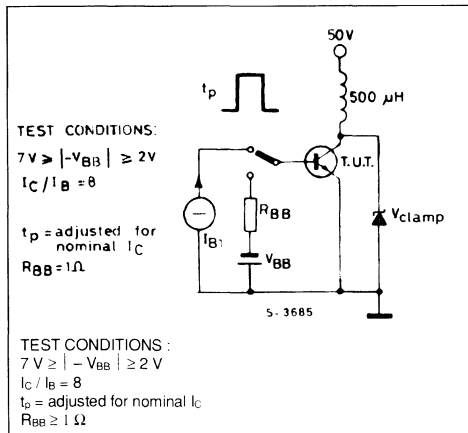

Figure 1 : Clamped $E_{S/b}$ Test Circuit.

Figure 2 : Switching Times Test Circuit (resistive load).



NPN SILICON TRANSISTOR

DESCRIPTION

High speed, high current, high power NPN transistor intended for use in switching and amplifier applications.

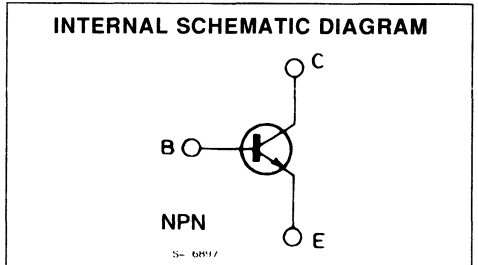
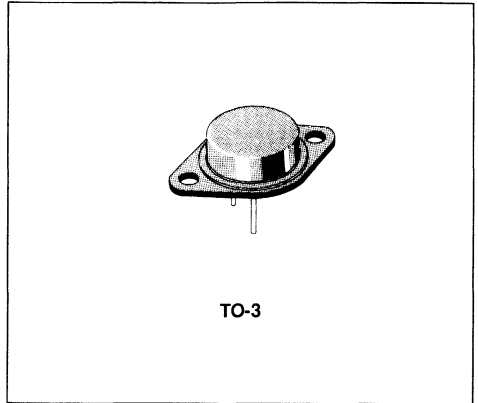

ABSOLUTE MAXIMUM RATINGS

Symbol	Parameter	Value	Unit
V_{CBO}	Collector-base Voltage ($I_E = 0$)	400	V
V_{CER}	Collector-emitter Voltage	390	V
V_{CEX}	Collector-emitter Voltage	400	V
V_{CEO}	Collector-emitter Voltage ($I_B = 0$)	325	V
V_{EBO}	Emitter-base Voltage ($I_C = 0$)	7	V
I_C	Collector Current	30	A
I_{CM}	Collector Peak Current ($t_p < 10ms$)	40	A
I_B	Base Current	6	A
P_{tot}	Total Dissipation at $T_C < 25^\circ C$	350	W
T_{stg}	Storage Temperature	- 65 to 200	$^\circ C$
T_j	Max. Operating Junction Temperature	200	$^\circ C$

THERMAL DATA

$R_{thj-case}$	Thermal Resistance Junction-case	Max	0.5	°C/W
----------------	----------------------------------	-----	-----	------

ELECTRICAL CHARACTERISTICS($T_{case} = 25^{\circ}C$ unless otherwise specified)

Symbol	Parameter	Test Conditions	Min.	Typ.	Max.	Unit
I_{CEX}	Collector Cutoff Current	$V_{CE} = 400V$ $V_{BE} = -1.5V$ $V_{CE} = 400V$ $V_{BE} = -1.5V$ $T_c = 125^{\circ}C$			3 12	mA mA
I_{CEO}	Collector Cutoff Current ($I_B = 0$)	$V_{CE} = 260V$			3	mA
I_{EBO}	Emitter Cutoff Current ($I_C = 0$)	$V_{EB} = 5V$			1	mA
$V_{CE0(sus)}^*$	Collector Emitter Sustaining Voltage	$I_C = 200mA$ $L = 25mH$	325			V
V_{EBO}	Emitter-base Voltage ($I_C = 0$)	$I_E = 50mA$	7			V
$V_{CE(sat)}^*$	Collector-emitter Saturation Voltage	$I_C = 8A$ $I_B = 1.6A$ $I_C = 16A$ $I_B = 3.2A$		0.2 0.35	0.8 1	V V
$V_{BE(sat)}^*$	Base-emitter Saturation Voltage	$I_C = 16A$ $I_B = 3.2A$		1.15	1.5	V
h_{FE}^*	DC Current Gain	$I_C = 8A$ $V_{CE} = 4V$ $I_C = 16A$ $V_{CE} = 4V$	15 8		60	
$I_{S/B}$	Second Breakdown Collector Current	$V_{CE} = 140V$ $t = 1s$ $V_{CE} = 16V$ $t = 1s$	0.15 22			A A
f_T	Transition Frequency	$I_C = 2A$ $V_{CE} = 15V$ $f = 10MHz$	8			MHz
t_{on}	Turn-on Time	$I_C = 16A$ $I_B = 3.2A$		0.55	1.3	μs
t_s t_f	Storage Time Fall Time	$I_C = 16A$ $I_{B1} = -I_{B2} = 3.2A$		1.7 0.26	2.5 1.2	μs μs

* Pulsed : Pulse duration = 300 μs , duty cycle = 1.5%.

TEST CIRCUIT

Figure 1: $V_{CE0(sus)}$.

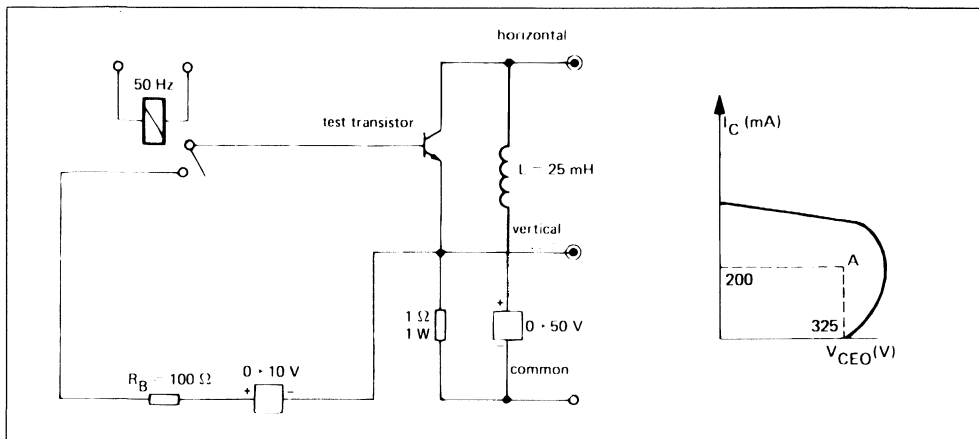

Note : The sustaining voltage V_{CE0} is acceptable when the trace falls to the right and above point "A".

SWITCHING TIMES TEST CIRCUITS (and oscillograms)

Figure 2.

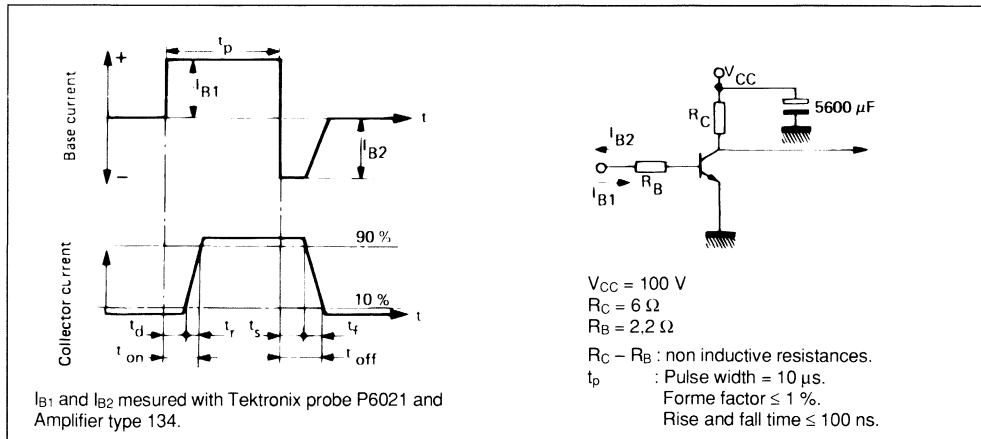

Safe Operating Area.

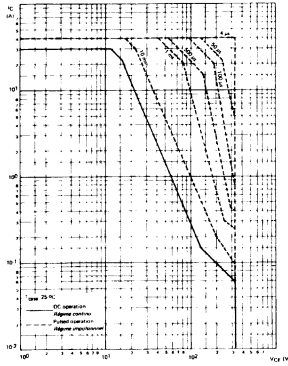

Derating and $I_{S/B}$ Derating.

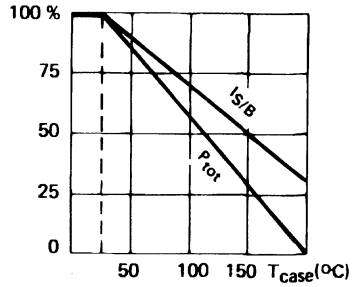

Collector Current versus Collector-emitter Voltage.

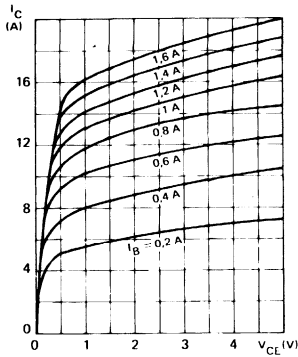

Collector Current versus Collector-emitter Voltage.

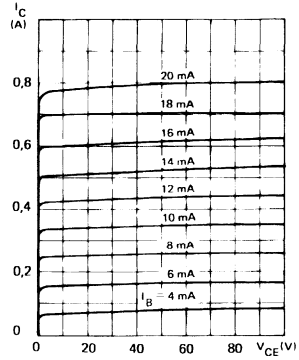

Collector Emitter Voltage versus Base-emitter Resistance (minimum value).

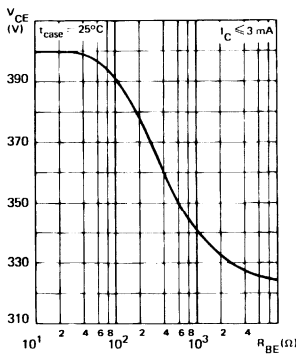

Static forward Current Transfer Ratio versus Collector Current.

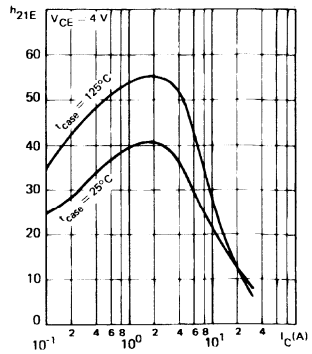

Base Current versus Base-emitter Voltage.

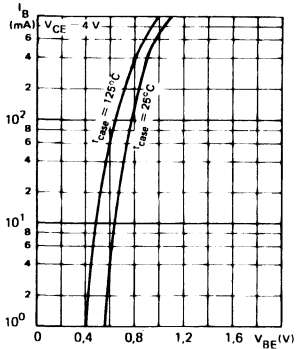

Collector Current versus Base-emitter Voltage.

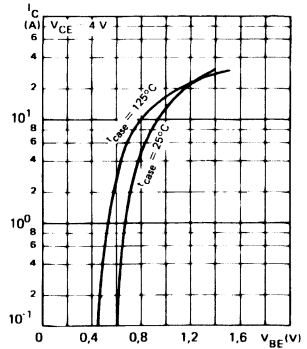

Collector-emitter Saturation Voltage versus Collector Current.

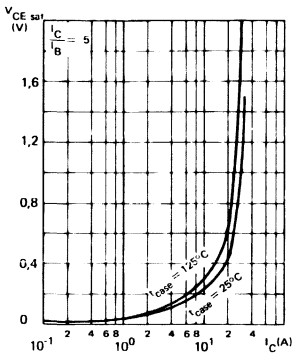

Base-emitter Saturation Voltage versus Collector Current.

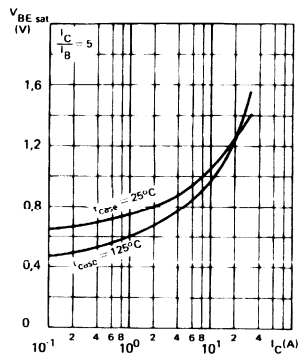

Output Capacitance versus Collector-base Voltage.

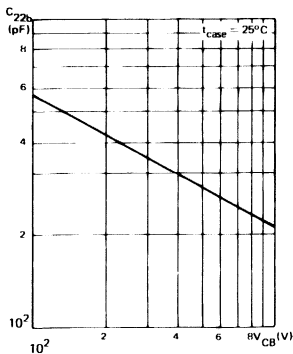

Transition Frequency versus Collector Current.

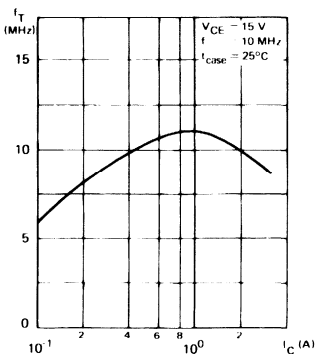

transient Thermal Resistance Derating Factor under Pulses Conditions.

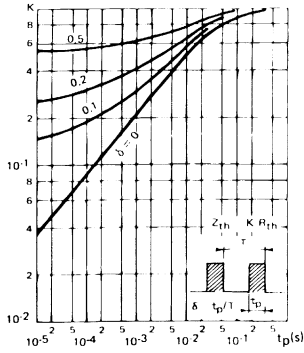

Switching Times versus Collector Current.

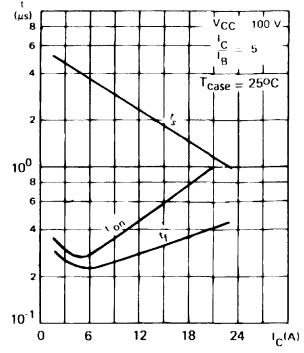

NPN SILICON TRANSISTOR

DESCRIPTION

High speed, high current, high power NPN transistor intended for use in switching and amplifier applications.

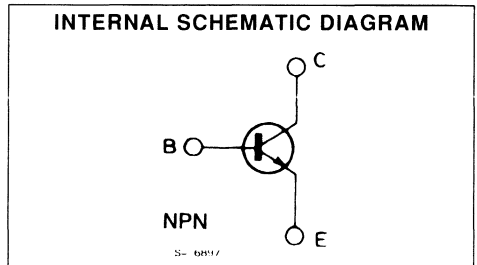
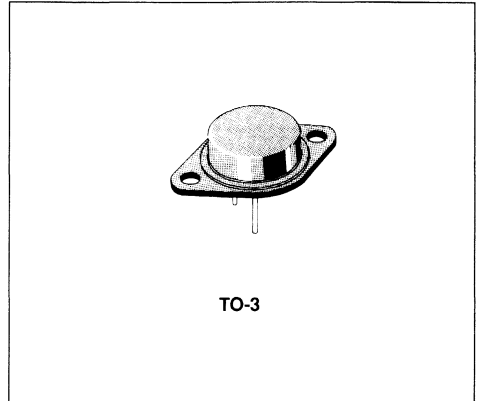

ABSOLUTE MAXIMUM RATINGS

Symbol	Parameter	Value	Unit
V_{CBO}	Collector-base Voltage ($I_E = 0$)	450	V
V_{CER}	Collector-emitter Voltage	440	V
V_{CEX}	Collector-emitter Voltage	450	V
V_{CEO}	Collector-emitter Voltage ($I_B = 0$)	400	V
V_{EBO}	Emitter-base Voltage ($I_C = 0$)	7	V
I_C	Collector Current	20	A
I_{CM}	Collector Peak Current ($t_p < 10ms$)	30	A
I_B	Base Current	4	A
P_{tot}	Total Dissipation at $T_c < 25^\circ C$	350	W
T_{stg}	Storage Temperature	- 65 to 200	$^\circ C$
T_j	Max. Operating Junction Temperature	200	$^\circ C$

THERMAL DATA

$R_{thj-case}$	Thermal Resistance Junction-case	Max	0.5	$^{\circ}C/W$
----------------	----------------------------------	-----	-----	---------------

ELECTRICAL CHARACTERISTICS ($T_{case} = 25^{\circ}C$ unless otherwise specified)

Symbol	Parameter	Test Conditions	Min.	Typ.	Max.	Unit
I_{CEX}	Collector Cutoff Current	$V_{CE} = 450V$ $V_{BE} = -1.5V$ $V_{CE} = 450V$ $V_{BE} = -1.5V$ $T_C = 125^{\circ}C$			3 12	mA mA
I_{CEO}	Collector Cutoff Current ($I_B = 0$)	$V_{CE} = 320V$			3	mA
I_{EBO}	Emitter Cutoff Current ($I_C = 0$)	$V_{EB} = 5V$			1	mA
$V_{CE0(sus)}^*$	Collector Emitter Sustaining Voltage	$I_C = 200mA$ $L = 25mH$	400			V
V_{EBO}	Emitter-base Voltage ($I_C = 0$)	$I_E = 50mA$	7			V
$V_{CE(sat)}^*$	Collector-emitter Saturation Voltage	$I_C = 6A$ $I_B = 1.2A$ $I_C = 12A$ $I_B = 2.4A$		0.15 0.3	0.6 1	V V
$V_{BE(sat)}^*$	Base-emitter Saturation Voltage	$I_C = 12A$ $I_B = 2.4A$		1	1.5	V
h_{FE}^*	DC Current Gain	$I_C = 6A$ $V_{CE} = 4V$ $I_C = 12A$ $V_{CE} = 4V$	15 8		60	
$I_{S/B}$	Second Breakdown Collector Current	$V_{CE} = 140V$ $t = 1s$ $V_{CE} = 19V$ $t = 1s$	0.15 18			A A
f_T	Transition Frequency	$I_C = 2A$ $V_{CE} = 15V$ $f = 10MHz$	8			MHz
t_{on}	Turn-on Time	$I_C = 12A$ $I_B = 3.2A$		0.6	1.6	μs
t_s t_f	Storage Time Fall Time	$I_C = 12A$ $I_{B1} = -I_{B2} = 3.2A$		1.5 0.6	3 1.4	μs μs

* Pulsed : Pulse duration = 300 μs , duty cycle = 1.5%.

TEST CIRCUIT (V_{CE0} (sus))

Figure 1.

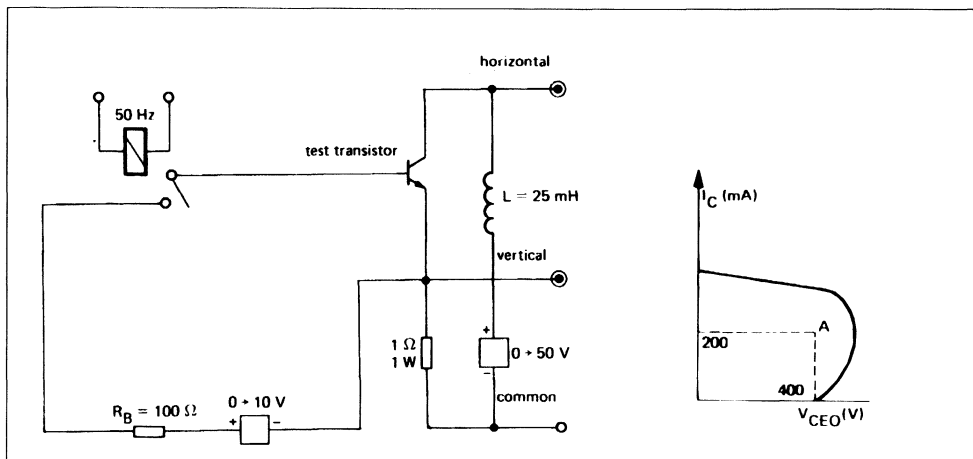

Note : The sustaining voltage V_{CE0} is acceptable when the trace falls to the right and above point "A".

SWITCHING TIMES TEST CIRCUITS (and oscillograms)

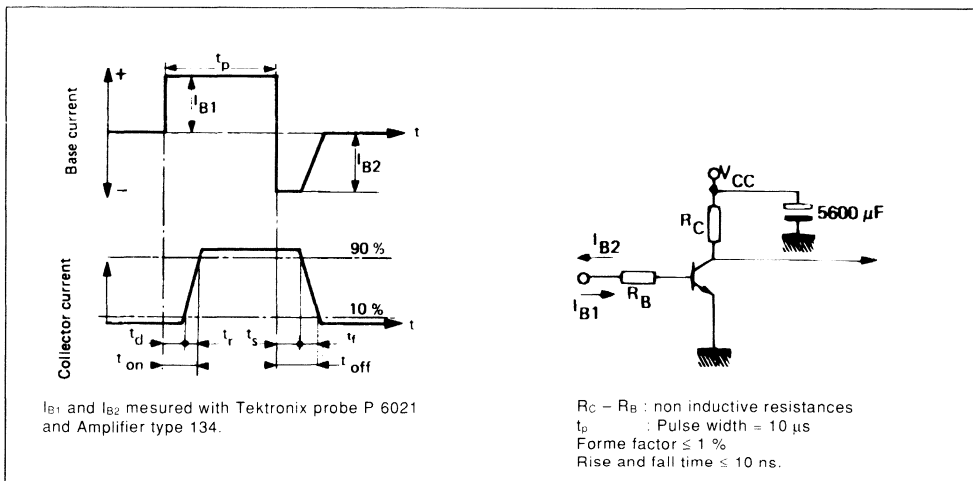

Safe Operating Area.

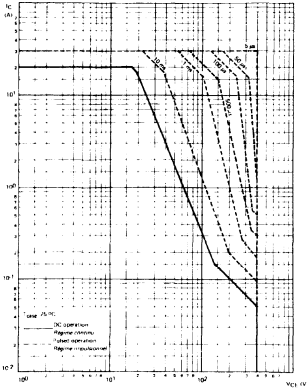

Dissipation and $I_{S/B}$ Derating.

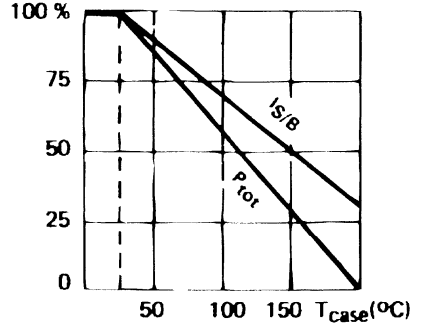

Collector Current versus Collector-emitter Voltage.

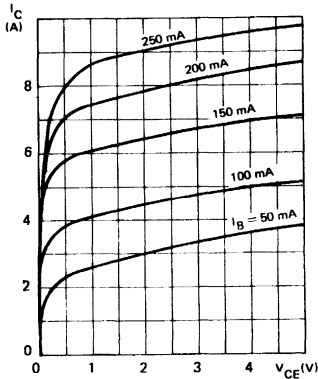

Collector Current versus Collector-emitter Voltage.

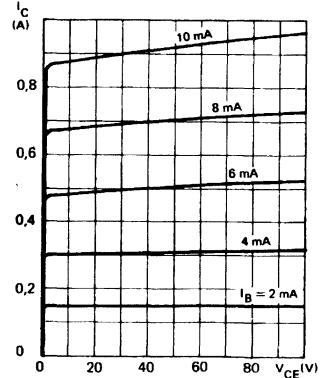

Collector Emitter Voltage versus Base-emitter Resistance (minimum value).

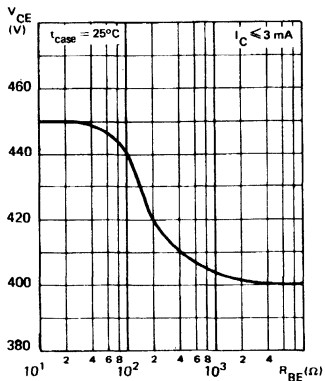

Static forward Current Transfer Ratio versus Collector Current

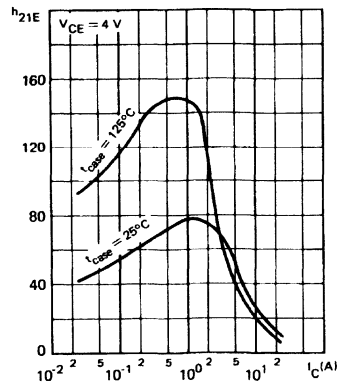

Base Current versus Base-emitter Voltage.

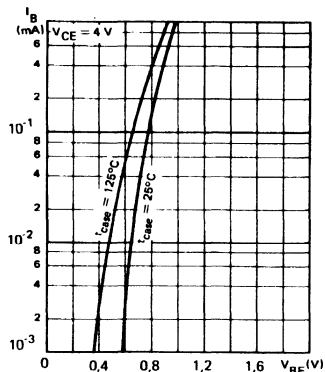

Collector Current versus Base-emitter Voltage.

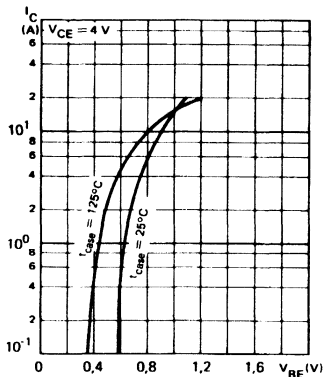

Collector-emitter Saturation Voltage versus Collector Current.

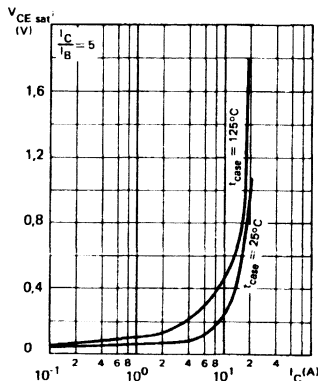

Base-emitter Saturation Voltage versus Collector Current.

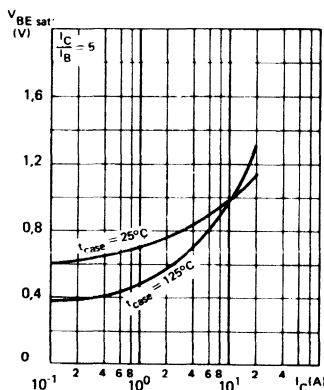

Output Capacitance versus Collector-base Voltage.

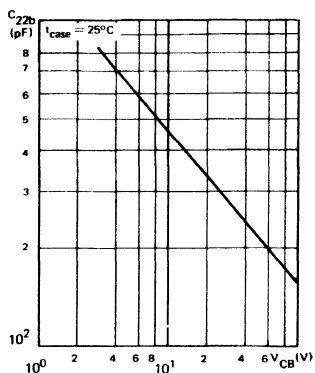

Transition Frequency versus Collector Current.

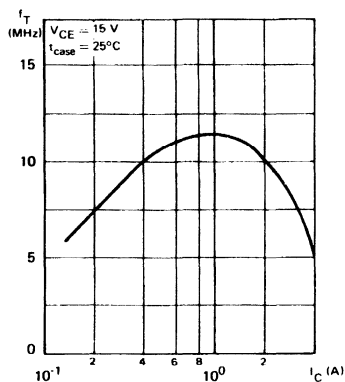

Switching Times versus Collector Current.

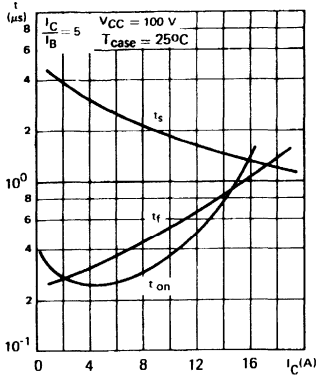

Transient Thermal Resistance Derating Factor under Pulses Conditions.

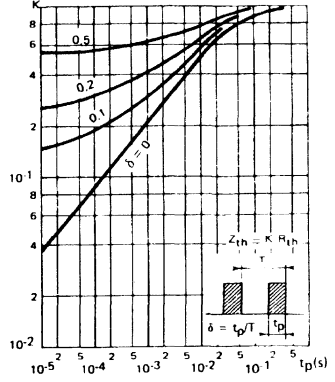

NPN SILICON TRANSISTOR

- HIGH SPEED, HIGH VOLTAGE, HIGH POWER TRANSISTOR
- SWITCHING AND AMPLIFIER TRANSISTOR

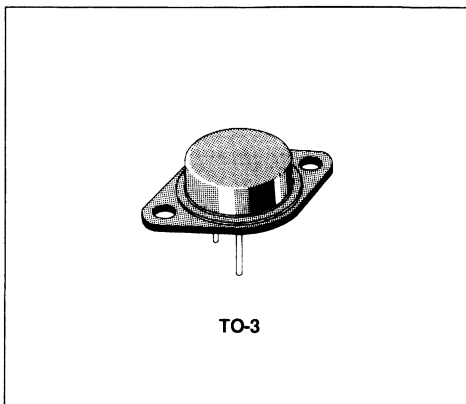
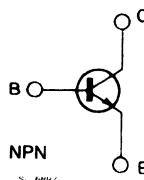
INTERNAL SCHEMATIC DIAGRAM

ABSOLUTE MAXIMUM RATINGS

Symbol	Parameter	Value	Unit
V_{CBO}	Collector-base Voltage	500	V
V_{CEO}	Collector-emitter Voltage	500	V
V_{CER}	Collector-emitter Voltage ($R_{BE} = 100\Omega$)	500	V
V_{CEX}	Collector-emitter Voltage ($V_{BE} = -1.5V$)	500	V
V_{EBO}	Emitter-base Voltage	7	V
I_C	Collector Current	15	A
I_{CM}	($t_p = 10ms$)	20	
I_B	Base Current	3	A
P_{tot}	Power Dissipation ($T_{case} 25^\circ C$)	350	W
t_j T_{stg}	Storage and Junction Temperature (max)	200 - 65 to + 200	$^\circ C$

THERMAL DATA

$R_{th(j-c)}$	Junction-case Thermal Resistance	Max	0.5	°C/W
---------------	----------------------------------	-----	-----	------

STATIC CHARACTERISTICS ($t_{case} = 25^{\circ}C$ unless otherwise stated)

Symbol	Parameter	Test Conditions	Min.	Typ.	Max.	Unit
I_{CEO}	Collector-emitter Cut-off Current	$V_{CE} = 400V$ $I_B = 0$			3	mA
I_{CEX}	Collector-emitter Cut-off Current	$V_{CE} = 500V$ $V_{BE} = -1.5V$			3	mA
		$V_{CE} = 500V$ $t_{case} = 125^{\circ}C$ $V_{BE} = -1.5V$			12	mA
I_{EBO}	Emitter-base Cut-off Current	$V_{EB} = 5V$ $I_C = 0$			1	mA
$V_{CEO(sus)}$	Collector-emitter Breakdown Voltage (fig. 1)	$I_C = 200mA$ $L = 25mH$ $I_B = 0$	500			V
$V_{(BR)EBO}$	Emitter-base Breakdown Voltage	$I_E = 50mA$ $I_C = 0$	7			V
h_{FE}^*	DC Current Gain	$V_{CE} = 4V$ $I_C = 4A$	15		60	
		$V_{CE} = 4V$ $I_C = 8A$	8			
V_{CEsat}^*	Collector-emitter Saturation Voltage	$I_C = 4A$ $I_B = 0.8A$		0.2	0.6	V
		$I_C = 8A$ $I_B = 1.6A$		0.6	1	V
V_{BEsat}^*	Base-emitter Saturation Voltage	$I_C = 8A$ $I_B = 1.6A$		1.2	1.5	V
$I_{S/B}$	Second Breakdown Collector Current	$V_{CE} = 140V$ $t = 1s$	0.15			A
		$V_{CE} = 25V$ $t = 1s$	14			A

* Pulsed $t_p = 300 \mu s$ $\delta \leq 2 \%$.

DYNAMIC CHARACTERISTICS (for small signals unless otherwise stated)

Symbol	Parameter	Test Conditions	Min.	Typ.	Max.	Unit
f_T	Transition Frequency	$V_{CE} = 15V$ $f = 10MHz$ $I_C = 2A$	8			MHz
t_{on}	Turn-on Time (fig. 2)	$I_C = 8A$ $I_B = 1.6A$		0.9	1.8	μs
t_f	Fall Time (fig. 2)	$I_C = 8A$ $I_{B1} = 1.6A$ $I_{B2} = -1.6A$		0.9	1.6	μs
t_s	Carrier Storage Time (fig. 2)	$I_C = 8A$ $I_{B1} = 1.6A$ $I_{B2} = -1.6A$		3.5	5	μs

Safe Operating Area.

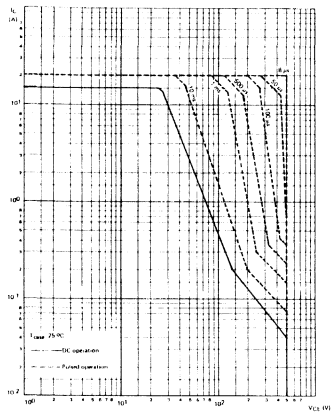

Dissipation and $I_{S/B}$ derating.

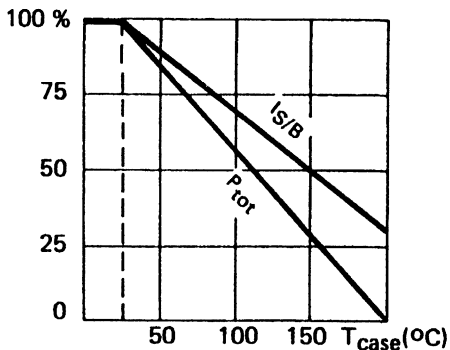
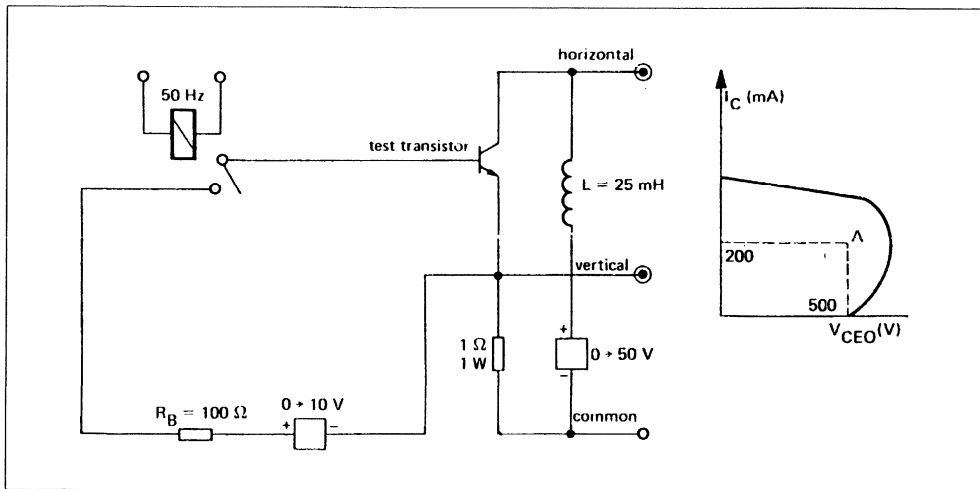
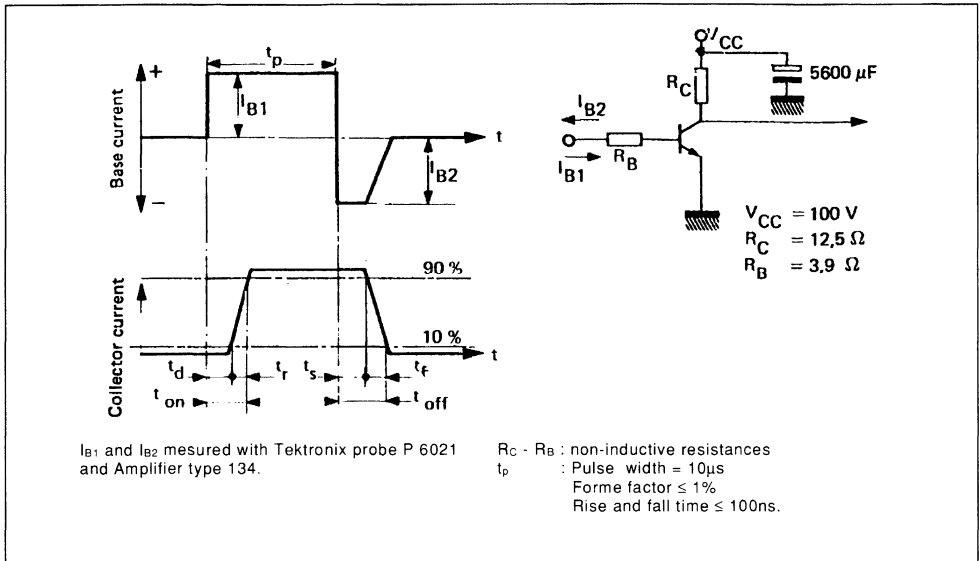

Figure 1 : Test Circuit $V_{CE0(sus)}$.



Note : The sustaining voltage V_{CE0} is acceptable when the trace falls to the right and above point "A".

Figure 2 : Switching Times Test Circuits (and oscillograms).



HIGH CURRENT, HIGH SPEED, HIGH POWER TRANSISTOR

DESCRIPTION

The BUX40 is a silicon multi-epitaxial planar NPN transistor in Jedec TO-3 metal case, intended for use in switching and linear applications in military equipment.

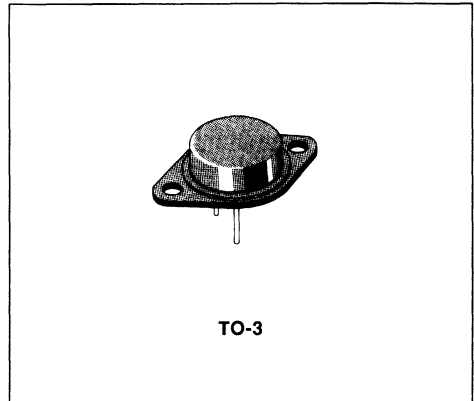

INTERNAL SCHEMATIC DIAGRAM

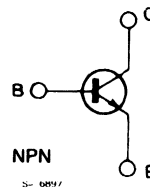

ABSOLUTE MAXIMUM RATINGS

Symbol	Parameter	Value	Unit
V_{CBO}	Collector-base Voltage ($I_E = 0$)	160	V
V_{CEX}	Collector-emitter Voltage ($V_{BE} = -1.5$ V)	160	V
V_{CEO}	Collector-emitter Voltage ($I_B = 0$)	125	V
V_{EBO}	Emitter-base Voltage ($I_C = 0$)	7	V
I_C	Collector Current	20	A
I_{CM}	Collector Peak Current ($t_p = 10$ ms)	28	A
I_B	Base Current	4	A
P_{tot}	Total Power Dissipation at $T_{case} \leq 25$ °C	120	W
T_{stg}	Storage Temperature	- 65 to 200	°C
T_j	Junction Temperature	200	°C

THERMAL DATA

$R_{th\ j-case}$	Thermal Resistance Junction-case	Max	1.46	°C/W
------------------	----------------------------------	-----	------	------

ELECTRICAL CHARACTERISTICS ($T_{case} = 25\text{ °C}$ unless otherwise specified)

Symbol	Parameter	Test Conditions	Min.	Typ.	Max.	Unit
I_{CEO}	Collector Cutoff Current ($I_B = 0$)	$V_{CE} = 100\text{ V}$			1	mA
I_{CEX}	Collector Cutoff Current	$V_{CE} = 160\text{ V}$ $V_{BE} = -1.5\text{ V}$ $T_{case} = 125\text{ °C}$ $V_{CE} = 160\text{ V}$ $V_{BE} = -1.5\text{ V}$			1 5	mA
I_{EBO}	Emitter Cutoff Current ($I_C = 0$)	$V_{EB} = 5\text{ V}$			1	mA
$V_{CEO(sus)}^*$	Collector-emitter Sustaining Voltage	$I_C = 200\text{ mA}$	125			V
V_{EBO}	Emitter-base Voltage ($I_C = 0$)	$I_E = 50\text{ mA}$	7			V
$V_{CE(sat)}^*$	Collector-emitter Saturation Voltage	$I_C = 10\text{ A}$ $I_B = 1\text{ A}$ $I_C = 15\text{ A}$ $I_B = 1.88\text{ A}$		0.6 0.9	1.2 1.6	V
$V_{BE(sat)}^*$	Base-emitter Saturation Voltage	$I_C = 15\text{ A}$ $I_B = 1.88\text{ A}$		1.7	2	V
h_{FE}^*	DC Current Gain	$I_C = 10\text{ A}$ $V_{CE} = 4\text{ V}$ $I_C = 15\text{ A}$ $V_{CE} = 4\text{ V}$	15 8		45	
$I_{s/b}$	Second Breakdown Collector Current	$V_{CE} = 30\text{ V}$ $t = 1\text{ s}$ $V_{CE} = 50\text{ V}$ $t = 1\text{ s}$	4 1			A
f_T	Transition Frequency	$I_C = 1\text{ A}$ $V_{CE} = 15\text{ V}$ $f = 10\text{ MHz}$	8			MHz
t_{on}	Turn-on Time (see fig. 2)	$I_C = 15\text{ A}$ $I_{B1} = 1.88\text{ A}$ $V_{CC} = 30\text{ V}$		0.35	1.2	μs
t_s	Storage Time (see fig. 2)	$I_C = 15\text{ A}$ $I_{B1} = -I_{B2} = 1.88\text{ A}$ $V_{CC} = 30\text{ V}$		0.85	1	μs
t_f	Fall Time (see fig. 2)			0.14	0.4	μs
	Clamped $E_{s/b}$ Collector Current (see fig. 1)	$V_{clamp} = 125\text{ V}$ $L = 500\text{ μH}$	15			A

* Pulsed : pulse duration = 300 μs, duty cycle ≤ 2 %.

Safe Operating Areas.

Derating Curves.

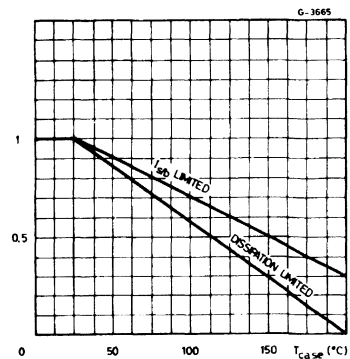
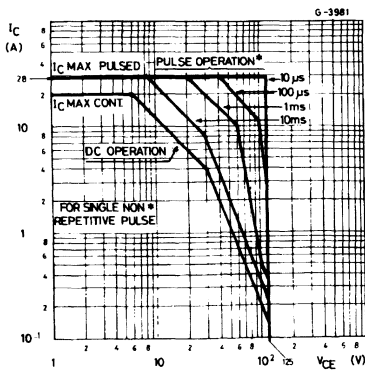

Thermal Transient Response.

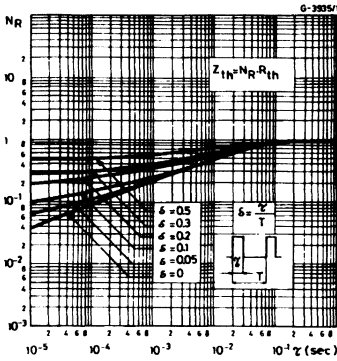

DC Current Gain.

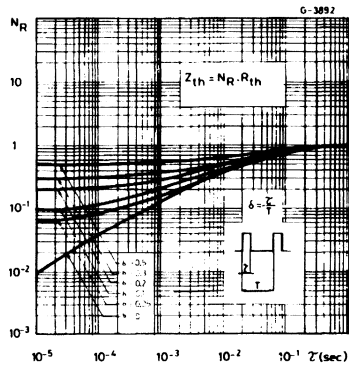

Collector-emitter Saturation Voltage.

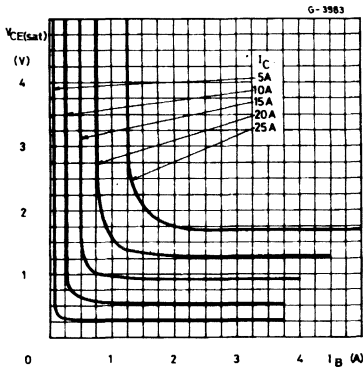

Collector-emitter Saturation Voltage.

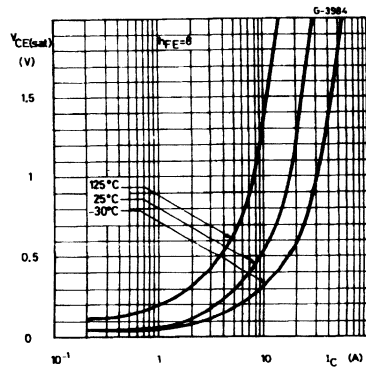

Base-emitter Saturation Voltage.

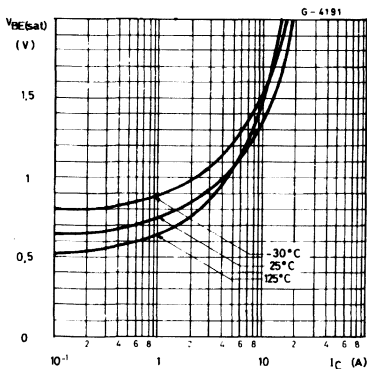

Saturated Switching Characteristics.

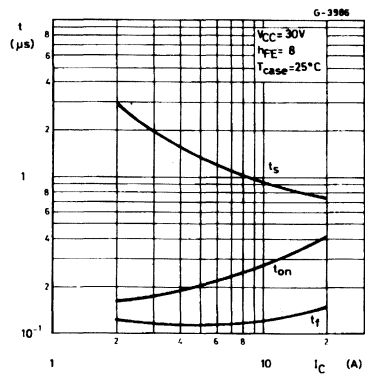

Saturated Switching Characteristics.

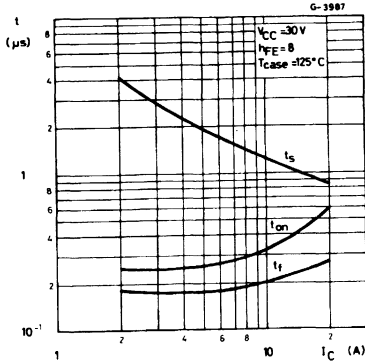

Transition Frequency.

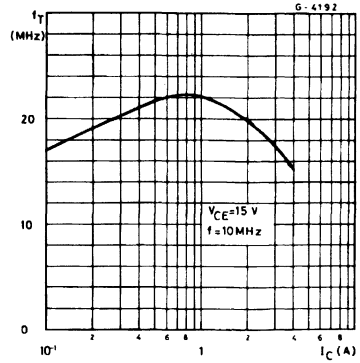

Collector-base Capacitance.

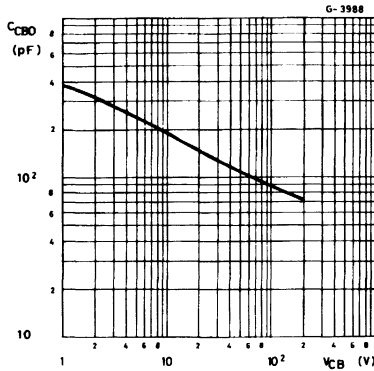

Clamped Reverse Bias Safe Operating Areas.

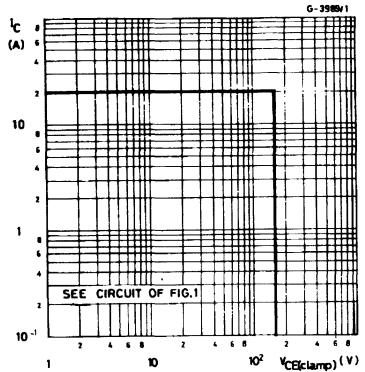

Figure 1 : Clamped $E_{S/b}$ Test Circuit.

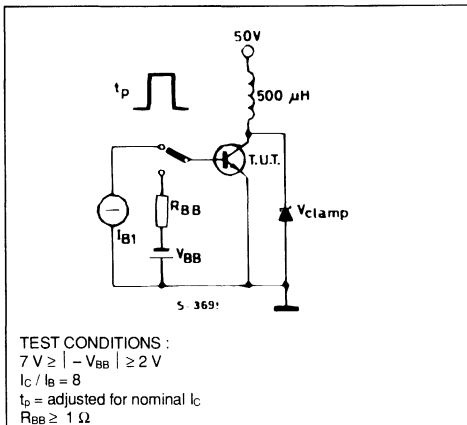
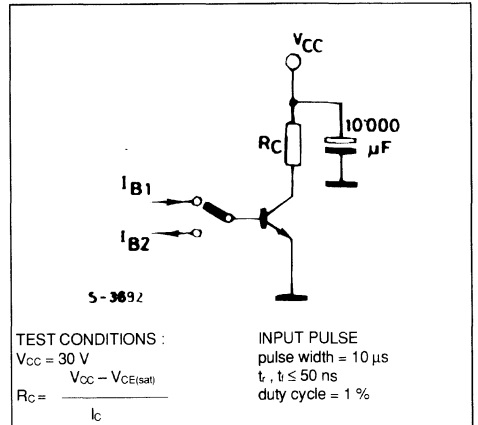

Figure 2 : Switching Times Test Circuit (resistive load).



HIGH CURRENT, HIGH SPEED, HIGH POWER TRANSISTOR

DESCRIPTION

The BUX41 is a silicon multi-epitaxial planar NPN transistor in Jedec TO-3 metal case, intended for use in switching and linear applications in military and industrial equipment.

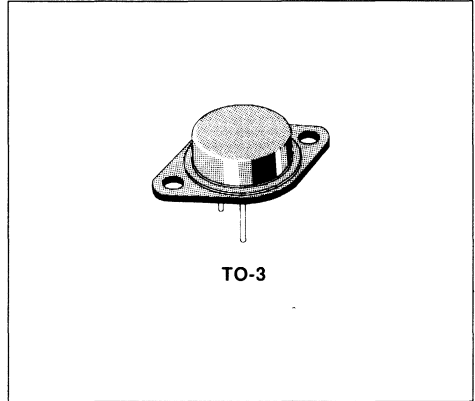

INTERNAL SCHEMATIC DIAGRAM

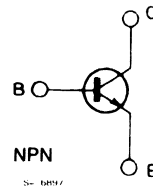

ABSOLUTE MAXIMUM RATINGS

Symbol	Parameter	Value	Unit
V_{CB0}	Collector-base Voltage ($I_E = 0$)	250	V
V_{CEX}	Collector-emitter Voltage ($V_{BE} = -1.5$ V)	250	V
V_{CEO}	Collector-emitter Voltage ($I_B = 0$)	200	V
V_{EBO}	Emitter-base Voltage ($I_C = 0$)	7	V
I_C	Collector Current	15	A
I_{CM}	Collector Peak Current ($t_p = 10$ ms)	20	A
I_B	Base Current	3	A
P_{tot}	Total Power Dissipation at $T_{case} \leq 25$ °C	120	W
T_{stg}	Storage Temperature	- 65 to 200	°C
T_j	Junction Temperature	200	°C

THERMAL DATA

$R_{th\ j-case}$	Thermal Resistance Junction-case	Max	1.46	°C/W
------------------	----------------------------------	-----	------	------

ELECTRICAL CHARACTERISTICS ($T_{case} = 25\text{ °C}$ unless otherwise specified)

Symbol	Parameter	Test Conditions	Min.	Typ.	Max.	Unit
I_{CEO}	Collector Cutoff Current ($I_B = 0$)	$V_{CE} = 160\text{ V}$			1	mA
I_{CEX}	Collector Cutoff Current	$V_{CE} = 250\text{ V}$ $V_{BE} = -1.5\text{ V}$ $T_{case} = 125\text{ °C}$ $V_{CE} = 250\text{ V}$ $V_{BE} = -1.5\text{ V}$			1 5	mA
I_{EBO}	Emitter Cutoff Current ($I_C = 0$)	$V_{EB} = 5\text{ V}$			1	mA
$V_{CEO(sus)}^*$	Collector-emitter Sustaining Voltage	$I_C = 200\text{ mA}$	200			V
V_{EBO}	Emitter-base Voltage ($I_C = 0$)	$I_E = 50\text{ mA}$	7			V
$V_{CE(sat)}^*$	Collector-emitter Saturation Voltage	$I_C = 5\text{ A}$ $I_B = 0.5\text{ A}$ $I_C = 8\text{ A}$ $I_B = 1\text{ A}$		0.38 0.6	1.2 1.6	V
$V_{BE(sat)}^*$	Base-emitter Saturation Voltage	$I_C = 8\text{ A}$ $I_B = 1\text{ A}$		1.35	2	V
h_{FE}^*	DC Current Gain	$I_C = 5\text{ A}$ $V_{CE} = 4\text{ V}$ $I_C = 8\text{ A}$ $V_{CE} = 4\text{ V}$	15 8		45	
$I_{s/b}$	Second Breakdown Collector Current	$V_{CE} = 30\text{ V}$ $t = 1\text{ s}$ $V_{CE} = 135\text{ V}$ $t = 1\text{ s}$	4 0.15			A
f_T	Transition Frequency	$I_C = 1\text{ A}$ $V_{CE} = 15\text{ V}$ $f = 10\text{ MHz}$	8			MHz
t_{on}	Turn-on Time (fig. 2)	$I_C = 8\text{ A}$ $I_{B1} = 1\text{ A}$ $V_{CC} = 150\text{ V}$		0.28	1	μs
t_s	Storage Time (fig. 2)	$I_C = 8\text{ A}$ $I_{B1} = 1\text{ A}$		1.2	1.7	μs
t_f	Fall Time (fig. 2)	$I_{B2} = -1\text{ A}$ $V_{CC} = 150\text{ V}$		0.25	0.8	μs
	Clamped $E_{s/b}$ Collector Current (fig. 1)	$V_{clamp} = 200\text{ V}$ $L = 500\text{ μH}$	8			A

* Pulsed : pulse duration = 300 μs, duty cycle ≤ 2 %.

Safe Operating Areas.

Derating Curves.

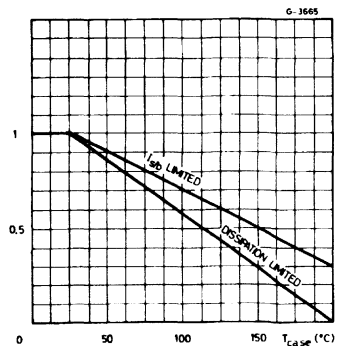
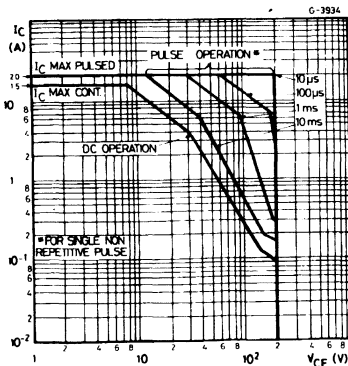

Thermal Transient Response.

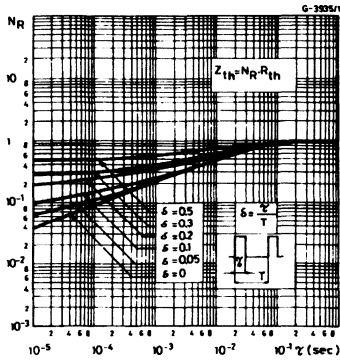

DC Current Gain.

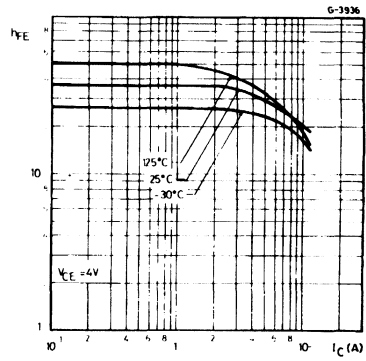

Collector-emitter Saturation Voltage.

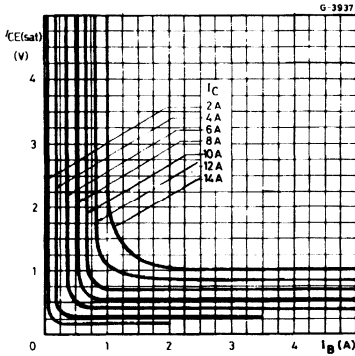

Collector-emitter Saturation Voltage.

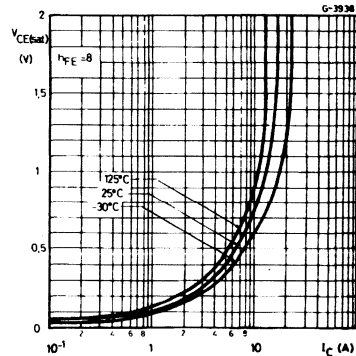

Base-emitter Saturation Voltage.

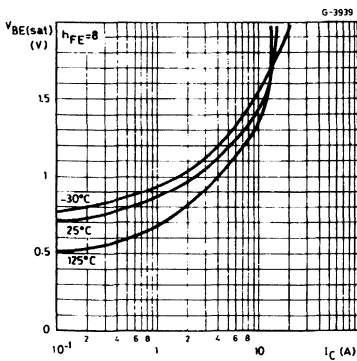

Saturated Switching Characteristics.

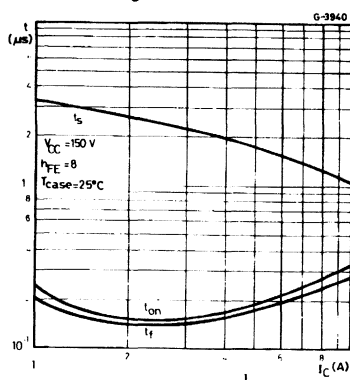

Saturated Switching Characteristics.

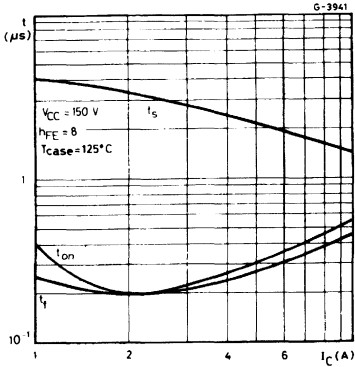

Transition Frequency.

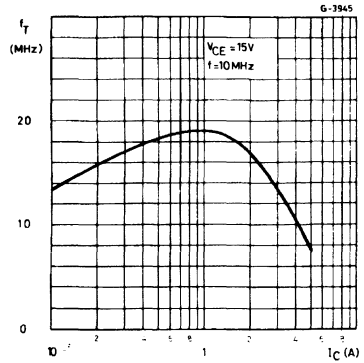

Collector-base Capacitance.

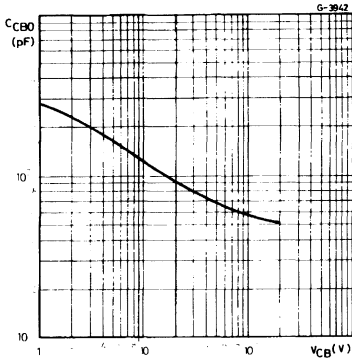

Clamped Reverse Bias Safe Operating Area.

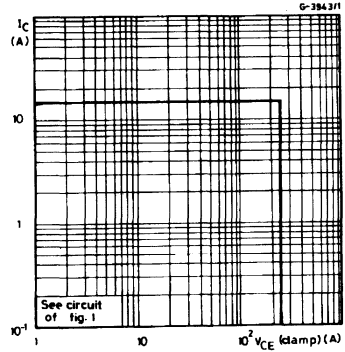
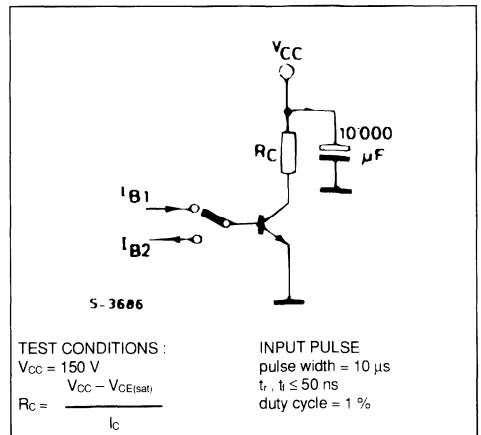
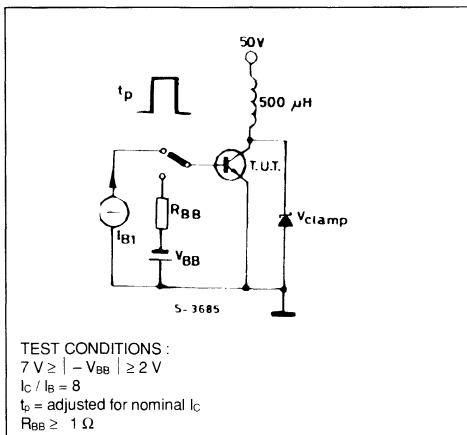

Figure 1 : Clamped E_{s/b} Test Circuit.

Figure 2 : Switching Times Test Circuit (resistive load).



HIGH CURRENT, HIGH SPEED, HIGH POWER TRANSISTOR

DESCRIPTION

The BUX41N is a silicon multi-epitaxial planar NPN transistor in Jedec TO-3 metal case, intended for use in switching and linear applications in military and industrial equipment.

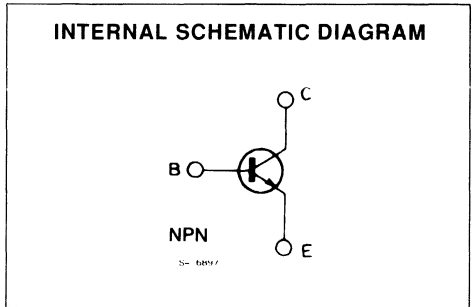
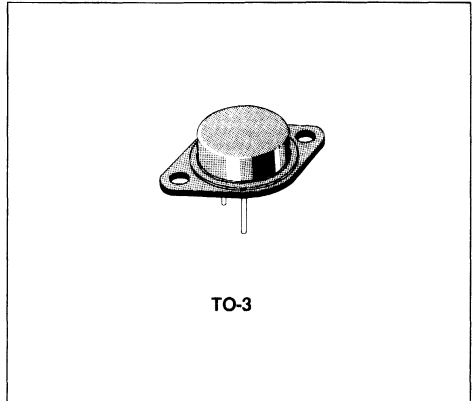

ABSOLUTE MAXIMUM RATINGS

Symbol	Parameter	Value	Unit
V_{CBO}	Collector-base Voltage ($I_E = 0$)	220	V
V_{CEX}	Collector-emitter Voltage ($V_{BE} = -1.5$ V)	220	V
V_{CEO}	Collector-emitter Voltage ($I_B = 0$)	160	V
V_{EBO}	Emitter-base Voltage ($I_C = 0$)	7	V
I_C	Collector Current	18	A
I_{CM}	Collector Peak Current ($t_p = 10$ ms)	25	A
I_B	Base Current	3.6	A
P_{tot}	Total Power Dissipation at $T_{case} \leq 25$ °C	120	W
T_{stg}	Storage Temperature	- 65 to 200	°C
T_j	Junction Temperature	200	°C

THERMAL DATA

$R_{th\ j-case}$	Thermal Resistance Junction-case	Max	1.46	°C/W
------------------	----------------------------------	-----	------	------

ELECTRICAL CHARACTERISTICS ($T_{case} = 25\text{ °C}$ unless otherwise specified)

Symbol	Parameter	Test Conditions	Min.	Typ.	Max.	Unit
I_{CEO}	Collector Cutoff Current ($I_B = 0$)	$V_{CE} = 130\text{ V}$			1	mA
I_{CEX}	Collector Cutoff Current	$V_{CE} = 220\text{ V}$ $V_{BE} = -1.5\text{ V}$			1	mA
		$T_{case} = 125\text{ °C}$ $V_{CE} = 220\text{ V}$ $V_{BE} = -1.5\text{ V}$			5	mA
I_{EBO}	Emitter Cutoff Current ($I_C = 0$)	$V_{EB} = 5\text{ V}$			1	mA
$V_{CEO(sus)*}$	Collector-emitter Sustaining Voltage	$I_C = 200\text{ mA}$	160			V
V_{EBO}	Emitter-base Voltage ($I_C = 0$)	$I_E = 50\text{ mA}$	7			V
$V_{CE(sat)*}$	Collector-emitter Saturation Voltage	$I_C = 8\text{ A}$ $I_B = 0.8\text{ A}$		0.5	1.2	V
		$I_C = 12\text{ A}$ $I_B = 1.5\text{ A}$		0.75	1.6	V
$V_{BE(sat)*}$	Base-emitter Saturation Voltage	$I_C = 12\text{ A}$ $I_B = 1.5\text{ A}$		1.5	2	V
h_{FE*}	DC Current Gain	$I_C = 8\text{ A}$ $V_{CE} = 4\text{ V}$	15		45	
		$I_C = 12\text{ A}$ $V_{CE} = 4\text{ V}$	8			
$I_{s/b}$	Second Breakdown Collector Current	$V_{CE} = 30\text{ V}$ $t = 1\text{ s}$	4			A
		$V_{CE} = 100\text{ V}$ $t = 1\text{ s}$	0.27			A
f_T	Transition Frequency	$I_C = 1\text{ A}$ $V_{CE} = 15\text{ V}$ $f = 10\text{ MHz}$	8			MHz
t_{on}	Turn-on Time (fig. 2)	$I_C = 12\text{ A}$ $I_{B1} = 1.5\text{ A}$ $V_{CC} = 30\text{ V}$		0.35	1.3	μs
t_s	Storage Time (fig. 2)	$I_C = 12\text{ A}$ $I_{B1} = -I_{B2} = 1.5\text{ A}$ $V_{CC} = 30\text{ V}$		0.85	1.5	μs
t_f	Fall Time (fig. 2)			0.14	0.8	μs
	Clamped $E_{s/b}$ Collector Current (fig. 1)	$V_{clamp} = 160\text{ V}$ $L = 500\text{ μH}$	12			A

* Pulsed : pulse duration = 300 μs, duty cycle ≤ 2%.

Safe Operating Areas.

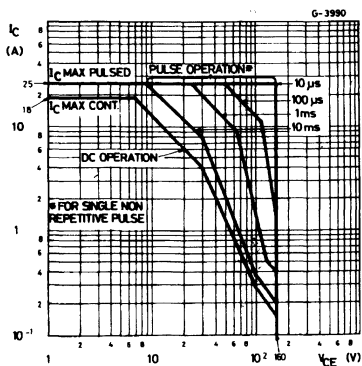

Derating Curves.

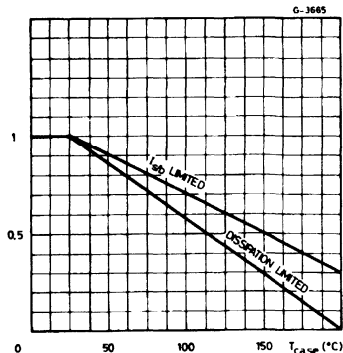

Thermal Transient Response.

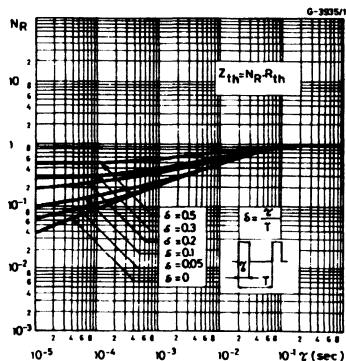

DC Current Gain.

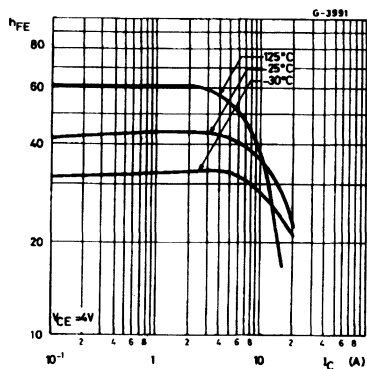

Collector-emitter Saturation Voltage.

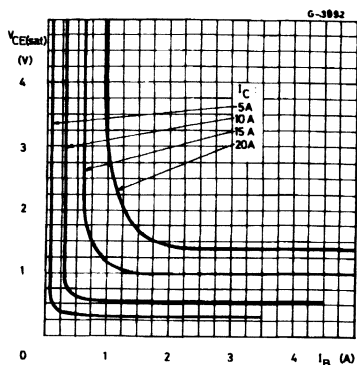

Collector-emitter Saturation Voltage.

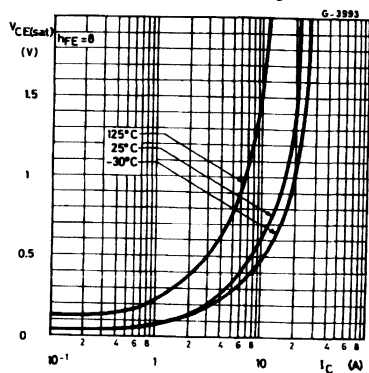

Base-emitter Saturation Voltage.

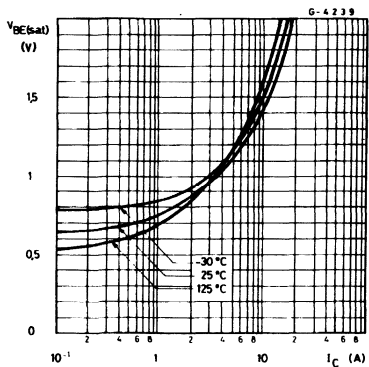

Saturated Switching Characteristics.

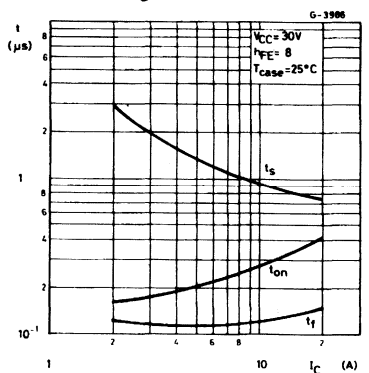

Saturated Switching Characteristics.

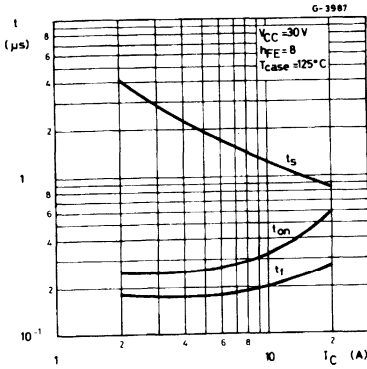

Transition Frequency.

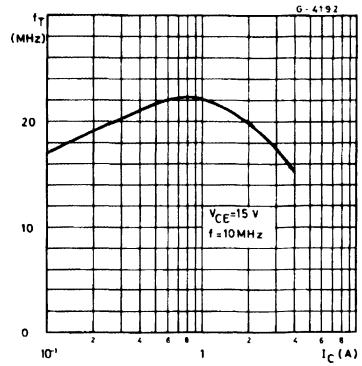

Collector-base Capacitance.

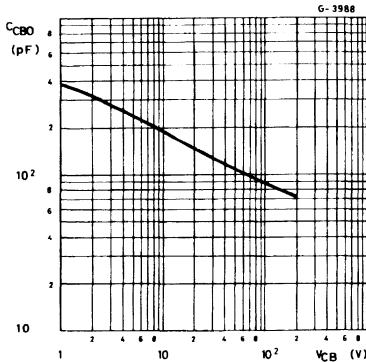

Clamped Reverse Bias Safe Operating Areas.

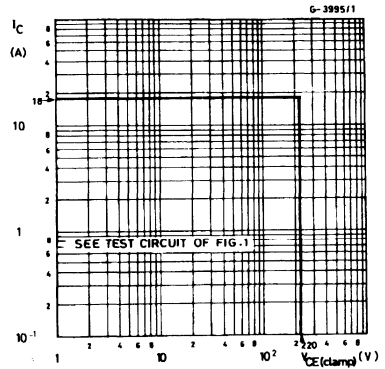
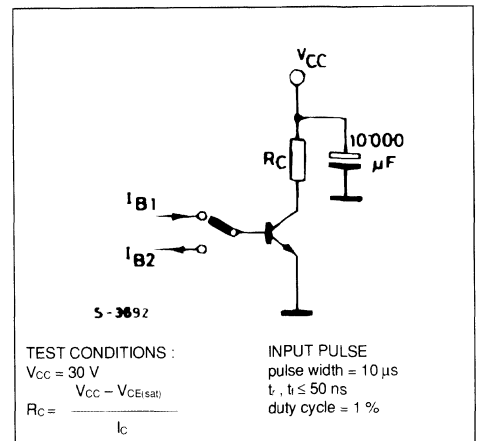
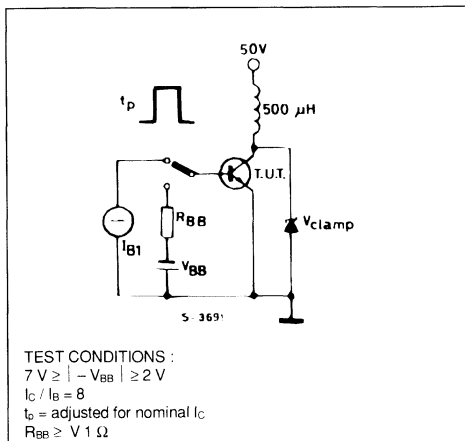

Figure 1 : Clamped $E_{s/b}$ Test Circuit.

Figure 2 : Switching Times Test Circuit (resistive load).



HIGH CURRENT, HIGH SPEED, HIGH POWER TRANSISTOR

DESCRIPTION

The BUX42 is a silicon multiepitaxial planar NPN transistor in Jedec TO-3 metal case, intended for use in switching and linear applications in military and industrial equipment.

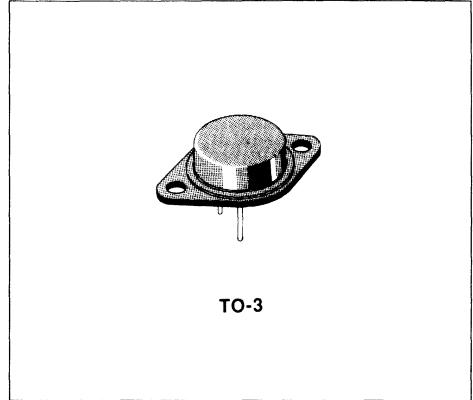

INTERNAL SCHEMATIC DIAGRAM

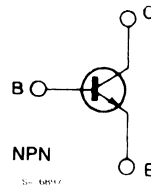

ABSOLUTE MAXIMUM RATINGS

Symbol	Parameter	Value	Unit
V_{CBO}	Collector-base Voltage ($I_E = 0$)	300	V
V_{CEX}	Collector-emitter Voltage ($V_{BE} = -1.5$ V)	300	V
V_{CEO}	Collector-emitter Voltage ($I_B = 0$)	250	V
V_{EBO}	Emitter-base Voltage ($I_C = 0$)	7	V
I_C	Collector Current	12	A
I_{CM}	Collector Peak Current ($t_p = 10$ ms)	15	A
I_B	Base Current	2.4	A
P_{tot}	Total Power Dissipation at $T_{case} \leq 25$ °C	120	W
T_{stg}	Storage Temperature	- 65 to 200	°C
T_J	Junction Temperature	200	°C

THERMAL DATA

$R_{th(j-case)}$	Thermal Resistance Junction-case	Max	1.46	°C/W
------------------	----------------------------------	-----	------	------

ELECTRICAL CHARACTERISTICS ($T_{case} = 25\text{ °C}$ unless otherwise specified)

Symbol	Parameter	Test Conditions	Min.	Typ.	Max.	Unit
I_{CEO}	Collector Cutoff Current ($I_B = 0$)	$V_{CE} = 200\text{ V}$			1	mA
I_{CEX}	Collector Cutoff Current	$V_{CE} = 300\text{ V}$ $V_{BE} = -1.5\text{ V}$			1	mA
		$T_{case} = 125\text{ °C}$			5	mA
I_{EBO}	Emitter Cutoff Current ($I_C = 0$)	$V_{EB} = 5\text{ V}$			1	mA
$V_{CEO(sus)*}$	Collector-emitter Sustaining Voltage	$I_C = 200\text{ mA}$	250			V
V_{EBO}	Emitter-base Voltage ($I_C = 0$)	$I_E = 50\text{ mA}$	7			V
$V_{CE(sat)*}$	Collector-emitter Saturation Voltage	$I_C = 4\text{ A}$ $I_B = 0.4\text{ A}$		0.33	1.2	V
		$I_C = 6\text{ A}$ $I_B = 0.75\text{ A}$		0.45	1.6	V
$V_{BE(sat)*}$	Base-emitter Saturation Voltage	$I_C = 6\text{ A}$ $I_B = 0.75\text{ A}$		1.23	2	V
h_{FE*}	DC Current Gain	$I_C = 4\text{ A}$ $V_{CE} = 4\text{ V}$	15		45	
		$I_C = 6\text{ A}$ $V_{CE} = 4\text{ V}$	8			
$I_{s/b}$	Second Breakdown Collector Current	$V_{CE} = 135\text{ V}$ $t = 1\text{ s}$	0.15			A
		$V_{CE} = 30\text{ V}$ $t = 1\text{ s}$	4			A
f_T	Transition Frequency	$I_C = 1\text{ A}$ $V_{CE} = 15\text{ V}$ $f = 10\text{ MHz}$	8			MHz
t_{on}	Turn-on Time (fig. 2)	$I_C = 6\text{ A}$ $I_{B1} = 0.75\text{ A}$ $V_{CC} = 150\text{ V}$		0.23	1	μs
t_s	Storage Time (fig. 2)	$I_C = 6\text{ A}$ $I_{B1} = 0.75\text{ A}$ $I_{B2} = -0.75\text{ A}$ $V_{CC} = 150\text{ V}$		1.5	2	μs
t_f	Fall Time (fig. 2)			0.2	1.2	μs
	Clamped $E_{s,b}$ Collector Current (fig. 1)	$V_{clamp} = 250\text{ V}$ $L = 500\text{ μH}$	6			A

* Pulsed : pulse duration = 300 μs, duty cycle ≤ 2 %.

Safe Operating Areas.

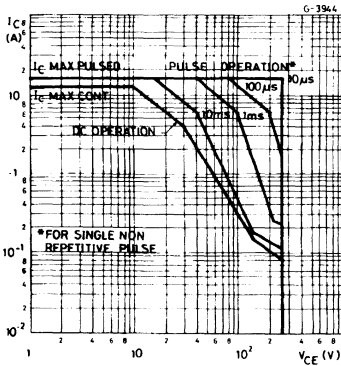

Derating Curves.

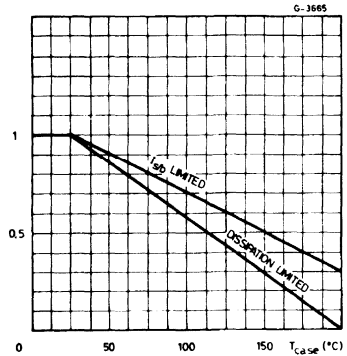

Thermal Transient Response.

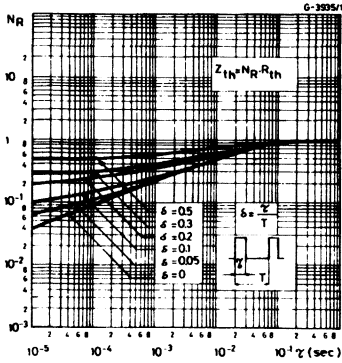

DC Current Gain.

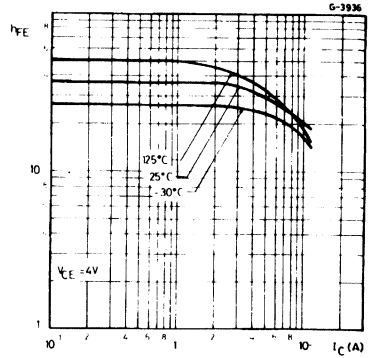

Collector-emitter Saturation Voltage.

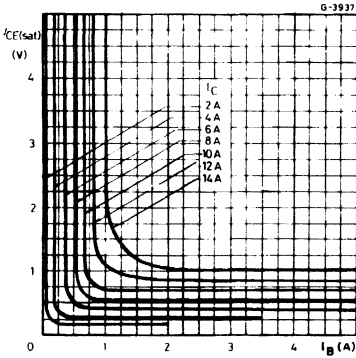

Collector-emitter Saturation Voltage.

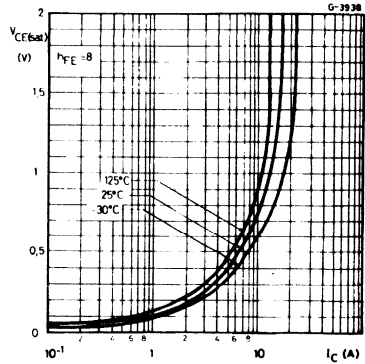

Base-emitter Saturation Voltage.

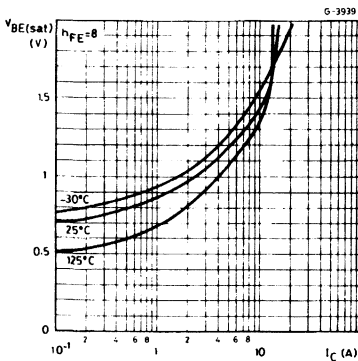

Saturated Switching Characteristics.

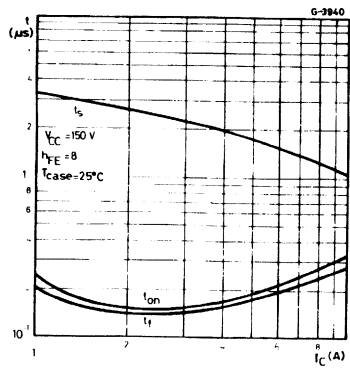

Saturated Switching Characteristics.

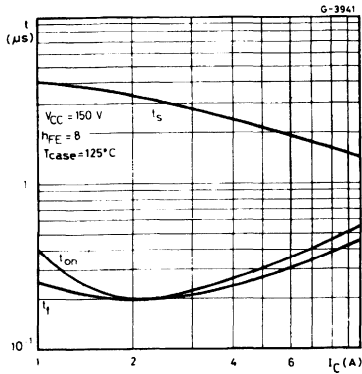

Transition Frequency.

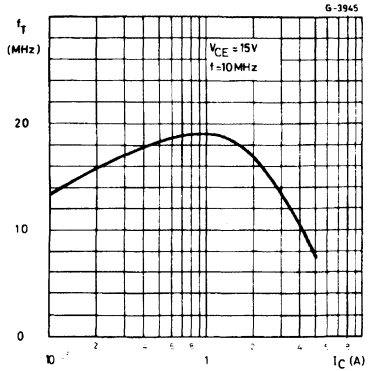

Collector-base Capacitance.

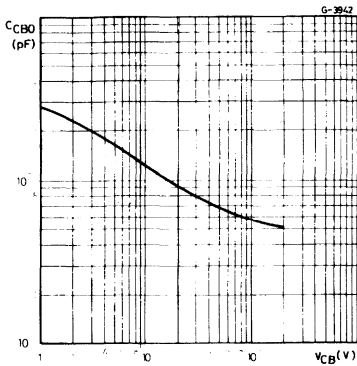

Clamped Reverse Bias Safe Operating Areas.

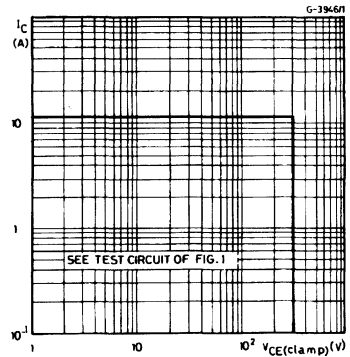
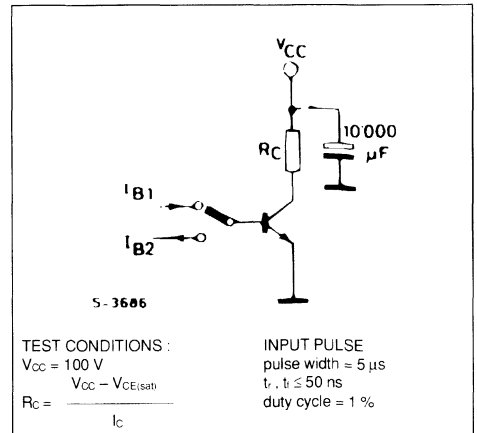
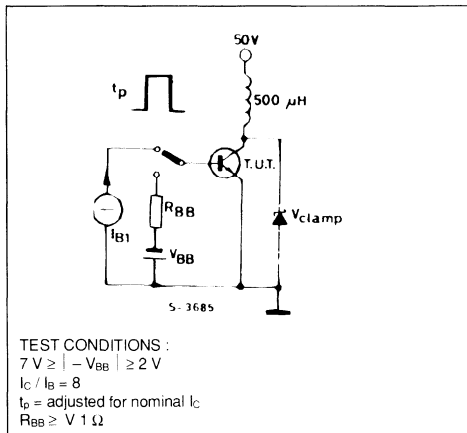

Figure 1 : Clamped $E_{s/b}$ Test Circuit.

Figure 2 : Switching Times Test Circuit (resistive load).



HIGH VOLTAGE POWER SWITCH

DESCRIPTION

The BUX43 is a silicon multiepitaxial mesa NPN transistor in Jedec TO-3 metal case, intended for high voltage, fast switching applications.

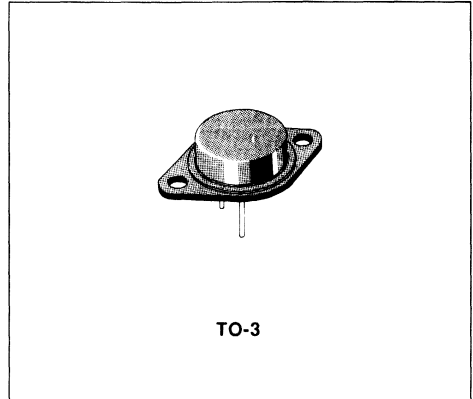

INTERNAL SCHEMATIC DIAGRAM

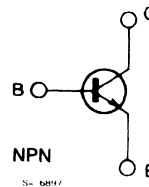

ABSOLUTE MAXIMUM RATINGS

Symbol	Parameter	Value	Unit
V_{CES}	Collector-emitter Voltage ($V_{BE} = 0$)	400	V
V_{CER}	Collector-emitter Voltage ($R_{BE} \leq 100 \Omega$)	360	V
V_{CEO}	Collector-emitter Voltage ($I_C = 0$)	325	V
V_{EBO}	Base-emitter Voltage ($I_C = 0$)	7	V
I_C	Collector Current	10	A
I_{CM}	Collector Peak Current ($t_p \leq 10$ ms)	12	A
I_B	Base Current	2	A
P_{tot}	Total Power Dissipation at $T_{case} \leq 25$ °C	120	W
T_{stg}	Storage Temperature	- 65 to 200	°C
T_J	Junction Temperature	200	°C

THERMAL DATA

$R_{th\ j-case}$	Thermal Resistance Junction-case	Max	1.46	°C/W
------------------	----------------------------------	-----	------	------

ELECTRICAL CHARACTERISTICS ($T_{case} = 25\text{ °C}$ unless otherwise specified)

Symbol	Parameter	Test Conditions	Min.	Typ.	Max.	Unit
I_{CES}	Collector Cutoff Current ($V_{BE} = 0$)	$V_{CE} = 400\text{ V}$ $V_{CE} = 400\text{ V}$ $T_{case} = 125\text{ °C}$			1 5	mA mA
I_{CEO}	Collector Cutoff Current ($I_B = 0$)	$V_{CE} = 260\text{ V}$			1	mA
I_{EBO}	Emitter Cutoff Current ($I_C = 0$)	$V_{EB} = 7\text{ V}$			1	mA
$V_{CEO(sus)}^*$	Collector-emitter Sustaining Voltage ($I_B = 0$)	$I_C = 100\text{ mA}$	325			V
$V_{CE(sat)}^*$	Collector-emitter Saturation Voltage	$I_C = 3\text{ A}$ $I_B = 0.375\text{ A}$ $I_C = 5\text{ A}$ $I_B = 1\text{ A}$			1 1.6	V V
$V_{BE(sat)}^*$	Base-emitter Saturation Voltage	$I_C = 5\text{ A}$ $I_B = 1\text{ A}$			2	V
h_{FE}^*	DC Current Gain	$I_C = 3\text{ A}$ $V_{CE} = 4\text{ V}$ $I_C = 5\text{ A}$ $V_{CE} = 4\text{ V}$	15 8		60	
f_T	Transition Frequency	$I_C = 1\text{ A}$ $V_{CE} = 15\text{ V}$ $f = 10\text{ MHz}$	8			MHz
t_{on}	Turn-on Time	$I_C = 5\text{ A}$ $I_{B1} = 1\text{ A}$ $V_{CC} = 150\text{ V}$			1	μs
t_s	Storage Time	$I_C = 5\text{ A}$ $I_{B1} = -I_{B2} = 1\text{ A}$ $V_{CC} = 150\text{ V}$			2.2	μs
t_f	Fall Time				1.2	μs

* Pulsed : pulse duration = 300 μs, duty cycle ≤ 2 %.

HIGH VOLTAGE POWER SWITCH

DESCRIPTION

The BUX44 is a silicon multi-epitaxial mesa NPN transistor in Jedec TO-3 metal case, intended for high voltage, fast switching applications.

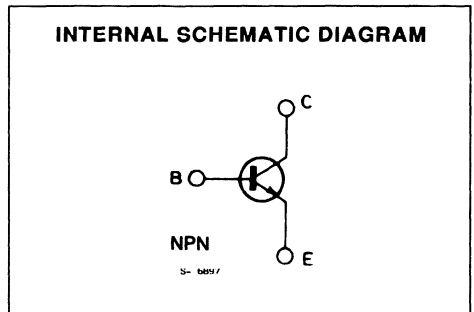
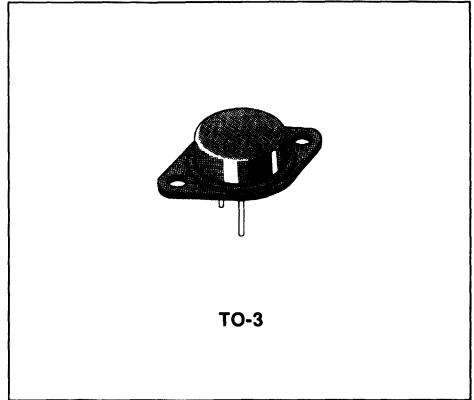

ABSOLUTE MAXIMUM RATINGS

Symbol	Parameter	Value	Unit
V_{CES}	Collector-emitter Voltage ($V_{BE} = 0$)	450	V
V_{CER}	Collector-emitter Voltage ($R_{BE} \leq 100 \Omega$)	440	V
V_{CEO}	Collector-emitter Voltage ($I_B = 0$)	400	V
V_{EBO}	Emitter-base Voltage ($I_C = 0$)	7	V
I_C	Collector Current	8	A
I_{CM}	Collector Peak Current ($t_p \leq 10$ ms)	10	A
I_B	Base Current	1.6	A
P_{tot}	Total Power Dissipation at $T_{case} \leq 25^\circ C$	120	W
T_{stg}	Storage Temperature	- 65 to 200	$^\circ C$
T_j	Junction Temperature	200	$^\circ C$

THERMAL DATA

$R_{th\ j-case}$	Thermal Resistance Junction-case	Max	1.46	°C/W
------------------	----------------------------------	-----	------	------

ELECTRICAL CHARACTERISTICS ($T_{case} = 25\text{ °C}$ unless otherwise specified)

Symbol	Parameter	Test Conditions	Min.	Typ.	Max.	Unit
I_{CES}	Collector Cutoff Current ($V_{BE} = 0$)	$V_{CE} = 450\text{ V}$ $V_{CE} = 450\text{ V}$ $T_{case} = 125\text{ °C}$			1 5	mA mA
I_{CEO}	Collector Cutoff Current ($I_B = 0$)	$V_{CE} = 320\text{ V}$			1	mA
I_{EBO}	Emitter Cutoff Current ($I_C = 0$)	$V_{EB} = 7\text{ V}$			1	mA
$V_{CEO(sus)}^*$	Collector-emitter Sustaining Voltage ($I_B = 0$)	$I_C = 100\text{ mA}$	400			V
$V_{CE(sat)}^*$	Collector-emitter Saturation Voltage	$I_C = 2\text{ A}$ $I_B = 0.25\text{ A}$ $I_C = 4\text{ A}$ $I_B = 0.8\text{ A}$			1 2	V V
$V_{BE(sat)}^*$	Base-emitter Saturation Voltage	$I_C = 4\text{ A}$ $I_B = 0.8\text{ A}$			2	V
h_{FE}^*	DC Current Gain	$I_C = 2\text{ A}$ $V_{CE} = 4\text{ V}$ $I_C = 4\text{ A}$ $V_{CE} = 4\text{ V}$	15 8		45	
f_T	Transition Frequency	$I_C = 1\text{ A}$ $V_{CE} = 15\text{ V}$ $f = 10\text{ MHz}$	8			MHz
t_{on}	Turn-on Time	$I_C = 4\text{ A}$ $I_B = 0.8\text{ A}$ $V_{CC} = 150\text{ V}$			1	μs
t_s	Storage Time	$I_C = 4\text{ A}$ $I_{B1} = -I_{B2} = 0.8\text{ A}$			2.5	μs
t_f	Fall Time	$V_{CC} = 150\text{ V}$			1.2	μs

* Pulsed : pulse duration = 300 μs, duty cycle ≤ 2 %.

HIGH VOLTAGE POWER SWITCH

DESCRIPTION

The BUX47/A, BUV47/A, BUV47FI/AFI are silicon multiepitaxial mesa NPN transistors mounted respectively in TO-3 metal case, TO-218 plastic package and ISOWATT218 fully isolated package.

They are intended for high voltage, fast switching applications.

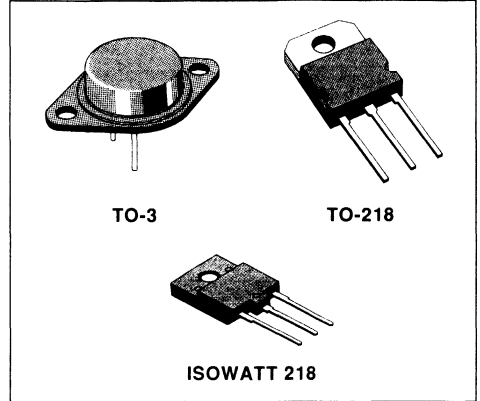

INTERNAL SCHEMATIC DIAGRAM

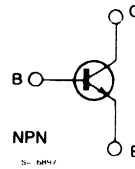

ABSOLUTE MAXIMUM RATINGS

Symbol	Parameter	Value			Unit
		BUX47 BUV47 BUV47FI	TO-218	BUX47A BUV47A BUV47AFI	
V_{CER}	Collector-emitter Voltage ($R_{BE} = 10 \Omega$)	850		1000	V
V_{CES}	Collector-emitter Voltage ($V_{BE} = 0$)	850		900	V
V_{CEO}	Collector-emitter Voltage ($I_B = 0$)	400		450	V
V_{EBO}	Emitter-base Voltage ($I_C = 0$)		7		V
I_C	Collector Current		9		A
I_{CM}	Collector Peak Current ($t_p < 5$ ms)		15		A
I_B	Base Current		8		A
I_{BM}	Base Peak Current ($t_p < 5$ ms)		10		A
		TO-3	TO-218	ISOWATT218	
P_{tot}	Total Dissipation at $T_C < 25^\circ C$	125	100	55	W
T_{stg}	Storage Temperature	- 65 to 175	- 65 to 150	- 65 to 150	$^\circ C$
T_J	Max. Operating Junction Temperature	175	150	150	$^\circ C$

THERMAL DATA

			TO-3	TO-218	ISOWATT218	
$R_{th\ j-case}$	Thermal Resistance Junction-case	max	1.2	1.25	2.27	°C/W

ELECTRICAL CHARACTERISTICS ($T_{case} = 25\text{ °C}$ unless otherwise specified)

Symbol	Parameter	Test Conditions	Min.	Typ.	Max.	Unit
I_{CER}	Collector Cutoff Current ($R_{BE} = 10\ \Omega$)	$V_{CE} = 850\text{ V}$ $V_{CE} = 850\text{ V}$ $T_{case} = 125\text{ °C}$			0.4 3	mA mA
I_{CEV}	Collector Cutoff Current ($V_{BE} = -2.5\text{ V}$)	$V_{CE} = 850\text{ V}$ $V_{CE} = 850\text{ V}$ $T_{case} = 125\text{ °C}$			0.15 1.5	mA mA
I_{EBO}	Emitter Cutoff Current ($I_C = 0$)	$V_{EB} = 5\text{ V}$			1	mA
$V_{CE(sus)}^*$	Collector-emitter Sustaining Voltage ($I_B = 0$)	$I_C = 0.2\text{ A}$ $L = 25\text{ mH}$ for BUX47/BUV47/BUV47FI for BUX47A/BUV47A/BUV47AFI	400 450			V V
V_{EBO}	Emitter-base Voltage ($I_C = 0$)	$I_E = 50\text{ mA}$	7		30	V
$V_{CE(sat)}^*$	Collector-emitter Saturation Voltage	for BUX47A/BUV47A/BUV47AFI $I_C = 5\text{ A}$ $I_B = 1\text{ A}$ $I_C = 8\text{ A}$ $I_B = 2.5\text{ A}$ for BUX47/BUV47/BUV47FI $I_C = 6\text{ A}$ $I_B = 1.2\text{ A}$ $I_C = 9\text{ A}$ $I_B = 3\text{ A}$			1.5 3	V V
$V_{BE(sat)}^*$	Base-emitter Saturation Voltage	for BUX47A/BUV47A/BUV47AFI $I_C = 5\text{ A}$ $I_B = 1\text{ A}$ for BUX47/BUV47/BUV47FI $I_C = 6\text{ A}$ $I_B = 1.2\text{ A}$			1.6 1.6	V V

RESISTIVE SWITCHING TIMES (see fig. 1)

Symbol	Parameter	Test Conditions	Min.	Typ.	Max.	Unit
t_{on}	Turn-on Time	for BUX47A/BUV47A/BUV47AFI			0.7	μs
t_s	Storage Time	$I_C = 5\text{ A}$ $V_{CC} = 150\text{ V}$			3	μs
t_f	Fall Time	$I_{B1} = -I_{B2} = 1\text{ A}$			0.8	μs
t_{on}	Turn-on Time	for BUX47/BUV47/BUV47FI			0.8	μs
t_s	Storage Time	$I_C = 6\text{ A}$ $V_{CC} = 150\text{ V}$			2.5	μs
t_f	Fall Time	$I_{B1} = -I_{B2} = 1.2\text{ A}$			0.8	μs

INDUCTIVE SWITCHING TIMES (see fig. 2)

Symbol	Parameter	Test Conditions	Min.	Typ.	Max.	Unit
t_f	Fall Time	$I_C = 5\text{ A}$ $I_{B1} = 1\text{ A}$ $V_{BE} = 5\text{ V}$ $V_{CC} = 300\text{ V}$ $L = 3\ \mu\text{H}$ $T_J = 100\text{ °C}$			0.5	μs

* Pulsed : pulse duration $\leq 300\ \mu\text{s}$, duty cycle $\leq 1.5\%$.

Safe Operating Areas (TO-3).

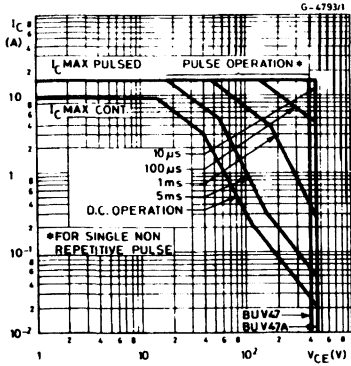

Safe Operating Areas (TO-218, ISOWATT218).

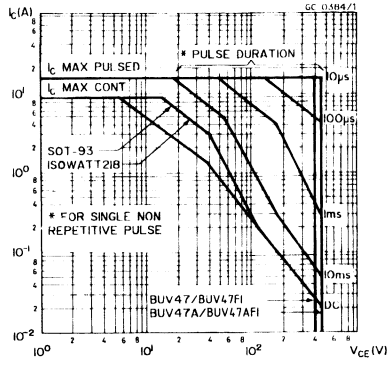

Clamped Reverse Bias Safe Operating Areas.

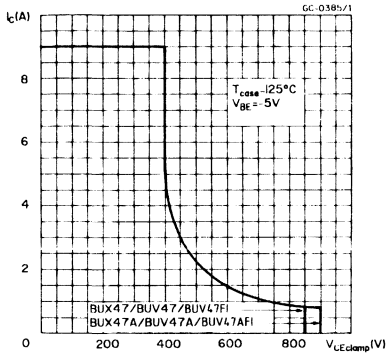

Forward Biased Accidental Overload Area (see fig. 3).

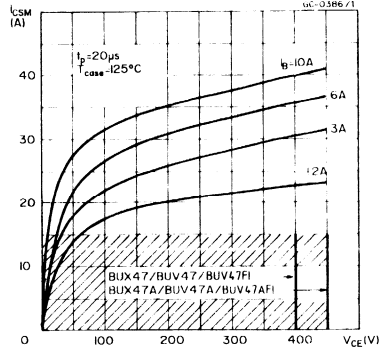

DC Current Gain.

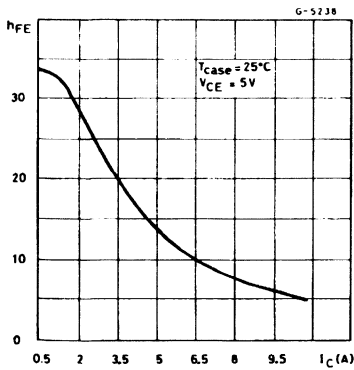

Saturation Voltage.

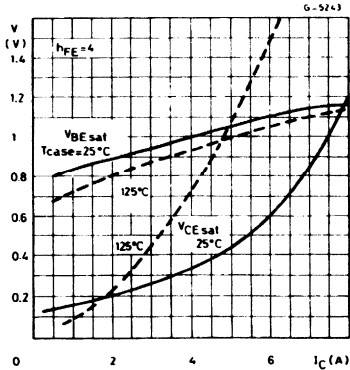

Collector-emitter Saturation Voltage.

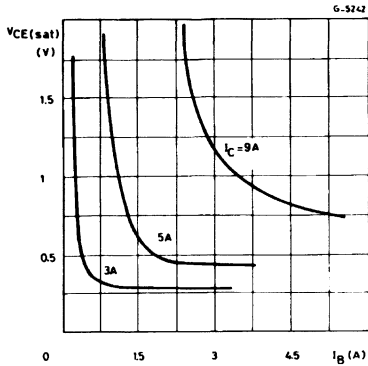

Collector Current Spread vs. Base Emitter Voltage.

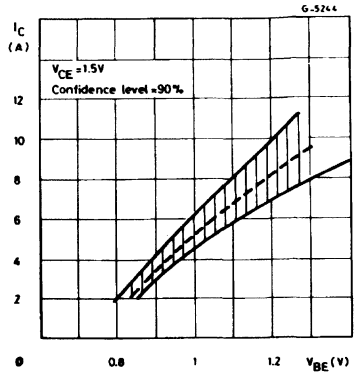

Switching Times Percentage Variation vs. Case Temperature.

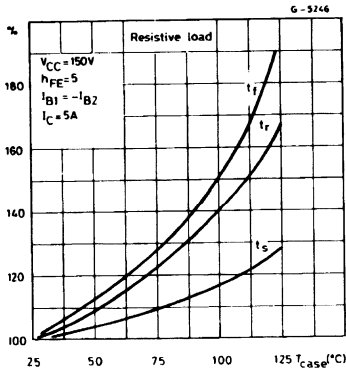

Switching Times Resistive Load (see fig. 1).

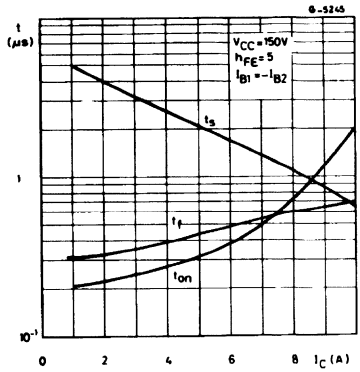

Switching Times Inductive Load (see fig. 2).

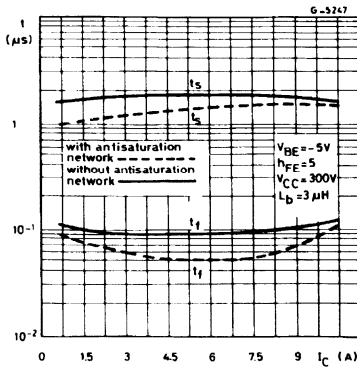

Switching Times Inductive Load vs. Case Temperature.

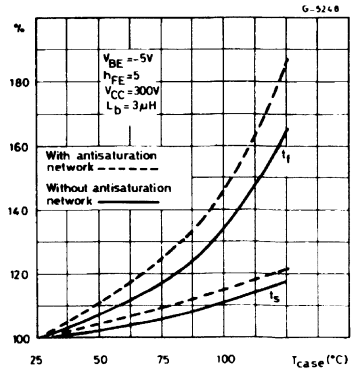

Fall Times vs. L_b (see fig. 2).

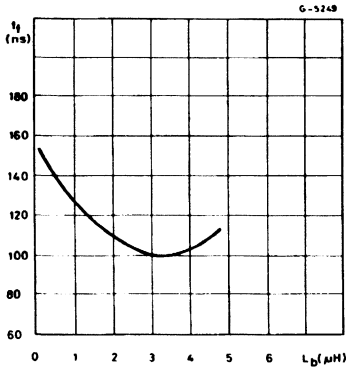

Dynamic Collector-emitter Saturation Voltage (see fig. 4).

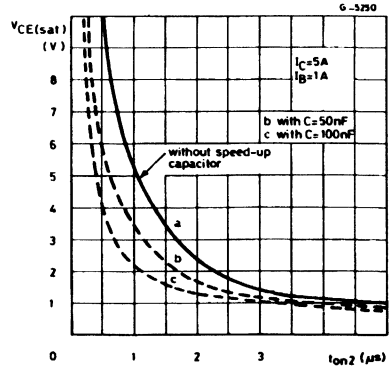

Figure 1 : Switching Times Test Circuit on Resistive Load.

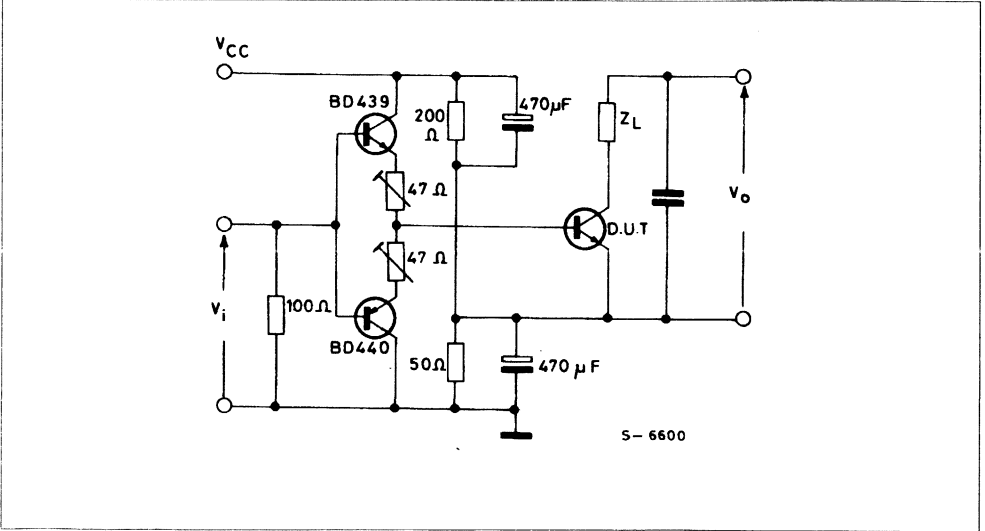

Figure 2 : Switching Times Test Circuit on Inductive Load. With and without Antisaturation Network.

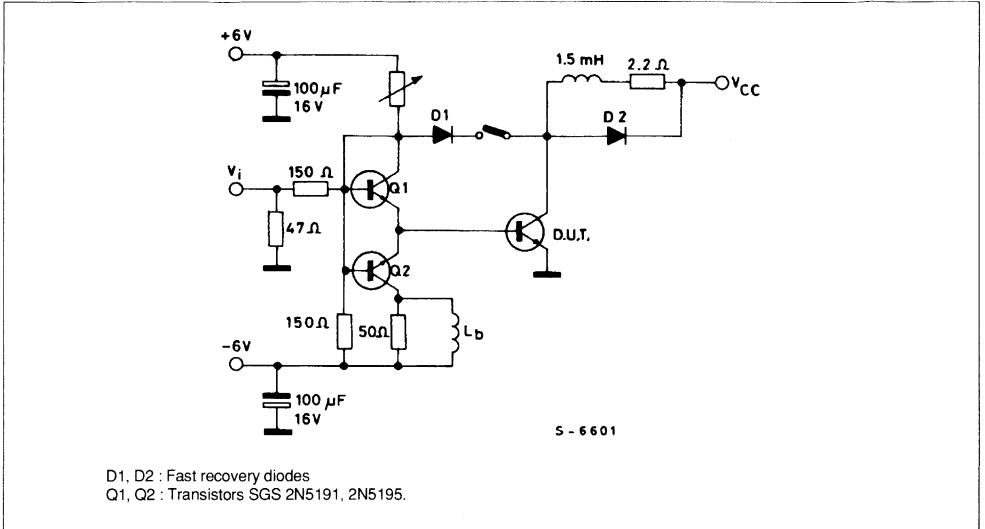

Figure 3 : Forward Biased Accidental Overload Area Test Circuit.

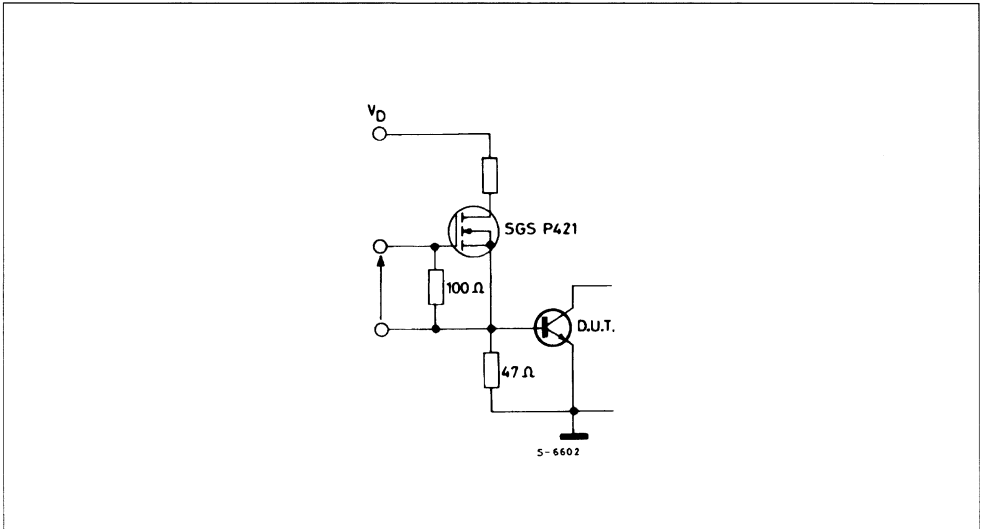

Figure 4 : $V_{CE(sat)}$ Dyn. Test Circuit.

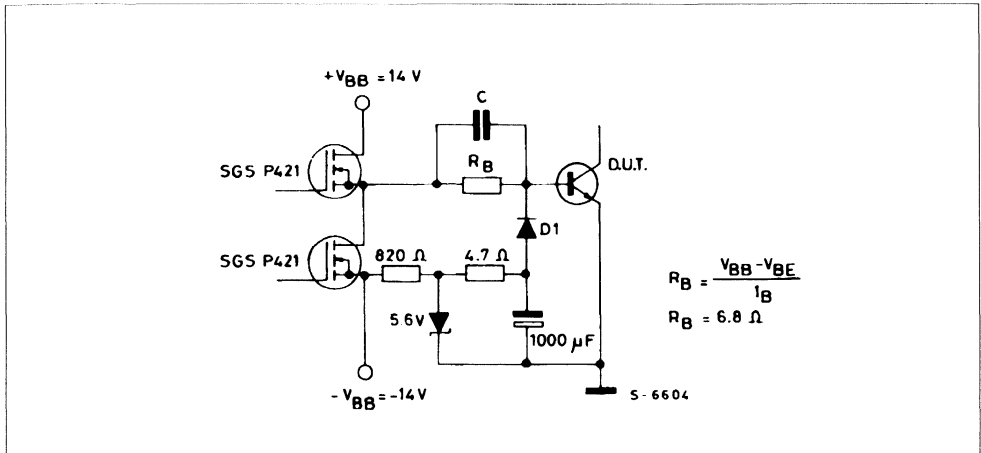

Figure 5 : Equivalent Input Schematic Circuit at Turn-on.

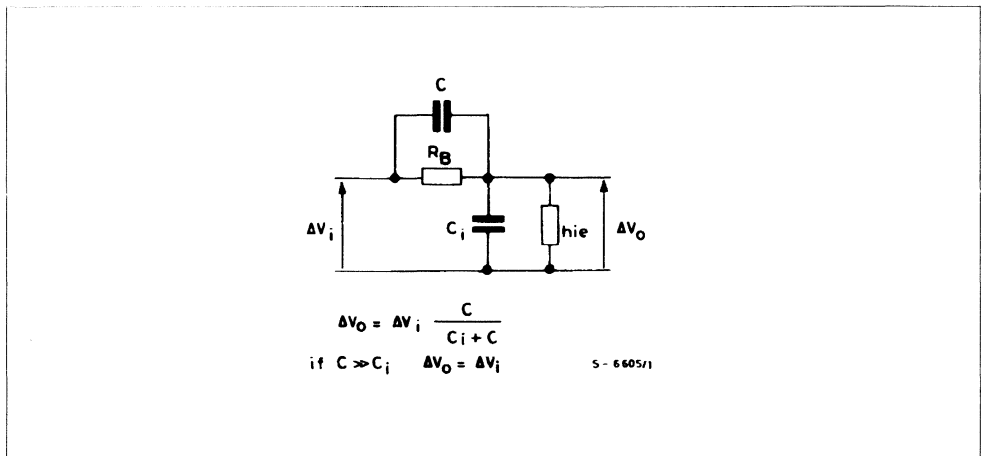
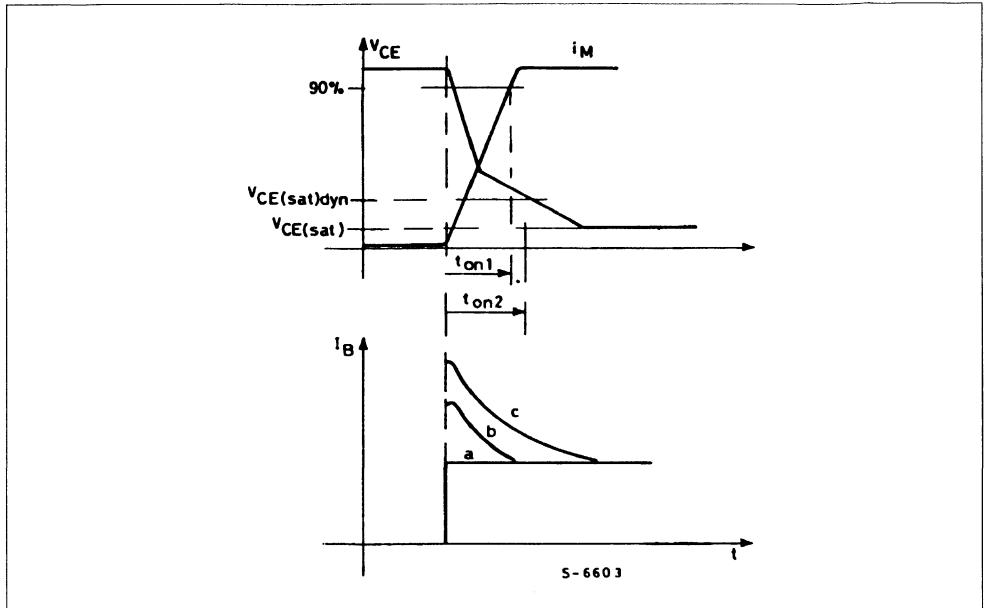

Figure 6 : Remarks to $V_{CE(sat)}$ Dyn. Test Circuit (fig. 4).



The speed-up capacitor decreases the $V_{CE(sat)}$ dyn. as shown in diagram (figure 6). The 50 nF capacitor modifies the shape of base current with a overshoot.

ISOWATT218 PACKAGE CHARACTERISTICS AND APPLICATION

ISOWATT218 is fully isolated to 4000V dc. Its thermal impedance, given in the data sheet, is optimized to give efficient thermal conduction together with excellent electrical isolation. The structure of the case ensures optimum distances between the pins and heatsink. These distances are in agreement with VDE and UL creepage and clearance standards. The ISOWATT218 package eliminates the need for external isolation so reducing fixing hardware.

The package is supplied with leads longer than the standard TO-218 to allow easy mounting on pcbs.

Accurate moulding techniques used in manufacture assures consistent heat spreader-to-heatsink capacitance.

ISOWATT218 thermal performance is equivalent to that of the standard part, mounted with a 0.1mm mica washer. The thermally conductive plastic has a higher breakdown rating and is less fragile than mica or plastic sheets. Power derating for ISOWATT218 packages is determined by :

$$P_D = \frac{T_J - T_c}{R_{th}}$$

THERMAL IMPEDANCE OF ISOWATT218 PACKAGE

Fig. 7 illustrates the elements contributing to the thermal resistance of a transistor heatsink assembly, using ISOWATT218 package.

The total thermal resistance $R_{th(tot)}$ is the sum of each of these elements. The transient thermal impedance, Z_{th} for different pulse durations can be estimated as follows :

1 - For a short duration power pulse of less than 1ms :

$$Z_{th} < R_{thJ-C}$$

2 - For an intermediate power pulse of 5ms to 50ms seconds :

$$Z_{th} = R_{thJ-C}$$

3 - For long power pulses of the order of 500ms seconds or greater :

$$Z_{th} = R_{thJ-C} + R_{thC-HS} + R_{thHS-amb}$$

It is often possible to discern these areas on transient thermal impedance curves.

Figure 7.

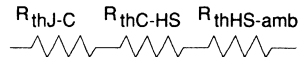

HIGH VOLTAGE POWER SWITCH

DESCRIPTION

The BUX48/A, BUV48/A, and BUV48FI/AFI are multiepitaxial mesa NPN transistors mounted respectively in TO-3 metal case, TO-218 plastic package and ISOWATT218 fully isolated package.

They are particularly intended for switching applications directly from the 220V and 380V mains.

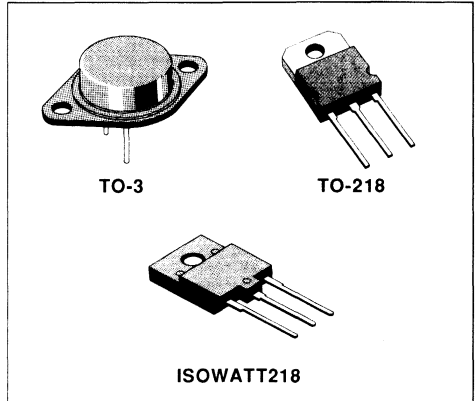

INTERNAL SCHEMATIC DIAGRAM

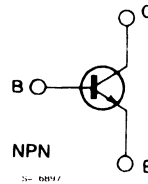

ABSOLUTE MAXIMUM RATINGS

Symbol	Parameter	Value			Unit
		BUX48 BUV48 BUX48FI	TO-218	BUX48A BUV48A BUX48AFI	
V_{CEr}	Collector-emitter Voltage ($R_{BE} = 10 \Omega$)	850		1000	V
V_{CEs}	Collector-emitter Voltage ($V_{BE} = 0$)	850		1000	V
V_{CE0}	Collector-emitter Voltage ($I_B = 0$)	400		450	V
V_{EBO}	Emitter-base Voltage ($I_C = 0$)	7			V
I_C	Collector Current	15			A
I_{CM}	Collector Peak Current ($t_p < 5$ ms)	30			A
I_{CP}	Collector Peak Current non Repetitive ($t_p < 20 \mu s$)	55			A
I_B	Base Current	4			A
I_{BM}	Base Peak Current	20			A
		TO-3	TO-218	ISOWATT218	
P_{tot}	Total Dissipation at $T_c < 25^\circ C$	175	125	65	W
T_{stg}	Storage Temperature	- 65 to 200	- 65 to 150	- 65 to 150	$^\circ C$
T_j	Max. Operating Junction Temperature	200	125	125	$^\circ C$

THERMAL DATA

			TO-3	TO-218	ISOWATT218	
$R_{th(j-case)}$	Thermal Resistance Junction-case	max	1	1	1.92	°C/W

ELECTRICAL CHARACTERISTICS ($T_{case} = 25\text{ °C}$ unless otherwise specified)

Symbol	Parameter	Test Conditions	Min.	Typ.	Max.	Unit
I_{CES}	Collector Cutoff Current ($V_{BE} = 0$)	$V_{CE} = \text{rated } V_{CES}$ $V_{CE} = \text{rated } V_{CES}, T_c = 125\text{ °C}$			200 2	μA mA
I_{CER}	Collector Cutoff Current ($R_{BE} = 10\ \Omega$)	$V_{CE} = \text{rated } V_{CER}$ $V_{CE} = \text{rated } V_{CER}, T_c = 125\text{ °C}$			500 4	μA mA
I_{EBO}	Emitter Cutoff Current ($I_C = 0$)	$V_{EB} = 5\text{ V}$			1	mA
$V_{CEO(sus)}$	Collector-emitter Sustaining Voltage ($I_B = 0$)	$I_C = 200\text{ mA}$ $L = 25\text{ mH}$ for BUX48/BUV48/BUV48FI for BUX48A/BUV48A/BUV48AFI	400 450			V V
V_{EBO}	Emitter-base Voltage ($I_C = 0$)	$I_E = 50\text{ mA}$	7		30	V
$V_{CE(sat)}^*$	Collector-emitter Saturation Voltage	for BUX48/BUV48/BUV48FI $I_C = 10\text{ A}$ $I_B = 2\text{ A}$ $I_C = 15\text{ A}$ $I_B = 4\text{ A}$ $I_C = 15\text{ A}$ $I_B = 3\text{ A}$ for BUX48A/BUV48A/BUV48AFI $I_C = 8\text{ A}$ $I_B = 1.6\text{ A}$ $I_C = 12\text{ A}$ $I_B = 2.4\text{ A}$			1.5 3.5 5 1.5 5	V V V V V
$V_{BE(sat)}$	Base-emitter Saturation voltage	for BUX48/BUV48/BUV48FI $I_C = 10\text{ A}$ $I_B = 2\text{ A}$ for BUX48A/BUV48A/BUV48AFI $I_C = 8\text{ A}$ $I_B = 1.6\text{ A}$			1.6 1.6	V V

* Pulsed : pulse duration = 300 μs , duty cycle $\leq 2\%$.

RESISTIVE SWITCHING TIMES (see fig. 2)

Symbol	Parameter	Test Conditions	Min.	Typ.	Max.	Unit
t_{on}	Turn-on Time	for BUX48/BUV48/BUV48FI $V_{CC} = 150\text{ V}$ $I_C = 10\text{ A}$ $I_{B1} = 2\text{ A}$ for BUX48A/BUV48A/BUV48AFI $V_{CC} = 150\text{ V}$ $I_C = 8\text{ A}$ $I_{B1} = 1.6\text{ A}$			1 1	μs μs
t_s	Storage Time	for BUX48/BUV48/BUV48FI $V_{CC} = 150\text{ V}$ $I_C = 10\text{ A}$ $I_{B1} = -I_{B2} = 2\text{ A}$ for BUX48A/BUV48A/BUV48AFI $V_{CC} = 150\text{ V}$ $I_C = 8\text{ A}$ $I_{B1} = -I_{B2} = 1.6\text{ A}$			3 3	μs μs
t_f	Fall Time	for BUX48/BUV48/BUV48FI $V_{CC} = 150\text{ V}$ $I_C = 10\text{ A}$ $I_{B1} = -I_{B2} = 2\text{ A}$ for BUX48A/BUV48A/BUV48AFI $V_{CC} = 150\text{ V}$ $I_C = 8\text{ A}$ $I_{B1} = -I_{B2} = 1.6\text{ A}$			0.8 0.8	μs μs

INDUCTIVE SWITCHING TIMES (see fig. 1)

Symbol	Parameter	Test Conditions	Min.	Typ.	Max.	Unit
t_s	Storage Time	for BUX48/BUV48/BUV48FI $V_{CC} = 300\text{ V}$, $I_C = 10\text{ A}$, $L_B = 3\text{ }\mu\text{H}$ $V_{BE} = -5\text{ V}$, $I_{B1} = 2\text{ A}$ same $T_{case} = 125\text{ }^\circ\text{C}$		2.7	5	μs μs
		for BUX48A/BUV48A/BUV48AFI $V_{CC} = 300\text{ V}$, $I_C = 8\text{ A}$, $L_B = 3\text{ }\mu\text{H}$ $V_{BE} = -5\text{ V}$, $I_{B1} = 1.6\text{ A}$ same, $T_{case} = 125\text{ }^\circ\text{C}$		3	5	μs μs
t_f	Fall Time	for BUX48/BUV48/BUV48FI $V_{CC} = 300\text{ V}$, $I_C = 10\text{ A}$, $L_B = 3\text{ }\mu\text{H}$ $V_{BE} = -5\text{ V}$, $I_{B1} = 2\text{ A}$ same $T_{case} = 125\text{ }^\circ\text{C}$		0.16	0.4	μs μs
		for BUX48A/BUV48A/BUV48AFI $V_{CC} = 300\text{ V}$, $I_C = 8\text{ A}$, $L_B = 3\text{ }\mu\text{H}$ $V_{BE} = -5\text{ V}$, $I_{B1} = 1.6\text{ A}$ same, $T_{case} = 125\text{ }^\circ\text{C}$		0.13	0.4	μs μs

Safe Operating Area (TO-3).

Safe Operating Area (TO-218, ISOWATT218).

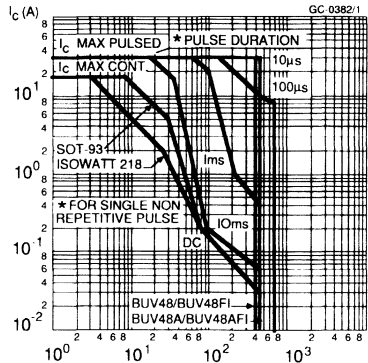
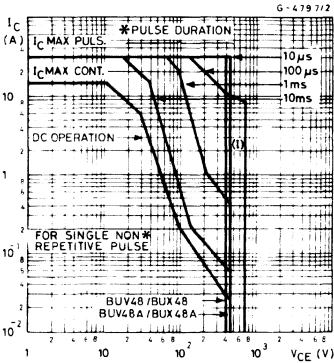

Clamped Reverse Bias Safe Operating Areas.

Forward Biased Accidental Overload Area.
(see fig. 3).

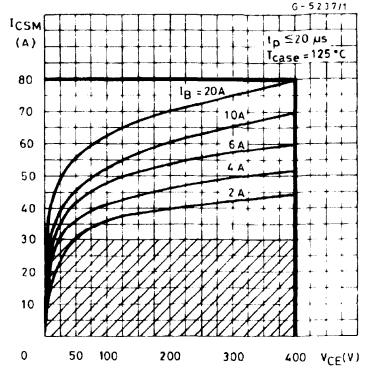
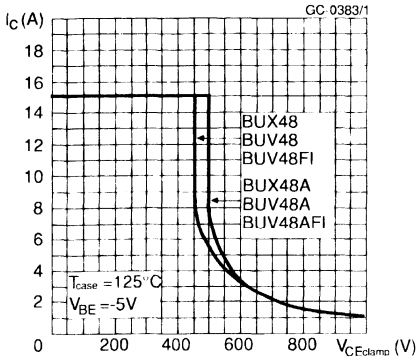

DC Current Gain..

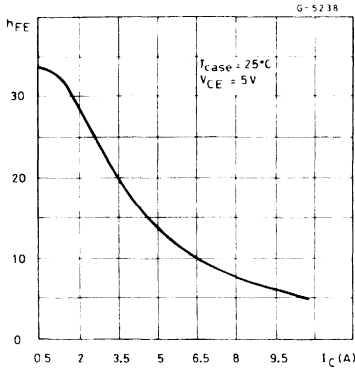

Saturation Voltage.

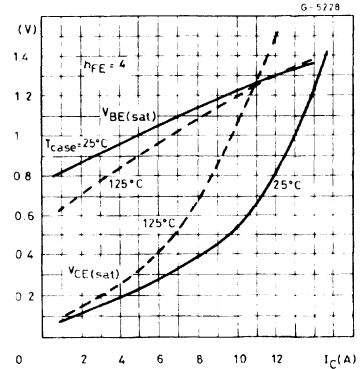

Collector-emitter Saturation Voltage.

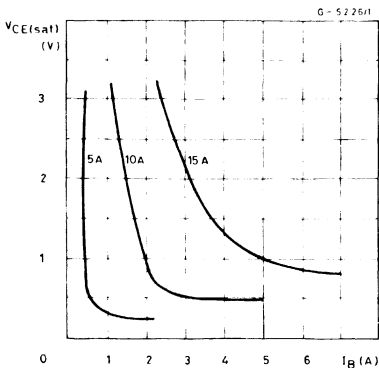

Collector Current Spread vs. Base Emitter Voltage.

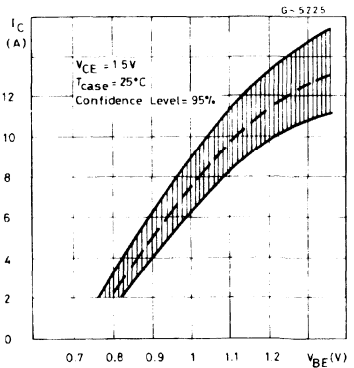

Switching Times vs. Collector Current with I_B Constant.

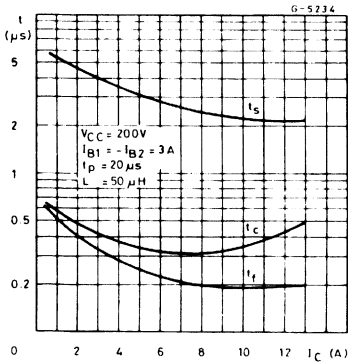

Switching Times Percentage Variation vs. Case Temperature.

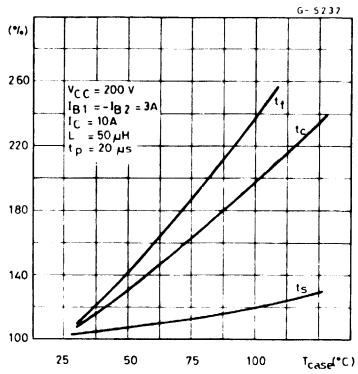

Switching Times with and without Antisaturation Network (see fig.1).

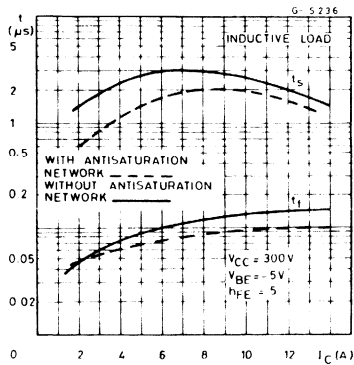

Switching Times Percentage Variation vs. Case Temperature.

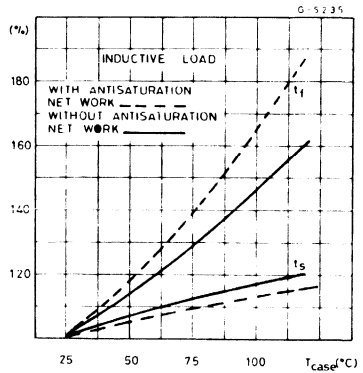

Switching Times vs. Collector Current (see fig.2).

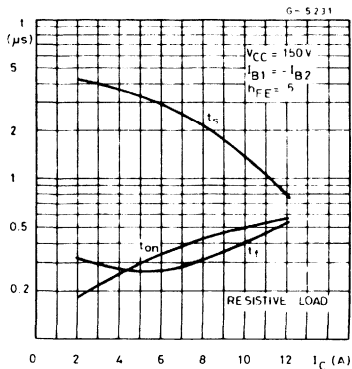

Fall Times vs. Voltage Slope (see fig.2).

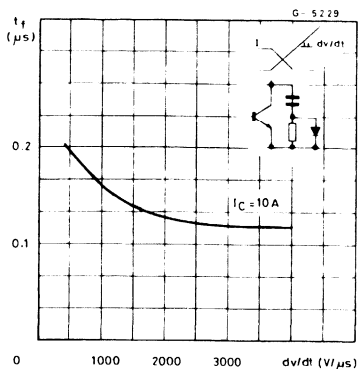

Switching Times Percentage Variation vs. Case Temperature.

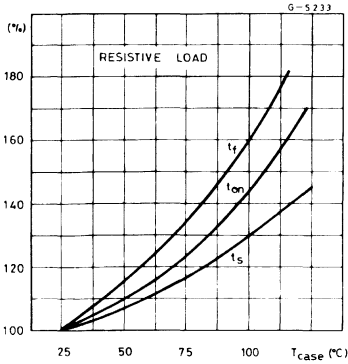

Dynamic Collector-emitter Saturation Voltage (see fig. 4).

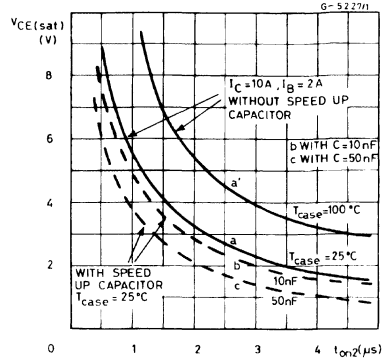

Figure 1 : Switching Times Test Circuit on Inductive Load, with and without Antisaturation Network.

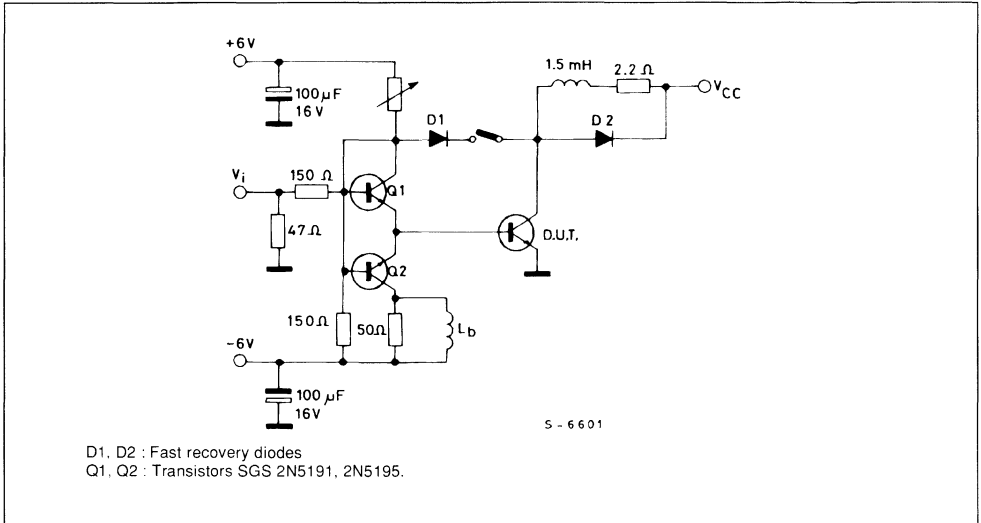

Figure 2 : Switching Times Test Circuit on resistive Load.

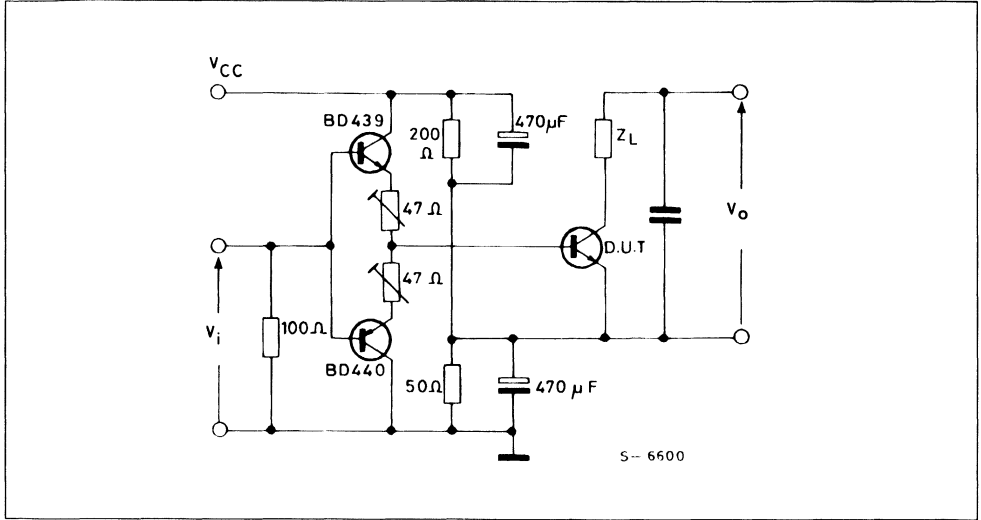

Figure 3 : Forward Biased Accidental Overload Area Test Circuit.

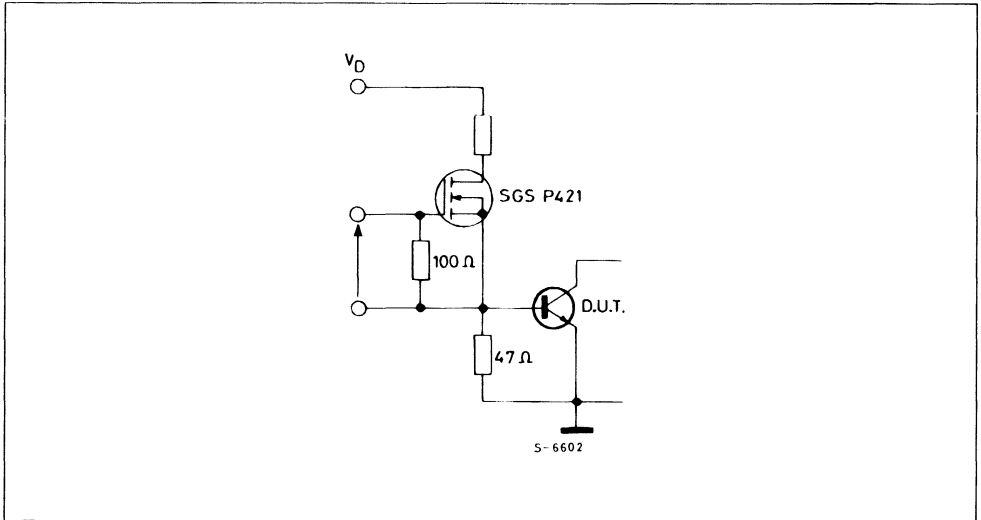

Figure 4 : $V_{CE(sat)}$ Dyn. Test Circuit.

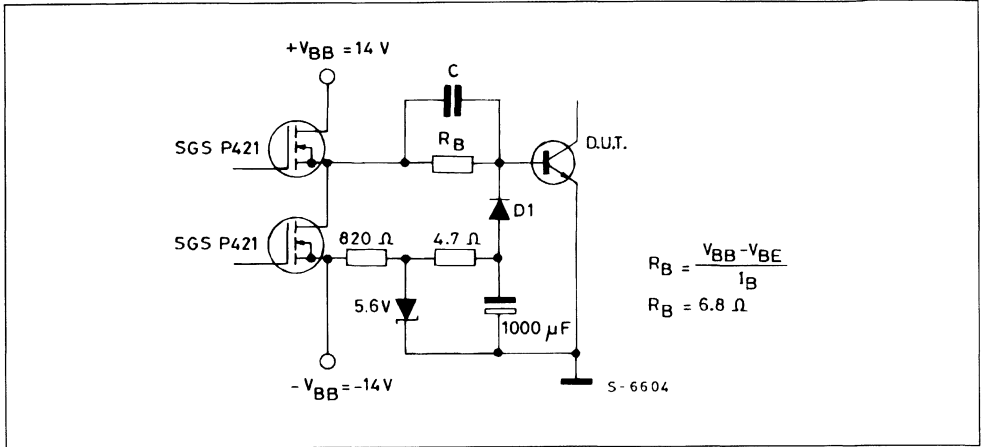

Figure 5 : Equivalent Input Schematic Circuit at Turn-on.

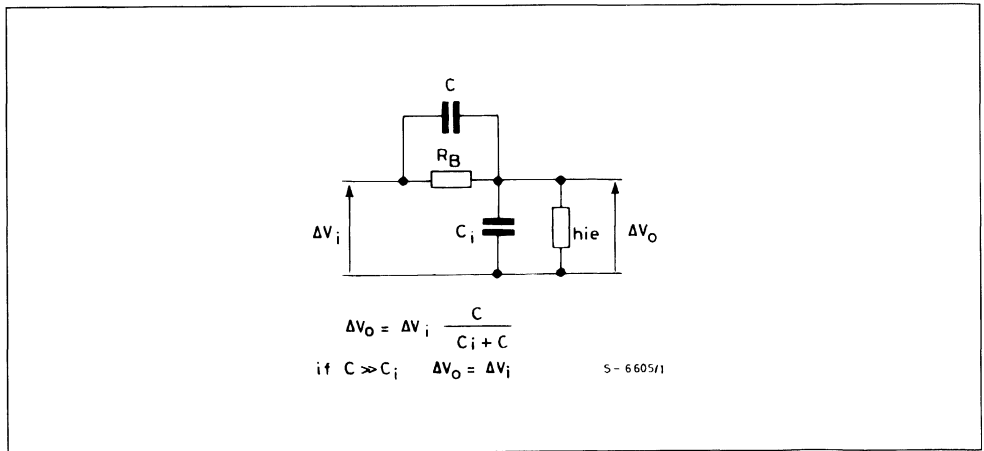
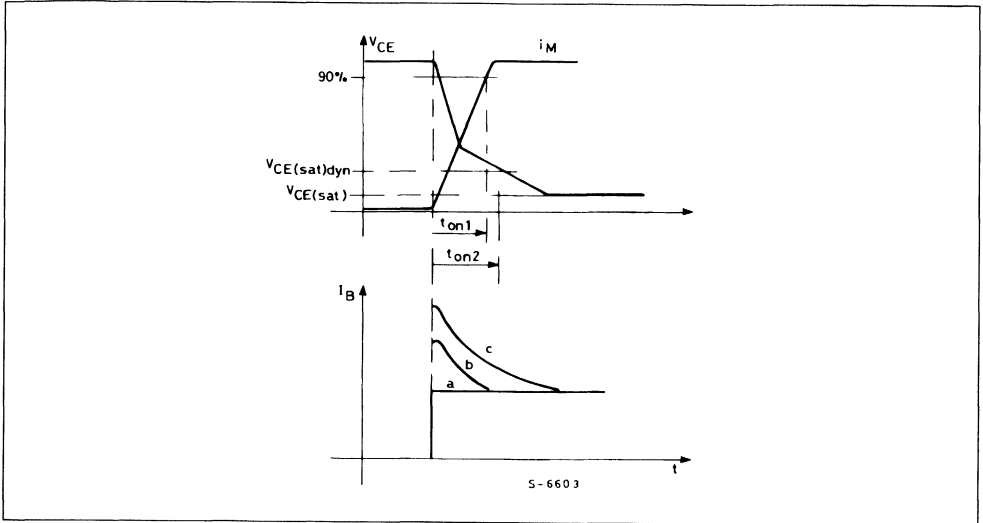

Figure 6 : Remarks to $V_{CE(sat)}$ Dyn. Test Circuit (fig.4).



The speed-up capacitor decreases the $V_{CE(sat)}$ dyn. as shown in diagram (figure 6). The 50 nF capacitor modifies the shape of base current with a overshoot.

ISOWATT218 PACKAGE CHARACTERISTICS AND APPLICATION

ISOWATT218 is fully isolated to 4000V dc. Its thermal impedance, given in the data sheet, is optimised to give efficient thermal conduction together with excellent electrical isolation. The structure of the case ensures optimum distances between the pins and heatsink. These distances are in agreement with VDE and UL creepage and clearance standards. The ISOWATT218 package eliminates the need for external isolation so reducing fixing hardware.

The package is supplied with leads longer than the standard TO-218 to allow easy mounting on pcbs.

Accurate moulding techniques used in manufacture assures consistent heat spreader-to-heatsink capacitance.

ISOWATT218 thermal performance is equivalent to that of the standard part, mounted with a 0.1 mm mica washer. The thermally conductive plastic has a higher breakdown rating and is less fragile than mica or plastic sheets. Power derating for ISOWATT218 packages is determined by :

$$P_D = \frac{T_j - T_c}{R_{th}}$$

THERMAL IMPEDANCE OF ISOWATT218 PACKAGE

Figure 6 illustrates the elements contributing to the thermal resistance of a transistor heatsink assembly, using ISOWATT218 package.

The total thermal resistance $R_{th(tot)}$ is the sum of each of these elements. The transient thermal impedance, Z_{th} for different pulse durations can be estimated as follows :

1 - For a short duration power pulse of less than 1ms :

$$Z_{th} < R_{thJ-C}$$

2 - For an intermediate power pulse of 5ms to 50ms seconds :

$$Z_{th} = R_{thJ-C}$$

3 - For long power pulses of the order of 500ms seconds or greater :

$$Z_{th} = R_{thJ-C} + R_{thC-HS} + R_{thHS-amb}$$

It is often possible to discern these areas on transient thermal impedance curves.

Figure 6.

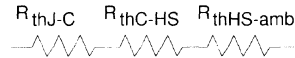

HIGH VOLTAGE POWER SWITCHING

DESCRIPTION

The BUX48B/C, BUV48B/C and BUV48BFI/CFI are silicon multi-epitaxial mesa NPN transistors mounted respectively in TO-3 metal case, TO-218 plastic package and ISOWATT218 fully isolated package. They are particularly intended for switching and industrial applications from single and three-phase mains.

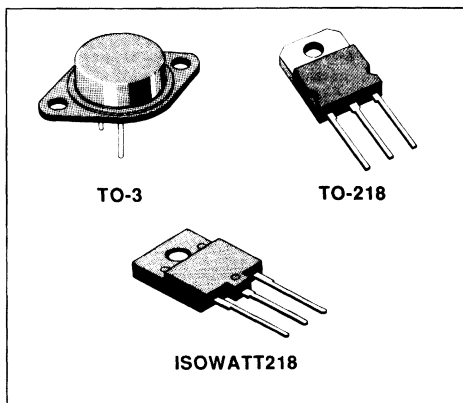

INTERNAL SCHEMATIC DIAGRAM

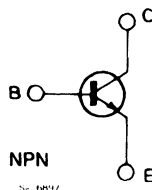

ABSOLUTE MAXIMUM RATINGS

Symbol	Parameter	Value			Unit
		BUX48B BUV48B BUV48BFI	TO-218	BUX48C BUV48C BUV48CFI	
V_{CEr}	Collector-emitter Voltage ($R_{BE} = 10\Omega$)	1200		1200	V
V_{CES}	Collector-emitter Voltage ($V_{BE} = 0$)	1200		1200	V
V_{CEO}	Collector-emitter Voltage ($I_B = 0$)	600		700	V
V_{EBO}	Emitter-base Voltage ($I_C = 0$)		7		V
I_C	Collector Current		15		A
I_{CM}	Collector Peak Current ($t_p < 5ms$)		30		A
I_{CP}	Collector Peak Current non Repetitive ($t_p < 20\mu s$)		55		A
I_B	Base Current		4		A
I_{BM}	Base Peak Current ($t_p < 5ms$)		20		A
		TO-3	TO-218	ISOWATT218	
P_{Tot}	Total Dissipation at $T_c < 25^\circ C$	175	125	65	W
T_{stg}	Storage Temperature	- 65 to 200	- 65 to 150	- 65 to 150	$^\circ C$
T_j	Max. Operating Junction Temperature	200	150	150	$^\circ C$

THERMAL DATA

			TO-3	TO-218	ISOWATT218	
$R_{th(j-case)}$	Thermal Resistance Junction-case	max	1	1	1.92	°C/W

ELECTRICAL CHARACTERISTICS ($T_{case} = 25\text{ °C}$ unless otherwise specified)

Symbol	Parameter	Test Conditions	Min.	Typ.	Max.	Unit
I_{CER}	Collector Cutoff Current ($R_{BE} = 10\ \Omega$)	$V_{CE} = 1200\text{ V}$ $V_{CE} = 1200\text{ V}$ $T_{case} = 125\text{ °C}$			500 4	μA mA
I_{CES}	Collector Cutoff Current ($V_{BE} = 0$)	$V_{CE} = 1200\text{ V}$ $V_{CE} = 1200\text{ V}$ $T_{case} = 125\text{ °C}$			500 3	μA mA
I_{CEO}	Collector Cutoff Current ($I_B = 0$)	$V_{CE} = V_{CEO}$			1	mA
I_{EBO}	Emitter Cutoff Current ($I_C = 0$)	$V_{EB} = 6\text{ V}$			1	mA
$V_{CEO(sus)}^*$	Collector-emitter Sustaining Voltage ($I_B = 0$)	$I_C = 100\text{ mA}$ for BUX48B/BUV48B/BUV48BFI for BUX48C/BUV48C/BUV48CFI	600 700			V
$V_{CER(sus)}^*$	Collector-emitter Sustaining Voltage ($R_{BE} = 10\ \Omega$)	$I_C = 0.5\text{ A}$ $L = 2\text{ mH}$ $V_{clamp} = 1200\text{ V}$	1200			V
$V_{CE(sat)}^*$	Collector-emitter Saturation Voltage	$I_C = 6\text{ A}$ $I_B = 1.5\text{ A}$ $I_C = 10\text{ A}$ $I_B = 4\text{ A}$			1.5 3	V V
$V_{BE(sat)}^*$	Base-emitter Saturation Voltage	$I_C = 6\text{ A}$ $I_B = 1.5\text{ A}$ $I_C = 10\text{ A}$ $I_B = 4\text{ A}$			1.5 2	V V

* Pulsed : pulse duration = 300 μs , duty cycle = 1.5 %.

RESISTIVE SWITCHING TIMES

Symbol	Parameter	Test Conditions	Min.	Typ.	Max.	Unit
t_{on}	Turn-on Time	$V_{CC} = 250\text{ V}$ $I_C = 6\text{ A}$ $I_{B1} = -I_{B2} = 1.5\text{ A}$		0.5	1	μs
t_s	Storage Time			1.5	3	μs
t_f	Fall Time			0.2	0.7	μs

INDUCTIVE SWITCHING TIMES

Symbol	Parameter	Test Conditions	Min.	Typ.	Max.	Unit
t_s	Storage Time	$V_{CC} = 250\text{ V}$ $I_C = 6\text{ A}$ $I_{B1} = -I_{B2} = 1.5\text{ A}$		2		μs
t_f	Fall Time			0.15		μs
t_s	Storage Time	$V_{CC} = 250\text{ V}$ $I_C = 6\text{ A}$ $I_{B1} = -I_{B2} = 1.5\text{ A}$ $T_C = 125\text{ °C}$		3	6	μs
t_f	Fall Time			0.33	0.60	μs

Safe Operating Areas (TO-3).

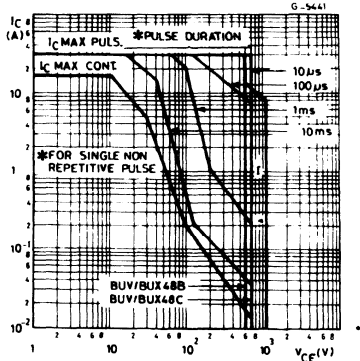

I - Area of permissible operation during turn-on provided $R_{BE} \leq 100 \Omega$ and $t_p \leq 0.2 \mu s$.

DC Current Gain.

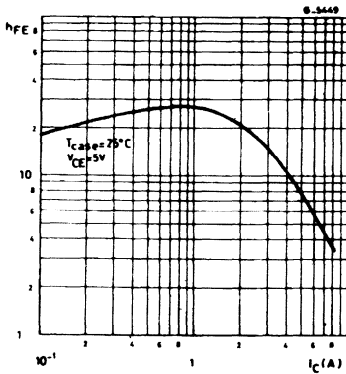

Collector Current Spread vs. Base Emitter Voltage.

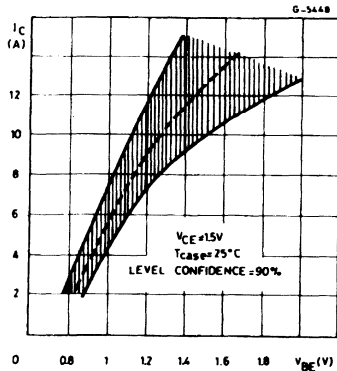

Safe Operating Areas (TO-218, ISOWATT218).

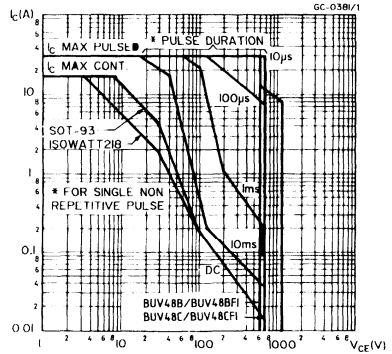

Collector-emitter Saturation Voltage.

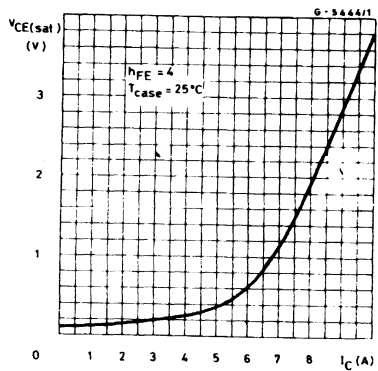

Minimum Bias Current I_{BD} to Saturate the Discrete darlington.

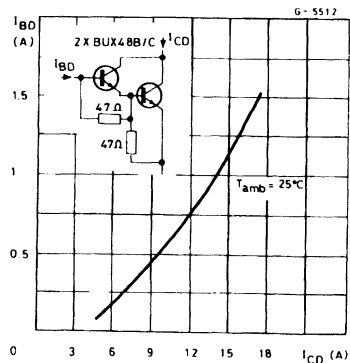

Minimum Base Current I_{BD} to Saturate the Discrete Darlington.

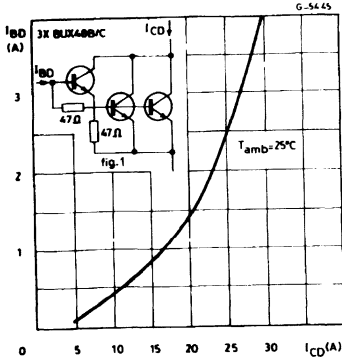

DC Current Gain for Darlington Configuration (see fig. 1).

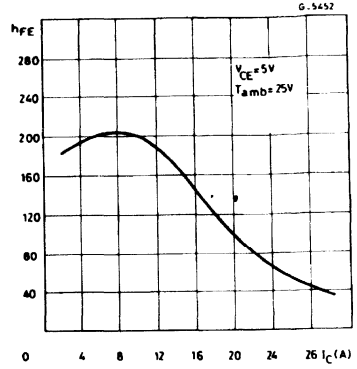

Switching Times Resistive Load.

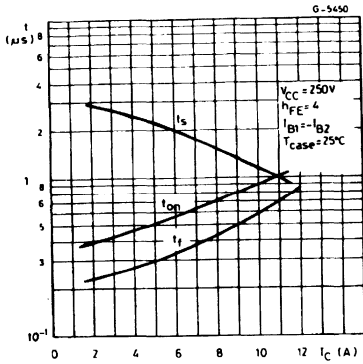

Switching Times Percentage Variation vs. Case Temperature.

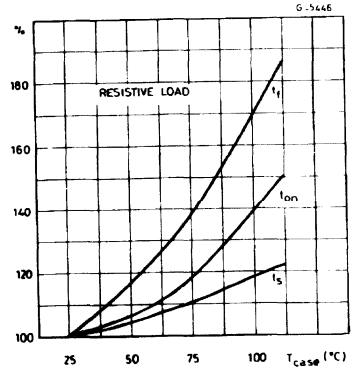

Switching Times Inductive Load.

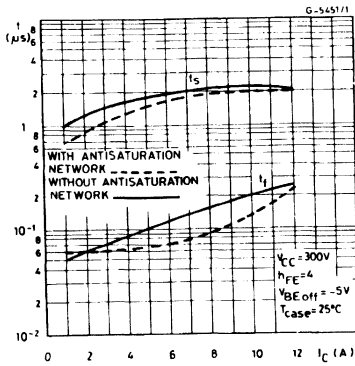

Switching Times Percentage Variation vs. Case Temperature.

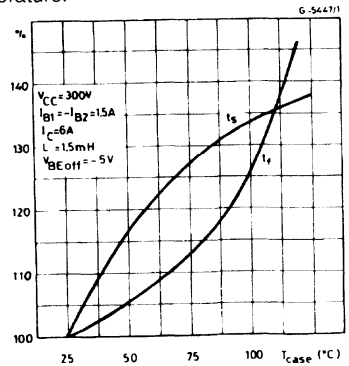

Forward Biased Accidental Overload Area.

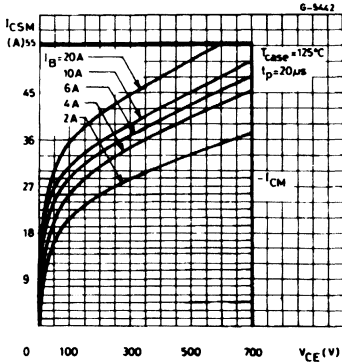

Clamped Reverse Biased Safe Operating.

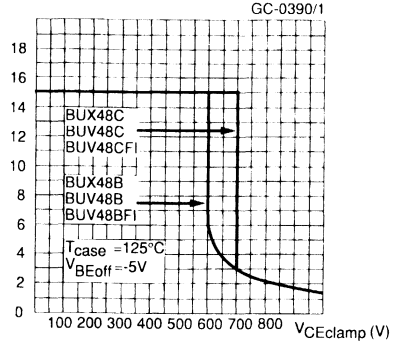

TEST CIRCUITS

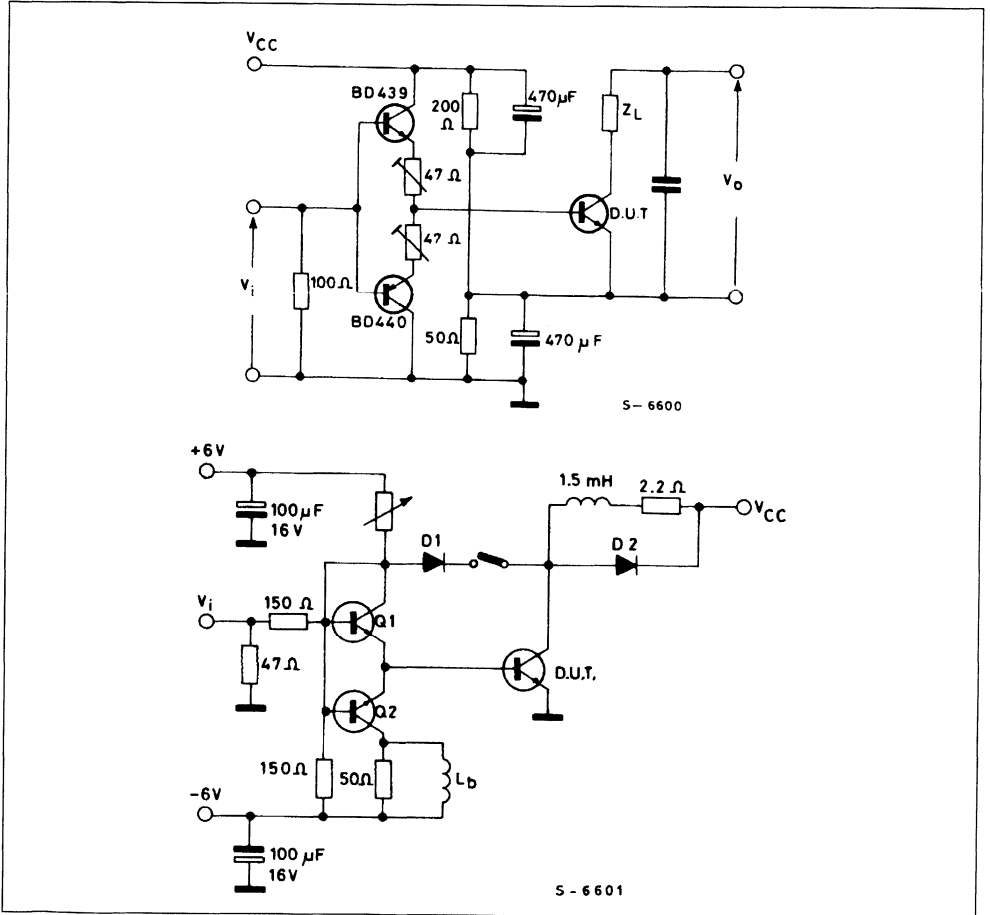

ISOWATT218 PACKAGE CHARACTERISTICS AND APPLICATION

ISOWATT218 is fully isolated to 4000V dc. Its thermal impedance, given in the data sheet, is optimised to give efficient thermal conduction together with excellent electrical isolation. The structure of the case ensures optimum distances between the pins and heatsink. These distances are in agreement with VDE and UL creepage and clearance standards. The ISOWATT218 package eliminates the need for external isolation so reducing fixing hardware.

The package is supplied with leads longer than the standard TO-218 to allow easy mounting on pcbs.

Accurate moulding techniques used in manufacture assures consistent heat spreader-to-heatsink capacitance.

ISOWATT218 thermal performance is equivalent to that of the standard part, mounted with a 0.1mm mica washer. The thermally conductive plastic has a higher breakdown rating and is less fragile than mica or plastic sheets. Power derating for ISOWATT218 packages is determined by :

$$P_D = \frac{T_j - T_c}{R_{th}}$$

THERMAL IMPEDANCE OF ISOWATT218 PACKAGE

Figure 1 illustrates the elements contributing to the thermal resistance of a transistor heatsink assembly, using ISOWATT218 package.

The total thermal resistance $R_{th(tot)}$ is the sum of each of these elements. The transient thermal impedance, Z_{th} for different pulse durations can be estimated as follows :

1 - For a short duration power pulse of less than 1ms :

$$Z_{th} < R_{thJ-C}$$

2 - For an intermediate power pulse of 5ms to 50ms seconds :

$$Z_{th} = R_{thJ-C}$$

3 - For long power pulses of the order of 500ms seconds or greater :

$$Z_{th} = R_{thJ-C} + R_{thC-HS} + R_{thHS-amb}$$

It is often possible to discern these areas on transient thermal impedance curves.

Figure 1.

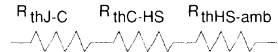

HIGH VOLTAGE POWER SWITCH

DESCRIPTION

The BUX80 is a silicon multi-epitaxial mesa NPN transistor in Jedec TO-3 metal case, particularly intended for converters, inverters, switching regulators and motor control systems applications.

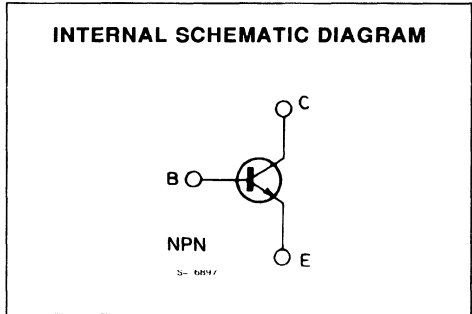
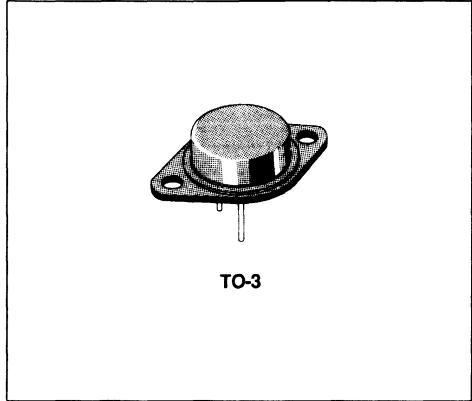

ABSOLUTE MAXIMUM RATINGS

Symbol	Parameter	Value	Unit
V_{CES}	Collector-emitter Voltage ($V_{BE} = 0$)	800	V
V_{CER}	Collector-emitter Voltage ($R_{BE} = 50 \Omega$)	500	V
V_{CEO}	Collector-emitter Voltage ($I_B = 0$)	400	V
V_{EBO}	Emitter-base Voltage ($I_C = 0$)	10	V
I_C	Collector Current	10	A
I_{CM}	Collector Peak Current	15	A
I_B	Base Current	5	A
P_{tot}	Total Power Dissipation at $T_{case} \leq 40^\circ C$	100	W
T_{stg}	Storage Temperature	- 65 to 150	$^\circ C$
T_j	Junction Temperature	150	$^\circ C$

THERMAL DATA

$R_{th\ j-case}$	Thermal Resistance Junction-case	Max	1.1	°C/W
------------------	----------------------------------	-----	-----	------

ELECTRICAL CHARACTERISTICS ($T_{case} = 25\text{ °C}$ unless otherwise specified)

Symbol	Parameter	Test Conditions	Min.	Typ.	Max.	Unit
I_{CES}	Collector Cutoff Current ($V_{BE} = 0$)	$V_{CE} = 800\text{ V}$ $V_{CE} = 800\text{ V}$ $T_{case} = 125\text{ °C}$			1 3	mA mA
I_{EBO}	Emitter Cutoff Current ($I_C = 0$)	$V_{EB} = 10\text{ V}$			10	mA
$V_{CE0(sus)*}$	Collector-emitter Sustaining Voltage ($I_B = 0$)	$I_C = 100\text{ mA}$	400			V
$V_{CER(sus)*}$	Collector-emitter Sustaining Voltage ($R_{BE} = 50\ \Omega$)	$I_C = 100\text{ mA}$	500			V
$V_{CE(sat)*}$	Collector-emitter Saturation Voltage	$I_C = 5\text{ A}$ $I_B = 1\text{ A}$ $I_C = 8\text{ A}$ $I_B = 2.5\text{ A}$			1.5 3	V V
$V_{BE(sat)*}$	Base-emitter Saturation Voltage	$I_C = 5\text{ A}$ $I_B = 1\text{ A}$ $I_C = 8\text{ A}$ $I_B = 2.5\text{ A}$			1.4 1.8	V V
$h_{FE}*$	DC Current Gain	$I_C = 1.2\text{ A}$ $V_{CE} = 5\text{ V}$		30		
t_{on}	Turn-on Time	$I_C = 5\text{ A}$ $V_{CC} = 250\text{ V}$ $I_{B1} = 1\text{ A}$			0.5	μs
t_s	Storage Time	$I_C = 5\text{ A}$ $I_{B1} = 1\text{ A}$ $I_{B2} = -2\text{ A}$ $V_{CC} = 250\text{ V}$			3.5	μs
t_f	Fall Time	$I_C = 5\text{ A}$ $I_{B1} = 1\text{ A}$ $I_{B2} = -2\text{ A}$ $V_{CC} = -250\text{ V}$			0.5	μs

* Pulsed : pulse duration = 300 μs , duty cycle = 1.5 %.

Safe Operating Areas.

Derating Curves.

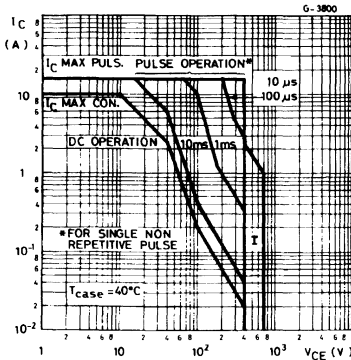

I - Area of permissible operation during Turn-on provided $R_{BE} \leq 100\ \Omega$ and $t_b \leq 0.6\ \mu\text{s}$.

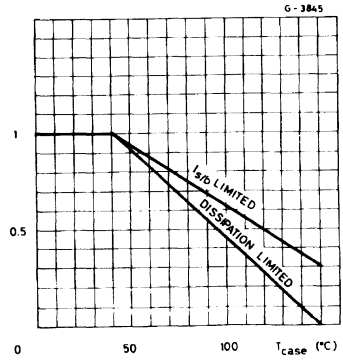

Transient Thermal Response.

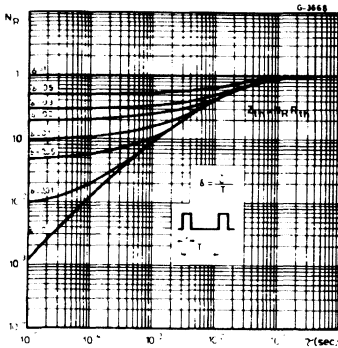

DC Current Gain.

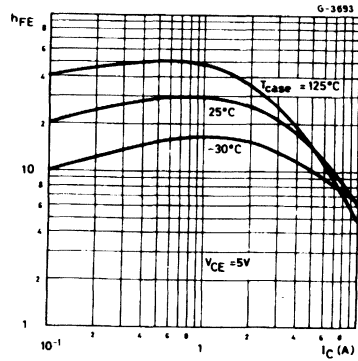

Collector-emitter Saturation Voltage.

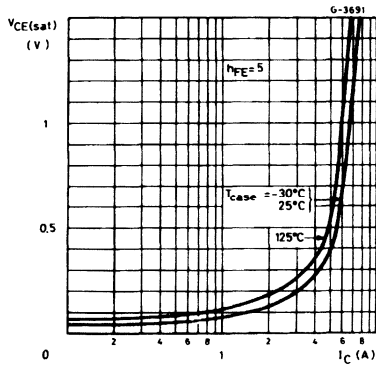

Collector-emitter Saturation Voltage.

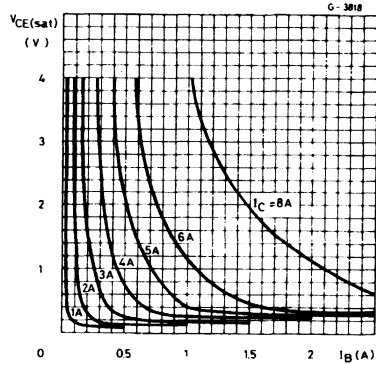

Base-emitter Saturation Voltage.

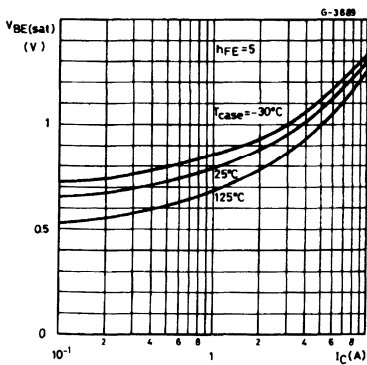

Saturated Switching Characteristics.

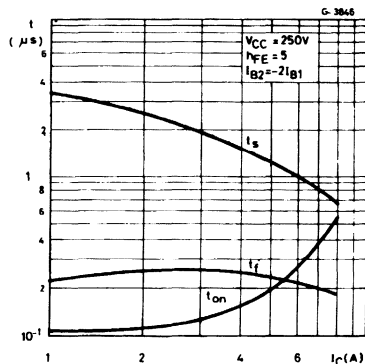

Saturated Switching Characteristics.

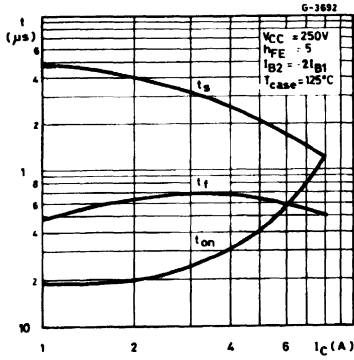

Saturated Switching Characteristics.

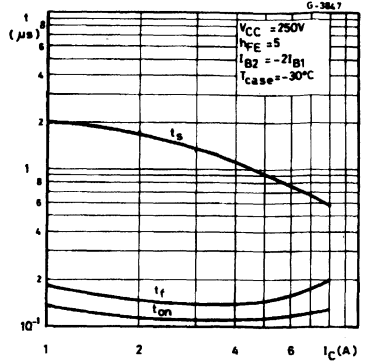

Clamped Reverse Bias Safe Operating Areas.

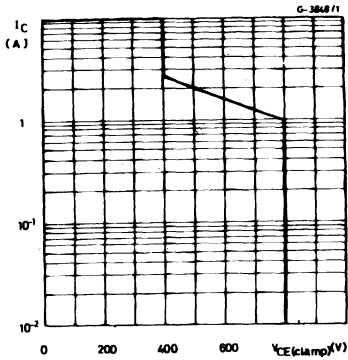

Clamped E_{sb} Test Circuit.

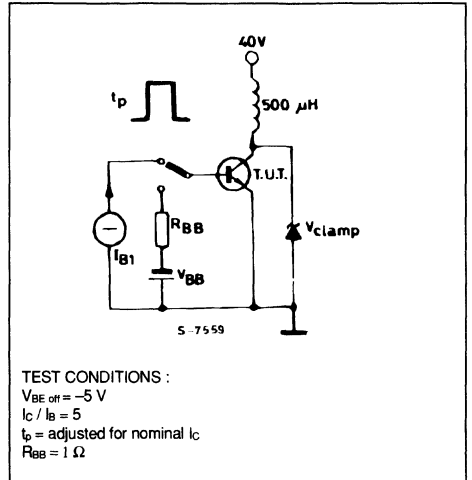

HIGH VOLTAGE SWITCH

DESCRIPTION

The BUX84, and BUX84A are multi-epitaxial mesa NPN transistors, intended for use in converters inverters, switching regulators, motor control system and switching applications. They are mounted in Je-dec TO-220 plastic package.

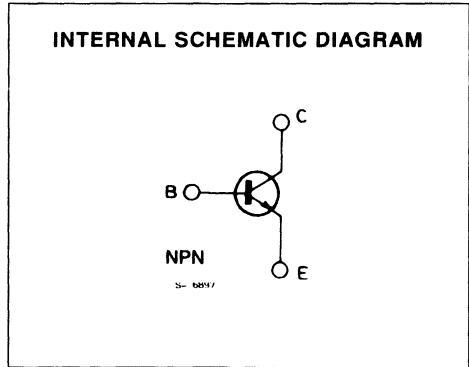
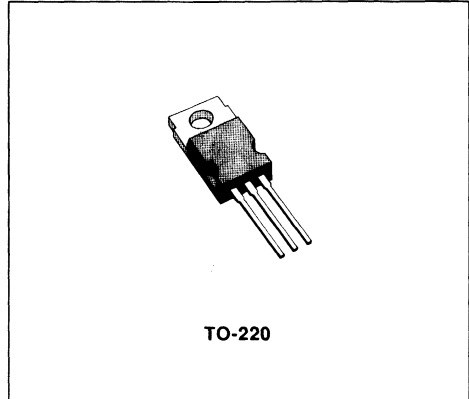

ABSOLUTE MAXIMUM RATINGS

Symbol	Parameter	Value	Unit
V_{CES}	Collector-emitter Voltage ($V_{BE} = 0$)	800	V
V_{CEO}	Collector-emitter Voltage ($I_B = 0$)	400	V
I_C	Collector Current	2	A
I_{CM}	Collector Peak Current	3	A
I_B	Base Current	0.75	A
P_{tot}	Total Power Dissipation at $T_{case} \leq 25\text{ }^\circ\text{C}$	40	W
T_{stg}	Storage Temperature	- 65 to 150	$^\circ\text{C}$
T_j	Junction Temperature	150	$^\circ\text{C}$

THERMAL DATA

$R_{th\ j-case}$	Thermal Resistance Junction-case	Max	3.125	$^{\circ}C/W$
------------------	----------------------------------	-----	-------	---------------

ELECTRICAL CHARACTERISTICS ($T_{case} = 25\ ^{\circ}C$ unless otherwise specified)

Symbol	Parameter	Test Conditions	Min.	Typ.	Max.	Unit
I_{EBO}	Emitter Cutoff Current ($I_C = 0$)	$V_{EB} = 5\ V$			1	mA
I_{CES}	Collector Cutoff Current ($V_{BE} = 0$)	$V_{CE} = \text{rated } V_{CES}$ at $T_{case} = 125\ ^{\circ}C$			0.2 1.5	mA mA
$V_{CE(sat)}^*$	Collector-emitter Saturation Voltage	$I_C = 0.3\ A$ $I_B = 30\ mA$ for BUX84 for BUX84A $I_C = 1\ A$ $I_B = 0.2\ A$ for BUX84 for BUX84A			1.5 0.8 3 1	V V V V
$V_{BE(sat)}^*$	Base-emitter Saturation Voltage	$I_C = 1\ A$ $I_B = 0.2\ A$			1.1	V
$V_{CEO(sus)}^*$	Collector-emitter Sustaining Voltage	$I_C = 100\ mA$ $L = 25\ mH$	400			V
f_T	Transition Frequency ($f = 1\ MHz$)	$I_C = 0.2\ A$ $V_{CE} = 10\ V$		20		MHz
t_{on}	Turn-on Time	$I_C = 1\ A$ $V_{CC} = 250\ V$ $I_B = 0.2\ A$ $- I_B = 0.4\ A$			0.5	μs
t_s	Storage Time				3.5	μs
t_f	Fall Time				1.4	μs

* Pulsed : pulse duration = 300 μs , duty cycle $\leq 2\ %$.

HIGH VOLTAGE FAST SWITCHING

ADVANCE DATA

DESCRIPTION

The BUX98 and BUX98A are silicon multi-epitaxial mesa NPN transistors in Jedec TO-3 metal-case intended and industrial applications from single and three-phase mains operation.

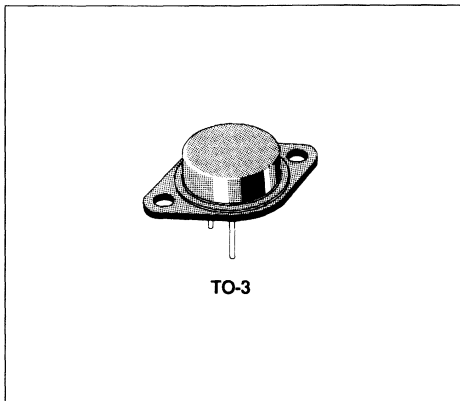

INTERNAL SCHEMATIC DIAGRAMS

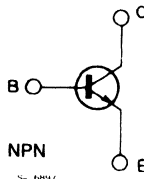

ABSOLUTE MAXIMUM RATINGS

Symbol	Parameter	Value		Unit
		BUX98	BUX98A	
V_{CER}	Collector-emitter Voltage ($R_{BE} \leq 10 \Omega$)	850	1000	V
V_{CES}	Collector-base Voltage ($V_{BE} = 0$)	850	1000	V
V_{CEO}	Collector-emitter Voltage ($I_B = 0$)	400	450	V
V_{EBO}	Emitter-base Voltage ($I_C = 0$)	7		V
I_C	Collector Current	30		A
I_{CM}	Collector Peak Current ($t_p < 5$ ms)	60		A
I_{CP}	Collector Peak Current non Rep. ($t_p < 20 \mu s$)	80		A
I_B	Base Current	8		A
I_{BM}	Base Peak Current ($t_p < 5$ ms)	30		A
P_{Tot}	Total Power Dissipation at $T_{case} < 25 \text{ }^\circ\text{C}$	250		W
T_{stg}	Storage Temperature	- 65 to 200		$^\circ\text{C}$
T_J	Junction Temperature	200		$^\circ\text{C}$

THERMAL DATA

$R_{th\ j-case}$	Thermal Resistance Junction-case	Max	0.7	$^{\circ}C/W$
------------------	----------------------------------	-----	-----	---------------

ELECTRICAL CHARACTERISTICS ($T_{case} = 25\ ^{\circ}C$ unless otherwise specified)

Symbol	Parameter	Test Conditions	Min.	Typ.	Max.	Unit
I_{CER}	Collector Cutoff Current ($R_{BE} = 10\ \Omega$)	$V_{CE} = V_{CES}$ $V_{CE} = V_{CES}$ $T_{case} = 125\ ^{\circ}C$			1 8	μA mA
I_{CES}	Collector Cutoff Current ($V_{BE} = 0$)	$V_{CE} = V_{CES}$ $V_{CE} = V_{CES}$ $T_{case} = 125\ ^{\circ}C$			400 4	μA mA
I_{CEO}	Collector Cutoff Current ($I_B = 0$)	$V_{CE} = V_{CEO}$			2	mA
I_{EBO}	Emitter Cutoff Current ($I_C = 0$)	$V_{EB} = 5\ V$			2	mA
$V_{CEO(sus)}^*$	Collector-emitter Sustaining Voltage	$I_C = 200\ mA$ for BUX98 for BUX98A	400 450			V V
$V_{CER(sus)}^*$	Collector-emitter Sustaining Voltage	$L = 2\ mH$ $I_C = 1\ A$ for BUX98 for BUX98A	850 1000			V V
$V_{CE(sat)}^*$	Collector-emitter Saturation Voltage	for BUX98 $I_C = 20\ A$ $I_B = 4\ A$ for BUX98A $I_C = 16\ A$ $I_B = 3.2\ A$ $I_C = 24\ A$ $I_B = 5\ A$			1.5 1.5 5	V V V
$V_{CE(sat)}^*$	Collector-emitter Saturation Voltage	for BUX98 $I_C = 20\ A$ $I_B = 4\ A$ for BUX98A $I_C = 16\ A$ $I_B = 3.2\ A$			1.6 1.6	V V
t_{on}	Turn-on Time	for BUX98 $V_{CC} = 150\ V$ $I_C = 20\ A, I_{B1} = I_{B2} = 4\ A$			1	μs
t_s	Storage Time				3	μs
t_f	Fall Time				0.8	μs
t_{on}	Turn-on Time	for BUX98A $V_{CC} = 150\ V$ $I_C = 16\ A ; I_{B1} = I_{B2} = 3.2\ A$			1	μs
t_s	Storage Time				3	μs
t_f	Fall Time				0.8	μs

* Pulsed : pulse duration = 300 μs , duty cycle = 1.5 %.

HIGH VOLTAGE SWITCH

DESCRIPTION

The BUX98B and BUX98C are silicon multi-epitaxial mesa NPN transistors in Jedec TO-3 metal case intended for use in switching and industrial applications from single and three-phase mains operations.

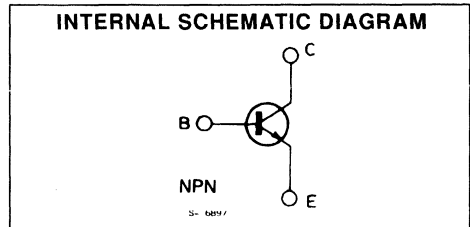
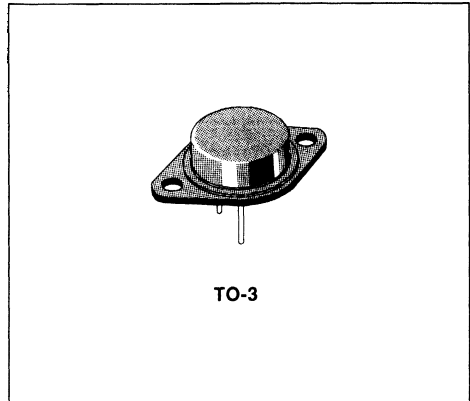

ABSOLUTE MAXIMUM RATINGS

Symbol	Parameter	Value		Unit
		BUX98B	BUX98C	
V _{CER}	Collector-emitter Voltage	1200	1200	V
V _{CES}	Collector-emitter Voltage (V _{BE} = 0)	1200	1200	V
V _{CEX}	Collector-emitter Voltage	600	700	V
V _{EBO}	Emitter-base Voltage (I _C = 0)	7		V
I _C	Collector Current	30		A
I _{CM}	Collector Peak Current	60		A
I _{CP}	Collector Peak Current non Repetitive	80		A
I _B	Base Current	8		A
I _{BM}	Base Peak Current	30		A
P _{tot}	Total Dissipation at T _C < 25 °C	250		W
T _{stg}	Storage Temperature	- 65 to 200		°C
T _J	Max. Operating Junction Temperature	200		°C

THERMAL DATA

$R_{th\ J-case}$	Thermal Resistance Junction-case	Max	0.7	°C/W
------------------	----------------------------------	-----	-----	------

ELECTRICAL CHARACTERISTICS ($T_{case} = 25\text{ °C}$ unless otherwise specified)

Symbol	Parameter	Test Conditions	Min.	Typ.	Max.	Unit
I_{CER}	Collector Cutoff Current ($R_{BE} = 10\ \Omega$)	$V_{CE} = V_{CES}$ $V_{CE} = V_{CES}$ $T_{case} = 125\text{ °C}$			1 8	mA mA
I_{CES}	Collector Cutoff Current ($V_{BE} = 0$)	$V_{CE} = V_{CES}$ $V_{CE} = V_{CES}$ $T_{case} = 125\text{ °C}$			1 6	mA mA
I_{CEO}	Collector Cutoff Current ($I_B = 0$)	$V_{CE} = V_{CEO}$			2	mA
I_{EBO}	Emitter Cutoff Current ($I_C = 0$)	$V_{EB} = 5\text{ V}$			2	mA
$V_{CE(sus)}^*$	Collector-emitter Sustaining Voltage	$I_C = 100\text{ mA}$	700			V
$V_{CE(sat)}^*$	Collector-emitter Saturation Voltage	$I_C = 12\text{ A}$ $I_B = 3\text{ A}$			1.5	V
		$I_C = 16\text{ A}$ $I_B = 5\text{ A}$			2	V
		$I_C = 20\text{ A}$ $I_B = 8\text{ A}$			3	V
$V_{BE(sat)}^*$	Base-emitter Saturation Voltage	$I_C = 12\text{ A}$ $I_B = 3\text{ A}$			1.6	V
		$I_C = 20\text{ A}$ $I_B = 8\text{ A}$			2	V
t_{on}	Turn-on Time	RESISTIVE LOAD		0.5	1	μs
t_s	Storage Time	$V_{CC} = 250\text{ V}$ $I_C = 12\text{ A}$		1.5	3	μs
t_f	Fall Time	$I_{B1} = -I_{B2} = 3\text{ A}$		0.2	0.8	μs

* Pulsed : pulse duration = 300 μs duty cycle = 1.5 %.

Safe Operating Areas.

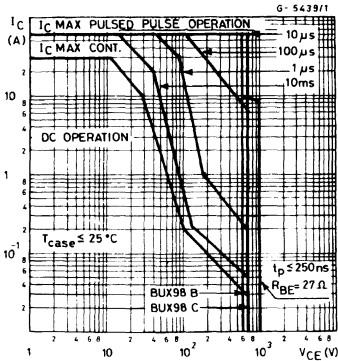

DC Current Gain.

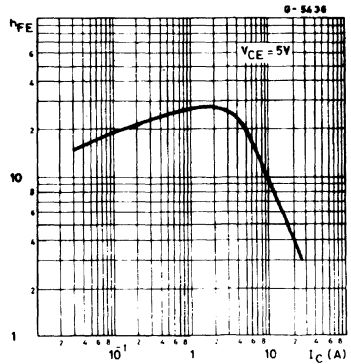

Collector-emitter Saturation Voltage.

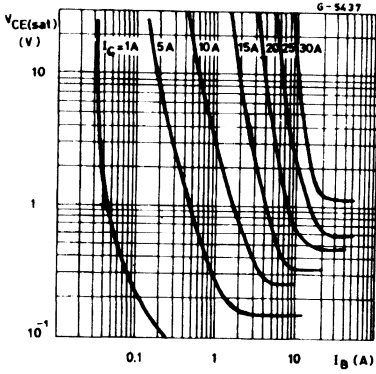

Base-emitter Saturation Voltage.

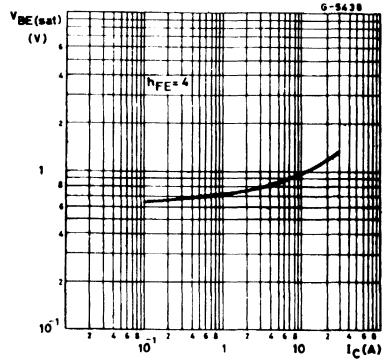

Reverse Biased Operating Area.

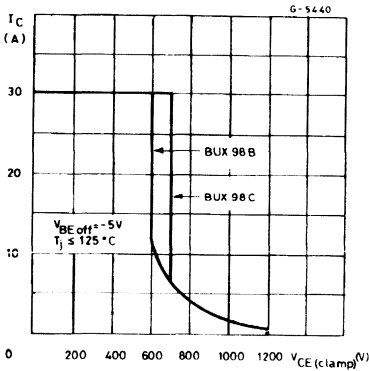



FAST SWITCHING POWER TRANSISTOR

- HIGH VOLTAGE HIGH SPEED TRANSISTOR SUITED FOR USE ON THE 220 AND 380V MAINS
- SUITABLE FOR SWITCH MODE POWER SUPPLY UPS, DC AND AC MOTOR CONTROL

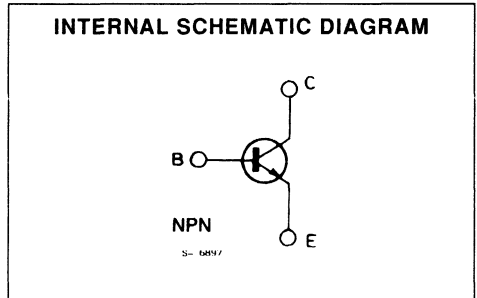
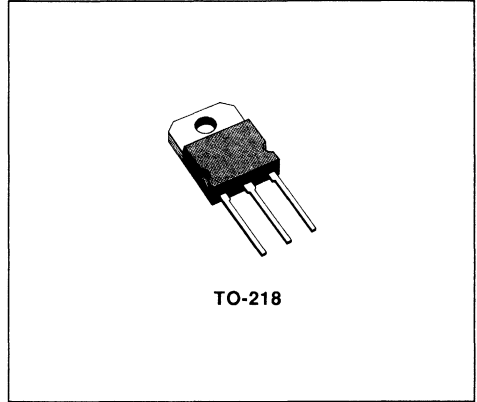

ABSOLUTE MAXIMUM RATINGS

Symbol	Parameter	Value	Unit
V_{CEV}	Collector-emitter Voltage ($V_{BE} = -1.5V$)	850	V
V_{CEO}	Collector-emitter Voltage ($I_B = 0$)	450	V
V_{EBO}	Emitter-base Voltage ($I_C = 0$)	7	V
I_E	Emitter Current	30	A
I_{EM}	Emitter Peak Current	45	A
I_B	Base Current	6	A
I_{BM}	Base Peak Current	10	A
P_{tot}	Total Dissipation at $T_c < 25^\circ C$	200	W
T_{stg}	Storage Temperature	- 65 to 150	$^\circ C$
T_j	Max. Operating Junction Temperature	150	$^\circ C$

THERMAL DATA

$R_{thj-case}$	Thermal Resistance Junction-case	Max	0.63	°C/W
----------------	----------------------------------	-----	------	------

ELECTRICAL CHARACTERISTICS ($T_{case} = 25^{\circ}\text{C}$ unless otherwise specified)

Symbol	Parameter	Test Conditions	Min.	Typ.	Max.	Unit
I_{CER}	Collector Cutoff Current ($R_{BE} = 5\Omega$)	$V_{CE} = V_{CEV}$ $V_{CE} = V_{CEV} T_c = 100^{\circ}\text{C}$			0.2 1	mA mA
I_{CEV}	Collector Cutoff Current	$V_{CE} = V_{CEV} V_{BE} = -1.5\text{V}$ $V_{CE} = V_{CEV} V_{BE} = -1.5\text{V} T_c = 100^{\circ}\text{C}$			0.2 1	mA mA
I_{EBO}	Emitter Cutoff Current ($I_C = 0$)	$V_{EB} = 5\text{V}$			1	mA
$V_{CEO(sus)}^*$	Collector Emitter Sustaining Voltage	$I_C = 0.2\text{A}$ $L = 25\text{mH}$	450			V
V_{EBO}	Emitter-base Voltage ($I_C = 0$)	$I_E = 100\text{mA}$		7		V
$V_{CE(sat)}^*$	Collector-emitter Saturation Voltage	$I_C = 20\text{A} \quad I_B = 4\text{A}$ $I_C = 20\text{A} \quad I_B = 4\text{A} \quad T_j = 100^{\circ}\text{C}$		0.35 0.7	0.9 2	V V
$V_{BE(sat)}^*$	Base-emitter Saturation Voltage	$I_C = 20\text{A} \quad I_B = 4\text{A}$ $I_C = 20\text{A} \quad I_B = 4\text{A} \quad T_j = 100^{\circ}\text{C}$		1.05 1	1.5 1.5	V V
di_C/dt	Rated of Rise of On-state Collector Current	$V_{CC} = 300\text{V} R_C = 0$ $t_p = 3\mu\text{s}$ See fig. 1	120	160		A/ μs
$V_{CE(3\mu\text{s})}$	Collector Emitter Dynamic Voltage	$V_{CC} = 300\text{V}$ $R_C = 15\Omega$ See fig. 1		4.5	8	V .
$V_{CE(5\mu\text{s})}$	Collector Emitter Dynamic Voltage	$V_{CC} = 300\text{V}$ $R_C = 15\Omega$ See fig. 1		2.5	4	V

INDUCTIVE LOAD

Symbol	Parameter	Test Conditions	Min.	Typ.	Max.	Unit
t_s	Storage Time	$V_{CC} = 50\text{V}$ $V_{clamp} = 450\text{V}$		3	4.5	μs
t_f	Fall Time	$I_C = 20\text{A}$ $I_B = 4\text{A}$		0.25	0.4	μs
t_c	Crossover Time	$V_{BB} = -5\text{V}$ $R_{BB} = 0.62\Omega$ $L_C = 0.12\text{mH}$ $T_j = 100^{\circ}\text{C}$ See fig. 2		0.5	0.7	μs
V_{CEW}	Maximum Collector Emitter Voltage without Snubber	$V_{CC} = 50\text{V}$ $V_{BB} = -5\text{V}$ $L_C = 0.08\text{mH}$ $T_j = 125^{\circ}\text{C}$	450			V
		$I_{C\text{Woff}} = 30\text{A}$ $I_{B1} = 4\text{A}$ $R_{BB} = 0.62\Omega$ See fig. 2				

Figure 1 : Switching Times Test Circuit (resistive load).

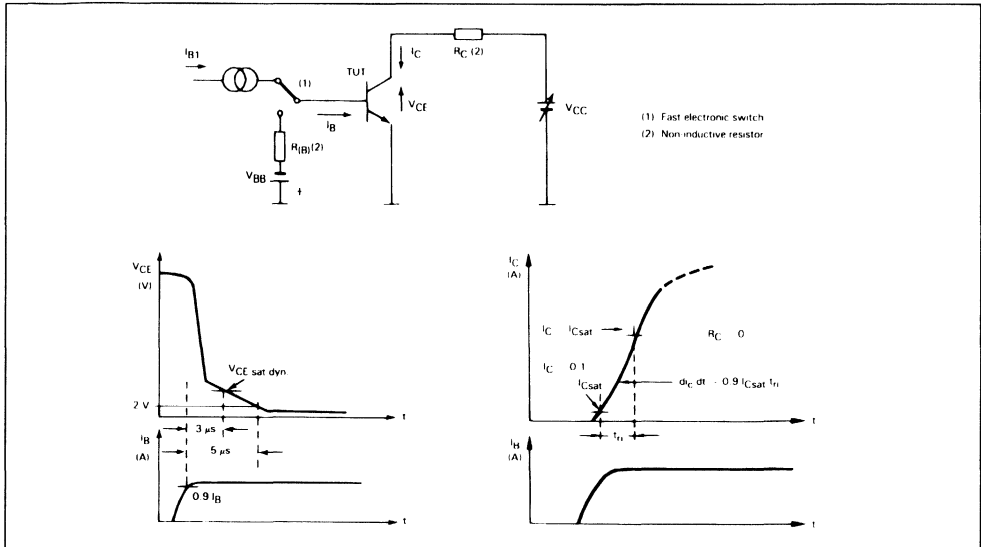

Figure 2a : Turn-off Switching Test Circuit.

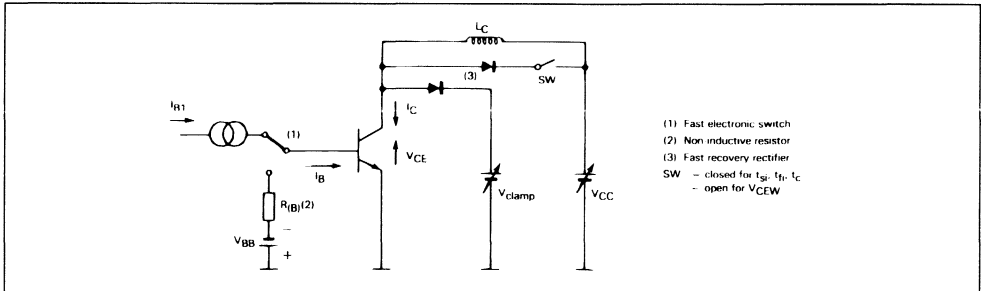
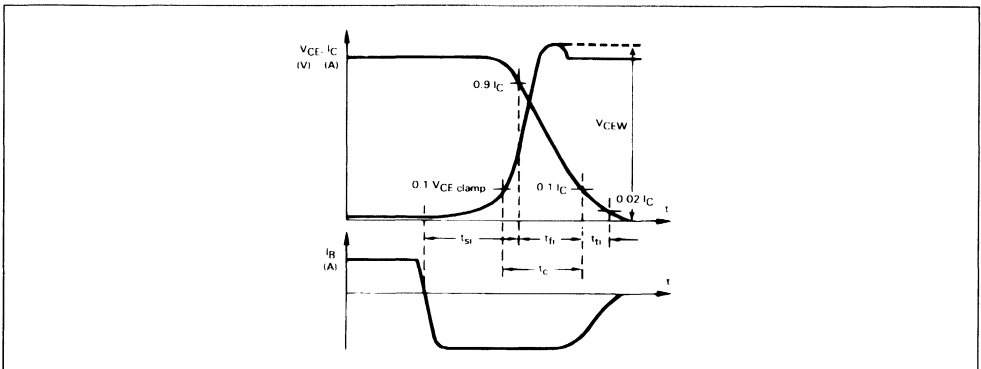
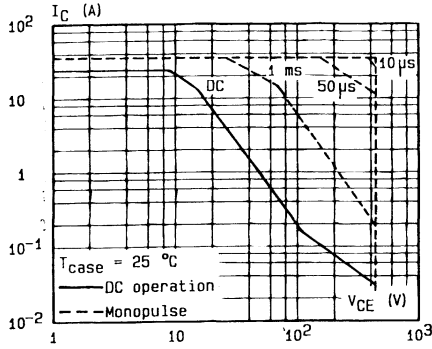

Figure 2b : Turn-off Switching Waveforms (inductive load).



DC and AC Pulse Area.



Power and $I_{S/B}$ Derating versus Case Temperature.

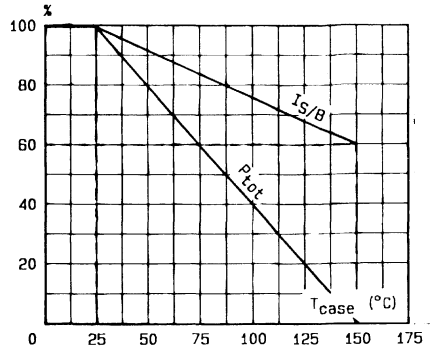

Transient Thermal Response.

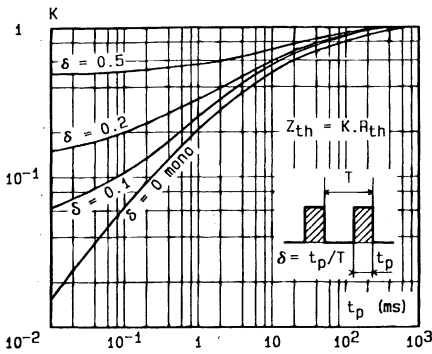

Collector-emitter Voltage versus Base-emitter Resistance.

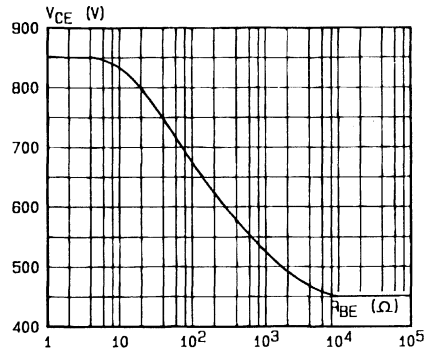

DC Current Gain.

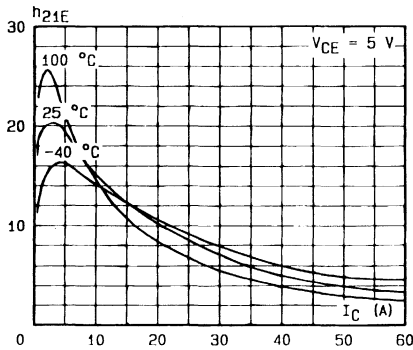

Minimum Base Current to saturate the Transistor.

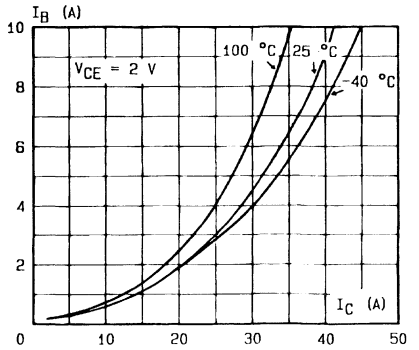

SWITCHING OPERATING AND OVERLOAD AREAS

TRANSISTOR FORWARD BIASED

- During the turn-on
- During the turn-off without negative base-emitter voltage.

TRANSISTOR REVERSE BIASED

- During the turn-off with negative base-emitter voltage.

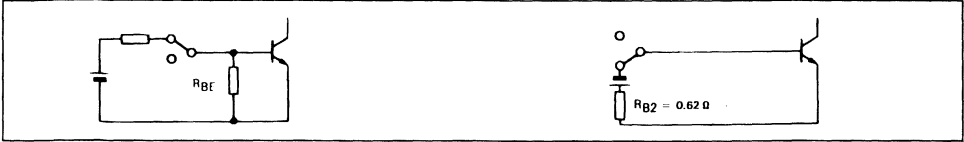

Forward Biased Safe Operating Area (FBSOA).

Reverse Biased Safe Operating Area (RBSOA).

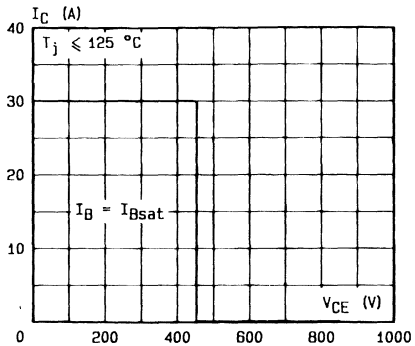
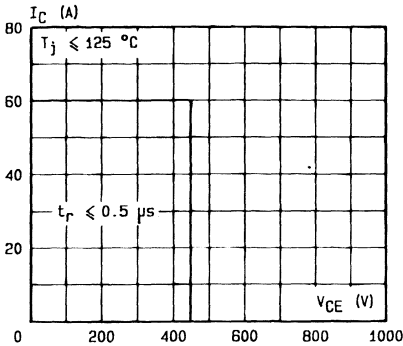

Forward Biased Accidental Overload Area (FBAOA).

Reverse Biased Accidental Overload Area (RBAOA).

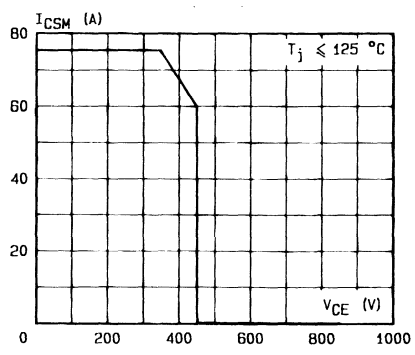
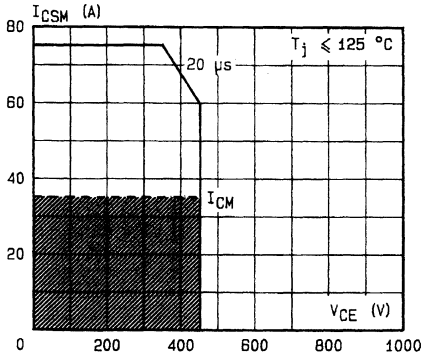

High accidental surge currents ($I > I_{CM}$) are allowed if they are non repetitive and applied less than 3000 times during the component life.

Saturation Voltage.

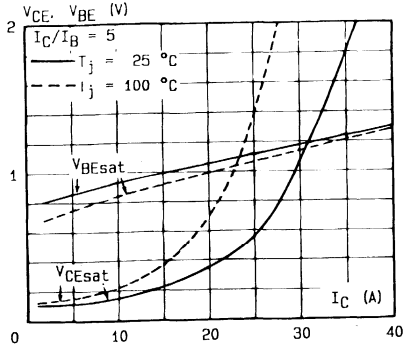

Switching Times versus Collector Current.

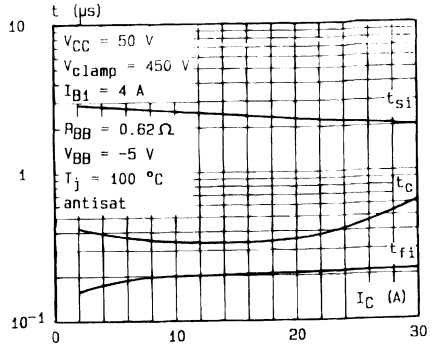

FAST SWITCHING POWER TRANSISTOR

- HIGH VOLTAGE
- FAST SWITCHING
- OFF-LINE APPLICATIONS TO 380V

INDUSTRIAL APPLICATIONS :

- SWITCH MODE POWER SUPPLY
- UNINTERRUPTABLE POWER SUPPLY
- DC AND AC MOTOR CONTROL

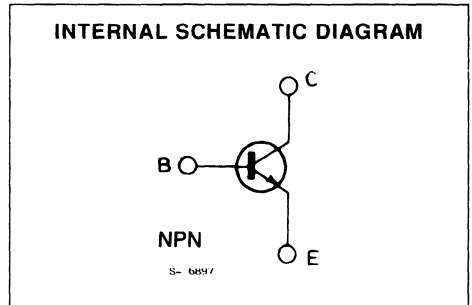
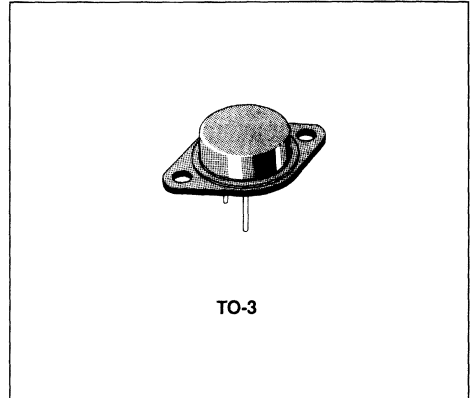
ABSOLUTE MAXIMUM RATINGS

Symbol	Parameter	Value	Unit
V_{CEV}	Collector-emitter Voltage ($V_{BE} = -1.5V$)	850	V
V_{CEO}	Collector-emitter Voltage ($I_B = 0$)	450	V
V_{EBO}	Emitter-base Voltage ($I_C = 0$)	7	V
I_C	Collector Current	45	A
I_{CM}	Collector Peak Current	60	A
I_B	Base Current	9	A
I_{BM}	Base Peak Current	15	A
P_{tot}	Total Dissipation at $T_c < 25^\circ C$	300	W
T_{stg}	Storage Temperature	- 65 to 200	$^\circ C$
T_j	Max. Operating Junction Temperature	200	$^\circ C$

THERMAL DATA

$R_{th(j-case)}$	Thermal Resistance Junction-case	Max	0.58	°C/W
------------------	----------------------------------	-----	------	------

ELECTRICAL CHARACTERISTICS ($T_{case} = 25^{\circ}C$ unless otherwise specified)

Symbol	Parameter	Test Conditions	Min.	Typ.	Max.	Unit
I_{CER}	Collector Cutoff Current ($R_{BE} = 5\Omega$)	$V_{CE} = V_{CEV}$ $V_{CE} = V_{CEV}$ $T_C = 100^{\circ}C$			0.4 2	mA mA
I_{CEV}	Collector Cutoff Current	$V_{CE} = V_{CEV}$ $V_{BE} = -1.5V$ $V_{CE} = V_{CEV}$ $V_{BE} = -1.5V$ $T_C = 100^{\circ}C$			0.4 2	mA mA
I_{EBO}	Emitter Cutoff Current ($I_C = 0$)	$V_{EB} = 5V$			2	mA
$V_{CEO(sus)}$ *	Collector Emitter Sustaining Voltage	$I_C = 0.2A$ $L = 25mH$	450			V
V_{EBO}	Emitter-base Voltage ($I_C = 0$)	$I_E = 100mA$	7			V
$V_{CE(sat)}$ *	Collector-emitter Saturation Voltage	$I_C = 30A$ $I_B = 6A$ $I_C = 30A$ $I_B = 6A$ $T_j = 100^{\circ}C$		0.7 1.35	0.9 2	V V
$V_{BE(sat)}$ *	Base-emitter Saturation Voltage	$I_C = 30A$ $I_B = 6A$ $I_C = 30A$ $I_B = 6A$ $T_j = 100^{\circ}C$		1.12 1.1	1.5 1.5	V V
di_C/dt	Rated of Rise of on-state Collector Current	$V_{CC} = 300V$ $R_C = 0$ $I_{B1} = 9A$ $t_p = 3\mu s$ $T_j = 100^{\circ}C$ See fig.1	150	250		A/ μs
$V_{CE(3\mu s)}$	Collector-emitter Dynamic Voltage Current	$V_{CC} = 300V$ $R_C = 10\Omega$ See fig.1		4.4	8	V
$V_{CE(5\mu s)}$	Collector-emitter Dynamic Voltage Current	$V_{CC} = 300V$ $R_C = 10\Omega$ See fig.1		2.3	4	V

INDUCTIVE LOAD

Symbol	Parameter	Test Conditions	Min.	Typ.	Max.	Unit
t_s	Storage Time	$V_{CC} = 50V$ $V_{clamp} = 450V$		2.75	4.5	μs
t_f	Fall Time	$I_C = 30A$ $I_B = 6A$		0.12	0.4	μs
t_c	Crossover Time	$V_{BB} = -5V$ $R_{BB} = 0.4\Omega$ $L_C = 80\mu H$ $T_j = 100^{\circ}C$ See fig.2		0.44	0.7	μs
V_{CEW}	Maximum Collector Emitter Voltage without Snubber	$V_{CC} = 50V$ $I_{CWoff} = 45A$ $V_{BB} = -5V$ $I_{B1} = 6A$ $L_C = 55\mu H$ $R_{BB} = 0.4\Omega$ $T_j = 125^{\circ}C$ See fig.2	450			V

Figure 1 : Turn-on Switching Characteristics.

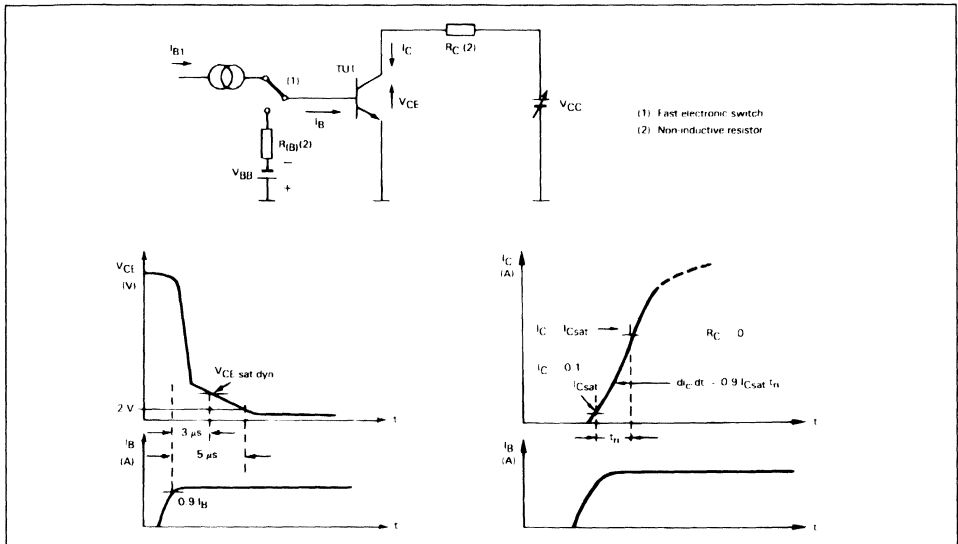

Figure 2a : Turn-off Switching Test Circuit.

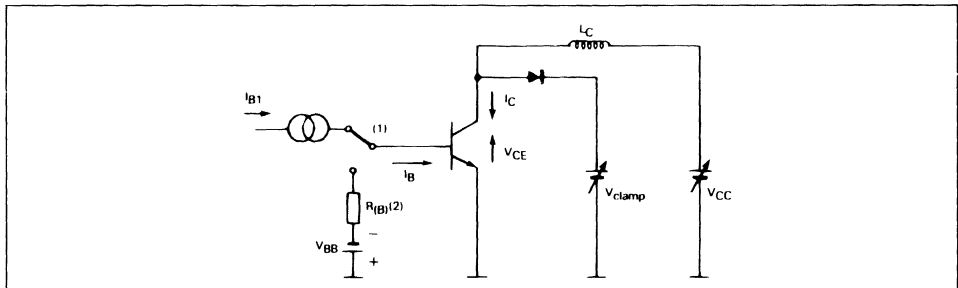
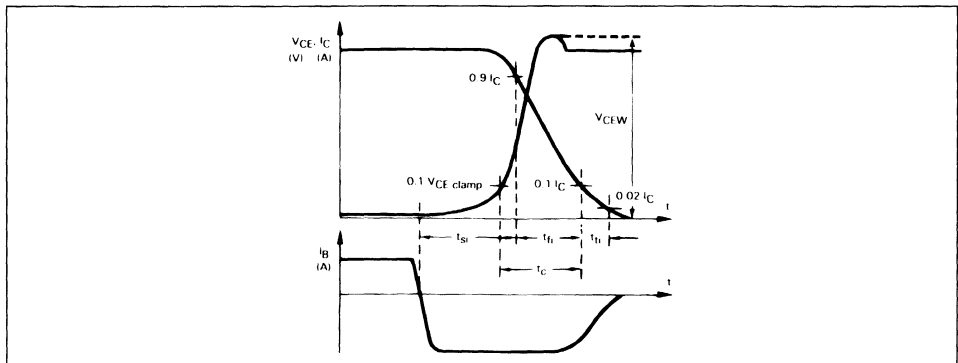
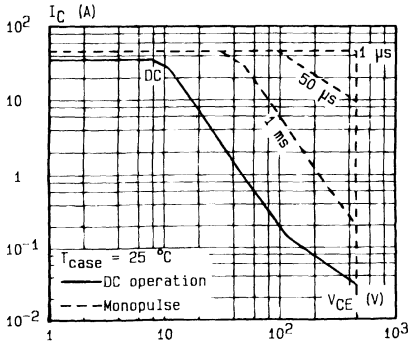

Figure 2b : Turn-off Switching Waveforms (inductive load).



DC and AC Pulse Area.



Power and $I_{S/B}$ Derating versus Case Temperature.

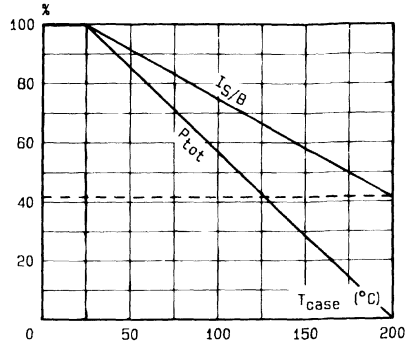

Transient Thermal Response.

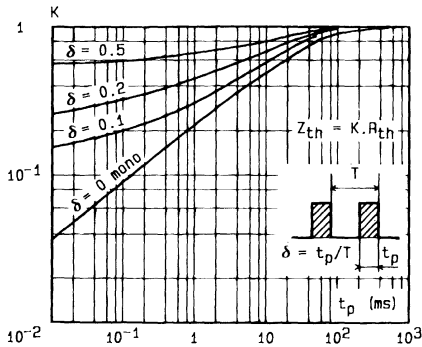

Collector-emitter Voltage versus Base-emitter Resistance.

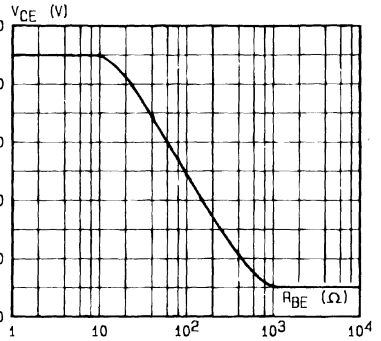

DC Current Gain.

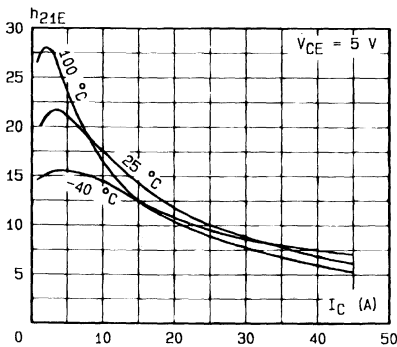

Minimum Base Current to Saturate the Transistor.

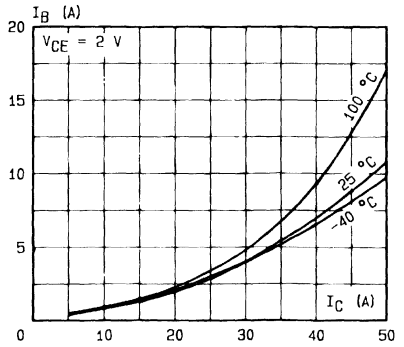

SWITCHING OPERATING AND OVERLOAD AREAS

TRANSISTOR FORWARD BIASED

- During the turn-on
- During the turn-off without negative base-emitter voltage.

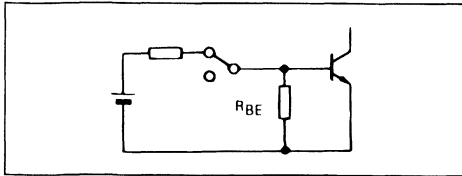

Forward Biased Safe Operating Area (FBSOA).

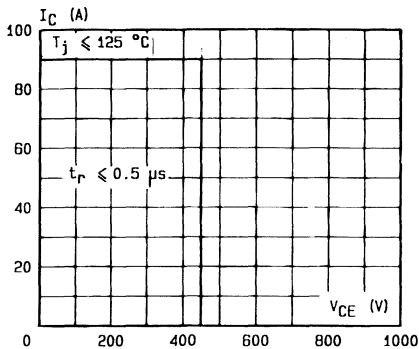

Forward Biased Accidental Overload Area (FBAOA).

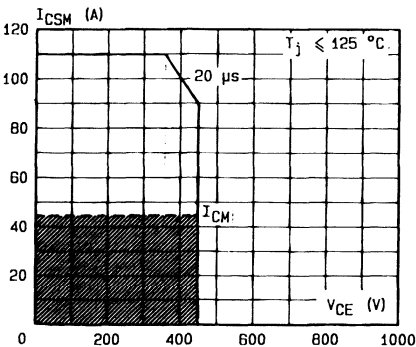

High accidental surge currents ($I > I_{CM}$) are allowed if they are non repetitive and applied less than 3000 times during the component life.

TRANSISTOR REVERSE BIASED

- During the turn-off with negative base-emitter voltage.

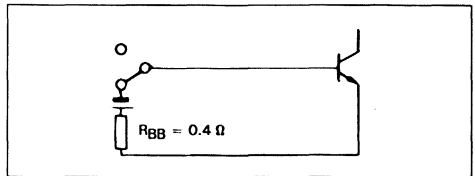

Reverse Biased Safe Operating Area (RBSOA).

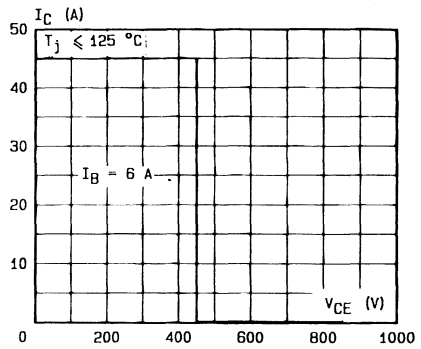

Reverse Biased Accidental Overload Area (RBAOA).

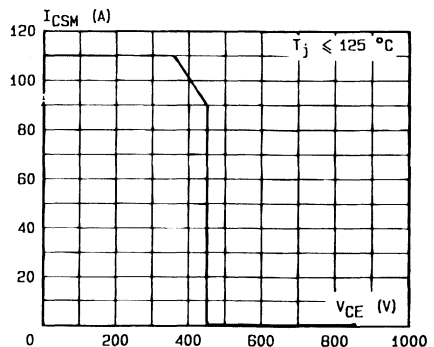

Saturation Voltage.

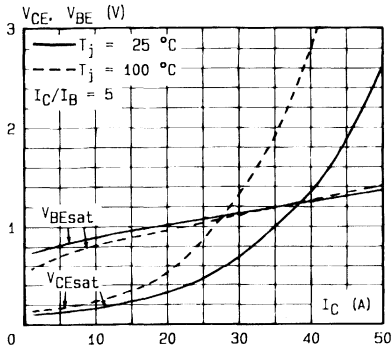

Switching Times versus Collector Current.

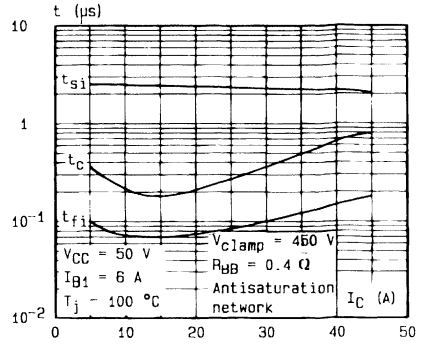

HIGH VOLTAGE, HIGH CURRENT SWITCH

DESCRIPTION

The BUY47 and BUY48 are silicon epitaxial planar NPN transistors in Jedec TO-39 metal case. They are used in high-voltage, high-current switching applications up to 7 A.

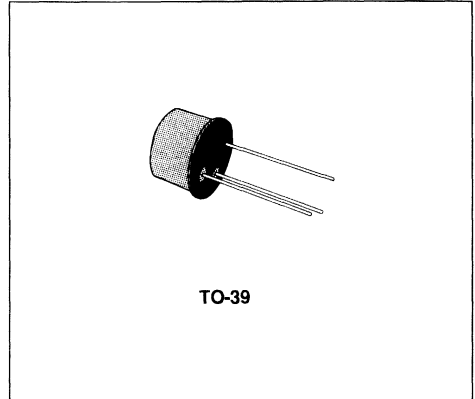

INTERNAL SCHEMATIC DIAGRAM

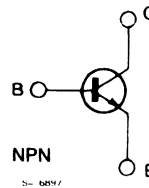

ABSOLUTE MAXIMUM RATINGS

Symbol	Parameter	Value		Unit
		BUY 47	BUY 48	
V_{CBO}	Collector-base Voltage ($I_E = 0$)	150	200	V
V_{CEO}	Collector-emitter Voltage ($I_B = 0$)	120	170	V
V_{EBO}	Emitter-base Voltage ($I_C = 0$)	6		V
I_C	Collector Current	7		A
I_{CM}	Collector Peak Current (repetitive)	10		A
P_{tot}	Total Power Dissipation at $T_{amb} \leq 25^\circ\text{C}$ $T_{case} \leq 50^\circ\text{C}$	1		W
		10		W
T_{stg}	Storage Temperature	- 65 to 200		$^\circ\text{C}$
T_j	Junction Temperature	200		$^\circ\text{C}$

THERMAL DATA

$R_{th\ j-case}$	Thermal Resistance Junction-case	Max	15	°C/W
$R_{th\ j-amb}$	Thermal Resistance Junction-ambient	Max	175	°C/W

ELECTRICAL CHARACTERISTICS ($T_{case} = 25\text{ °C}$ unless otherwise specified)

Symbol	Parameter	Test Conditions	Min.	Typ.	Max.	Unit
I_{CBO}	Collector Cutoff Current ($I_E = 0$)	for BUY 47 $V_{CB} = 80\text{ V}$ $V_{CB} = 80\text{ V}$ for BUY 48 $V_{CB} = 100\text{ V}$ $V_{CB} = 100\text{ V}$			10 1	μA mA
		$T_{case} = 125\text{ °C}$				
		$T_{case} = 125\text{ °C}$			10 1	μA mA
$V_{(BR)CBO}^*$	Collector-base Breakdown Voltage ($I_E = 0$)	$I_C = 1\text{ mA}$	for BUY 47 for BUY 48	150 200		V V
$V_{CEO(sus)}^*$	Collector-emitter Sustaining Voltage ($I_B = 0$)	$I_C = 20\text{ mA}$	for BUY 47 for BUY 48	120 170		V V
V_{EBO}^*	Emitter-base Voltage ($I_C = 0$)	$I_E = 1\text{ mA}$		6		V
$V_{CE(sat)}^*$	Collector-emitter Saturation Voltage	$I_C = 0.5\text{ A}$ $I_C = 2\text{ A}$ $I_C = 5\text{ A}$	$I_B = 50\text{ mA}$ $I_B = 0.2\text{ A}$ $I_B = 0.5\text{ A}$		0.05 0.45 1	V V V
$V_{BE(sat)}^*$	Base-emitter Saturation Voltage	$I_C = 0.5\text{ A}$ $I_C = 2\text{ A}$ $I_C = 5\text{ A}$	$I_B = 50\text{ mA}$ $I_B = 0.2\text{ A}$ $I_B = 0.5\text{ A}$		0.8 1.1 1.5	V V V
h_{FE}^*	DC Current Gain	$I_C = 50\text{ mA}$ $I_C = 0.5\text{ A}$ $I_C = 2\text{ A}$ $I_C = 5\text{ A}$	$V_{CE} = 5\text{ V}$ $V_{CE} = 5\text{ V}$ $V_{CE} = 5\text{ V}$ $V_{CE} = 5\text{ V}$	40 40 15	130 150 130 45	
f_T	Transition Frequency	$I_C = 100\text{ mA}$	$V_{CE} = 10\text{ V}$		90	MHz
C_{CBO}	Collector-base Capacitance	$I_E = 0$ $f = 1\text{ MHz}$	$V_{CB} = 50\text{ V}$		45 80	pF
t_{on}	Turn-on Time	$I_C = 5\text{ A}$	$V_{CC} = 40\text{ V}$		1	μs
t_{off}	Turn-off Time	$I_{B1} = -I_{B2} = 0.5\text{ A}$			2	μs

* Pulsed : pulse duration = 300 μs , duty cycle = 1.5 %.

Safe Operating Areas.

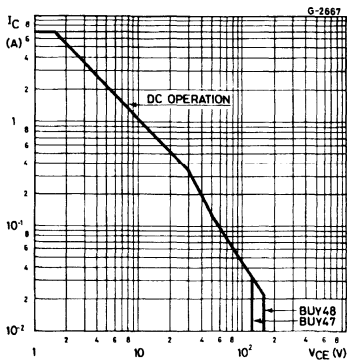

DC Current Gain.

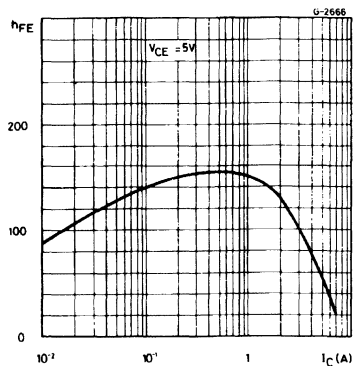

Collector-emitter Saturation Voltage.

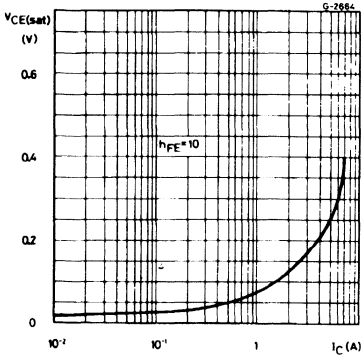

Base-emitter Saturation Voltage.

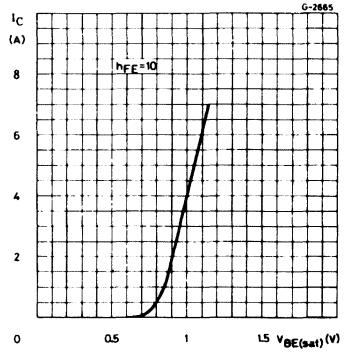

Collector-base Capacitance.

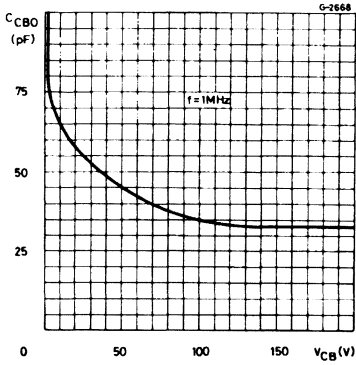

Saturated Switching Characteristics.

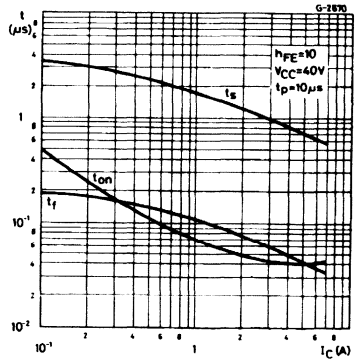

Power Rating Chart.

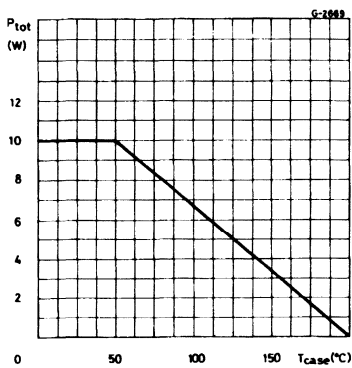

Switching Time Test Circuit.

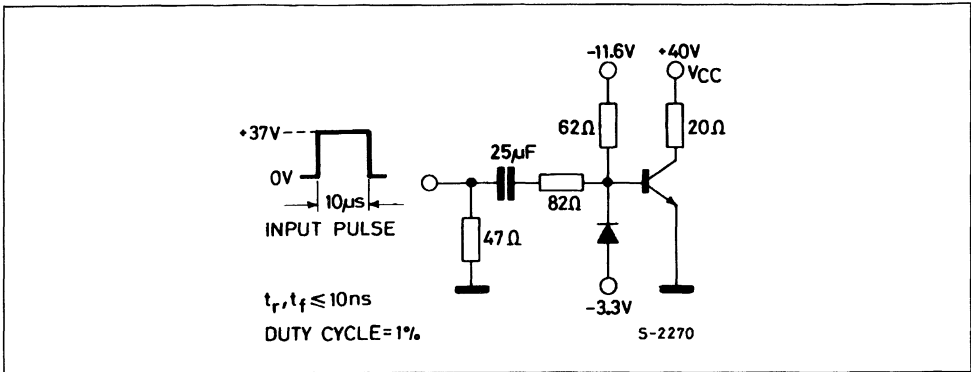

HIGH VOLTAGE, MEDIUM CURRENT SWITCH

DESCRIPTION

The BUY49P is a silicon epitaxial planar NPN transistor in Jedec TO-126 plastic package. It is used in high-current switching applications up to 3A.

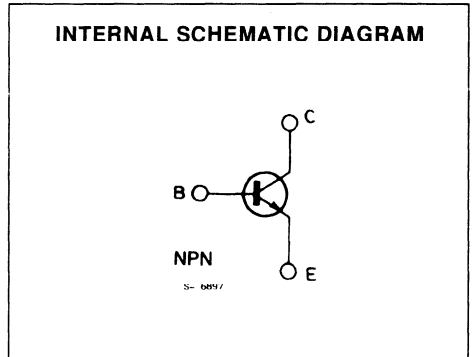
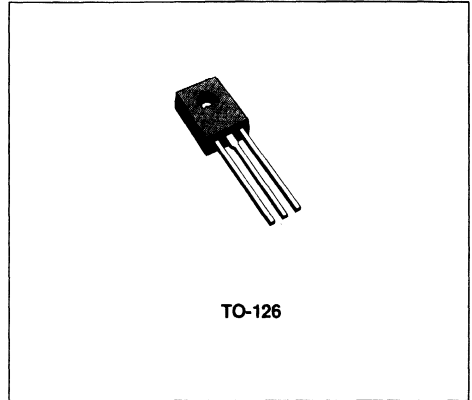

ABSOLUTE MAXIMUM RATINGS

Symbol	Parameter	Value	Unit
V_{CBO}	Collector-base Voltage ($I_E = 0$)	250	V
V_{CEO}	Collector-emitter Voltage ($I_B = 0$)	200	V
V_{EBO}	Emitter-base Voltage ($I_C = 0$)	6	V
I_C	Collector Current	3	A
I_{CM}	Collector Peak Current	5	A
P_{tot}	Total Power Dissipation at $T_{amb} \leq 25^\circ C$	15	W
T_{stg}	Storage Temperature	- 65 to 150	$^\circ C$
T_j	Junction Temperature	150	$^\circ C$

THERMAL DATA

$R_{th(j-case)}$	Thermal Resistance Junction-case	Max	8.33	°C/W
------------------	----------------------------------	-----	------	------

ELECTRICAL CHARACTERISTICS ($T_{case} = 25\text{ °C}$ unless otherwise specified)

Symbol	Parameter	Test Conditions	Min.	Typ.	Max.	Unit
I_{CBO}	Collector Cutoff Current ($I_E = 0$)	$V_{CB} = 200\text{ V}$			0.1	μA
V_{CBO}^*	Collector-base Breakdown Voltage ($I_E = 0$)	$I_C = 100\text{ }\mu\text{A}$	250			V
$V_{CEO(sus)}^*$	Collector-emitter Sustaining Voltage ($I_B = 0$)	$I_C = 20\text{ mA}$	200			V
V_{EBO}^*	Emitter-base Voltage ($I_C = 0$)	$I_E = 1\text{ mA}$	6			V
$V_{CE(sat)}^*$	Collector-emitter Saturation Voltage	$I_C = 0.5\text{ A}$ $I_B = 50\text{ mA}$			0.2	V
$V_{BE(sat)}^*$	Base-emitter Saturation Voltage	$I_C = 0.5\text{ A}$ $I_B = 50\text{ mA}$			1.1	V
h_{FE}^*	DC Current Gain	$I_C = 20\text{ mA}$ $V_{CE} = 2\text{ V}$ $I_C = 20\text{ mA}$ $V_{CE} = 5\text{ V}$ $I_C = 0.5\text{ mA}$ $V_{CE} = 5\text{ V}$ $I_C = 20\text{ mA}$ $V_{CE} = 2\text{ V}$ $T_{case} = -55\text{ °C}$	30 40 40 16		120	
f_T	Transition Frequency	$I_C = 100\text{ mA}$ $V_{CE} = 10\text{ V}$	30			MHz
C_{CBO}	Collector-base Capacitance	$I_E = 0$ $V_{CB} = 10\text{ V}$ $f = 1\text{ MHz}$			50	pF
t_{on}	Turn-on Time	$I_C = 0.5\text{ A}$ $V_{CC} = 20\text{ V}$			0.8	μs
t_{off}	Turn-off Time	$I_{B1} = -I_{B2} = 50\text{ mA}$			2.5	μs

* Pulsed : pulse duration = 300 μs , duty cycle = 1.5 %.

HIGH VOLTAGE, MEDIUM CURRENT SWITCH

DESCRIPTION

The BUY49S is a silicon epitaxial planar NPN transistor in Jedec TO-39 metal case. It is used in high-voltage, high-current switching applications up to 3A.

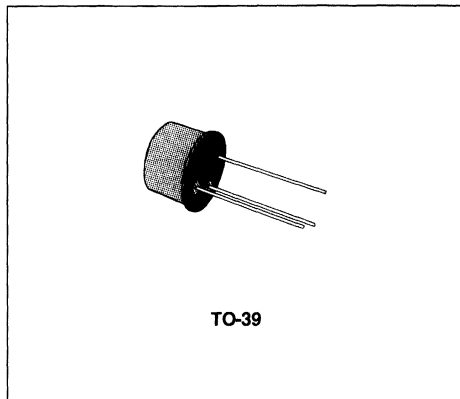

INTERNAL SCHEMATIC DIAGRAM

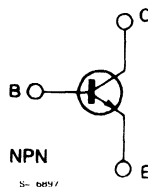

ABSOLUTE MAXIMUM RATINGS

Symbol	Parameter	Value	Unit
V_{CBO}	Collector-base Voltage ($I_E = 0$)	250	V
V_{CEO}	Collector-emitter Voltage ($I_B = 0$)	200	V
V_{EBO}	Emitter-base Voltage ($I_C = 0$)	6	V
I_C	Collector Current	3	A
I_{CM}	Collector Peak Current	5	A
P_{tot}	Total Power Dissipation at $T_{amb} \leq 25^\circ\text{C}$	1	W
	$T_{case} \leq 50^\circ\text{C}$	10	W
T_{stg}	Storage Temperature	- 65 to 200	$^\circ\text{C}$
T_j	Junction Temperature	200	$^\circ\text{C}$

THERMAL DATA

$R_{th\ j-case}$	Thermal Resistance Junction-case	Max	15	°C/W
$R_{th\ j-amb}$	Thermal Resistance Junction-ambient	Max	175	°C/W

ELECTRICAL CHARACTERISTICS ($T_{case} = 25\ ^\circ C$ unless otherwise specified)

Symbol	Parameter	Test Conditions	Min.	Typ.	Max.	Unit
I_{CBO}	Collector Cutoff Current ($I_E = 0$)	$V_{CB} = 200\ V$ $V_{CB} = 200\ V$ $T_{case} = 150\ ^\circ C$			0.1 50	μA μA
$V_{(BR)CBO}^*$	Collector-base Breakdown Voltage ($I_E = 0$)	$I_C = 100\ \mu A$	250			V
$V_{CE(sus)}^*$	Collector-emitter Sustaining Voltage ($I_B = 0$)	$I_C = 20\ mA$	200			V
V_{EBO}^*	Emitter-base Voltage ($I_C = 0$)	$I_E = 1\ mA$	6			V
$V_{CE(sat)}^*$	Collector-emitter Saturation Voltage	$I_C = 0.5\ A$ $I_B = 50\ mA$			0.2	V
$V_{BE(sat)}^*$	Base-emitter Saturation Voltage	$I_C = 0.5\ A$ $I_B = 50\ mA$			1.1	V
h_{FE}^*	DC Current Gain	$I_C = 20\ mA$ $V_{CE} = 5\ V$ $I_C = 0.5\ A$ $V_{CE} = 5\ V$ $I_C = 20\ mA$ $V_{CE} = 2\ V$ $T_{case} = -55\ ^\circ C$	40 40 16	80		
f_T	Transition Frequency	$I_C = 100\ mA$ $V_{CE} = 10\ V$	50			MHz
C_{CBO}	Collector-base Capacitance	$I_E = 0$ $V_{CB} = 10\ V$ $f = 1\ MHz$			30	pF
t_{on}	Turn-on Time	$I_C = 0.5\ A$ $V_{CC} = 20\ V$			0.3	μs
t_{off}	Turn-off Time	$I_{B1} = -I_{B2} = 50\ mA$			1	μs
$I_{s/b}^{**}$	Second Breakdown Collector Current	$V_{CE} = 50\ V$	0.2			A

* Pulsed : pulse duration = 300 μs , duty cycle = 1.5 %.

** Pulsed : 1 s, non repetitive pulse.

Safe Operating Areas.

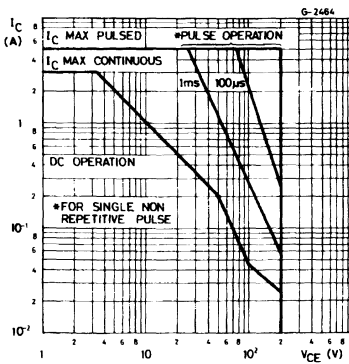

DC Current Gain.

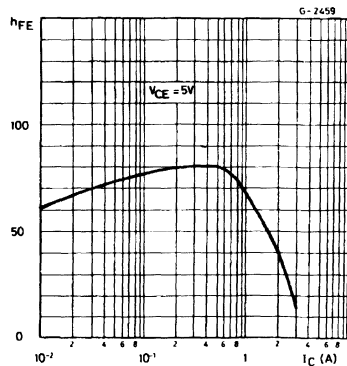

DC Transconductance.

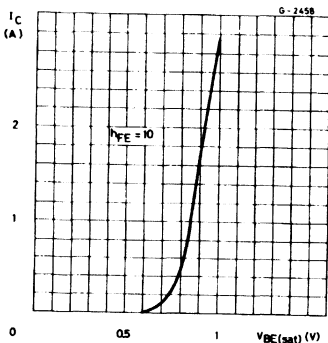

Collector-emitter Saturation Voltage.

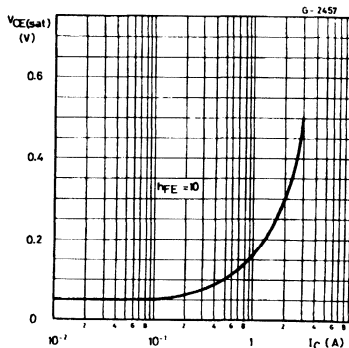

Transition Frequency.

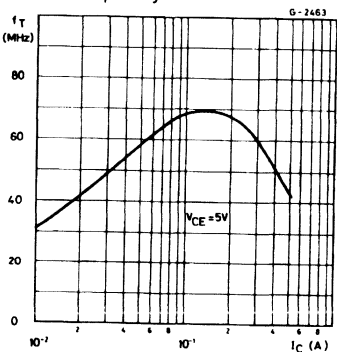

Collector-base Capacitance.

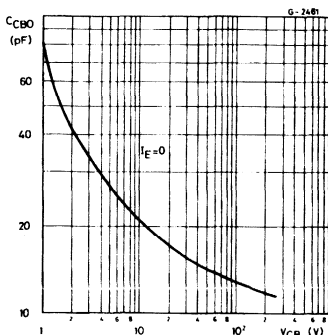

Saturated Switching Characteristics.

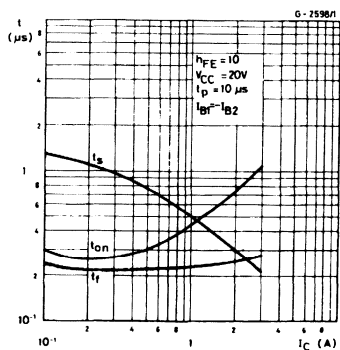

Power Rating Chart.

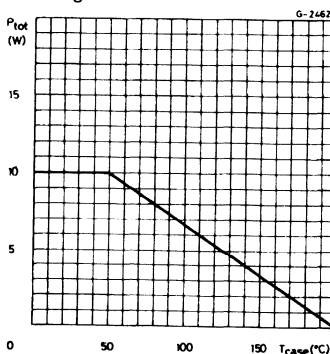

EPITAXIAL PLANAR NPN
DESCRIPTION

The BUY68 is a silicon epitaxial planar NPN transistor in Jedec TO-39 metal case. It is used for high-current switching applications and in power amplifiers. The BUY68 is available in 3 h_{FE} gain bands

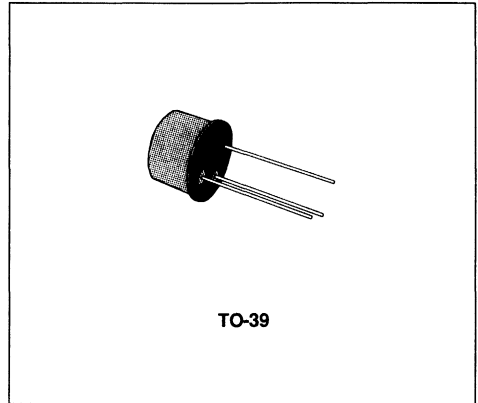
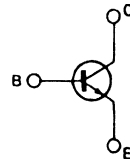
INTERNAL SCHEMATIC DIAGRAM

ABSOLUTE MAXIMUM RATINGS

Symbol	Parameter	Value	Unit
V_{CBO}	Collector-base Voltage ($I_E = 0$)	100	V
V_{CER}	Collector-emitter Voltage ($R_{BE} \leq 10 \Omega$)	80	V
V_{CEO}	Collector-emitter Voltage ($I_B = 0$)	60	V
V_{EBO}	Emitter-base Voltage ($I_C = 0$)	6	V
I_C	Collector Current	7	A
P_{tot}	Total Power Dissipation at $T_{amb} \leq 25^\circ C$ $T_{case} \leq 50^\circ C$	1	W
		10	W
T_{stg}	Storage Temperature	- 65 to 200	$^\circ C$
T_j	Junction Temperature	200	$^\circ C$

THERMAL DATA

$R_{th\ j-case}$	Thermal Resistance Junction-case	Max	15	°C/W
$R_{th\ j-amb}$	Thermal Resistance Junction-ambient	Max	175	°C/W

ELECTRICAL CHARACTERISTICS ($T_{case} = 25\text{ °C}$ unless otherwise specified)

Symbol	Parameter	Test Conditions	Min.	Typ.	Max.	Unit
I_{CBO}	Collector Cutoff Current ($I_E = 0$)	$V_{CB} = 60\text{ V}$			1	μA
$V_{(BR)CBO}^*$	Collector-base Breakdown Voltage ($I_E = 0$)	$I_C = 1\text{ mA}$	100			V
$V_{CER(sus)}^*$	Collector-emitter Sustaining Voltage ($R_{BE} = 10\ \Omega$)	$I_C = 50\text{ mA}$	80			V
$V_{CEO(sus)}^*$	Collector-emitter Sustaining Voltage ($I_B = 0$)	$I_C = 50\text{ mA}$	60			V
V_{EBO}^*	Emitter-base Voltage ($I_C = 0$)	$I_E = 1\text{ mA}$	6			V
$V_{CE(sat)}^*$	Collector-emitter Saturation Voltage	$I_C = 2\text{ A}$ $I_B = 0.2\text{ A}$ $I_C = 5\text{ A}$ $I_B = 0.5\text{ A}$			0.6 1	V V
$V_{BE(sat)}^*$	Base-emitter Saturation Voltage	$I_C = 2\text{ A}$ $I_B = 0.2\text{ A}$ $I_C = 5\text{ A}$ $I_B = 0.5\text{ A}$		1 1.2	1.3 1.6	V V
h_{FE}^*	DC Current Gain	$I_C = 0.1\text{ A}$ $V_{CE} = 1\text{ V}$ Group 6 Group 10 Group 16 $I_C = 1\text{ A}$ $V_{CE} = 1\text{ V}$ Group 6 Group 10 Group 16	40 40 63 100 40 40 63 100	130 70 110 170 130 70 110 170		250 100 160 250
f_T	Transition Frequency	$I_C = 0.5\text{ A}$ $V_{CE} = 5\text{ V}$	50			MHz
C_{CBO}	Collector-base Capacitance	$I_E = 0$ $V_{CB} = 10\text{ V}$ $f = 1\text{ MHz}$			80	pF
t_{on}	Turn-on Time	$I_C = 5\text{ A}$ $V_{CC} = 20\text{ V}$			0.35	μs
t_{off}	Turn-off Time	$I_{B1} = -I_{B2} = 0.5\text{ A}$			0.75	μs

* Pulsed : pulse duration = 300 μs , duty cycle = 1.5 %.

Safe Operating Areas.

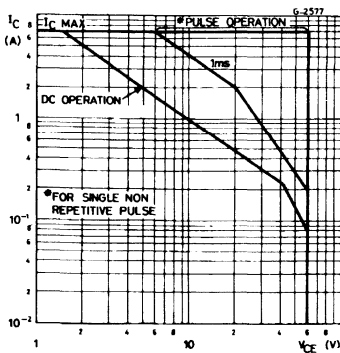

DC Current Gain.

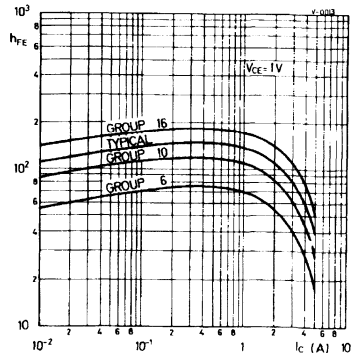

Collector-emitter Saturation Voltage.

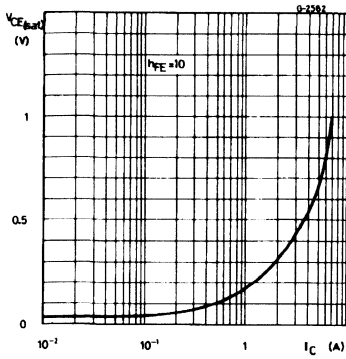

Base-emitter Saturation Voltage.

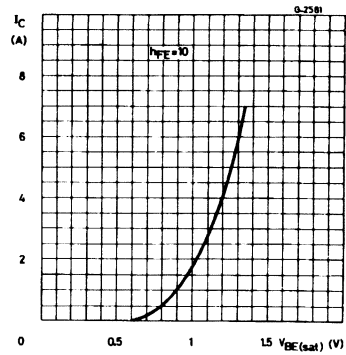

Transition Frequency.

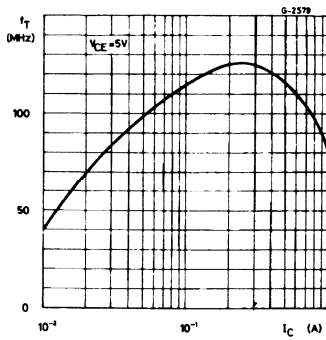

Collector-base Capacitance.

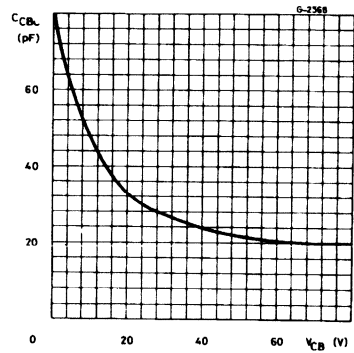

Saturated Switching Characteristics.

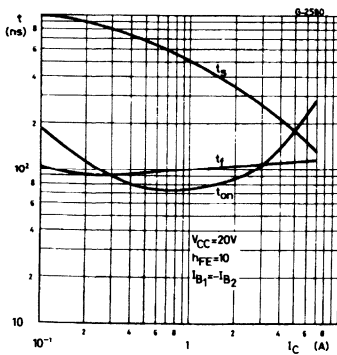

Power Rating Chart.

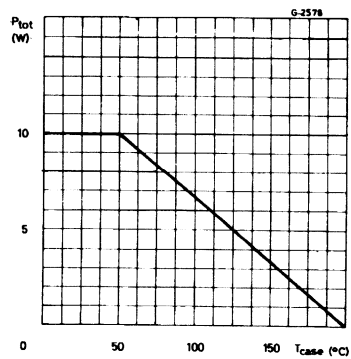

MULTIEPITAXIAL MESA NPN

DESCRIPTION

The BUY69A, BUY69B, and BUY69C are silicon multiepitaxial mesa NPN transistors in Jedec TO-3 metal case. They are intended for horizontal deflection output stage of CTV receivers and high voltage, fast switching and industrial applications.

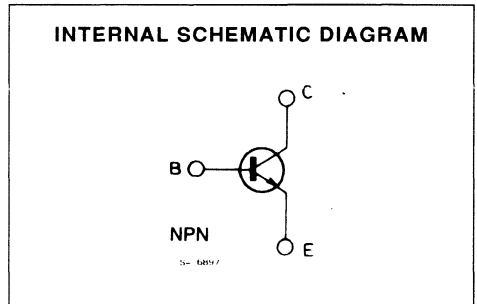
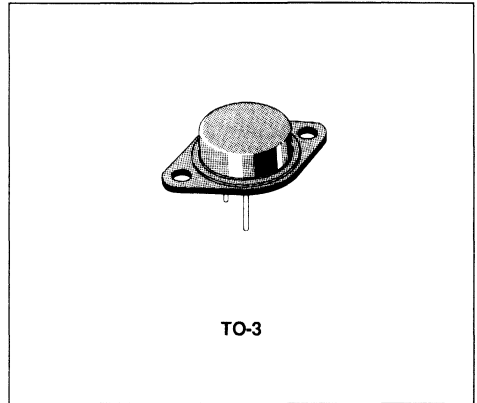

ABSOLUTE MAXIMUM RATINGS

Symbol	Parameter	Value			Unit
		BUY69A	BUY69B	BUY69C	
V_{CES}	Collector-emitter Voltage ($V_{BE} = 0$)	1000	800	500	V
V_{CEO}	Collector-emitter Voltage ($I_B = 0$)	400	325	200	V
V_{EBO}	Emitter-base Voltage ($I_C = 0$)	8			V
I_C	Collector Current	10			A
I_{CM}	Collector Peak Current ($t_p \leq 10$ ms)	15			A
I_B	Base Current	3			A
P_{tot}	Total Power Dissipation at $T_{case} \leq 25$ °C	100			W
T_{stg}	Storage Temperature	- 65 to 200			°C
T_j	Junction Temperature	200			°C

THERMAL DATA

$R_{th\ j-case}$	Thermal Resistance Junction-case	Max	1.75	°C/W
------------------	----------------------------------	-----	------	------

ELECTRICAL CHARACTERISTICS ($T_{case} = 25\text{ °C}$ unless otherwise specified)

Symbol	Parameter	Test Conditions	Min.	Typ.	Max.	Unit
I_{CES}	Collector Cutoff Current ($V_{BE} = 0$)	for BUY69A $V_{CE} = 1000\text{ V}$ for BUY69B $V_{CE} = 800\text{ V}$ for BUY69C $V_{CE} = 500\text{ V}$			1 1 1	mA mA mA
I_{EBO}	Emitter Cutoff Current ($I_C = 0$)	$V_{EB} = 8\text{ V}$			1	mA
V_{CBO}	Collector-base Voltage ($I_E = 0$)	for BUY69A $I_C = 1\text{ mA}$ for BUY69B $I_C = 1\text{ mA}$ for BUY69C $I_C = 1\text{ mA}$	1000 800 500			V V V
$V_{CE0(sus)}^*$	Collector-emitter Sustaining Voltage ($I_B = 0$)	$I_C = 100\text{ mA}$ for BUY69A for BUY69B for BUY69C	400 325 200			V V V
$V_{CE(sat)}^*$	Collector-emitter Saturation Voltage	$I_C = 8\text{ A}$ $I_B = 2.5\text{ A}$			3.3	V
$V_{BE(sat)}^*$	Base-emitter Saturation Voltage	$I_C = 8\text{ A}$ $I_B = 2.5\text{ A}$			2.2	V
h_{FE}^*	DC Current Gain	$I_C = 2.5\text{ A}$ $V_{CE} = 10\text{ V}$	15			
f_T	Transition Frequency	$I_C = 0.5\text{ A}$ $V_{CE} = 10\text{ V}$		10		MHz
$I_{s/b}^{**}$	Second Breakdown Collector Current	$V_{CE} = 25\text{ V}$	4			A
t_{on}	Turn-on Time	$I_C = 5\text{ A}$ $V_{CE} = 250\text{ V}$ $I_{B1} = 1\text{ A}$		0.2		μs
t_s	Storage Time	$I_C = 5\text{ A}$ $V_{CE} = 250\text{ V}$ $I_{B1} = -I_{B2} = 1\text{ A}$		1.7		μs
t_f	Fall Time			0.3		μs
t_f	Fall Time	$I_C = 8\text{ A}$ $V_{CE} = 40\text{ V}$ $I_{B1} = -I_{B2} = 2.5\text{ A}$			1	μs

* Pulsed : pulse duration = 300 μs , duty cycle = 1.5 %.

** Pulsed : 1 s, non repetitive pulse.

For characteristics curves see the BUW 34/5/6 series.

LINEAR AND SWITCHING APPLICATIONS

DESCRIPTION

The D44C1 to D44C12 are silicon multiepitaxial planar transistors in TO-220 plastic package intended for linear and switching applications.

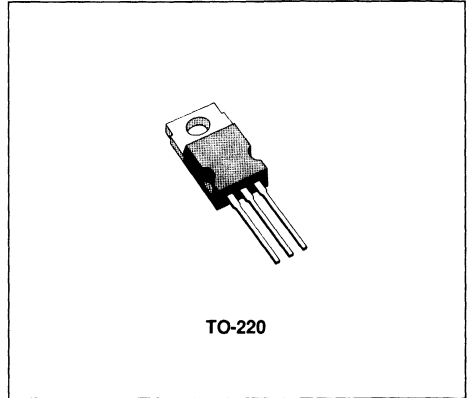

INTERNAL SCHEMATIC DIAGRAM

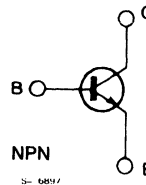

ABSOLUTE MAXIMUM RATINGS

Symbol	Parameter	Value				Unit
		D44C 1/2/3	D44C 4/5/6	D44C 7/8/9	D44C 10/11/12	
V_{CES}	Collector-emitter Voltage ($V_{BE} = 0$)	40	55	70	90	V
V_{CEO}	Collector -emitter Voltage ($I_B = 0$)	30	45	60	80	V
V_{EBO}	Emitter-base Voltage ($I_C = 0$)	5	5	5	5	V
I_C	Collector Current	4				A
I_{CM}	Collector Peak Current ($t_p = 10$ ms)	6				A
P_{Tot}	Total Power Dissipation $T_{case} \leq 25$ °C $T_{amb} \leq 25$ °C	30				W
		1.67				W
T_{stg}	Storage Temperature	- 55 to 150				°C
T_j	Junction Temperature	150				°C

THERMAL DATA

$R_{th\ j-case}$	Thermal Resistance Junction-case	Max	4.2	°C/W
$R_{th\ j-amb}$	Thermal Resistance Junction-ambient	Max	75	°C/W

ELECTRICAL CHARACTERISTICS ($T_{case} = 25\text{ °C}$ unless otherwise specified)

Symbol	Parameter	Test Conditions	Min.	Typ.	Max.	Unit
I_{CES}	Collector Cutoff Current ($V_{BE} = 0$)	$V_{CE} = \text{Rated } V_{CES}$			10	μA
I_{EBO}^*	Emitter Cutoff Current ($I_C = 0$)	$V_{EB} = 5\text{ V}$			100	μA
$V_{CE(sus)}^*$	Collector-emitter Sustaining Voltage	$I_C = 100\text{ mA}$ for D44C1-2-3 for D44C4-5-6 for D44C7-8-9 for D44C10-11-12	30 45 60 80			V V V V
$V_{CE(sat)}^*$	Collector-emitter Saturation Voltage	$I_C = 1\text{ A}$ $I_B = 50\text{ mA}$ for D44C2-3-5-6-8-9-11-12 $I_C = 1\text{ A}$ $I_B = 0.1\text{ A}$ for D44C1-4-7-10			0.5 0.5	V V
$V_{BE(sat)}^*$	Base-emitter Saturation Voltage	$I_C = 1\text{ A}$ $I_B = 100\text{ mA}$			1.3	V
h_{FE}^*	DC Current Gain	$I_C = 0.2\text{ A}$ $V_{CE} = 1\text{ V}$ $I_C = 2\text{ A}$ $V_{CE} = 1\text{ V}$ for D44C3-6-9-12 $I_C = 0.2\text{ A}$ $V_{CE} = 1\text{ V}$ $I_C = 1\text{ A}$ $V_{CE} = 1\text{ V}$ for D44C2-5-8-11 $I_C = 0.2\text{ A}$ $V_{CE} = 1\text{ V}$ $I_C = 1\text{ A}$ $V_{CE} = 1\text{ V}$ for D44C1-4-7-10	40 20 100 20 25 10		120 220	

* Pulsed : pulse duration = 300 μs , duty cycle = 2%.

SWITCHING APPLICATIONS GENERAL PURPOSE

DESCRIPTION

The D44H series are silicon multiepitaxial planar transistors and are mounted in Jedec TO-220 plastic package.

They are intended for various switching and general purpose applications.

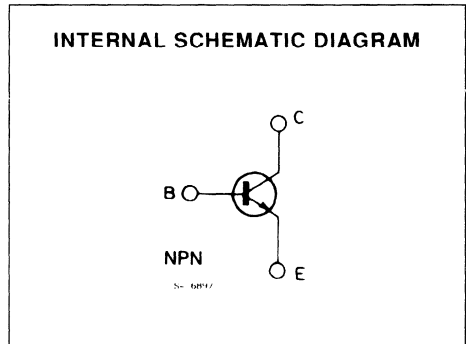
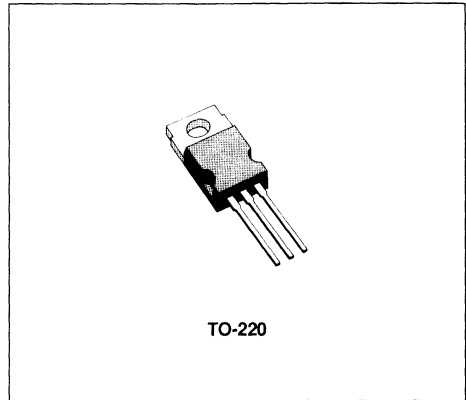

ABSOLUTE MAXIMUM RATINGS

Symbol	Parameter	Value				Unit
		D44H 1/2	D44H 4/5	D44H 7/8	D44H 10/11	
V_{CE0}	Collector-emitter Voltage ($I_B = 0$)	30	45	60	80	V
V_{EB0}	Emitter-base Voltage ($I_C = 0$)	5				V
I_C	Collector Current	10				A
I_{CM}	Collector Peak Current	20				A
P_{tot}	Total Power Dissipation $T_{case} \leq 25^\circ C$	50				W
T_{stg}	Storage Temperature	- 55 to 150				$^\circ C$
T_j	Junction Temperature	150				$^\circ C$

THERMAL DATA

$R_{th\ j-case}$	Thermal Resistance Junction-case	Max	2.5	°C/W
------------------	----------------------------------	-----	-----	------

ELECTRICAL CHARACTERISTICS ($T_{case} = 25\text{ °C}$ unless otherwise specified)

Symbol	Parameter	Test Conditions	Min.	Typ.	Max.	Unit
I_{CBO}	Collector Cutoff Current ($I_E = 0$)	$V_{CB} = \text{Rated } V_{CEO}$			10	μA
I_{EBO}	Emitter Cutoff Current ($I_C = 0$)	$V_{EB} = \text{Rated } V_{EBO}$			100	μA
$V_{CEO(sus)}^*$	Collector-emitter Sustaining Voltage	$I_C = 100\text{ mA}$ for D44H1/2 for D44H4/5 for D44H7/8 for D44H10/11	30 45 60 80			V V V V
$V_{CE(sat)}^*$	Collector-emitter Saturation Voltage	$I_C = 8\text{ A}$ $I_B = 0.4\text{ A}$ for D44H2/5/8/11 $I_C = 8\text{ A}$ $I_B = 0.8\text{ A}$ for D44H1/4/7/10			1 1	V V
$V_{BE(sat)}^*$	Base-emitter Saturation Voltage	$I_C = 8\text{ A}$ $I_B = 0.8\text{ A}$			1.5	V
h_{FE}^*	DC Current Gain	$V_{CE} = 1\text{ V}$ $I_C = 2\text{ A}$ for D44H1/4/7/10 for D44H2/5/8/11 $V_{CE} = 1\text{ V}$ $I_C = 4\text{ A}$ for D44H1/4/7/10 for D44H2/5/8/11	35 60 20 40			

* Pulsed : pulse duration = 300 μs , duty cycle = 1,5%.



MULTIEPITAXIAL PLANAR NPN

DESCRIPTION

The D44Q1, D44Q3, D44Q5 are silicon multiepitaxial planar transistors in TO-220 plastic package intended for linear and switching applications.

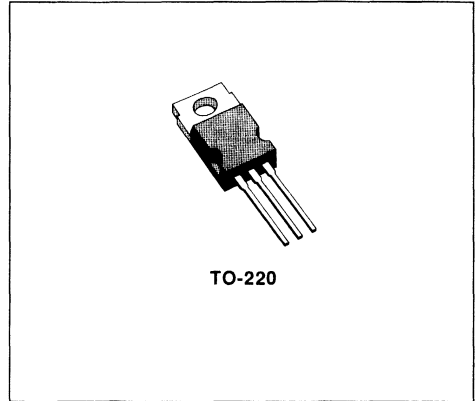

INTERNAL SCHEMATIC DIAGRAM

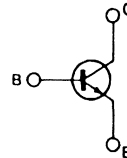

ABSOLUTE MAXIMUM RATINGS

Symbol	Parameter	Value			Unit
		D44Q1	D44Q3	D44Q5	
V_{CBO}	Collector-base Voltage ($I_E = 0$)	200	250	300	V
V_{CEO}	Collector-emitter Voltage ($I_B = 0$)	125	175	225	V
V_{EBO}	Emitter-base Voltage ($I_B = 0$)	7	7	7	V
I_C	Collector Current	4			A
P_{tot}	Total Power Dissipation $T_{case} \leq 25\text{ }^\circ\text{C}$ $T_{amb} \leq 25\text{ }^\circ\text{C}$	31.25			W
		1.67			W
T_{stg}	Storage Temperature	- 55 to 150			$^\circ\text{C}$
T_j	Junction Temperature	150			$^\circ\text{C}$

THERMAL DATA

$R_{th\ j-case}$	Thermal Resistance Junction-case	Max	4	$^{\circ}C/W$
$R_{th\ j-amb}$	Thermal Resistance Junction-ambient	Max	75	$^{\circ}C/W$

ELECTRICAL CHARACTERISTICS ($T_{case} = 25\ ^{\circ}C$ unless otherwise specified)

Symbol	Parameter	Test Conditions	Min.	Typ.	Max.	Unit
I_{CBO}	Collector Cutoff Current ($I_E = 0$)	Rated V_{CE0}			10	μA
$V_{CE0(sus)}^*$	Collector Emitter Sustaining Voltage	$I_C = 10\ mA$ for D44Q1 for D44Q3 for D44Q5	125 175 225			V V V
$V_{CE(sat)}^*$	Collector-emitter Saturation Voltage	$I_C = 2\ A$ $I_B = 0.2\ A$			1	V
$V_{BE(sat)}^*$	Base-emitter Saturation Voltage	$I_C = 2\ A$ $I_B = 0.2\ A$			1.3	V
h_{FE}^*	DC Current Gain	$I_C = 0.2\ A$ $V_{CE} = 10\ V$ $I_C = 2\ A$ $V_{CE} = 10\ V$	30 20			
f_T	Transition Frequency	$I_C = 100\ mA$ $V_{CE} = 10\ V$		20		MHz
C_{CBO}	Collector Base Capacitance	$V_{CB} = 10\ V$ $f = 1\ MHz$		32		pF
t_{on}	Turn-in Time	$V_{CC} = 50\ V$ $I_C = 1\ A$ $I_{B1} = -I_{B2} = 0.1\ A$			0.4	μs
t_s	Storage Time				2	μs
t_f	Fall Time				1.7	μs

* Pulsed : pulse duration = 300 μs , duty cycle = 2 %.

PNP LOW VOLTAGE TRANSISTOR

PRELIMINARY DATA

- LOW COLLECTOR SATURATION VOLTAGE
- EXCELLENT LINEARITY

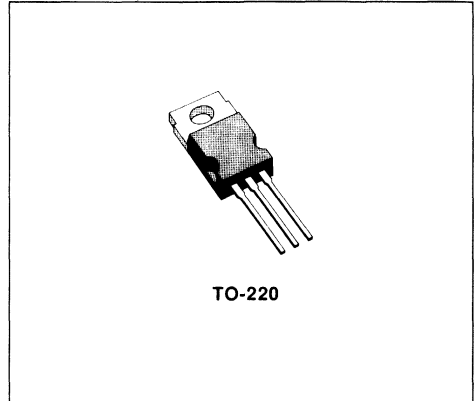

DESCRIPTION

The D45H1, D45H2, D45H4, D45H5, D45H7, D45H8 and D45H10 are silicon multiepitaxial planar PNP transistors in TO-220 plastic package, intended for switching and general purpose applications.

The complementary NPN types are the D44H1, D44H2, D44H4, D44H5, D44H7, D44H8 and D44H10 respectively.

INTERNAL SCHEMATIC DIAGRAM

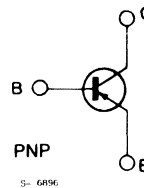

ABSOLUTE MAXIMUM RATINGS

Symbol	Parameter	Value				Unit
		D45H1 D45H2	D45H4 D45H5	D45H7 D45H8	D45H10	
V_{CBO}	Collector-base Voltage ($I_E = 0$)	- 30	- 45	- 60	- 80	V
V_{CEO}	Collector-emitter Voltage ($I_B = 0$)	- 30	- 45	- 60	- 80	V
V_{EBO}	Emitter-base Voltage ($I_C = 0$)	- 5				V
I_C	Collector Current	- 10				A
I_{CM}	Collector Peak Current	- 20				A
I_B	Base Current	- 5				mA
P_{Tot}	Total Dissipation at $T_c < 25^\circ\text{C}$	50				W
T_{stg}	Storage Temperature	- 55 to 150				$^\circ\text{C}$
T_j	Max. Operating Junction Temperature	150				$^\circ\text{C}$

THERMAL DATA

$R_{thj-case}$	Thermal Resistance Junction-case	max	2.5	°C/W
----------------	----------------------------------	-----	-----	------

ELECTRICAL CHARACTERISTICS ($T_{case} = 25^{\circ}C$ unless otherwise specified)

Symbol	Parameter	Test Conditions	Min.	Typ.	Max.	Unit
I_{CBO}	Collector Cutoff Current ($I_E = 0$)	$V_{CB} = -30V$ for D45H1/2 $V_{CB} = -45V$ for D45H4/5 $V_{CB} = -60V$ for D45H7/8 $V_{CB} = -80V$ for D45H10			- 10 - 10 - 10 - 10	μA μA μA μA
I_{EBO}	Emitter Cutoff Current ($I_C = 0$)	$V_{EB} = -5V$			- 0.1	mA
$V_{CE(sus)}^*$	Collector-emitter Sustaining Voltage	$I_C = -0.1A$ for D45H1/2 for D45H4/5 for D45H7/8 for D45H10	- 30 - 45 - 60 - 80			V V V V
$V_{CE(sat)}^*$	Collector-emitter Saturation Voltage	$I_C = -8A$ $I_B = -0.4A$ for D45H2/5/8 $I_C = -8A$ $I_B = -0.8A$ for D45H1/4/7/10			- 1 - 1	V V
$V_{BE(sat)}^*$	Base-emitter Saturation Voltage	$I_C = -8A$ $I_B = -0.8A$			- 1.5	V
h_{FE}^*	DC Current Gain	$I_C = -2A$ $V_{CE} = -1V$ for D45H2/5/8 for D45H1/4/7/10 $I_C = -4A$ $V_{CE} = -1V$ for D45H2/5/8 for D45H1/4/7/10	60 35 40 20	120 60 70 50		

* Pulsed : Pulse duration = 300 μs , duty cycle = 1.5%.

COMPLEMENTARY HIGH POWER TRANSISTORS

DESCRIPTION

The MJ802 (NPN) and MJ4502 (PNP) are silicon epitaxial-base complementary power transistors in Jedec TO-3 metal case, intended for general purpose power amplifier and switching applications.

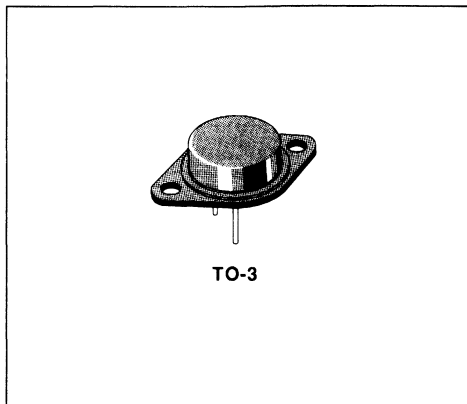

INTERNAL SCHEMATIC DIAGRAMS

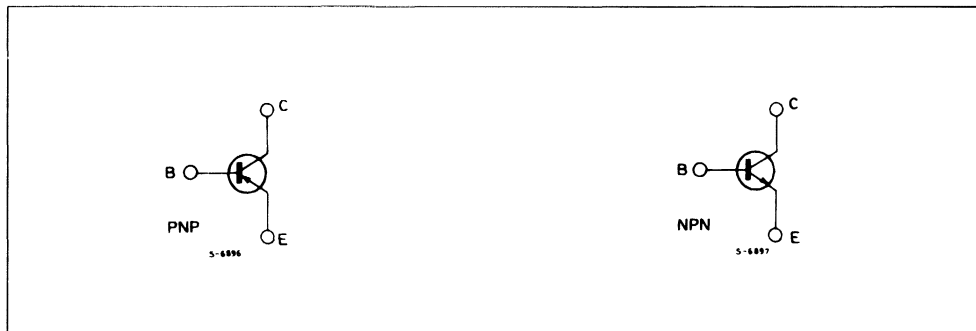

ABSOLUTE MAXIMUM RATINGS

Symbol	Parameter	Value	Unit
V_{CEO}	Collector-emitter Voltage ($I_B = 0$)	90	V
V_{CBO}	Collector-base Voltage ($I_E = 0$)	100	V
V_{EBO}	Emitter-base Voltage ($I_C = 0$)	4	V
I_C	Collector Current	30	A
I_B	Base Current	7.5	A
P_{tot}	Total Power Dissipation at $T_{case} \leq 25^\circ\text{C}$	200	W
T_{stg}	Storage Temperature	- 65 to 200	$^\circ\text{C}$
T_j	Junction Temperature	200	$^\circ\text{C}$

THERMAL DATA

$R_{th(j-case)}$	Thermal Resistance Junction-case	Max	0.875	$^{\circ}C/W$
------------------	----------------------------------	-----	-------	---------------

ELECTRICAL CHARACTERISTICS ($T_{case} = 25^{\circ}C$ unless otherwise specified)

Symbol	Parameter	Test Conditions	Min.	Typ.	Max.	Unit
$V_{CE0(8us)}$ *	Collector-emitter Sustaining Voltage ($I_B = 0$)	$I_C = 200\text{ mA}$	90			V
I_{CBO}	Collector Cutoff Current ($I_E = 0$)	$V_{CB} = 100V$ $T_{case} = 150^{\circ}C$			1 5	mA mA
I_{EBO}	Emitter Cutoff Current ($I_C = 0$)	$V_{EB} = 4V$			1	mA
$V_{CE0(8us)}$ *	Collector-emitter Sustaining Voltage ($R_{BE} = 100\Omega$)	$I_C = 200mA$	100			V
h_{FE} *	DC Current Gain	$I_C = 7.5A$ $V_{CE} = 2V$	25		100	
$V_{CE(sat)}$ *	Collector-emitter Saturation Voltage	$I_C = 7.5A$ $I_B = 0.75A$			0.8	V
$V_{BE(sat)}$ *	Base-emitter Saturation Voltage	$I_C = 7.5A$ $I_B = 0.75A$			1.3	V
V_{BE} *	Base-emitter Voltage	$I_C = 7.5A$ $V_{CE} = 2V$			1.3	V
f_T	Transition Frequency	$I_C = 1A$ $V_{CE} = 10V$ $f = 1MHz$	2			MHz

* Pulsed : pulse duration = 300 μs , duty cycle $\leq 2\%$.
For PNP type voltage and current values are negative.

Safe Operating Areas.

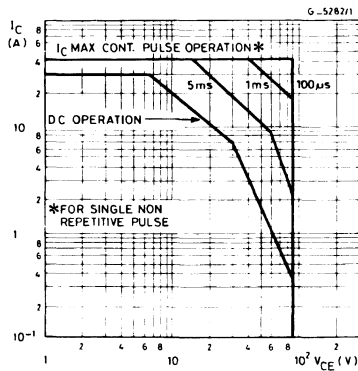

DC Current Gain (NPN type).

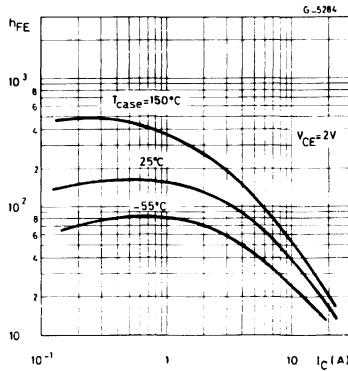

DC Current Gain (PNP type).

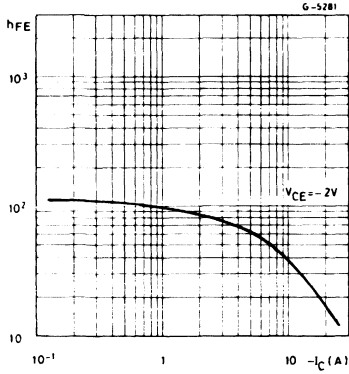

Base-emitter Voltage (PNP type).

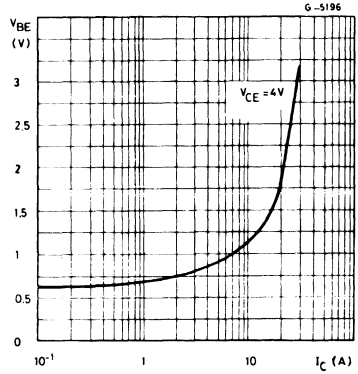

Saturation Voltage (NPN type).

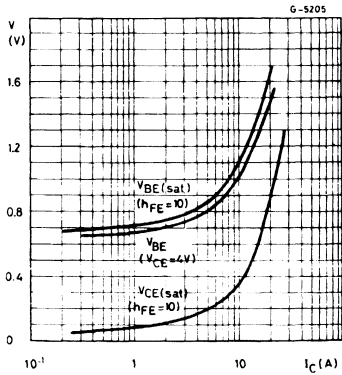

Base-emitter Saturation Voltage (PNP type).

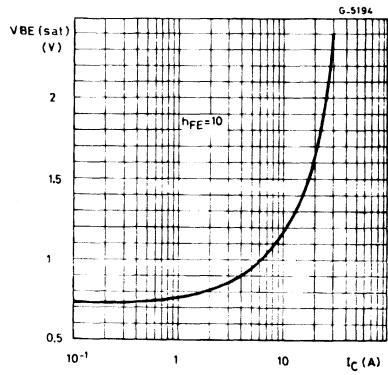

Collector-emitter Saturation Voltage (NPN type).

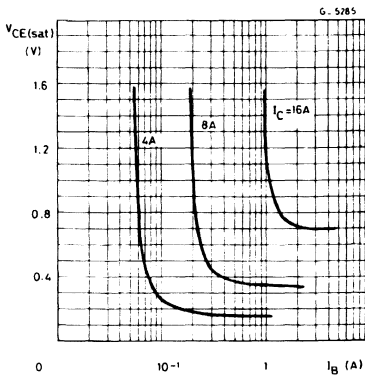

Collector-emitter Saturation Voltage (PNP type).

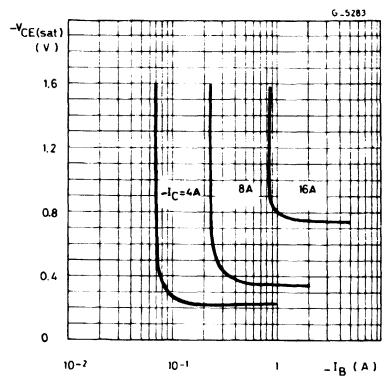

Collector-emitter Saturation Voltage (PNP type).

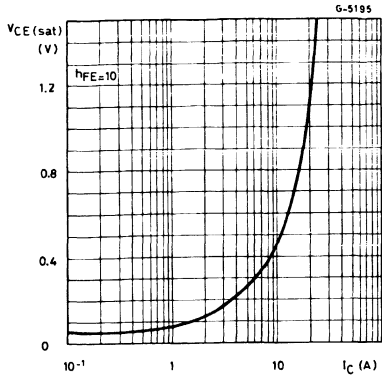

Capacitances (NPN type)

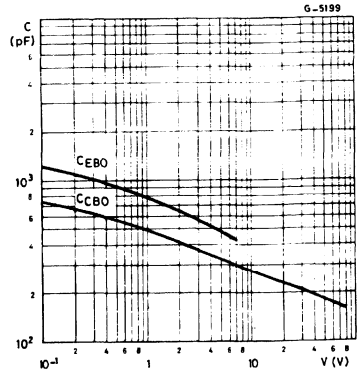

Capacitances (PNP type).

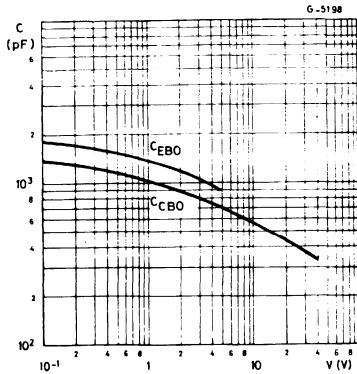

Turn-on Time (NPN type).

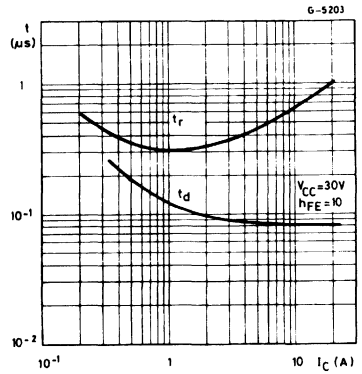

Turn-off Time (NPN type).

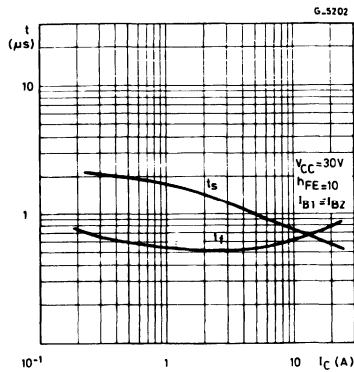

Turn-on Time (PNP type).

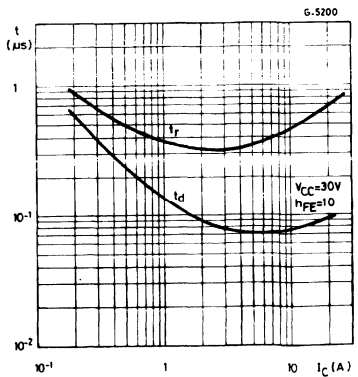

Turn-off Time (PNP type).

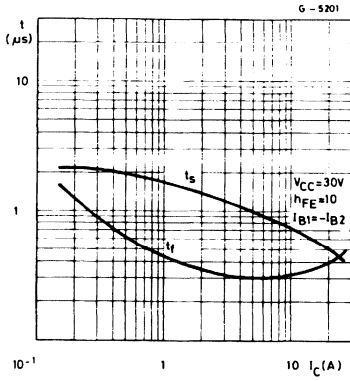

COMPLEMENTARY POWER DARLINGTONS

DESCRIPTION

The MJ900, MJ901, MJ1000 and MJ1001 are silicon epitaxial-base transistors in monolithic Darlington configuration, and are mounted in Jedec TO-3 metal case. They are intended for use in power linear and switching applications.

The PNP types are the MJ900 and MJ901 and their complementary NPN types are the MJ1000 and MJ1001 respectively.

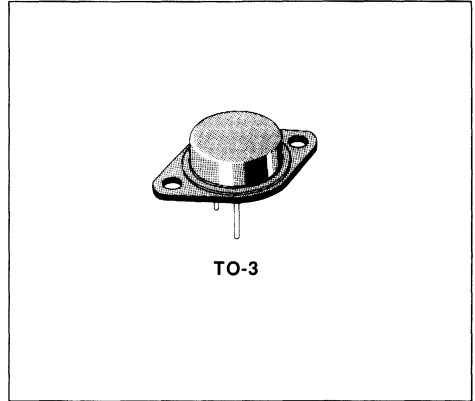

INTERNAL SCHEMATIC DIAGRAMS

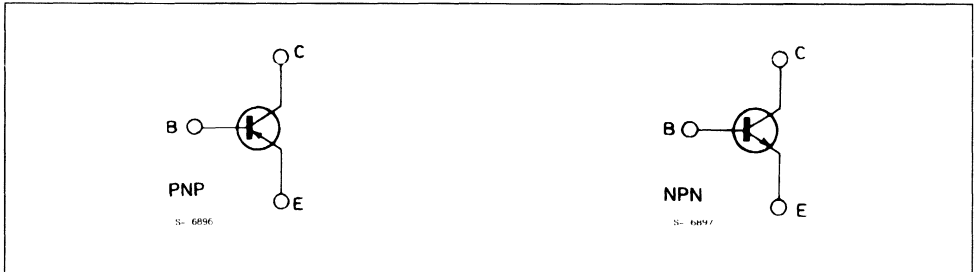

ABSOLUTE MAXIMUM RATINGS

Symbol	Parameter	PNP ^o NPN	Value		Unit
			MJ900 MJ1000	MJ901 MJ1001	
V _{CB0}	Collector-base Voltage (I _E = 0)		60	80	V
V _{CE0}	Collector-emitter Voltage (I _B = 0)		60	80	V
V _{EB0}	Emitter-base Voltage (I _C = 0)		5		V
I _C	Collector Current		8		A
I _B	Base Current		0.1		A
P _{tot}	Total Power Dissipation at T _{case} ≤ 25°C		90		W
T _{stg}	Storage Temperature		- 65 to 200		°C
T _j	Junction Temperature		200		°C

^oFor PNP types voltage and current values are negative.

THERMAL DATA

R _{th j-case}	Thermal Resistance Junction-case	Max	1.94	°C/W
------------------------	----------------------------------	-----	------	------

ELECTRICAL CHARACTERISTICS (T_{case} = 25°C unless otherwise specified)

Symbol	Parameter	Test Conditions	Min.	Typ.	Max.	Unit
I _{CEr}	Collector Cutoff Current (R _{BE} = 1KΩ)	for MJ900 and MJ1000 V _{CE} = 60V for MJ901 and MJ1001 V _{CE} = 80V T _{case} = 150°C for MJ900 and MJ1000 V _{CE} = 60V for MJ901 and MJ1001 V _{CE} = 80V			1 1 5 5	mA mA mA mA
I _{CEO}	Collector Cutoff Current (I _B = 0)	for MJ900 and MJ1000 V _{CE} = 30V for MJ901 and MJ1001 V _{CE} = 40V			0.5 0.5	mA mA
I _{EBO}	Emitter Cutoff Current (I _C = 0)	V _{EB} = 5V			2	mA
V _{CE0(sus)} *	Collector-emitter Sustaining Voltage (I _B = 0)	I _C = 100mA for MJ900 and MJ1000 for MJ901 and MJ1001	60 80			V V
V _{CE(sat)} *	Collector-emitter Saturation Voltage	I _C = 3A I _B = 12mA I _C = 8A I _B = 40mA			2 4	V V
V _{BE} *	Base-emitter Voltage	I _C = 3A V _{CE} = 3V			2.5	V
h _{FE} *	DC Current Gain	I _C = 3A V _{CE} = 3V I _C = 4A V _{CE} = 3V	1000 750			

* Pulsed : pulse duration = 300µs, duty cycle = 1.5%.
For PNP types current and voltage values are negative.
For characteristic curves see the 2N6053/55 series.

COMPLEMENTARY POWER DARLINGTONS

DESCRIPTION

The MJ2500, MJ2501, MJ3000 and MJ3001 are silicon epitaxial-base transistors in monolithic Darlington configuration and are mounted in Jedec TO-3 metal case. They are intended for use in power linear and switching applications.

The PNP types are the MJ2500 and MJ2501 and their complementary NPN types are the MJ3000 and MJ3001 respectively.

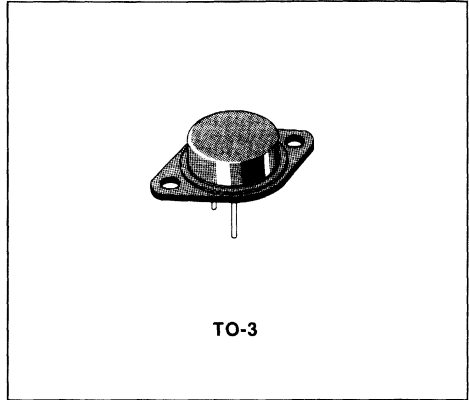

INTERNAL SCHEMATIC DIAGRAMS

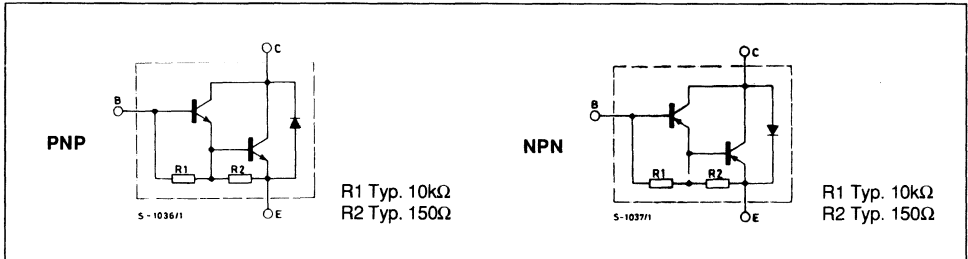

ABSOLUTE MAXIMUM RATINGS

Symbol	Parameter	PNP NPN	Value		Unit
			MJ2500 MJ3000	MJ2501 MJ3001	
V_{CBO}	Collector-base Voltage ($I_E = 0$)		60	80	V
V_{CEO}	Collector-emitter Voltage ($I_B = 0$)		60	80	V
V_{EBO}	Emitter-base Voltage ($I_C = 0$)		5		V
I_C	Collector Current		10		A
I_B	Base Current		0.2		A
P_{tot}	Total Power Dissipation at $T_{case} \leq 25^\circ\text{C}$		150		W
T_{stg}	Storage Temperature		- 65 to 200		$^\circ\text{C}$
T_j	Junction Temperature		200		$^\circ\text{C}$

For PNP types voltage and current values are negative.

THERMAL DATA

$R_{th\ j-case}$	Thermal Resistance Junction-case	Max	1.17	°C/W
------------------	----------------------------------	-----	------	------

ELECTRICAL CHARACTERISTICS ($T_{case} = 25^{\circ}C$ unless otherwise specified)

Symbol	Parameter	Test Conditions	Min.	Typ.	Max.	Unit	
I_{CER}	Collector Cutoff Current ($R_{BE} = 1K\Omega$)	for MJ2500 and MJ3000 $V_{CE} = 60\ V$			1	mA	
		for MJ2501 and MJ3001 $V_{CE} = 80\ V$ $T_{case} = 150\ ^{\circ}C$			1	mA	
		for MJ2500 and MJ3000 $V_{CE} = 60\ V$			5	mA	
		for MJ2501 and MJ3001 $V_{CE} = 80\ V$			5	mA	
I_{CEO}	Collector Cutoff Current ($I_B = 0$)	for MJ2500 and MJ3000 $V_{CE} = 30\ V$			1	mA	
		for MJ2501 and MJ3001 $V_{CE} = 40\ V$			1	mA	
I_{EBO}	Emitter Cutoff Current ($I_C = 0$)	$V_{EB} = 5V$			2	mA	
$V_{CE0(sus)}^*$	Collector-emitter Sustaining Voltage ($I_B = 0$)	$I_C = 100mA$					
		for MJ2500 and MJ3000 for MJ2501 and MJ3001	60 80			V V	
$V_{CE(sat)}^*$	Collector-emitter Saturation Voltage	$I_C = 5A$	$I_B = 20mA$			2	V
		$I_C = 10A$	$I_B = 50mA$			4	V
V_{BE}^*	Base-emitter Voltage	$I_C = 5A$	$V_{CE} = 3V$			3	V
h_{FE}^*	DC Current Gain	$I_C = 5A$	$V_{CE} = 3V$	1000			

* Pulsed : pulse duration = 300 μ s, duty cycle = 1.5%.

For PNP types current and voltage values are negative.

POWER LINEAR AND SWITCHING APPLICATIONS
DESCRIPTION

The MJ2955 is a silicon epitaxial-base PNP power transistor in Jedec TO-3 metal case. It is intended for power switching circuits, series and shunt regulators, output stages and hi-fi amplifiers.

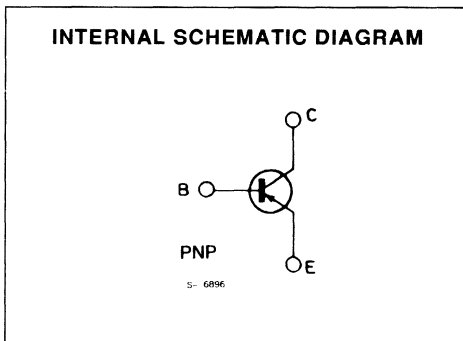
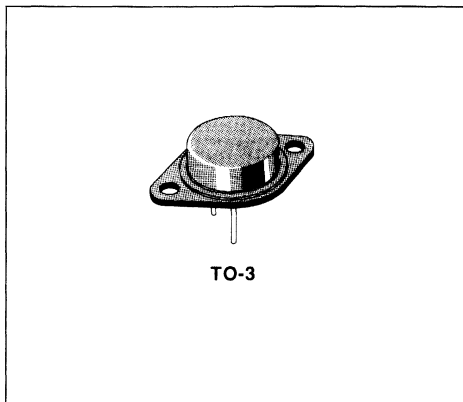
ABSOLUTE MAXIMUM RATINGS

Symbol	Parameter	Value	Unit
V_{CBO}	Collector-base Voltage ($I_E = 0$)	- 100	V
V_{CER}	Collector-emitter Voltage ($R_{BE} \leq 100\Omega$)	- 70	V
V_{CEO}	Collector-emitter Voltage ($I_B = 0$)	- 60	V
V_{EBO}	Emitter-base Voltage ($I_C = 0$)	- 7	V
I_C	Collector Current	- 15	A
I_B	Base Current	- 7	A
P_{Tot}	Total Power Dissipation at $T_{case} \leq 25^\circ C$	150	W
T_{stg}	Storage Temperature	- 65 to 200	$^\circ C$
T_j	Junction Temperature	200	$^\circ C$

THERMAL DATA

$R_{th\ j-case}$	Thermal Resistance Junction-case	Max	1.17	°C/W
------------------	----------------------------------	-----	------	------

ELECTRICAL CHARACTERISTICS ($T_{case} = 25^{\circ}C$ unless otherwise specified)

Symbol	Parameter	Test Conditions	Min.	Typ.	Max.	Unit
I_{CEX}	Collector Cutoff Current ($V_{BE} = 1.5V$)	$V_{CE} = -100V$ $V_{CE} = -100V$ $T_{case} = 150^{\circ}C$			- 1 - 5	mA mA
I_{CEO}	Collector Cutoff Current ($I_B = 0$)	$V_{CE} = -30V$			- 0.7	mA
I_{EBO}	Emitter Cutoff Current ($I_C = 0$)	$V_{EB} = -7V$			-5	mA
$V_{CE(sus)}^*$	Collector-emitter Sustaining Voltage ($R_{BE} = 100\Omega$)	$I_C = -200mA$	- 70			V
$V_{CE(sus)}^*$	Collector-emitter Sustaining Voltage ($I_B = 0$)	$I_C = -200mA$	- 60			V
$V_{CE(sat)}^*$	Collector-emitter Saturation Voltage	$I_C = -4A$ $I_B = -0.4A$ $I_C = -10A$ $I_B = -3.3A$			- 1.1 - 3	V V
V_{BE}^*	Base-emitter Voltage	$I_C = -4A$ $V_{CE} = -4V$			- 1.8	V
h_{FE}^*	DC Current Gain	$I_C = -4A$ $V_{CE} = -4V$ $I_C = -10A$ $V_{CE} = -4V$	20 5		70	
f_T	Transition Frequency	$I_C = -0.5A$ $V_{CE} = -10V$	4			MHz

* Pulsed : pulse duration = 300 μs , duty cycle = 1.5 %.

GENERAL PURPOSE
DESCRIPTION

The MJ4030/31/32/33/34/35 are medium-power silicon NPN Darlington in Jedec TO-3 metal case, intended for use in general purpose and amplifier applications.

The complementary PNP types are the MJ4033/34/35 respectively.

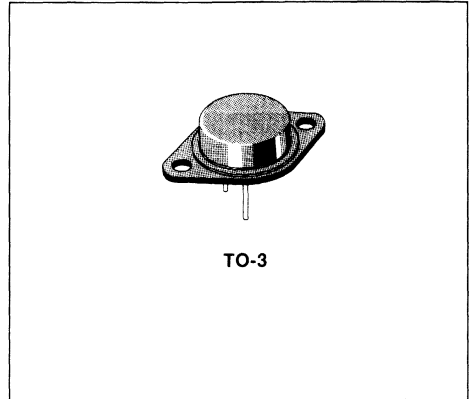
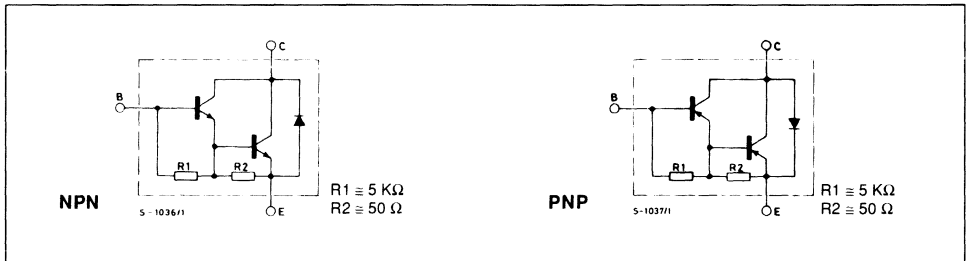
INTERNAL SCHEMATIC DIAGRAMS

ABSOLUTE MAXIMUM RATINGS

Symbol	Parameter	PNP* NPN	Value			Unit
			MJ4030 MJ4033	MJ4031 MJ4034	MJ4032 MJ4035	
V_{CBO}	Collector-base Voltage ($I_E = 0$)		60	80	100	V
V_{CEO}	Collector-emitter Voltage ($I_B = 0$)		60	80	100	V
V_{EBO}	Emitter-base Voltage ($I_C = 0$)		5			V
I_C	Collector Current		16			A
I_B	Base Current		0.5			A
P_{tot}	Total Power Dissipation at $T_{case} \leq 25^\circ\text{C}$		150			W
T_{stg}	Storage Temperature		- 65 to 200			$^\circ\text{C}$
T_j	Junction Temperature		200			$^\circ\text{C}$

* For PNP types voltage and current values are negative.

THERMAL DATA

$R_{th\ j-case}$	Thermal Resistance Junction-case	Max	1.17	°C/W
------------------	----------------------------------	-----	------	------

ELECTRICAL CHARACTERISTICS ($T_{case} = 25^{\circ}C$ unless otherwise specified)

Symbol	Parameter	Test Conditions	Min.	Typ.	Max.	Unit	
I_{CEO}	Collector Cutoff Current ($I_B = 0$)	$V_{CE} = 30V$ $I_B = 0$ MJ4030/33			3	mA	
		$V_{CE} = 40V$ $I_B = 0$ MJ4031/34			3	mA	
		$V_{CE} = 50V$ $I_B = 0$ MJ4032/35			3	mA	
I_{EBO}	Emitter Cutoff Current ($I_C = 0$)	$V_{EB} = 5V$ $I_C = 0$			5	mA	
I_{CER}	Collector Cutoff Current ($R_{BE} = 1K\Omega$)	for MJ4030/33 $V_{CB} = 60V$			1	mA	
		for MJ4031/34 $V_{CB} = 80V$			1	mA	
		for MJ4032/35 $V_{CB} = 100V$			1	mA	
		$T_{case} = 150^{\circ}C$					
		for MJ4030/33 $V_{CB} = 60V$			5	mA	
		for MJ4031/34 $V_{CB} = 80V$			5	mA	
for MJ4032/35 $V_{CB} = 100V$			5	mA			
V_{BRICEO}^*	Collector-emitter Breakdown Voltage	$I_C = 100mA$ $I_B = 0$				V	
		for MJ4030/33	60			V	
		for MJ4031/34	80			V	
		for MJ4032/35	100			V	
$V_{CE(sat)}^*$	Collector-emitter Saturation Voltage	$I_C = 10A$ $I_B = 40mA$			2.5	V	
		$I_C = 16A$ $I_B = 80mA$			4	V	
V_{BE}^*	Base-emitter Voltage	$I_C = 10A$ $V_{CE} = 3V$			3	V	
h_{FE}^*	DC Current Gain	$I_C = 10A$ $V_{CE} = 3V$	1000				

* Pulsed : pulse duration = 300µs, duty cycles ≤ 2%.
For PNP types voltage and current values are negative.

EPITAXIAL PLANAR NPN
DESCRIPTION

The MJ10004/5, MJ10004P/5P and MJ10004PFI/5PFI are silicon epitaxial planar NPN transistors in monolithic Darlington configuration with integrated speed-up diode.

They are mounted respectively in TO-3 metal case, TO-218 plastic package and ISOWATT218 fully isolated package.

They are designed for high power, fast switching applications.

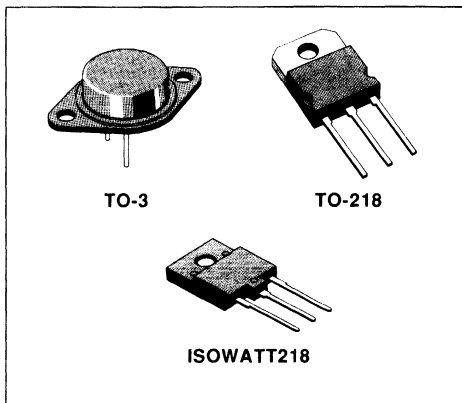
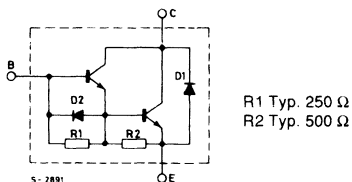
INTERNAL SCHEMATIC DIAGRAM

ABSOLUTE MAXIMUM RATINGS

Symbol	Parameter	MJ10004/4P/4PFI	MJ10005/5P/5PFI	Unit	
V_{CEX}	Collector-emitter Voltage ($V_{BE} = -5V$)	350	400	V	
V_{CEV}	Collector-emitter Voltage ($V_{BE} = 1.5V$)	400	450	V	
V_{CEO}	Collector-emitter Voltage ($I_B = 0$)	450	500	V	
V_{EBO}	Emitter-base Voltage ($I_C = 0$)	8		V	
I_C	Collector Current	20		A	
I_{CM}	Collector Peak Current	30		A	
I_B	Base Current	2.5		A	
I_{BM}	Base Peak Current	5		A	
		TO-3	TO-218	ISOWATT218	
P_{Tot}	Total Power Dissipation at $T_c \leq 25^\circ C$	175	125	60	W
T_{stg}	Storage Temperature	- 65 to 200	- 65 to 150	- 65 to 150	$^\circ C$
T_j	Max. Operating Junction Temperature	200	150	150	$^\circ C$

THERMAL DATA

			TO-3	TO-218	ISOWATT218	
$R_{th\ j-case}$	Thermal Resistance Junction-case	Max	1	1	2.08	°C/W

ELECTRICAL CHARACTERISTICS ($T_{case} = 25^{\circ}C$ unless otherwise specified)

Symbol	Parameter	Test Conditions	Min.	Typ.	Max.	Unit
I_{CEr}	Collector Cutoff Current ($R_{BE} = 50\Omega$)	$V_{CE} = \text{Rated } V_{CEV}$ $T_{case} = 100^{\circ}C$			5	mA
I_{CEV}	Collector Cutoff Current ($V_{BE} = 1.5V$)	$V_{CEV} = \text{Rated Value}$ $V_{CEV} = \text{Rated Value}$ $T_{case} = 150^{\circ}C$			0.25 5	mA mA
I_{EB0}	Emitter Cutoff Current ($I_C = 0$)	$V_{EB} = 2V$			175	mA
$V_{CE0(sus)^*}$	Collector-emitter Sustaining Voltage ($I_B = 0$)	$I_C = 250mA$ $V_{clamp} = \text{Rated } V_{CEO}$ for MJ10004/4P/4PFI for MJ10005/5P/4PFI	350 400			V V
$V_{CEX(sus)^*}$	Collector-emitter Sustaining Voltage ($V_{BE} = -5V$)	$I_C = 2A$ $V_{clamp} = \text{Rated } V_{CEX}$ $T_{case} = 100^{\circ}C$ for MJ10004/4P/4PFI for MJ10005/5P/5PFI $I_C = 10A$ $T_{case} = 100^{\circ}C$ $V_{clamp} = \text{Rated } V_{CEX}$ for MJ10004/4P/4PFI for MJ10005/5P/5PFI	400 450 275 325			V V V V
$V_{CE(sat)^*}$	Collector-emitter Saturation Voltage	$I_C = 10A$ $I_B = 400mA$ $I_C = 20A$ $I_B = 2A$ $I_C = 10A$ $I_B = 400mA$ $T_{case} = 100^{\circ}C$			1.9 3 2.5	V V V
$V_{BE(sat)^*}$	Base-emitter Saturation Voltage	$I_C = 10A$ $I_B = 400mA$ $I_C = 10A$ $I_B = 400mA$ $T_{case} = 100^{\circ}C$			2.5 2.5	V V
h_{FE}^*	DC Current Gain	$I_C = 5A$ $V_{CE} = 5V$ $I_C = 10A$ $V_{CE} = 5V$	50 40		600 400	
V_F^*	Diode Forward Voltage	$I_F = 10A$		1.8	5	V
h_{fe}	Small-signal Current Gain	$I_C = 1A$ $V_{CE} = 10V$ $f = 1MHz$	10			
C_{ob}	Output Capacitance	$V_{CB} = 10V$ $I_E = 0$ $f = 100MHz$	100		325	pF
t_{on}	Turn-on Time	$V_{CC} = 250V$ $I_C = 10A$ $I_{B1} = -I_{B2} = 400mA$		0.5	0.8	μs
t_s	Storage Time	$V_{BE(off)} = 5V$		1	1.5	μs
t_f	Fall Time	$t_p = 50\mu s$ Duty Cycle - 2%		0.3	0.5	μs

COMPLEMENTARY POWER DARLINGTONS

DESCRIPTION

The MJ11011/12/13/14/15/16 are epitaxial-base silicon transistors in monolithic Darlington configuration in JEDEC TO-3 metal case. They are intended for general purpose and amplifier applications.

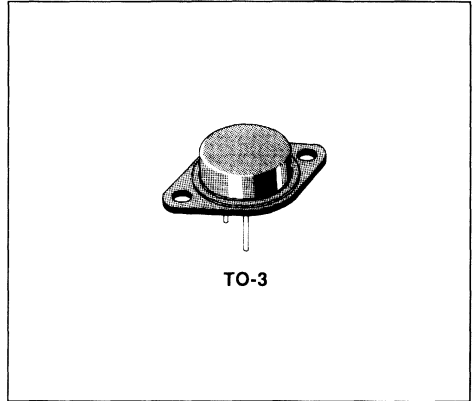

INTERNAL SCHEMATIC DIAGRAMS

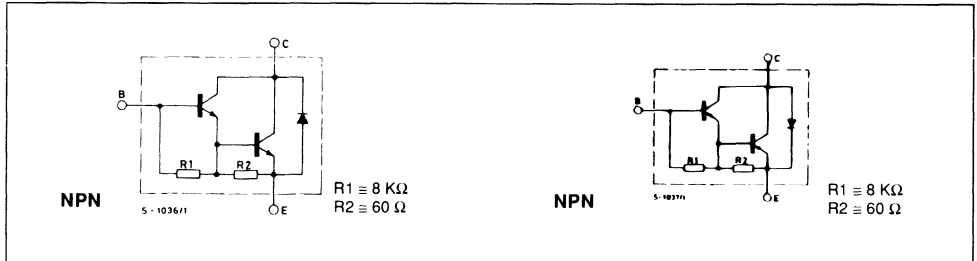

ABSOLUTE MAXIMUM RATINGS

Symbol	Parameter	PNP NPN	Value			Unit
			MJ11011 MJ11012	MJ11013 MJ11014	MJ11015 MJ11016	
V_{CEO}	Collector-emitter Voltage ($I_B = 0$)		60	90	120	V
V_{CBO}	Collector-base Voltage ($I_E = 0$)		60	90	120	V
V_{EBO}	Base-emitter Voltage ($I_C = 0$)		5			V
I_C	Collector Current		30			A
I_B	Base Current		1			A
P_{tot}	Total Power Dissipation at $T_{case} \leq 25^\circ\text{C}$		200			W
T_{stg}	Storage Temperature		- 65 to 200			$^\circ\text{C}$
T_j	Junction Temperature		200			$^\circ\text{C}$

For PNP types voltage and current values are negative.

THERMAL DATA

$R_{th\ j-case}$	Thermal Resistance Junction-case	Max	0.87	$^{\circ}C/W$
------------------	----------------------------------	-----	------	---------------

ELECTRICAL CHARACTERISTICS ($T_{case} = 25^{\circ}C$ unless otherwise specified)

Symbol	Parameter	Test Conditions	Min.	Typ.	Max.	Unit
I_{CEO}	Collector Cutoff Current ($I_B = 0$)	$V_{CE} = 50V$			1	mA
I_{EBO}	Emitter Cutoff Current ($I_C = 0$)	$V_{EB} = 5V$			5	mA
I_{CER}	Collector Cutoff Current ($R_{BE} = 1K\Omega$)	$V_{CE} = \text{Rated } V_{CEO}$ $T_{case} = 150^{\circ}C$ $V_{CE} = \text{Rated } V_{CEO}$			1	mA
$V_{CE0(sus)}^*$	Collector-emitter Sustaining Voltage ($I_B = 0$)	$I_C = 100mA$ MJ11011, MJ11012 MJ11013, MJ11014 MJ11015, MJ11016	60 90 120			V V V
h_{FE}^*	DC Current Gain	$I_C = 20A$ $V_{CE} = 5V$ $I_C = 30A$ $V_{CE} = 5V$	1000 200			
$V_{CE(sat)}^*$	Collector-emitter Saturation Voltage	$I_C = 20A$ $I_B = 200mA$ $I_C = 30A$ $I_B = 300mA$			3 4	V V
$V_{BE(sat)}^*$	Base-emitter Saturation Voltage	$I_C = 20A$ $I_B = 200mA$ $I_C = 30A$ $I_B = 300mA$			3.5 5	V V
h_{te}	Small Signal Current Gain	$I_C = 10A$ $f = 1MHz$ $V_{CE} = 3V$	4			

* Pulsed : pulse duration = 300 μs , duty cycles $\leq 1.5\%$.
For PNP types voltage and current values are negative.

Safe Operating Areas.

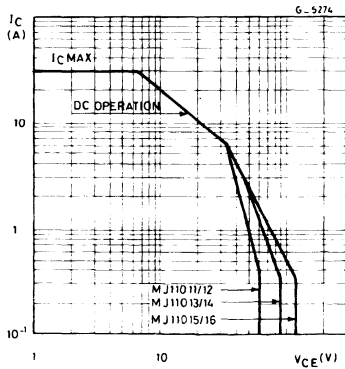

DC Current Gain (NPN types).

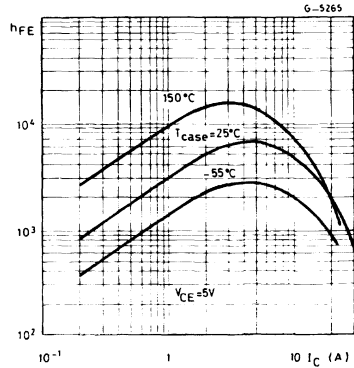

DC Current Gain (PNP types).

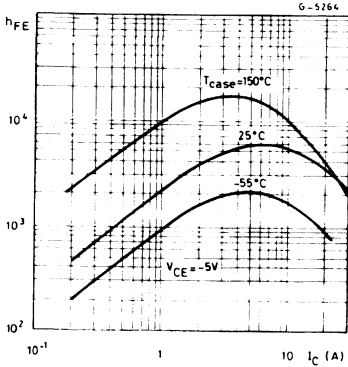

Saturation Voltages (NPN types).

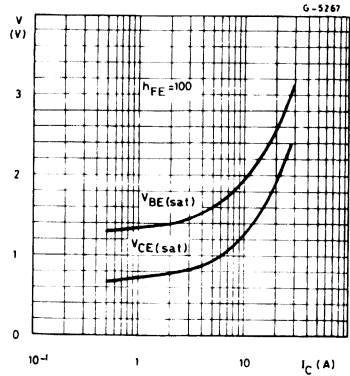

Saturation Voltages (PNP types).

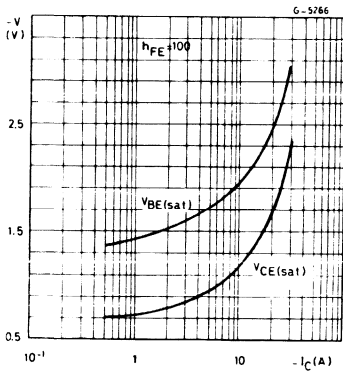

Collector-emitter Saturation Voltage (NPN types).

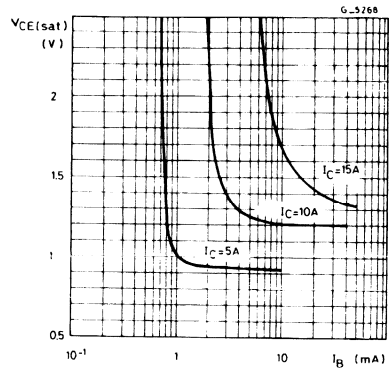

Collector-emitter Saturation Voltage (PNP types).

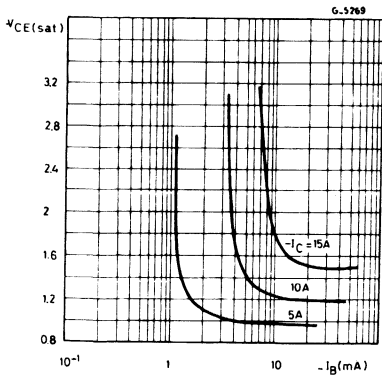

Small Signal Current Gain (NPN types).

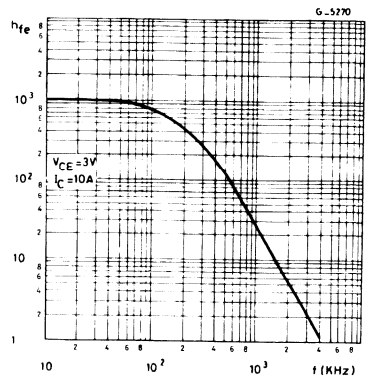

Small Signal Current Gain (PNP types).

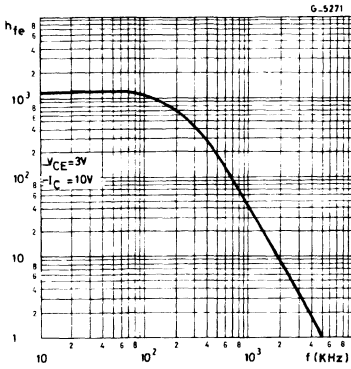

Capacitances (NPN types).

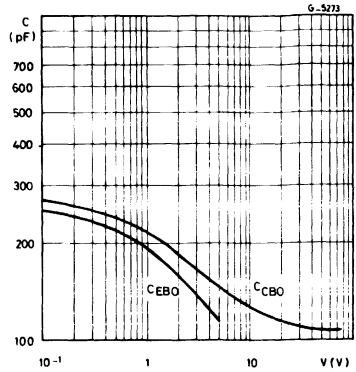

Capacitances (PNP types).

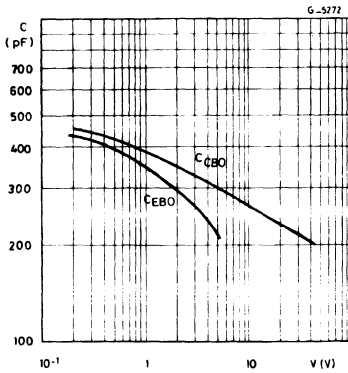

Saturated Switching Times (NPN types).

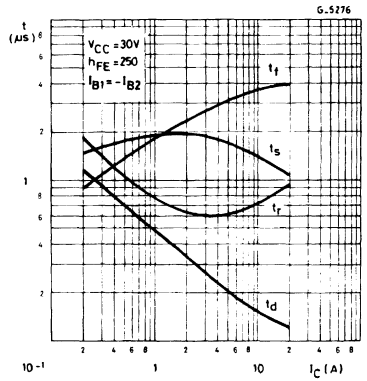

Saturated Switching Times (PNP types).

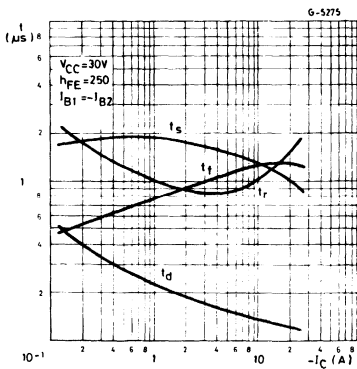

COMPLEMENTARY POWER TRANSISTORS

DESCRIPTION

The MJE 170, MJE171, MJE172 (PNP types) and MJE180, MJE181, MJE182 (NPN types) are silicon epitaxial planar, complementary transistors in Jedec TO-126 plastic package, they are designed for low power audio amplifier and low current, high speed switching applications.

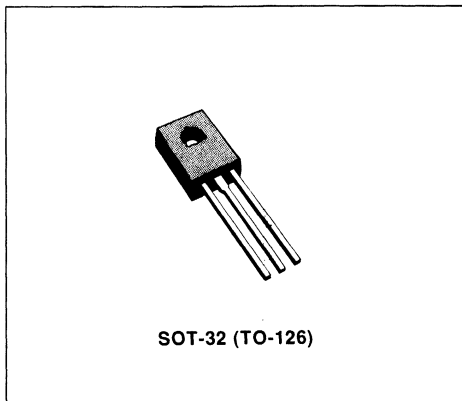

INTERNAL SCHEMATIC DIAGRAMS

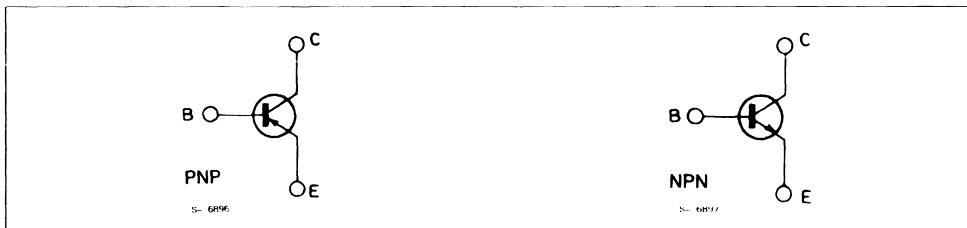

ABSOLUTE MAXIMUM RATINGS

Symbol	Parameter	PNP NPN	Value			Unit
			MJE170 MJE180	MJE171 MJE181	MJE172 MJE182	
V_{CE0}	Collector-emitter Voltage ($I_B = 0$)		40	60	80	V
V_{CB0}	Collector-base Voltage ($I_E = 0$)		60	80	100	V
V_{EB0}	Base-emitter Voltage ($I_C = 0$)		7			V
I_C	Collector Current		3			A
I_{CM}	Collector Peak Current		6			A
I_B	Base Current		1			A
P_{tot}	Total Power Dissipation at $T_{case} \leq 25^\circ C$		12.5			W
T_{stg}	Storage Temperature		- 65 to 150			$^\circ C$
T_j	Junction Temperature		150			$^\circ C$

For PNP types voltage and current values are negative.

THERMAL DATA

$R_{th\ j-amb}$	Thermal Resistance Junction-ambient	Max	83.4	°C/W
$R_{th\ j-case}$	Thermal Resistance Junction-case	Max	10	°C/W

ELECTRICAL CHARACTERISTICS ($T_{case} = 25^{\circ}C$ unless otherwise specified)

Symbol	Parameter	Test Conditions	Min.	Typ.	Max.	Unit
I_{CBO}	Collector Cutoff Current ($I_E = 0$)	$V_{CB} = \text{rated } V_{CBO}$ $T_{case} = 150^{\circ}C$			0.1 0.1	μA mA
I_{EBO}	Emitter Cutoff Current ($I_C = 0$)	$V_{EB} = 7\ V$			0.1	μA
$V_{CEO(sus)}^*$	Collector-emitter Sustaining Voltage	$I_C = 10\ mA$ for MJE170, MJE180 for MJE171, MJE181 for MJE172, MJE182	40 60 80			V V V
$V_{CE(sat)}^*$	Collector-emitter Saturation Voltage	$I_C = 0.5A$ $I_B = 50mA$ $I_C = 1.5A$ $I_B = 0.15A$ $I_C = 3A$ $I_B = 0.6A$			0.3 0.9 1.7	V V V
$V_{BE(sat)}^*$	Base-emitter Saturation Voltage	$I_C = 1.5A$ $I_B = 0.15A$ $I_C = 3A$ $I_B = 0.6A$			1.5 2	V V
V_{BE}^*	Base-emitter Voltage	$I_C = 0.5A$ $V_{CE} = 1V$			1.2	V
h_{FE}^*	DC Current Gain	$I_C = 0.1A$ $V_{CE} = 1V$ $I_C = 0.5A$ $V_{CE} = 1V$ $I_C = 1.5A$ $V_{CE} = 1V$	50 30 12		250	
f_T	Transition Frequency	$I_C = 0.1A$ $V_{CE} = 10V$ $f = 10MHz$	50			MHz
C_{CBO}	Collector-base Capacitance	$V_{CB} = 10V$; $I_E = 0$; $f = 0.1MHz$ for MJE170, MJE172 for MJE180, MJE182			60 40	pF pF

* Pulsed : pulse duration = 300 μs , duty cycle $\leq 1.5\%$.
For PNP types voltage and current values are negative.

Safe Operating Areas.

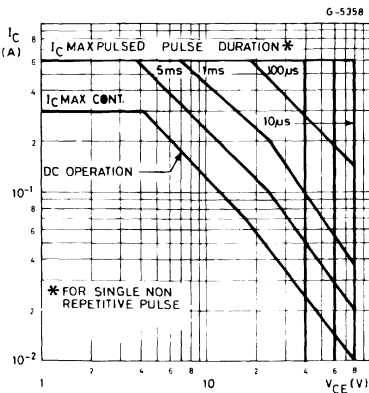

DC Current Gain (NPN types)

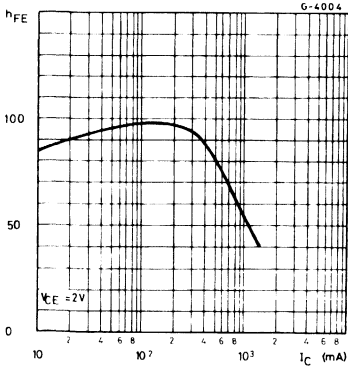

DC Current Gain (PNP types)

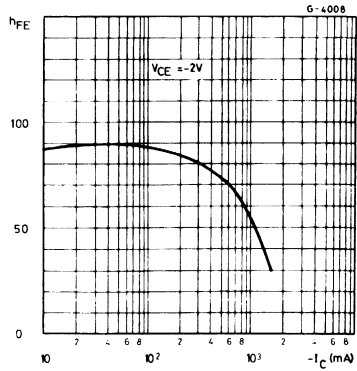

Collector-emitter saturation voltage (NPN types).

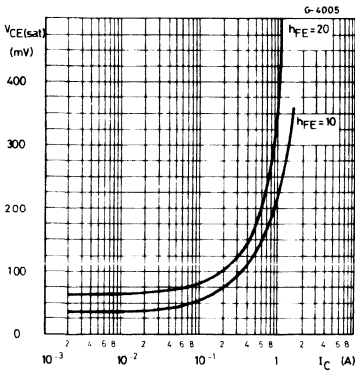

Collector-emitter Saturation Voltage (PNP types).

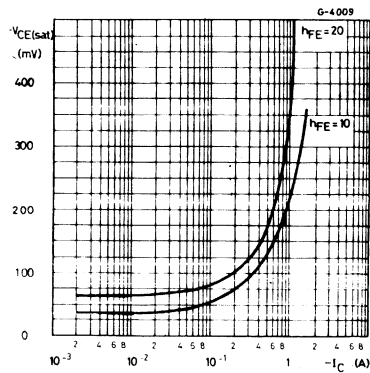

Base-emitter Voltage (NPN types).

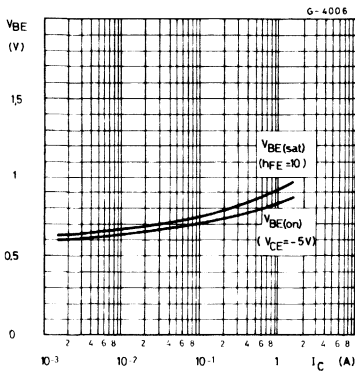

Base-emitter Voltage (PNP types).

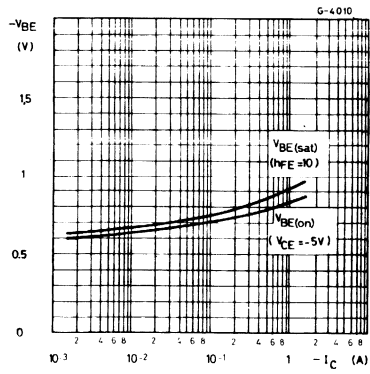

COMPLEMENTARY POWER TRANSISTORS

DESCRIPTION

The MJE200 (NPN type) and MJE210 (PNP type) are silicon epitaxial-base transistors in Jedec TO-126 plastic package, designed for low voltage, low power, high gain audio amplifier applications.

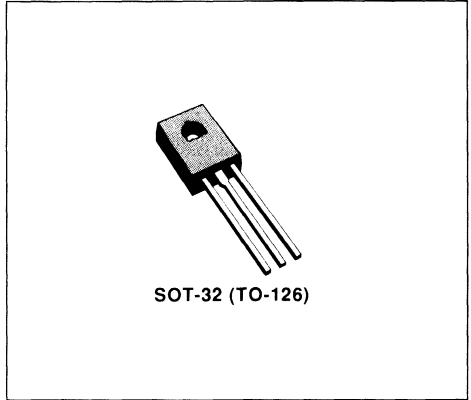

INTERNAL SCHEMATIC DIAGRAMS

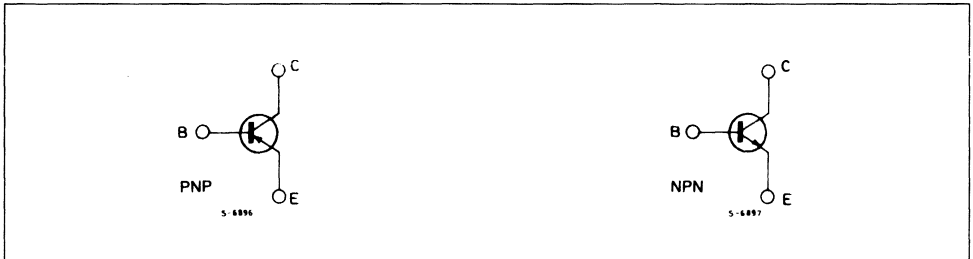

ABSOLUTE MAXIMUM RATINGS

Symbol	Parameter	Value	Unit
V_{CBO}	Collector-base Voltage ($I_E = 0$)	40	V
V_{CEO}	Collector-emitter Voltage ($I_B = 0$)	25	V
V_{EBO}	Emitter-base Voltage ($I_C = 0$)	8	V
I_C	Collector Current	5	A
I_{CM}	Collector Peak Current	10	A
I_B	Base Current	1	A
P_{tot}	Total Power Dissipation at $T_{case} \leq 25^\circ\text{C}$ at $T_{amb} \leq 25^\circ\text{C}$	15 1.5	W W
T_{stg}	Storage Temperature	- 65 to 150	$^\circ\text{C}$
T_j	Junction Temperature	150	$^\circ\text{C}$

For PNP type voltage and current values are negative.

THERMAL DATA

$R_{th\ j-amb}$	Thermal Resistance Junction-ambient	Max	83.4	°C/W
$R_{th\ j-case}$	Thermal Resistance Junction-case	Max	8.34	°C/W

ELECTRICAL CHARACTERISTICS ($T_{case} = 25^{\circ}C$ unless otherwise specified)

Symbol	Parameter	Test Conditions		Min.	Typ.	Max.	Unit
I_{CBO}	Collector Cutoff Current ($I_E = 0$)	$V_{CB} = 40V$ $V_{CB} = 40V$	$T_{case} = 125^{\circ}C$			100 100	nA μA
I_{EBO}	Emitter Cutoff Current ($I_C = 0$)	$V_{EB} = 8V$				100	nA
$V_{CE0(sus)*}$	Collector-emitter Sustaining Voltage	$I_C = 10mA$		25			V
$V_{CE(sat)*}$	Collector-emitter Saturation Voltage	$I_C = 0.5A$ $I_C = 2A$ $I_C = 5A$	$I_B = 50mA$ $I_B = 0.2A$ $I_B = 1A$			0.3 0.75 1.8	V V V
$V_{BE(sat)*}$	Base-emitter Saturation Voltage	$I_C = 5A$	$I_B = 1A$			2.5	V
V_{BE}^*	Base-emitter Voltage	$I_C = 2A$	$V_{CE} = 1V$			1.6	V
h_{FE}^*	DC Current Gain	$I_C = 0.5A$ $I_C = 2A$ $I_C = 5A$	$V_{CE} = 1V$ $V_{CE} = 1V$ $V_{CE} = 2V$	70 45 10		180	
f_T	Transition Frequency	$I_C = 0.1A$ $f = 10MHz$	$V_{CE} = 10V$	65			MHz
C_{CBO}	Collector-base Capacitance	$V_{CB} = 10V ; I_E = 0 ; f = 0.1MHz$ for MJE200 for MJE201				80 120	pF pF

* Pulsed : pulse duration = 300 μs , duty cycle $\leq 1.5\%$.
For PNP type voltage and current values are negative.

Safe Operating Areas.

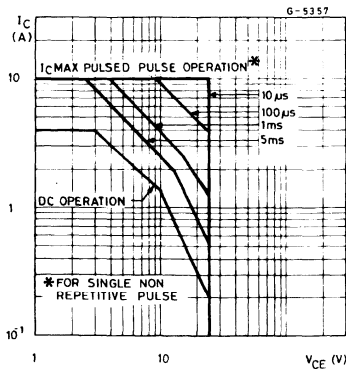

DC Current Gain (NPN type).

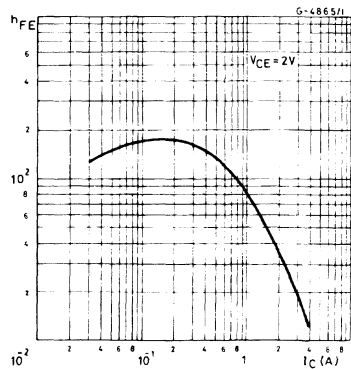

DC Current Gain (PNP type).

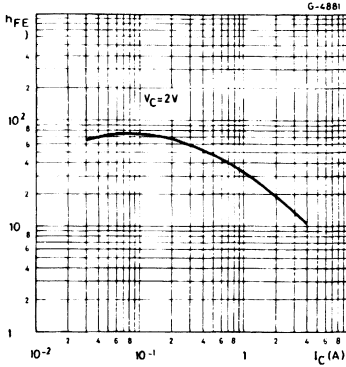

DC Transconductance (NPN type).

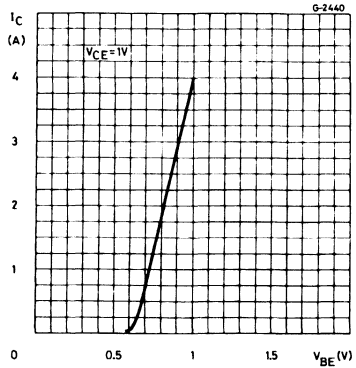

DC Transconductance (PNP type).

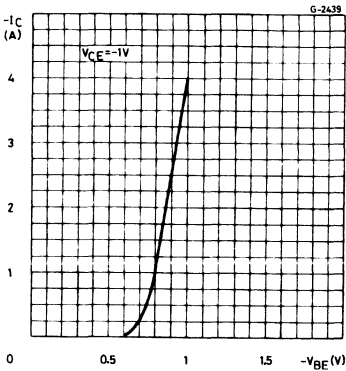

Collector-emitter Saturation Voltage (NPN type).

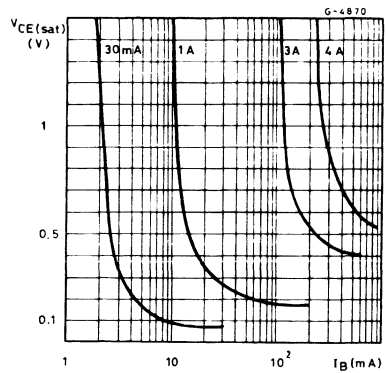

Collector-emitter Saturation Voltage (PNP type).

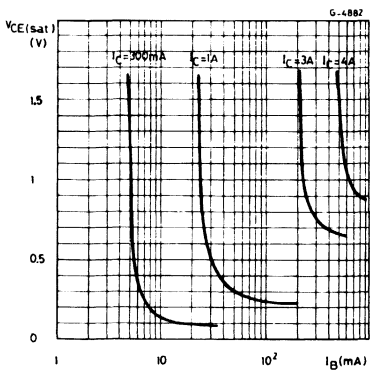

Transition Frequency (NPN type).

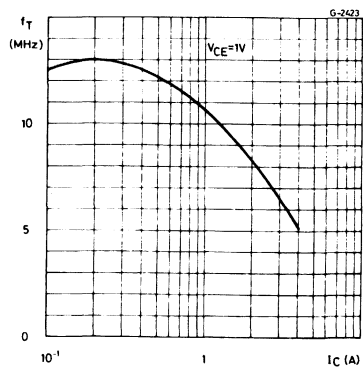

Transition Frequency (PNP type).

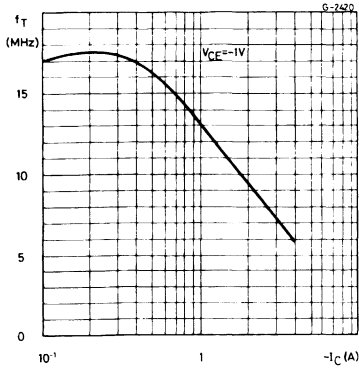

Collector-base Capacitance (NPN type).

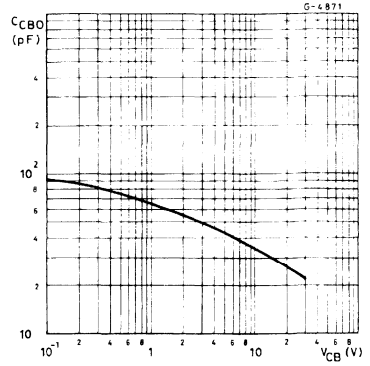

Collector-base Capacitance (PNP type).

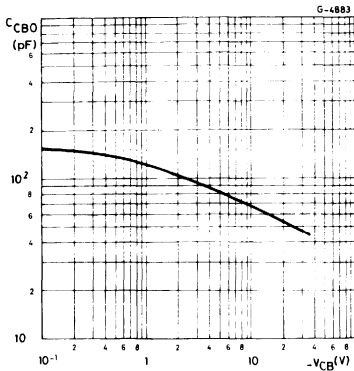

Saturated Switching Characteristics (NPN type).

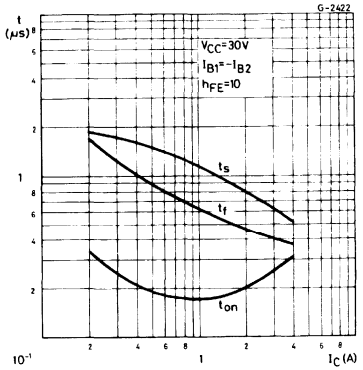

Saturated Switching Characteristics (PNP type).

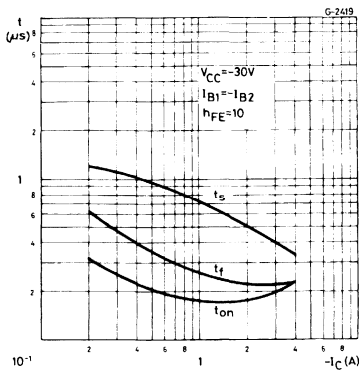

HIGH VOLTAGE POWER TRANSISTORS

DESCRIPTION

The MJE340, MJE340T, SGS340 are silicon epitaxial planar NPN transistors intended for use in medium power linear and switching applications. They are respectively mounted in TO-125, TO-220 and SOT-82 package.

The complementary PNP types are respectively the MJE350, MJE350T, SGS350.

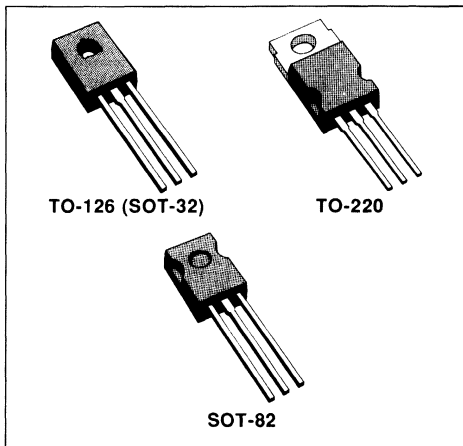

INTERNAL SCHEMATIC DIAGRAMS

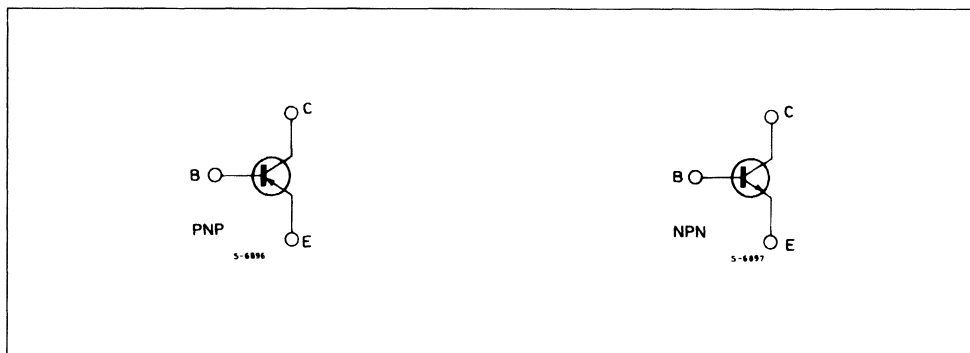

ABSOLUTE MAXIMUM RATINGS

Symbol	Parameter	Value	Unit
V_{CEO}	Collector-emitter Voltage ($I_B = 0$)	300	V
V_{EBO}	Emitter-base Voltage ($I_C = 0$)	3	V
I_C	Collector Current	0.5	A
P_{tot}	Total Power Dissipation at $T_{case} \leq 25^\circ\text{C}$	20.8	W
T_{stg}	Storage Temperature	- 65 to 150	$^\circ\text{C}$
T_J	Junction Temperature	150	$^\circ\text{C}$

THERMAL DATA

$R_{th(j-case)}$	Thermal Resistance Junction-case	Max	6.0	$^{\circ}C/W$
------------------	----------------------------------	-----	-----	---------------

ELECTRICAL CHARACTERISTICS ($T_{case} = 25^{\circ}C$ unless otherwise specified)

Symbol	Parameter	Test Conditions	Min.	Typ.	Max.	Unit
I_{CBO}	Collector Cutoff Current ($I_E = 0$)	$V_{CB} = 300V$			100	μA
I_{EBO}	Emitter Cutoff Current ($I_C = 0$)	$V_{EB} = 3V$			100	μA
$V_{CEO(sus)^*}$	Collector-Emitter Sustaining Voltage ($I_B = 0$)	$I_C = 1mA$	300			V
h_{FE}	DC Current Gain	$I_C = 50mA$ $V_{CE} = 10V$	30		240	

* Pulsed : pulse duration = 300 μs , duty cycle $\leq 2\%$.

Safe Operating Areas.

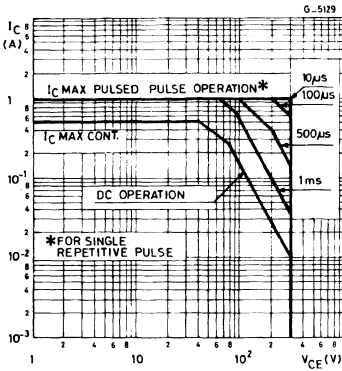

DC Current Gain (NPN).

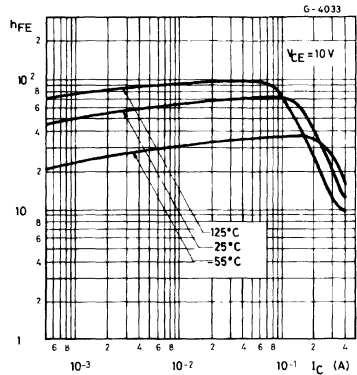

DC Current Gain (PNP).

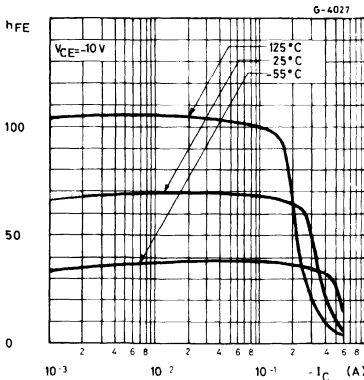

Collector-emitter Saturation Voltage (NPN).

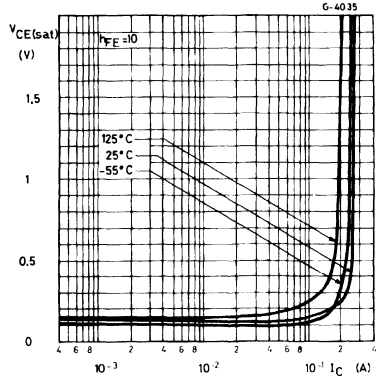

Collector-emitter Saturation Voltage (PNP).

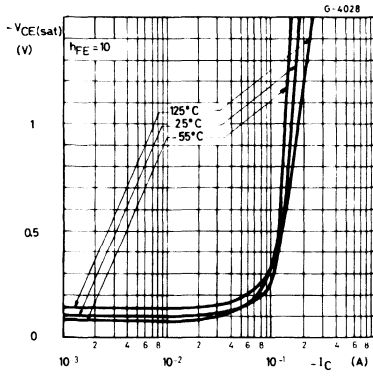



COMPLEMENTARY MEDIUM POWER TRANSISTORS

DESCRIPTION

The MJE370 (PNP type) and the MJE520 (NPN type) are silicon epitaxial-base transistors in Jedec TO-126 plastic package, designed for use in general purpose amplifier and switching circuits.

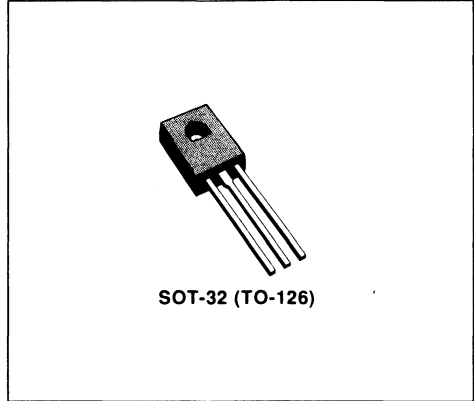

INTERNAL SCHEMATIC DIAGRAMS

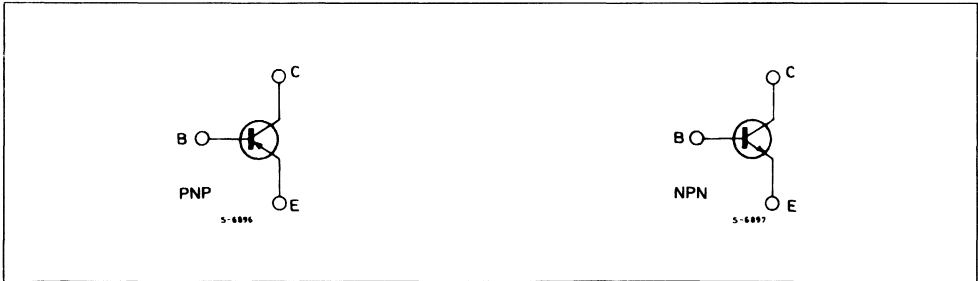

ABSOLUTE MAXIMUM RATINGS

Symbol	Parameter	Value	Unit
V_{CBO}	Collector-base Voltage ($I_E = 0$)	30	V
V_{CEO}	Collector-emitter Voltage ($I_B = 0$)	30	V
V_{EBO}	Emitter-base Voltage ($I_C = 0$)	4	V
I_C	Collector Current	3	A
I_{CM}	Collector Peak Current	7	A
I_B	Base Current	2	A
P_{tot}	Total Power Dissipation at $T_{case} \leq 25^\circ C$	25	W
T_{stg}	Storage Temperature	- 65 to 150	$^\circ C$
T_j	Junction Temperature	150	$^\circ C$

For PNP types voltage and current values are negative.

THERMAL DATA

$R_{th(j-case)}$	Thermal Resistance Junction-case	Max	5	°C/W
------------------	----------------------------------	-----	---	------

ELECTRICAL CHARACTERISTICS ($T_{case} = 25^{\circ}C$ unless otherwise specified)

Symbol	Parameter	Test Conditions	Min.	Typ.	Max.	Unit
I_{CBO}	Collector Cutoff Current ($I_E = 0$)	$V_{CB} = 30V$			100	μA
I_{EBO}	Emitter Cutoff Current ($I_C = 0$)	$V_{EB} = 4V$			100	μA
$V_{CE0(SUS)^*}$	Collector-emitter Sustaining Voltage	$I_C = 100mA$	30			V
h_{FE}^*	DC Current Gain	$I_C = 1A$ $V_{CE} = 1V$	25			

* Pulsed : pulse duration = 300 μs , duty cycle \leq 1.5%.
 For PNP types voltage and current values are negative.

Safe Operating Areas.

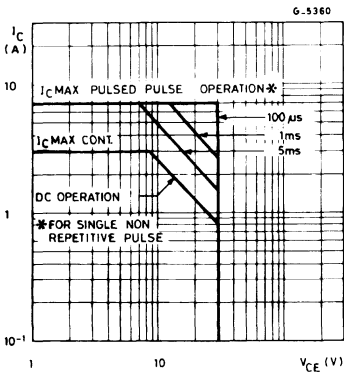

DC Current Gain (NPN type).

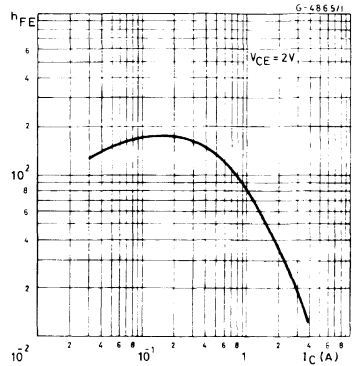

DC Current Gain (PNP type).

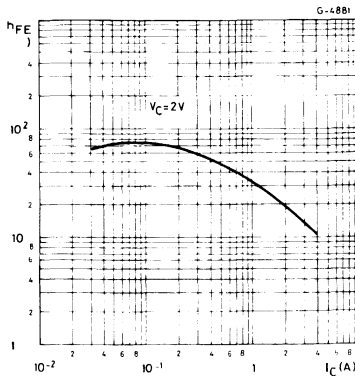

DC Transconductance (NPN type).

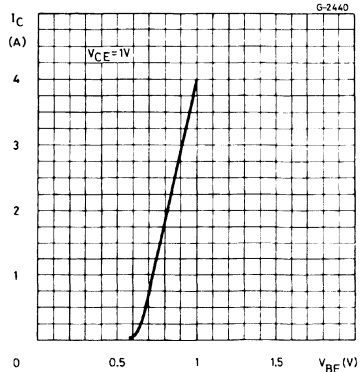

DC Transconductance(PNP type).

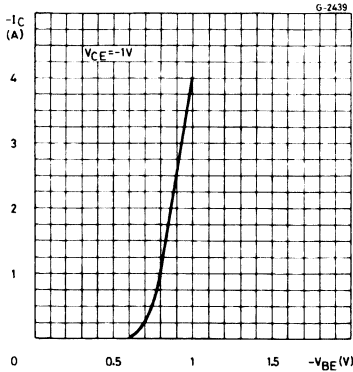

Collector-emitter Saturation Voltage (NPN type).

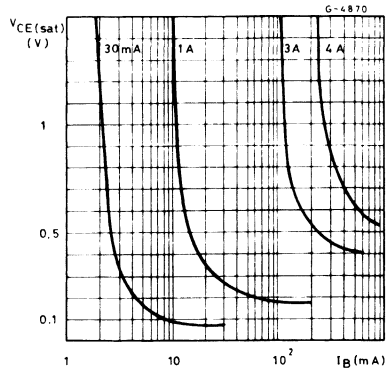

Collector-emitter saturation voltage (PNP type).

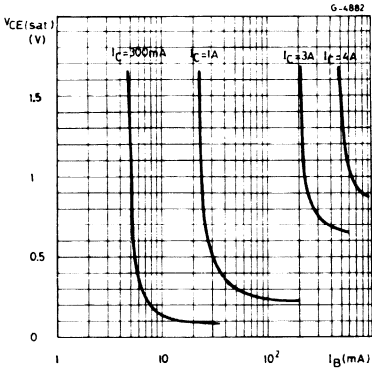

Transition Frequency (NPN type).

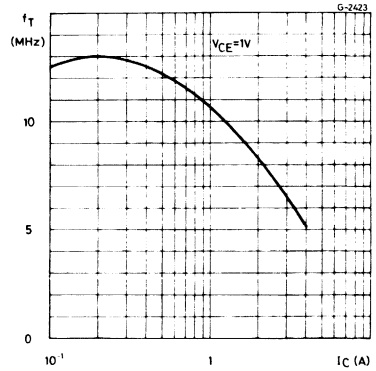

Transition Frequency (PNP type).

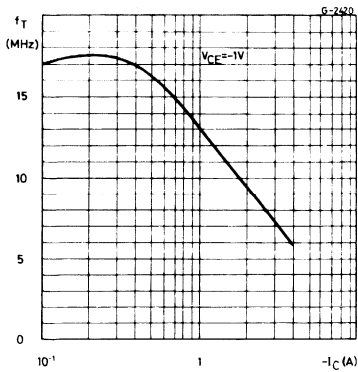

Collector-base Capacitance (NPN type).

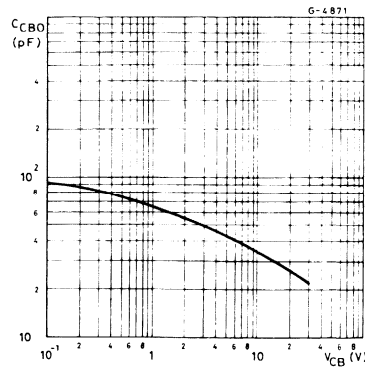

Collector-base Capacitance (PNP type).

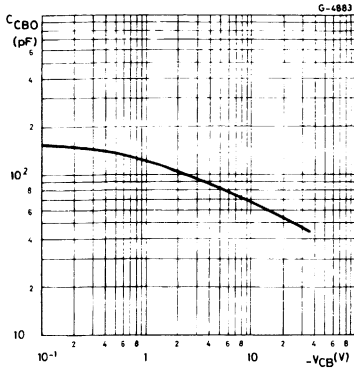

Saturated Switching Characteristics (NPN type).

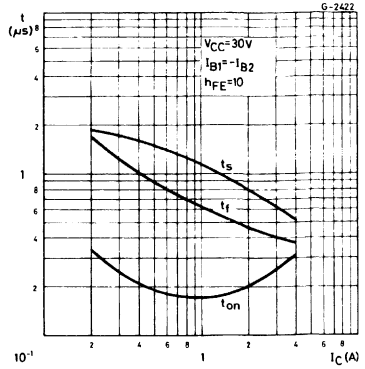

Saturated switching characteristics (PNP types).

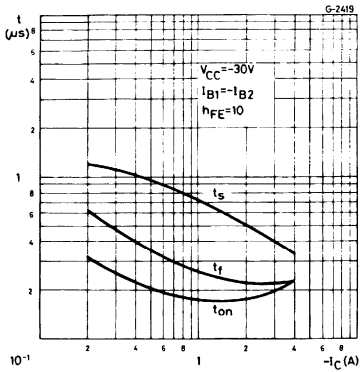

COMPLEMENTARY POWER TRANSISTORS

DESCRIPTION

The MJE521 is a silicon epitaxial-base NPN transistor in Jedec TO-126 plastic package, intended for use in 5 to 20W audio amplifiers, general purpose amplifier and switching circuits. The complementary PNP type is the MJE371.

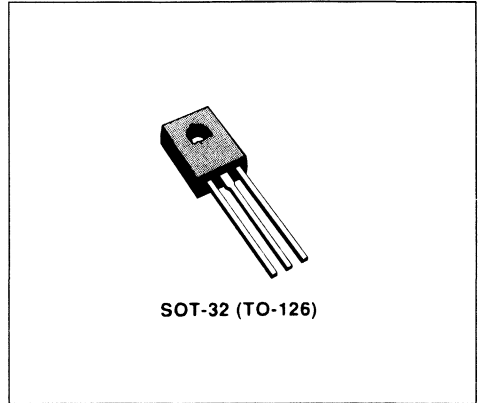

INTERNAL SCHEMATIC DIAGRAMS

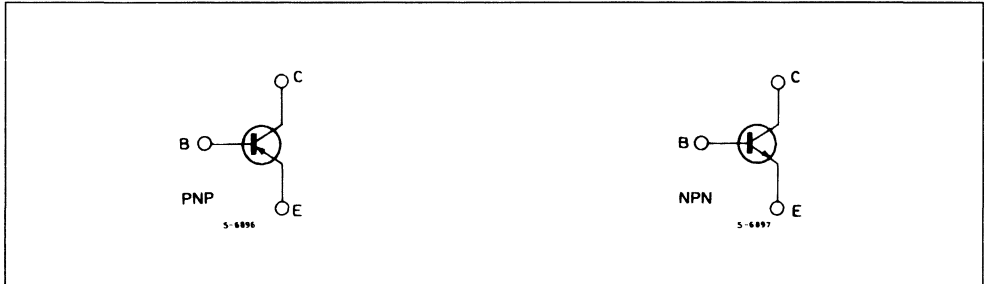

ABSOLUTE MAXIMUM RATINGS

Symbol	Parameter	Value	Unit
V_{CBO}	Collector-base Voltage ($I_E = 0$)	40	V
V_{CEO}	Collector-emitter Voltage ($I_B = 0$)	40	V
V_{EBO}	Emitter-base Voltage ($I_C = 0$)	4	V
I_C	Collector Current	4	A
I_{CM}	Collector Peak Current	8	A
I_B	Base Current	2	A
P_{tot}	Total Power Dissipation at $T_{case} \leq 25^\circ C$	40	W
T_{stg}	Storage Temperature	- 65 to 150	$^\circ C$
T_j	Junction Temperature	150	$^\circ C$

For PNP types voltage and current values are negative.

THERMAL DATA

$R_{th(j-case)}$	Thermal Resistance Junction-case	Max	3.12	°C/W
------------------	----------------------------------	-----	------	------

ELECTRICAL CHARACTERISTICS ($T_{case} = 25^{\circ}C$ unless otherwise specified)

Symbol	Parameter	Test Conditions	Min.	Typ.	Max.	Unit
I_{CBO}	Collector Cutoff Current ($I_E = 0$)	$V_{CB} = 40V$			100	μA
I_{EBO}	Emitter Cutoff Current ($I_C = 0$)	$V_{EB} = 4V$			100	μA
$V_{CE0(sus)}^*$	Collector-Emitter Sustaining Voltage	$I_C = 0.1A$	40			V
h_{FE}^*	DC Current Gain	$I_C = 1A$ $V_{CE} = 1V$	40			

* Pulsed : pulse duration = 300 μs , duty cycle $\leq 1.5\%$.
 For PNP types voltage and current values are negative.

Safe Operating Areas.

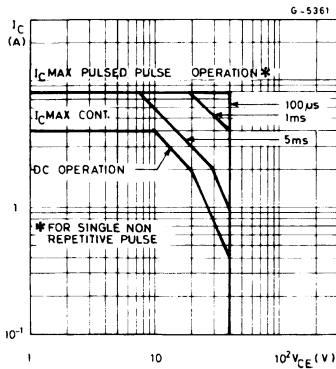

DC Current Gain (NPN type).

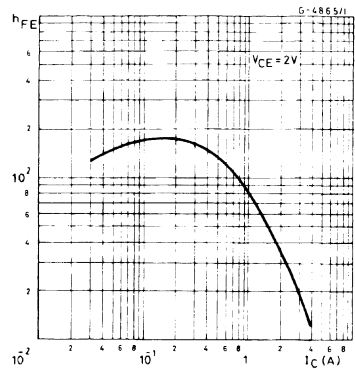

DC Current Gain (PNP type).

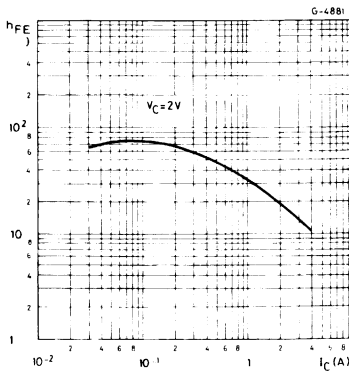

DC Transconductance (NPN type).

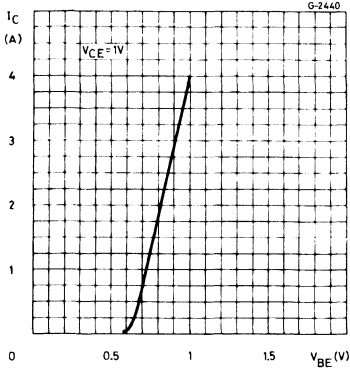

DC Transconductance (PNP type).

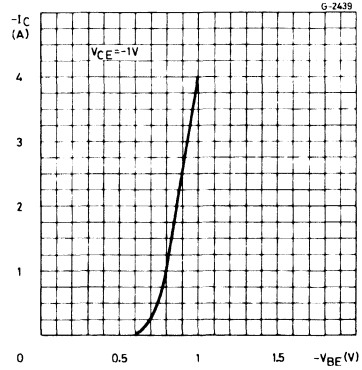

Collector-emitter Saturation Voltage (NPN type).

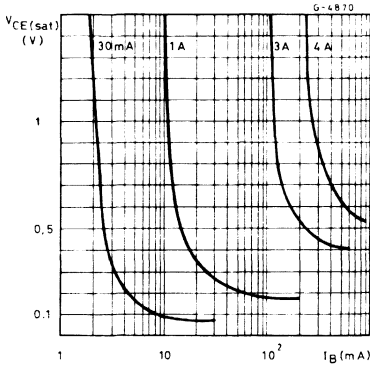

Collector-emitter Saturation Voltage (PNP type).

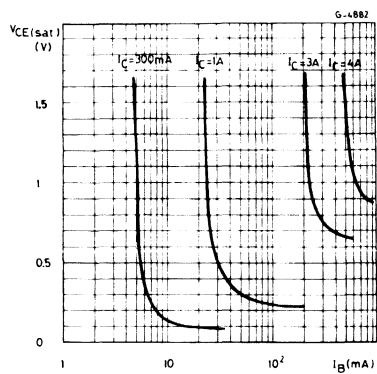

Transition Frequency (NPN type).

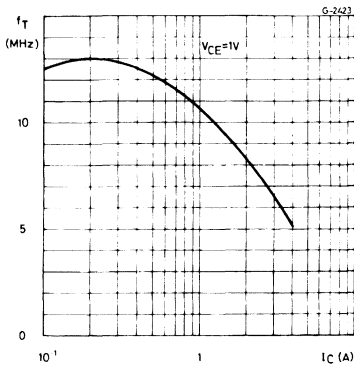

Transition Frequency (PNP type).

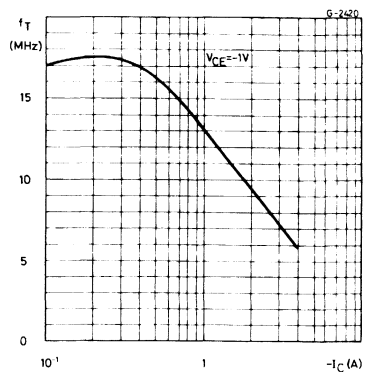

Collector-base Capacitance (NPN type).

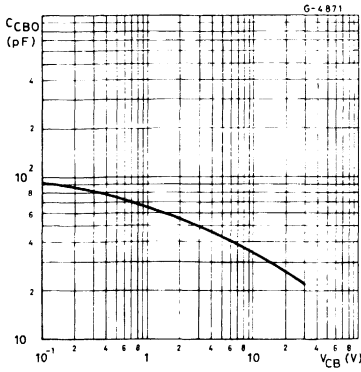

Collector-base Capacitance(PNP type).

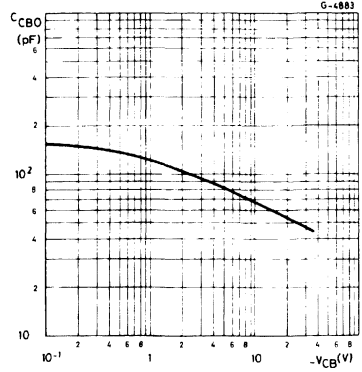

Saturated Switching Characteristics (NPN type).

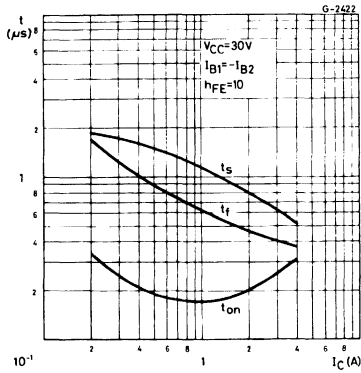

Saturated Switching Characteristics (PNP type).

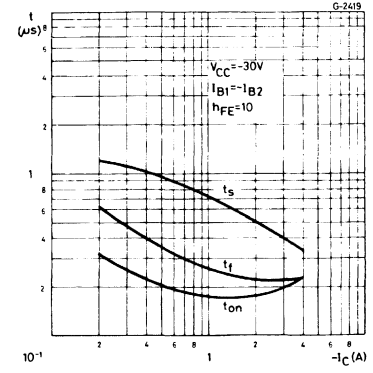

MEDIUM POWER DARLINGTONS

DESCRIPTION

The MJE800, MJE801, MJE802 and MJE803 are silicon epitaxial-base NPN power transistors in monolithic Darlington configuration and are mounted in Jedec TO-126 plastic package. They are intended for use in medium power linear and switching applications.

The complementary PNP types are the MJE700, MJE701, MJE702 and MJE703 respectively.

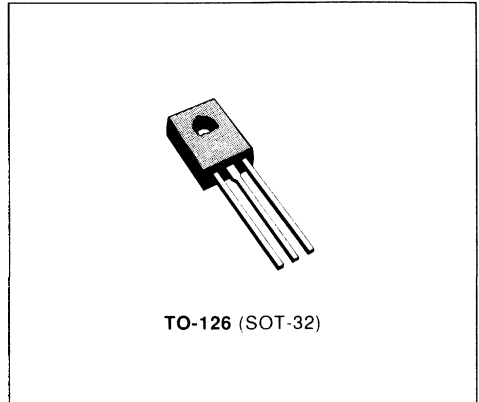

INTERNAL SCHEMATIC DIAGRAMS

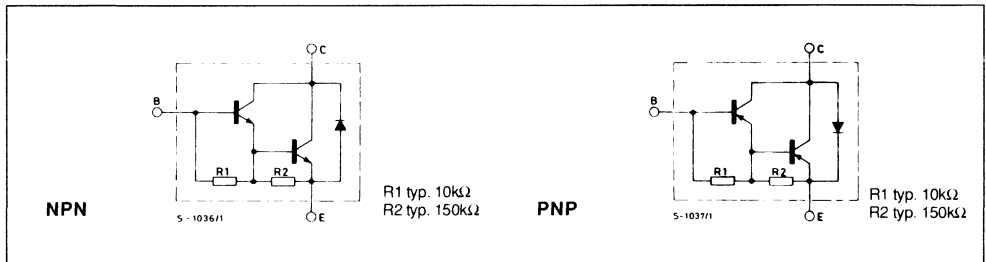

ABSOLUTE MAXIMUM RATINGS

Symbol	Parameter	Value		Unit
		MJE800/1 MJE700/1	MJE802/3 MJE702/3	
V_{CBO}	Collector-base Voltage ($I_E = 0$)	60	80	V
V_{CEO}	Collector-emitter Voltage ($I_B = 0$)	60	80	V
V_{EBO}	Emitter-base Voltage ($I_C = 0$)	5		V
I_C	Collector Current	4		A
I_B	Base Current	0.1		A
P_{tot}	Total Power Dissipation at $T_{case} \leq 25^\circ\text{C}$	40		W
T_{stg}	Storage Temperature	- 65 to 150		$^\circ\text{C}$
T_J	Junction Temperature	150		$^\circ\text{C}$

For PNP types voltage and current values are negative.

THERMAL DATA

$R_{th\ j-case}$	Thermal Resistance Junction-case	Max	3.13	°C/W
------------------	----------------------------------	-----	------	------

ELECTRICAL CHARACTERISTICS ($T_{case} = 25^{\circ}C$ unless otherwise specified)

Symbol	Parameter	Test Conditions	Min.	Typ.	Max.	Unit
I_{CBO}	Collector Cutoff Current ($I_E = 0$)	$V_{CB} = \text{rated } V_{CBO}$ $V_{CB} = \text{rated } V_{CBO}$ $T_{case} = 100^{\circ}C$			100 500	μA μA
I_{CEO}	Collector Cutoff Current ($I_B = 0$)	$V_{CE} = \text{rated } V_{CEO}$			100	μA
I_{EBO}	Emitter Cutoff Current ($I_C = 0$)	$V_{EB} = 5V$			2	mA
$V_{CEO(sus)}^*$	Collector-emitter Sustaining Voltage ($I_B = 0$)	$I_C = 50mA$ for MJE800/1, MJE700/1 for MJE802/3, MJE702/3	60 80			V V
$V_{CE(sat)}^*$	Collector-emitter Saturation Voltage	$I_C = 4A$ $I_B = 40mA$ for MJE800/2, MJE700/2 $I_C = 1.5A$ $I_B = 30mA$ for MJE801/3, MJE701/3 $I_C = 2A$ $I_B = 40mA$			3 2.5 2.8	V V V
V_{BE}^*	Base-emitter Voltage	$I_C = 4A$ $V_{CE} = 3V$ for MJE800/1, MJE700/1 $I_C = 1.5A$ $V_{CE} = 3V$ for MJE801/3, MJE701/3 $I_C = 2A$ $V_{CE} = 3V$			3 2.5 2.5	V V V
h_{FE}^*	DC Current Gain	$I_C = 4A$ $V_{CE} = 3V$ for MJE800/2, MJE700/2 $I_C = 1.5A$ $V_{CE} = 3V$ for MJE801/3, MJE701/3 $I_C = 2A$ $V_{CE} = 3V$	100 750 750			
h_{fe}	Small Signal Current Gain	$I_C = 1.5A$ $V_{CE} = 3V$ $f = 1MHz$	1			

* Pulsed : pulse duration = 300 μs , duty cycle = 1.5%.

Safe Operating Areas.

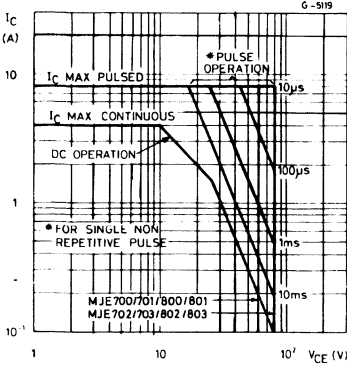

DCCurrent Gain.

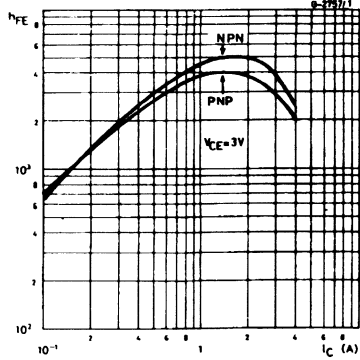

DC Transconductance.

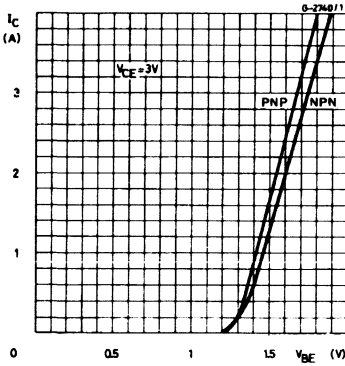

Collector-emitter Saturation Voltage.

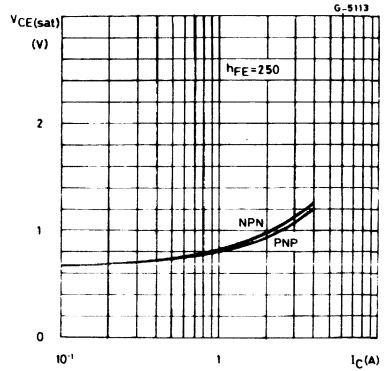

Small Signal Current Gain.

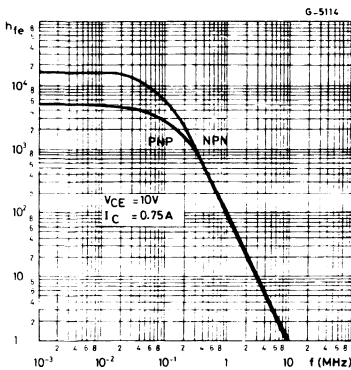

Collector-emitter Saturation Voltage (NPN).

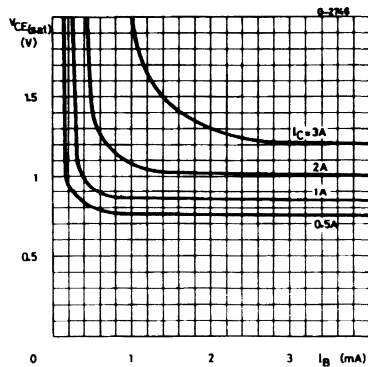

Saturated Switching Characteristics (NPN).

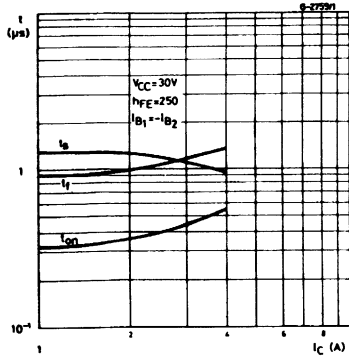

Collector-emitter Saturation Voltage (PNP).

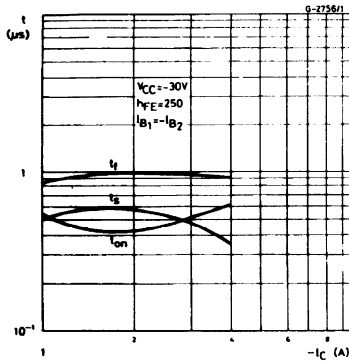

Collector-emitter Saturation Voltage (PNP).

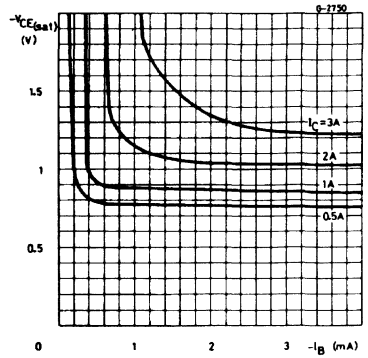



MEDIUM POWER AND SWITCHING APPLICATIONS

DESCRIPTION

The MJE3055T is a silicon epitaxial-base NPN transistor in Jedec TO-220 package. It is intended for power switching circuits and general-purpose amplifiers. The complementary PNP type is MJE2955T.

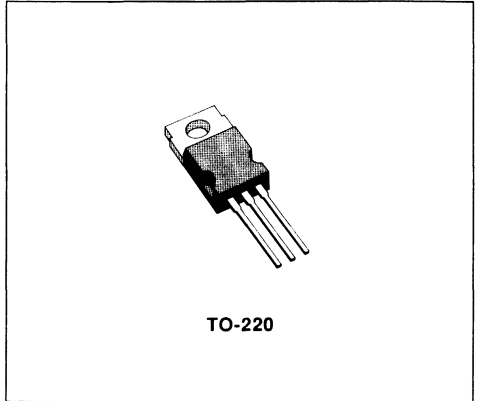

INTERNAL SCHEMATIC DIAGRAMS

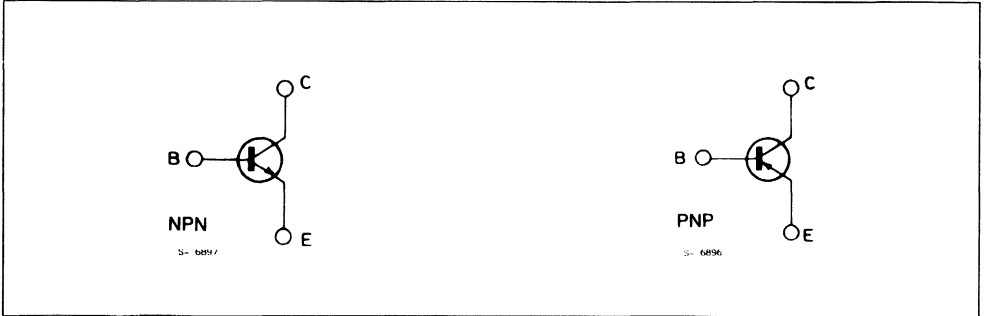

ABSOLUTE MAXIMUM RATINGS

Symbol	Parameter	Value	Unit
V_{CE0}	Collector-emitter Voltage ($I_B = 0$)	60	V
V_{CB0}	Collector-base Voltage ($I_E = 0$)	70	V
V_{EB0}	Emitter-base Voltage ($I_C = 0$)	5	V
I_C	Collector Current	10	A
I_B	Base Current	6	A
P_{tot}	Total Power Dissipation at $T_{case} \leq 25^\circ C$	75	W
T_{stg}	Storage Temperature	- 55 to 150	$^\circ C$
T_J	Junction Temperature	150	$^\circ C$

For PNP types voltage and current values are negative.

THERMAL DATA

$R_{th\ j-case}$	Thermal Resistance Junction-case	Max	1.66	°C/W
------------------	----------------------------------	-----	------	------

ELECTRICAL CHARACTERISTICS ($T_{case} = 25^{\circ}C$ unless otherwise specified)

Symbol	Parameter	Test Conditions	Min.	Typ.	Max.	Unit
I_{CEO}	Collector Cutoff Current ($I_B = 0$)	$V_{CE} = 30V$			700	μA
I_{CEX}	Collector Cutoff Current ($V_{EB} = 1.5V$)	$V_{CE} = 70V$ $T_{case} = 150^{\circ}C$			1 5	mA mA
I_{CBO}	Collector Cutoff Current ($I_E = 0$)	$V_{CBO} = 70V$ $T_{case} = 150^{\circ}C$			1 10	mA mA
I_{EBO}	Emitter Cutoff Current ($I_C = 0$)	$V_{EBO} = 5V$			5	mA
$V_{CEO(sus)}^*$	Collector-Emitter Sustaining Voltage	$I_C = 200mA$	60			V
$V_{CE(sat)}^*$	Collector-emitter Sustaining Voltage	$I_C = 4A$ $I_B = 0.4A$ $I_C = 10A$ $I_B = 3.3A$			1.1 8	V V
$V_{BE(on)}^*$	Base-emitter on Voltage	$I_C = 4A$ $V_{CE} = 4V$			1.8	V
h_{FE}^*	DC Current Gain	$I_C = 4A$ $V_{CE} = 4V$ $I_C = 10A$ $V_{CE} = 4V$	20 5		70	
f_T	Transition Frequency	$I_C = 500mA$ $f = 500KHz$ $V_{CE} = 10V$	2			MHz

* Pulsed : pulse duration = 300 μs , duty cycle $\leq 2\%$.
For PNP type voltage and current values are negative.

Safe Operating Areas.

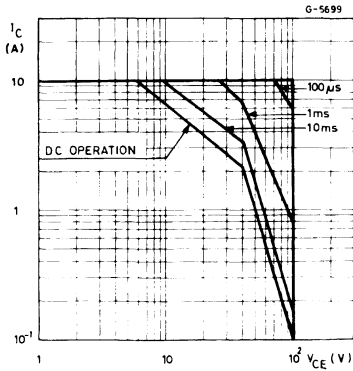



HIGH VOLTAGE TRANSISTOR

DESCRIPTION

The MJE3439, MJE3440, SGS3439 and SGS3440 are NPN silicon epitaxial planar transistors respectively in TO-126 and SOT-82 plastic package. They are designed for use in consumer and industrial line-operated applications.

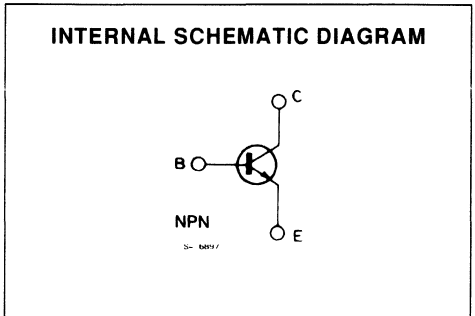
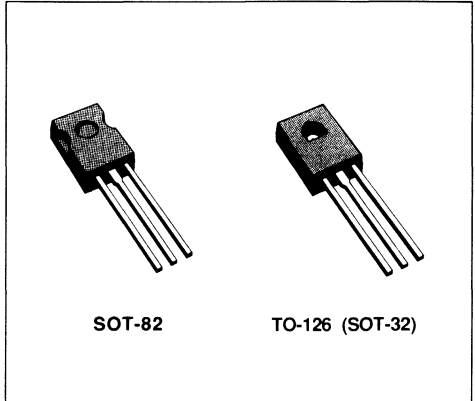

ABSOLUTE MAXIMUM RATINGS

Symbol	Parameter	Value		Unit
		MJE3439 SGS3439	MJE3440 SGS3440	
V_{CBO}	Collector-base Voltage ($I_E = 0$)	450	350	V
V_{CEO}	Collector-emitter Voltage ($I_B = 0$)	350	250	V
V_{EBO}	Emitter-base Voltage ($I_C = 0$)	5		V
I_C	Collector Current	0.3		A
I_B	Base Current	0.15		A
P_{tot}	Total Power Dissipation at $T_{case} \leq 25^\circ\text{C}$	15		W
T_{stg}	Storage Temperature	- 65 to 150		$^\circ\text{C}$
T_j	Junction Temperature	150		$^\circ\text{C}$

THERMAL DATA

$R_{th(j-case)}$	Thermal Resistance Junction-case	Max	8.33	°C/W
------------------	----------------------------------	-----	------	------

ELECTRICAL CHARACTERISTICS ($T_{case} = 25^{\circ}C$ unless otherwise specified)

Symbol	Parameter	Test Conditions	Min.	Typ.	Max.	Unit
I_{CBO}	Collector Cutoff Current ($I_E = 0$)	for MJE3439, SGS3439 $V_{CB} = 350V$ for MJE3440, SGS3440 $V_{CB} = 250V$			20	μA
I_{CEV}	Collector Cutoff Current ($V_{BE} = -1.5V$)	for MJE3439, SGS3439 $V_{CE} = 450V$ for MJE3440, SGS3440 $V_{CE} = 300V$			500	μA
I_{CEO}	Collector Cutoff Current ($I_B = 0$)	for MJE3439, SGS3439 $V_{CE} = 300V$ for MJE3440, SGS3440 $V_{CE} = 200V$			20	μA
I_{EBO}	Emitter Cutoff Current ($I_C = 0$)	$V_{EB} = 5V$			20	μA
$V_{CE(sat)^*}$	Collector-emitter Saturation Voltage	$I_C = 50mA$ $I_B = 4mA$			0.5	V
$V_{BE(sat)^*}$	Base-emitter Saturation Voltage	$I_C = 50mA$ $I_B = 4mA$			0.3	V
V_{BE}^*	Base-emitter Voltage	$I_C = 50mA$ $V_{CE} = 10V$			0.8	V
h_{FE}^*	DC Current Gain	$I_C = 2mA$ $V_{CE} = 10V$ $I_C = 20mA$ $V_{CE} = 10V$	30		200	
h_{fe}	Small Signal Current Gain	$I_C = 5mA$ $V_{CE} = 10V$ $f = 1KHz$	25			
f_T	Transition Frequency	$I_C = 10mA$ $V_{CE} = 10V$ $f = 5MHz$	15			MHz
C_{CBO}^*	Collector-base Capacitance	$V_{CB} = 10V$ $I_E = 0$ $f = 1MHz$			10	pF

* Pulsed : pulse duration = 300 μs , duty cycle $\leq 1.5\%$.

Safe Operating Areas.

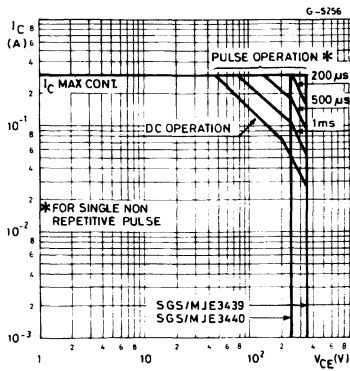

DC Current Gain.

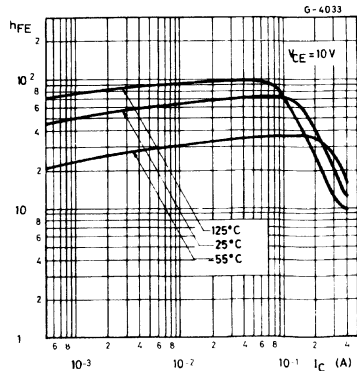

Collector-emitter Saturation Voltage.

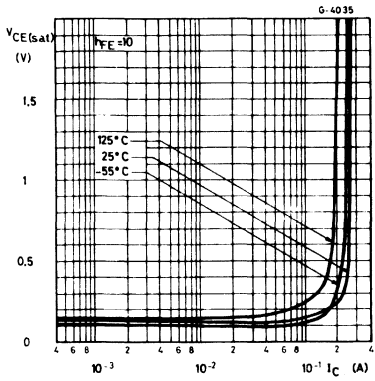

Base-emitter Voltage.

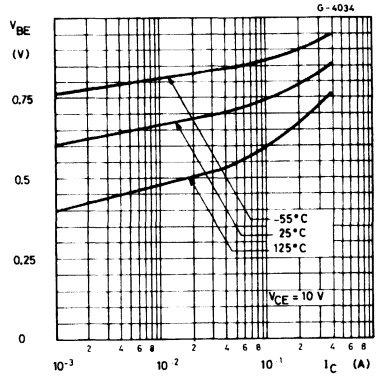

Transition Frequency.

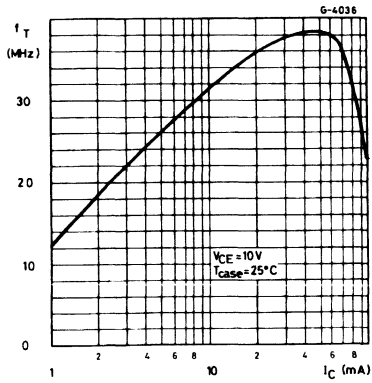

HIGH VOLTAGE POWER SWITCH

DESCRIPTION

The MJE13004/13005 are silicon multiepitaxial mesa NPN transistors in Jedec TO-220 plastic package particularly intended for switch-mode applications.

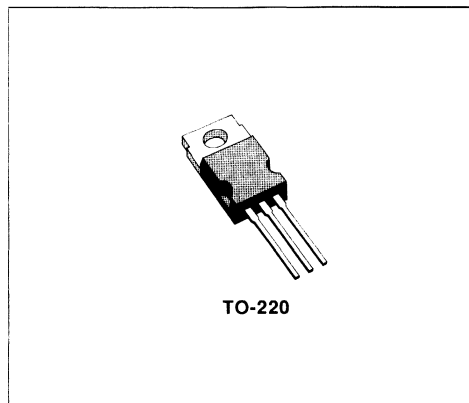

INTERNAL SCHEMATIC DIAGRAM

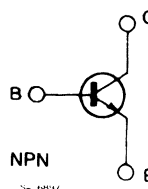

ABSOLUTE MAXIMUM RATINGS

Symbol	Parameter	Value		Unit
		MJE13004	MJE13005	
V_{CEV}	Collector-emitter Voltage	600	700	V
V_{CEO}	Collector-emitter Voltage ($I_B = 0$)	300	400	V
V_{EBO}	Emitter-base ($I_C = 0$)	9		V
I_C	Collector Current	4		A
I_{CM}	Collector Peak Current	8		A
I_B	Base Current	2		A
I_{BM}	Base Peak Current	4		A
P_{tot}	Total Power Dissipation at $T_{case} \leq 25^\circ\text{C}$	75		W
T_{stg}	Storage Temperature	- 65 to 150		$^\circ\text{C}$
T_J	Junction Temperature	150		$^\circ\text{C}$

THERMAL DATA

$R_{th\ j-case}$	Thermal Resistance Junction-case	max	1.67	°C/W
------------------	----------------------------------	-----	------	------

ELECTRICAL CHARACTERISTICS($T_{case} = 25^{\circ}C$ unless otherwise specified)

Symbol	Parameter	Test Conditions	Min.	Typ.	Max.	Unit
I_{CEV}	Collector Cutoff Current ($V_{BE} = -1.5V$)	for MJE13004 $V_{CE} = 600V$ $V_{CE} = 600V$ $T_{case} = 100^{\circ}C$ for MJE13005 $V_{CE} = 700V$ $V_{CE} = 700V$ $T_{case} = 100^{\circ}C$			1 5	mA mA
I_{EBO}	Emitter Cutoff Current ($I_C = 0$)	$V_{EB} = 9V$			1	mA
$V_{CEO(sus)}^*$	Collector-emitter Sustaining Voltage ($I_B = 0$)	$I_C = 10mA$ for MJE13004 for MJE13005	300 400			V
$V_{CE(sat)}^*$	Collector-emitter Saturation Voltage	$I_C = 1A$ $I_B = 0.2A$ $I_C = 2A$ $I_B = 0.5A$ $I_C = 4A$ $I_B = 1A$			0.5 0.6 1	V V V
$V_{BE(sat)}^*$	Base-emitter Saturation Voltage	$I_C = 1A$ $I_B = 0.2A$ $I_C = 2A$ $I_B = 0.5A$			1.2 1.6	V V
h_{FE}	DC Current Gain	$I_C = 1A$ $V_{CE} = 5V$ $I_C = 2A$ $V_{CE} = 5V$	10 8	30	60 40	
t_{on} t_s t_f	Turn-on Time Storage Time Fall Time	$I_C = 2A$ $I_{B1} = -I_{B2} = 0.4A$ $V_{CC} = 250V$			0.8 4 0.9	μs μs μs

* Pulsed : pulse duration = 300 μs , duty cycle = 1.5%.

Safe Operating Areas.

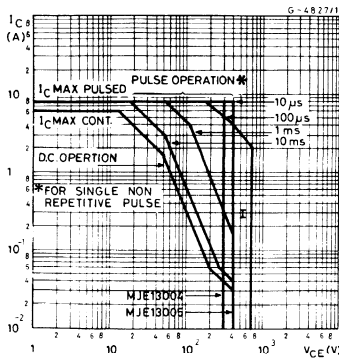

I - Area of permissible operation during turn-on provided $R_{BE} \leq 100\Omega$ and $t_p \leq 0.25\mu s$.

DC Current Gain.

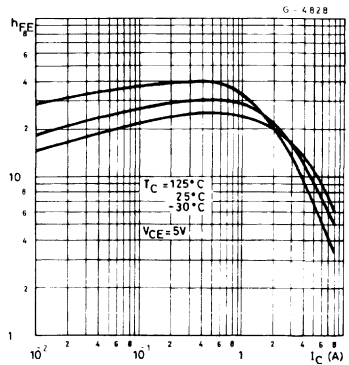

Collector-emitter Saturation Voltage.

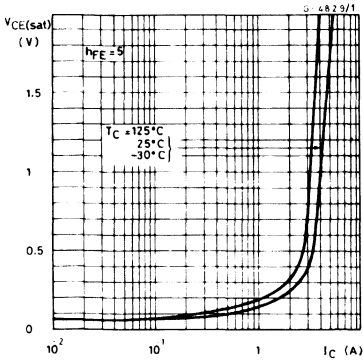

Collector-emitter Saturation Voltage.

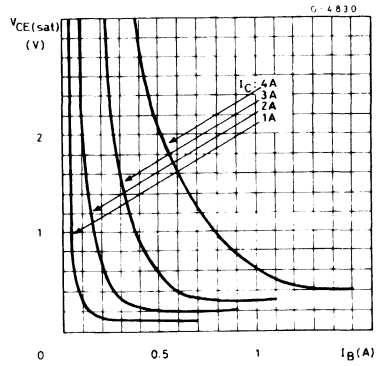

Base-emitter Saturation Voltage.

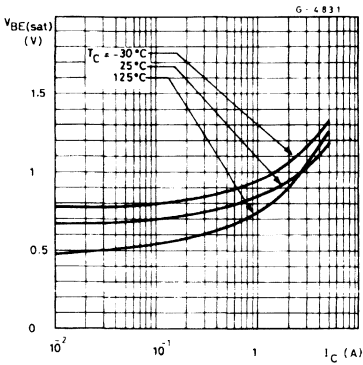

Saturated Switching Characteristics.

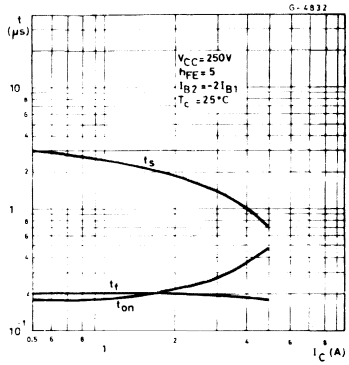

Saturated Switching Characteristics.

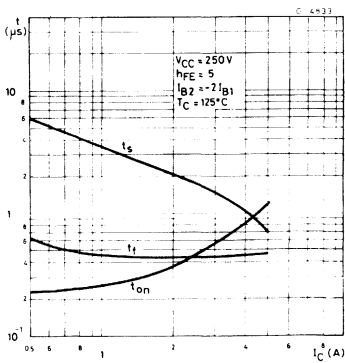

Saturated Switching Characteristics.

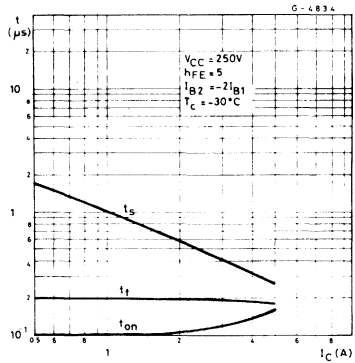

Clamped Reverse bias Safe Operating Areas.

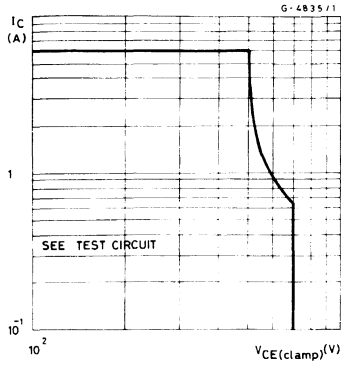

Clamped $E_{S/b}$ Test Circuit.

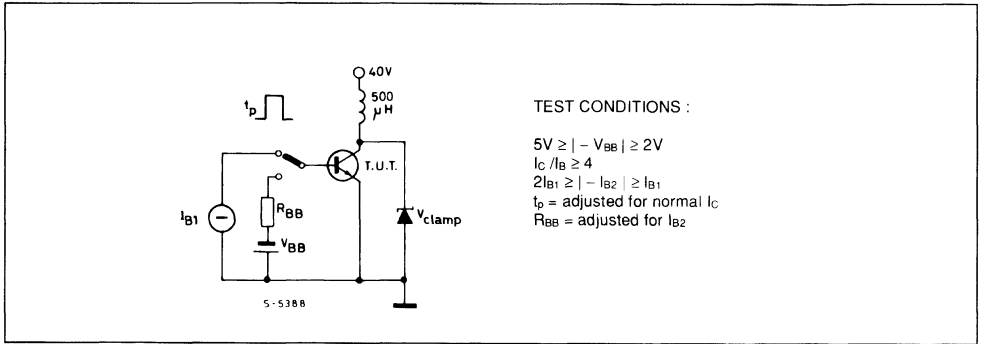

MOTOR CONTROL, SWITCH REGULATORS
DESCRIPTION

The MJE13006, MJE13007 and MJE13007A are silicon multiepitaxial mesa NPN transistors. They are mounted in Jedec TO-220 plastic package, intended for use in motor controls, switching regulator's etc.

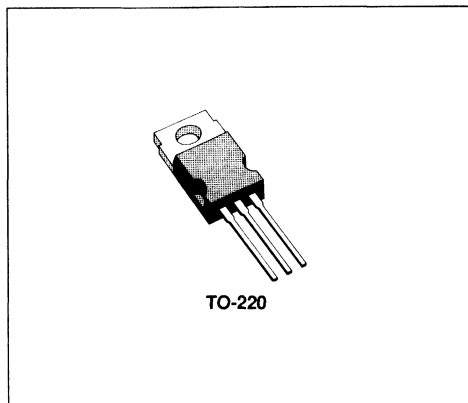
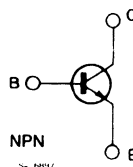
INTERNAL SCHEMATIC DIAGRAM

ABSOLUTE MAXIMUM RATINGS

Symbol	Parameter	Value			Unit
		MJE13006	MJE13007	MJE13007A	
V_{CEO}	Collector-emitter Voltage ($V_B = 0$)	300	400	400	V
V_{CEV}	Collector-emitter Voltage	600	700	850	V
V_{EBO}	Emitter-base Voltage ($I_C = 0$)	9			V
I_C	Collector Current	8			A
I_{CM}	Collector Peak Current	16			A
I_B	Base Current	4			A
I_{BM}	Base Peak Current	8			A
I_E	Emitter Current	12			A
I_{EM}	Emitter Peak Current	24			A
P_{tot}	Total Power Dissipation at $T_{case} \leq 25^\circ\text{C}$	80			W
T_{stg}	Storage Temperature	- 65 to 150			$^\circ\text{C}$
T_j	Junction Temperature	150			$^\circ\text{C}$

THERMAL DATA

$R_{th\ j-case}$	Thermal Resistance Junction-case	Max	1.56	°C/W
------------------	----------------------------------	-----	------	------

ELECTRICAL CHARACTERISTICS ($T_{case} = 25^{\circ}C$ unless otherwise specified)

Symbol	Parameter	Test Conditions	Min.	Typ.	Max.	Unit
I_{EBO}	Emitter Cutoff Current ($I_C = 0$)	$V_{EB} = 9\ V$			1	mA
I_{CEV}	Collector Cutoff Current ($V_{BE} = 1.5V$)	$V_{CEV} = \text{rated value}$ $V_{CEV} = \text{rated value}$ $T_{case} = 100^{\circ}C$			1 5	mA mA
$V_{CEO(sus)}^*$	Collector-Emitter Sustaining Voltage ($I_B = 0$)	$I_C = 10\ mA$ for MJE13006 for MJE13007/13007A	300 400			V V
$V_{CE(sat)}^*$	Collector-emitter Saturation Voltage	$I_C = 2A$ $I_B = 0.4A$ $I_C = 5A$ $I_B = 1A$ $I_C = 8A$ $I_B = 2A$ $I_C = 5A$ $I_B = 1A$ $T_{case} = 100^{\circ}C$			1 1.5 3 2	V V V V
$V_{BE(sat)}^*$	Base-emitter Saturation Voltage	$I_C = 2A$ $I_B = 0.4A$ $I_C = 5A$ $I_B = 1A$ $I_C = 5A$ $I_B = 1A$ $T_{case} = 100^{\circ}C$			1.2 1.6 1.5	V V V
h_{FE}^*	DC Current Gain	$I_C = 2A$ $V_{CE} = 5V$ $I_C = 5A$ $V_{CE} = 5V$	8 6		40 30	
f_T	Transition Frequency	$I_C = 500mA$ $V_{CE} = 10V$ $f = 1MHz$	4			MHz
C_{CBO}	Output Capacitance	$V_{CB} = 10V$ $I_E = 0$ $f = 0.1MHz$		110		pF

RESISTIVE SWITCHING TIMES (fig. 2)

Symbol	Parameter	Test Conditions	Min.	Typ.	Max.	Unit
t_{on}	Turn-on Time	$V_{CC} = 125V$ $I_C = 5A$ $I_{B1} = -$ $I_{B2} = 1A$ $t_p = 25\mu s$ Duty Cycle < 1%			0.7	μs
t_s	Storage Time				3	μs
t_f	Fall Time				0.7	μs

INDUCTIVE SWITCHING TIMES (fig. 1)

Symbol	Parameter	Test Conditions	Min.	Typ.	Max.	Unit
t_f	Fall Time	$V_{CC} = 125V$ $I_C = 5A$ $I_{B1} = 1A$ $t_p = 25\mu s$ Duty Cycle < 1% $T_{case} = 100^{\circ}C$ $V_{CC} = 125V$ $I_C = 5A$ $I_{B1} = 1A$ $t_p = 25\mu s$ Duty Cycle \leq 1%			0.3 0.6	μs μs

* Pulsed : pulse duration \leq 300 μs , duty cycle \leq 1.5 %.

Safe Operating Areas.

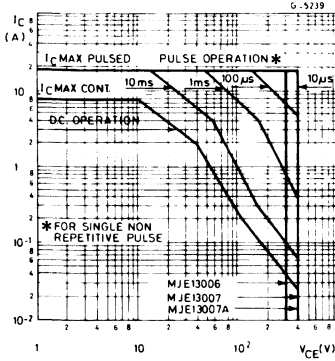

Clamped Reverse Bias operating Areas.

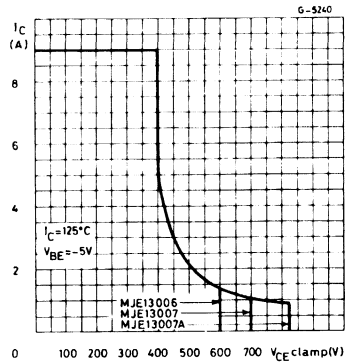

Forward Biased Accidental Overload Area (see fig. 3).

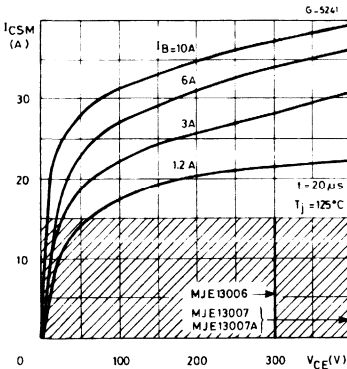

Collector Saturation Voltage.

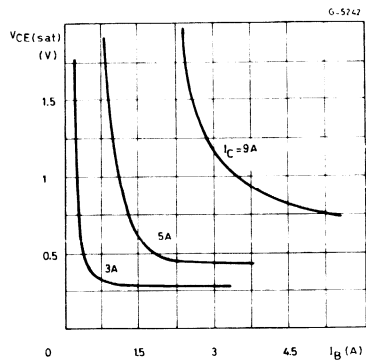

Saturation Voltages.

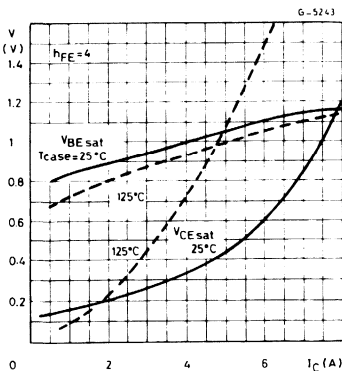

Collector Current Spread vs. Emitter Voltage.

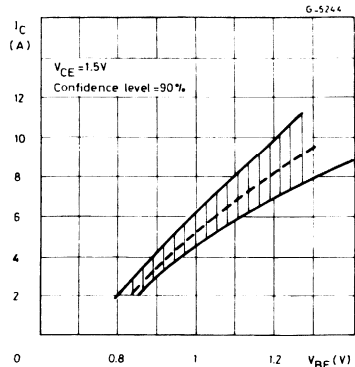

Switching Times Resistive Load (see fig. 2).

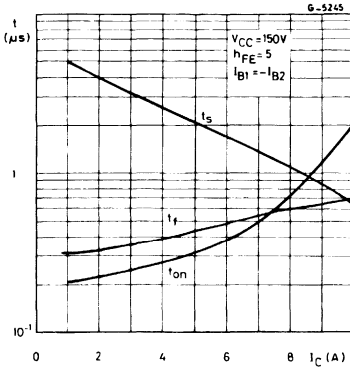

Switching Times Percentage Variation vs. Case Temperature.

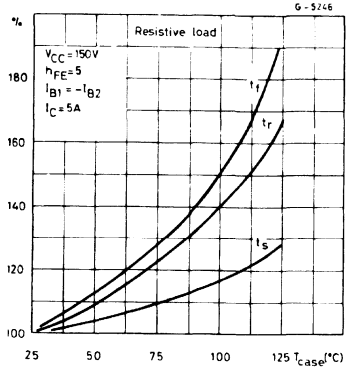

Switching Times Inductive Load (see fig. 1).

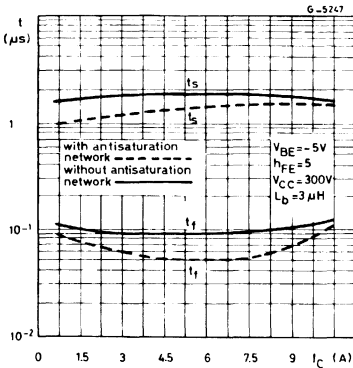

Switching Times Inductive Load vs. Case Temperature.

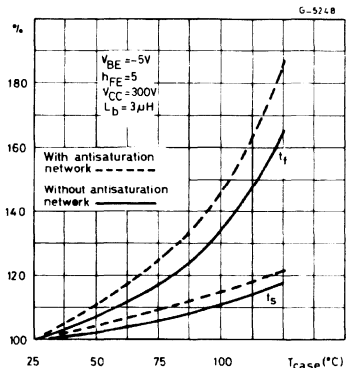

Fall Times vs. Lb (see fig. 1).

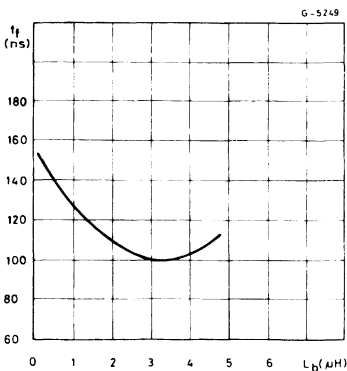

Dynamic Collector-emitter Saturation Voltage (see fig. 4).

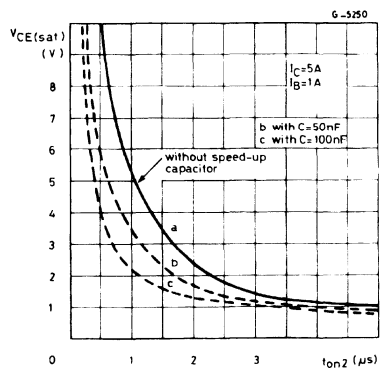

DC Current Gain.

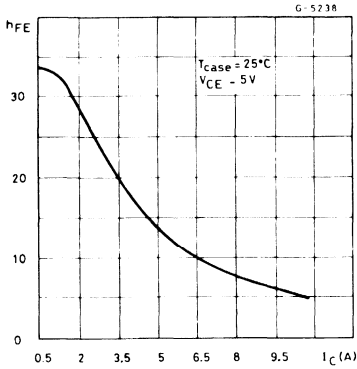

Figure 1 : Switching Times Test Circuit on Inductive Load, with and without Antisaturation Network.

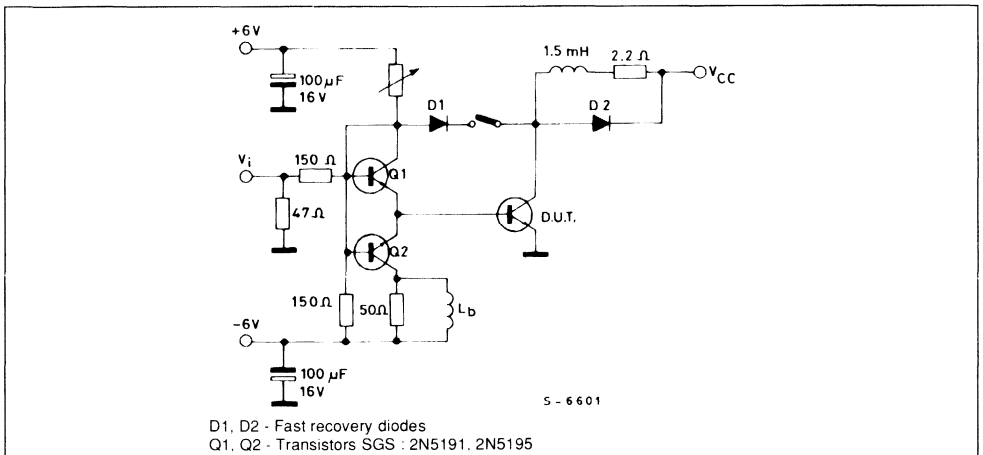

Figure 2 : Switching Times Test Circuit on Resistive Load.

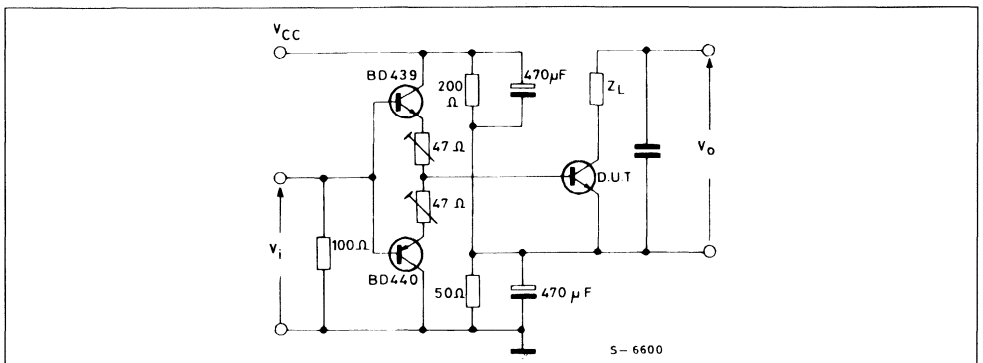

Figure 3 : Forward Biased Accidental Overload Area Test Circuit.

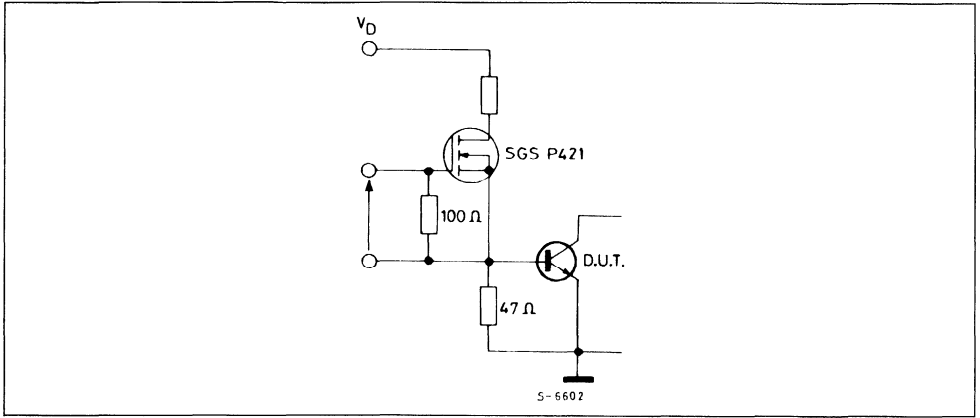

Figure 4 : $V_{CE(sat)}$ Dyn. Test Circuit.

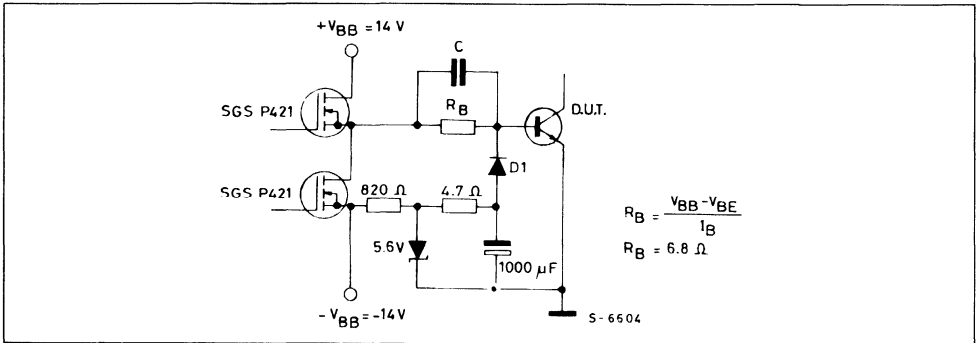

Figure 5 : Equivalent Input Schematic Circuit at Turn-on.

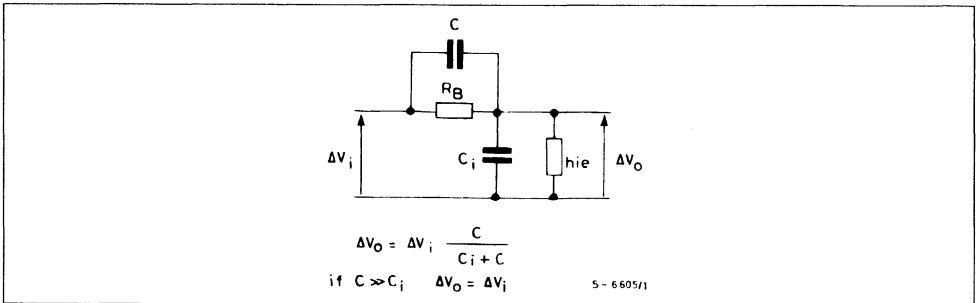
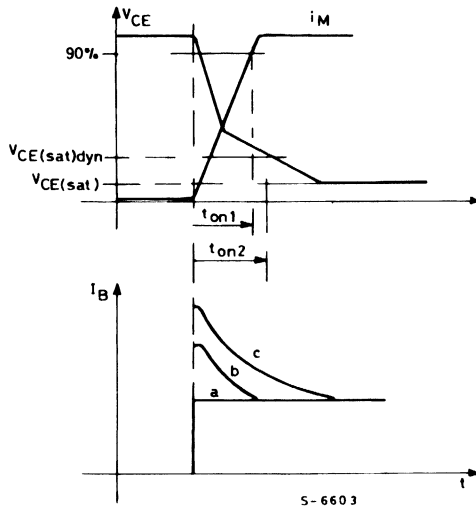

Figure 6 : Remarks to $V_{CE(sat)}$ Dyn. Test Circuit (fig. 4).



S-6603

The speed-up capacitor decreases the $V_{CE(sat)}$ dyn, as shown in diagram (figure 6).
 The 50 nF capacitor modifies the shape of base current with a overshoot.

HIGH VOLTAGE, HIGH SPEED, POWER SWITCHING

DESCRIPTION

The MJE13008 and MJE13009 are silicon multi-epitaxial mesa NPN transistors. They are mounted in Jedec TO-220 plastic package, intended for use in motor controls, switching regulators deflection circuits, etc.

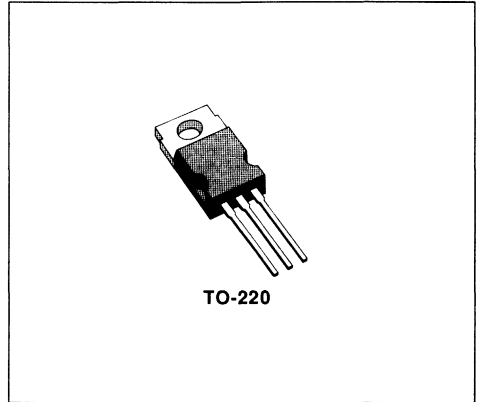

INTERNAL SCHEMATIC DIAGRAM

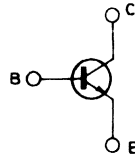

ABSOLUTE MAXIMUM RATINGS

Symbol	Parameter	Value		Unit
		MJE13008	MJE13009	
V_{CEO}	Collector-emitter Voltage ($I_B = 0$)	300	400	V
V_{CEV}	Collector-emitter Voltage	600	700	V
V_{EBO}	Emitter-base Voltage ($I_C = 0$)	9		V
I_C	Collector Current	12		A
I_{CM}	Collector Peak Current ($t_p \leq 10\text{ms}$)	24		A
I_B	Base Current	6		A
I_{BM}	Base Peak Current ($t_p \leq 10\text{ms}$)	12		A
I_E	Emitter Current	18		A
I_{EM}	Emitter Peak Current	36		A
P_{tot}	Total Power Dissipation at $T_{case} \leq 25^\circ\text{C}$	100		W
T_{stg}	Storage Temperature	- 65 to 150		$^\circ\text{C}$
T_j	Junction Temperature	150		$^\circ\text{C}$

THERMAL DATA

R _{th j-case}	Thermal Resistance Junction-case	Max	1.25	°C/W
------------------------	----------------------------------	-----	------	------

ELECTRICAL CHARACTERISTICS (T_{case} = 25°C unless otherwise specified)

Symbol	Parameter	Test Conditions	Min.	Typ.	Max.	Unit
I _{EB0}	Emitter Cutoff Current (I _C = 0)	V _{EB} = 9 V			1	mA
I _{CEV}	Collector Cutoff Current	V _{CEV} = rated value V _{BE(off)} = 1.5V V _{CEV} = rated value V _{EB(off)} = 1.5V T _{case} = 100°C			1 5	mA mA
V _{CEO(sus)} *	Collector-Emitter Sustaining Voltage	I _C = 10 mA I _E = 0 for MJE13008 for MJE13009	300 400			V V
V _{CE(sat)} *	Collector-emitter Saturation Voltage	I _C = 5A I _B = 1A I _C = 8A I _B = 1.6A I _C = 12A I _B = 3A I _C = 8A I _B = 1.6A T _{case} = 100°C			1 1.5 3 2	V V V V
V _{BE(sat)} *	Base-emitter Saturation Voltage	I _C = 5A I _B = 1A I _C = 8A I _B = 1.6A I _C = 8A I _B = 1.6A T _{case} = 100°C			1.2 1.6 1.5	V V V
h _{FE} *	DC Current Gain	I _C = 5A V _{CE} = 5V I _C = 8A V _{CE} = 5V	8 6		40 30	
f _T	Transition Frequency	I _C = 500mA V _{CE} = 10V	4			MHz
C _{OB}	Output Capacitance	V _{CB} = 10V I _E = 0 f = 0.1MHz		180		pF
t _{on}	Turn-on Time	RESISTIVE LOAD V _{CC} = 125V I _C = 8A			1.1	μs
t _s	Storage Time	I _{B1} = I _{B2} = 1.6A t _p = 25μs			3	μs
t _f	Fall Time	Duty Cycle ≤ 1%			0.7	μs

* Pulsed : pulse duration = 300μs, duty cycle ≤ 2%.

Safe Operating Areas.

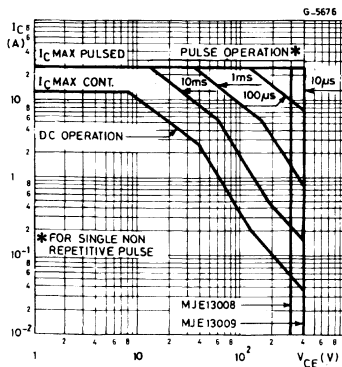

DC Current Gain.

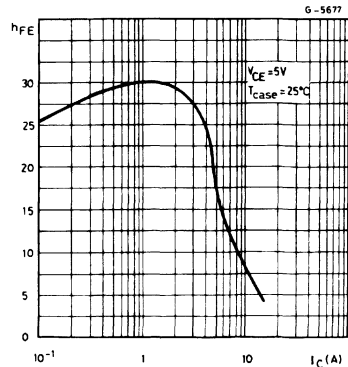

Collector-emitter Saturation Voltage.

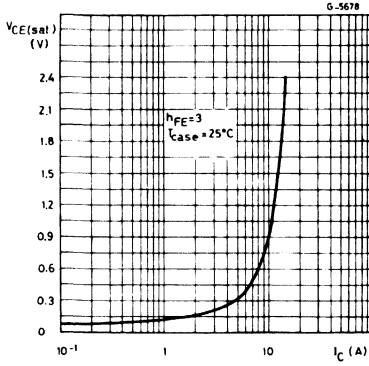

Collector-emitter Saturation Voltage.

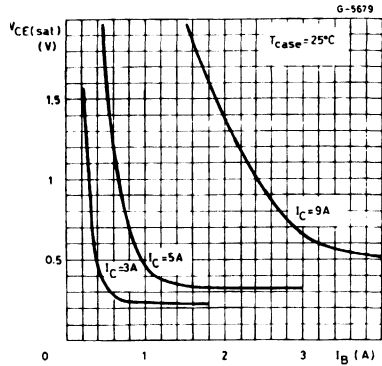

Base-emitter Saturation Voltage.

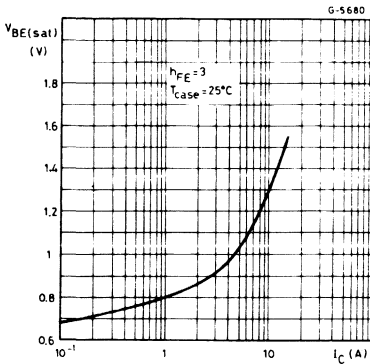

Collector Current Spread vs. Base-emitter Voltage.

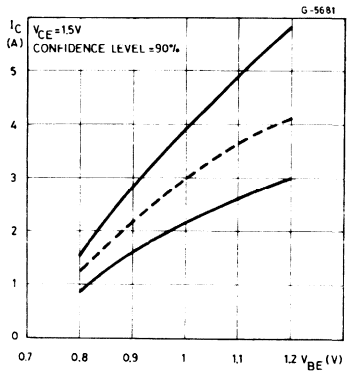

Switching Times Resistive Load (see fig. 2).

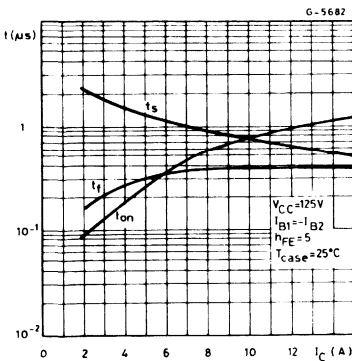

Switching Times Inductive Load (see fig. 1).

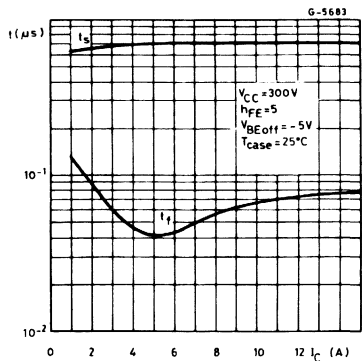

Switching Times vs. T_{case} Inductive Load.

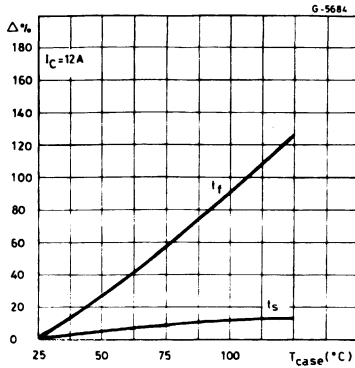

Dynamic Collector-emitter Saturation Voltage (see fig. 2).

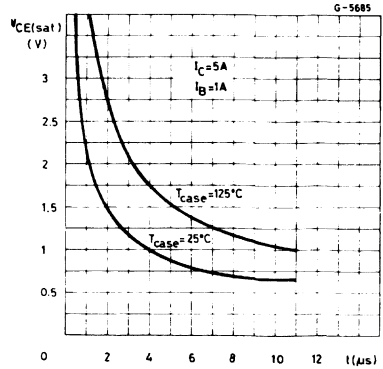

Clamped Reverse Bias Safe Operating Areas..

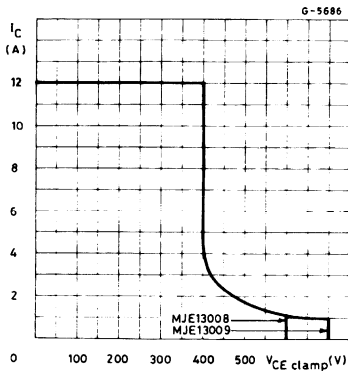

Figure 1 : Switching Times Test Circuit on Inductive Load.

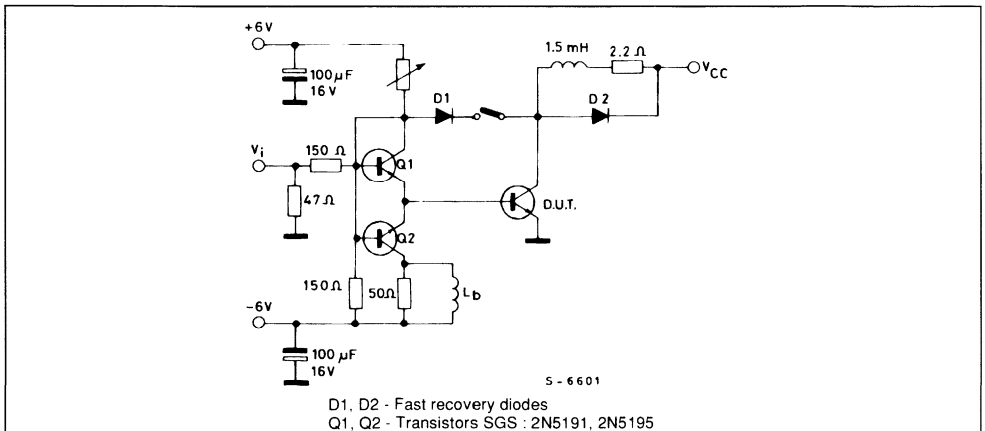
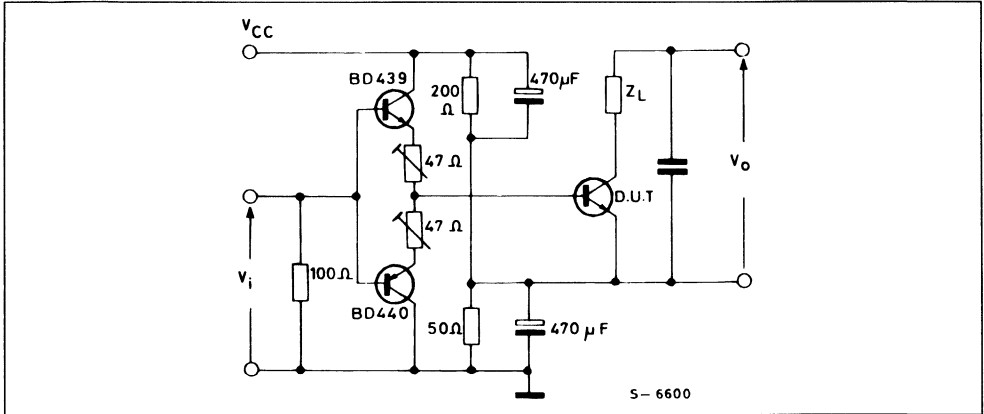

Figure 2 : Switching Times Test Circuit on Resistive Load and $V_{CE(sat)}$ Dyn. Test Circuit.



HIGH VOLTAGE SWITCHING APPLICATIONS

DESCRIPTION

The SGS13002, SGS13003 (SOT-82 plastic package) and the SGS13002T, SGS13003T (TO-220 plastic package) are silicon multiepitaxial-mesa NPN transistors, intended for high voltage applications. They are pin to pin replacement to MJE13002 & 13003 (TO-126, with reserved pin out).

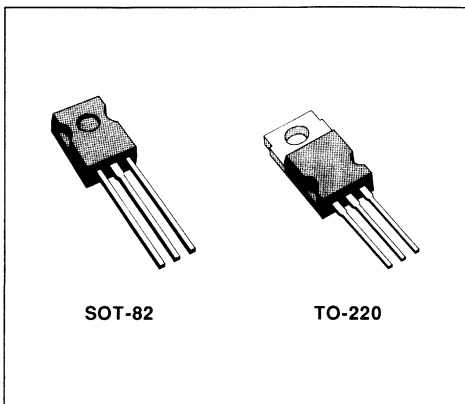

INTERNAL SCHEMATIC DIAGRAM

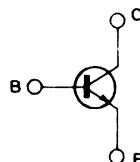

ABSOLUTE MAXIMUM RATINGS

Symbol	Parameter	Value		Unit
		SGS13002 SGS13002T	SGS13003 SGS13003T	
V_{CEV}	Collector-emitter Voltage ($V_{BE} = 1.5 \text{ V}$)	600	700	V
V_{CEO}	Collector-emitter Voltage ($I_B = 0$)	300	400	V
V_{EBO}	Emitter-base Voltage ($I_C = 0$)	9		V
I_C	Collector Current	1.5		A
I_{CM}	Collector Peak Current ($t_p < 5 \text{ ms}$)	3		A
I_B	Base Current	0.75		A
I_{BM}	Base Peak Current ($t_p < 5 \text{ ms}$)	1.5		A
P_{tot}	Total Power Dissipation at $T_{case} \leq 25 \text{ }^\circ\text{C}$ at $T_{amb} \leq 25 \text{ }^\circ\text{C}$	50	2	W
T_{stg}	Storage Temperature	- 65 to 150		$^\circ\text{C}$
T_J	Junction Temperature	150		$^\circ\text{C}$

THERMAL DATA

R _{th j-amb}	Thermal Resistance Junction-ambient	Max	62.5	°C/W
R _{th j-case}	Thermal Resistance Junction-case	Max	2.5	°C/W

ELECTRICAL CHARACTERISTICS (T_{case} = 25 °C unless otherwise specified)

Symbol	Parameter	Test Conditions	Min.	Typ.	Max.	Unit
I _{CEV}	Collector Cutoff Current (V _{BE} = - 1.5 V)	for SGS13002/ 13002T V _{CE} = 600 V V _{CE} = 600 V T _{case} = 100 °C for SGS13003/ 13003T V _{CE} = 700 V V _{CE} = 700 V T _{case} = 100 °C			1 5 1 5	mA mA mA mA
I _{EBO}	Emitter Cutoff Current (I _C = 0)	V _{EB} = 9 V			1	mA
V _{CEO(sus)} *	Collector-emitter Sustaining Voltage (I _B = 0)	I _C = 10 mA for SGS13002/ 13002T for SGS13003/ 13003T	300 400			V V
V _{CE(sat)} *	Collector-emitter Saturation Voltage	I _C = 0.5 A I _B = 0.1 A I _C = 1 A I _B = 0.25 A I _C = 1.5 A I _B = 0.5 A I _C = 1 A ; I _B = 0.25 A ; T _{case} = 100 °C			0.5 1 3 1	V V V V
V _{BE(sat)} *	Base-emitter Saturation Voltage	I _C = 0.5 A I _B = 0.1 A I _C = 1 A I _B = 0.25 A I _C = 1 A ; I _B = 0.25 A ; T _{case} = 100 °C			1 1.2 1.1	V V V
h _{FE} *	DC Current Gain	I _C = 0.5 A V _{CE} = 2 V I _C = 1 A V _{CE} = 2 V	8 5		40 25	
f _T	Transition Frequency	I _C = 100 mA ; V _{CE} = 10 V, f = 1 MHz	5	10		MHz
C _{CBO}	Collector-base Capacitance	V _{CB} = 10 V f = 0.1 MHz		30		pF

RESISTIVE SWITCHING TIMES

Symbol	Parameter	Test Conditions	Min.	Typ.	Max.	Unit.
t _r	Rise Time	V _{CC} = 125 V I _C = 1 A 2I _{B1} = - I _{B2} = 0.2 A		0.3	0.8	μs
t _s	Storage Time			1.1	2.5	μs
t _f	Fall Time			0.12	0.5	μs

INDUCTIVE SWITCHING TIMES

Symbol	Parameter	Test Conditions	Min.	Typ.	Max.	Unit.
t _{sv}	Storage Time	I _C = 1 A I _{B1} = 0.2 A V _{BE} = - 5 V L = 50 mH		0.8	2.5	μs
t _c	Crossover Time	V _{clamp} = 300 V		0.1	0.75	μs

* Pulsed : pulse duration = 300μs, duty cycle = 1.5 %.

Safe Operating Areas.

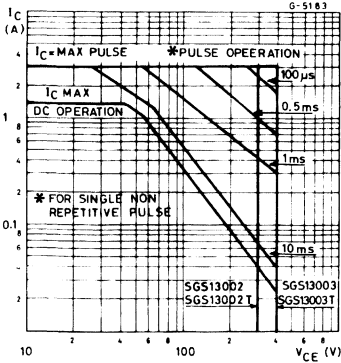

Collector-emitter Saturation Voltage.

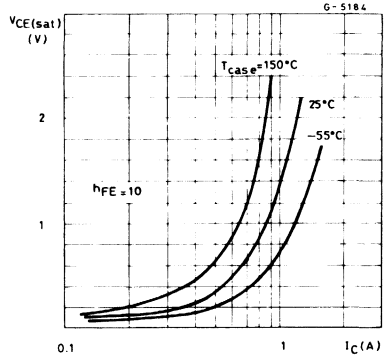

DC Current Gain.

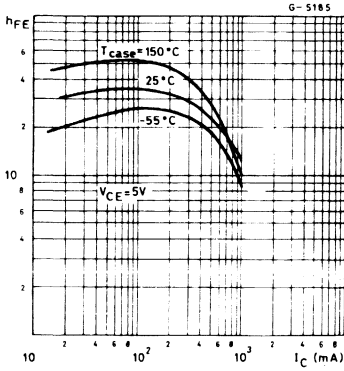

Collector-emitter Saturation Voltage.

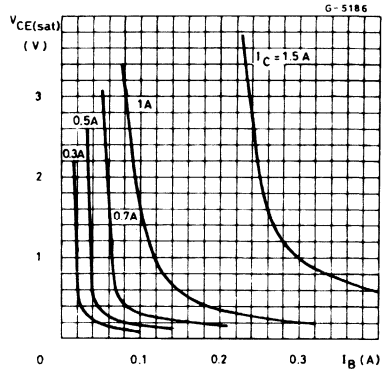

Base-emitter Saturation Voltage.

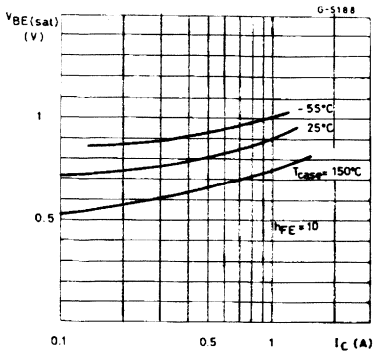

Base-emitter Saturation Voltage.

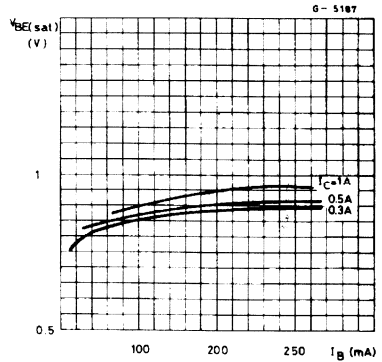

Resistive Load Switching Times.

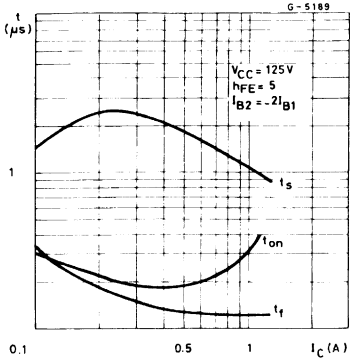

Switching Times Percentage Variation vs. case Temperature.

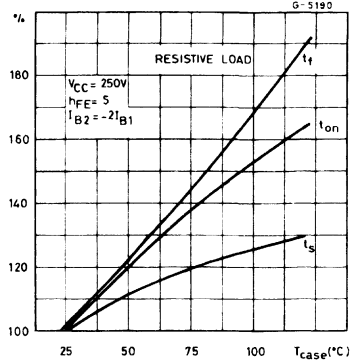

Clamped Reverse Bias Safe Operating Areas.

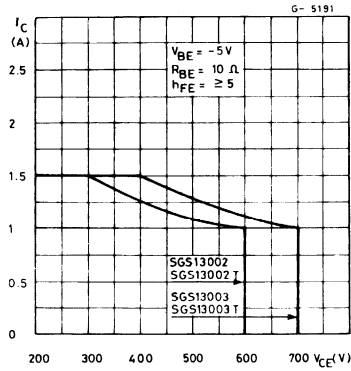

EPITAXIAL PLANAR NPN

ADVANCE DATA

- DAMPER DIODE

AUTOMOTIVE

- SWITCHING APPLICATION

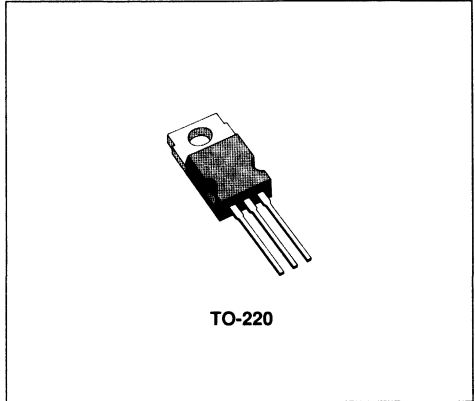

INTERNAL SCHEMATIC DIAGRAM

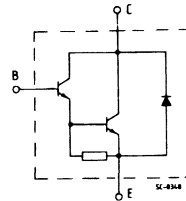

DESCRIPTION

The SGSD93E/93F/93G are silicon epitaxial planar NPN transistors in Darlington configuration mounted in Jedec TO-220 plastic package.

ABSOLUTE MAXIMUM RATINGS

Symbol	Parameter	Value			Unit
		SGSD93E	SGSD93F	SGSD93G	
V_{CRO}	Collector-base Voltage ($I_E = 0$)	160	180	200	V
V_{CES}	Collector-emitter Voltage ($V_{BE} = 0$)	140	160	180	V
V_{CEO}	Collector-emitter Voltage ($I_B = 0$)	140	160	180	V
V_{EBO}	Emitter-base Voltage ($I_C = 0$)	5			V
I_C	Collector Current	12			A
I_{CM}	Collector Peak Current	15			A
I_B	Base Current	0.2			A
P_{tot}	Total Dissipation at $T_c < 25^\circ\text{C}$	80			W
T_{stg}	Storage Temperature	- 65 to 150			$^\circ\text{C}$
T_j	Max. Operating Junction Temperature	150			$^\circ\text{C}$

THERMAL DATA

$R_{th\ J-case}$	Thermal Resistance Junction-case	Max	1.56	°C/W
------------------	----------------------------------	-----	------	------

ELECTRICAL CHARACTERISTICS ($T_{case} = 25\text{ °C}$ unless otherwise specified)

Symbol	Parameter	Test Conditions	Min.	Typ.	Max.	Unit
I_{CBO}	Collector Cutoff Current ($I_E = 0$)	$V_{CB} = 160\text{ V}$ for SGSD93E			50	μA
		$V_{CB} = 180\text{ V}$ for SGSD93F			50	μA
		$V_{CB} = 200\text{ V}$ for SGSD93G			50	μA
		$V_{CB} = 160\text{ V}$ for SGSD93E			2	mA
		$V_{CB} = 180\text{ V}$ for SGSD93F			2	mA
		$V_{CB} = 200\text{ V}$ for SGSD93G			2	mA
	$T_c = 150\text{ °C}$					
I_{CEO}	Collector Cutoff Current ($I_B = 0$)	$V_{CE} = 140\text{ V}$ for SGSD93E $V_{CE} = 160\text{ V}$ for SGSD93F $V_{CE} = 180\text{ V}$ for SGSD93G			0.5 0.5 0.5	mA mA mA
I_{EBO}	Emitter Cutoff Current ($I_C = 0$)	$V_{BE} = -5\text{ V}$			0.1	mA
$V_{CEO(sus)}^*$	Collector-emitter Sustaining Voltage	$I_C = 0.1\text{ A}$ for SGSD93E for SGSD93F for SGSD93G	140 160 180			V V V
$V_{CE(sat)}^*$	Collector-emitter Saturation Voltage	$I_C = 5\text{ A } I_B = 5\text{ mA}$			1.4	V
		$I_C = 10\text{ A } I_B = 20\text{ mA}$			2.0	V
		$I_C = 5\text{ A } I_B = 5\text{ mA } T_c = 150\text{ °C}$			1.4	V
		$I_C = 10\text{ A } I_B = 20\text{ mA } T_c = 150\text{ °C}$			2.2	V
		$I_C = 5\text{ A } I_B = 5\text{ mA } T_c = -40\text{ °C}$			1.6	V
$V_{BE(sat)}^*$	Base-emitter Saturation Voltage	$I_C = 5\text{ A } I_B = 5\text{ mA}$			2.0	V
		$I_C = 10\text{ A } I_B = 20\text{ mA}$			2.8	V
		$I_C = 5\text{ A } I_B = 5\text{ mA } T_c = 150\text{ °C}$			2.0	V
		$I_C = 5\text{ A } I_B = 5\text{ mA } T_c = -40\text{ °C}$			2.2	V
h_{FE}^*	DC Current Gain	$I_C = 150\text{ mA } V_{CE} = 1\text{ V}$	500		20000	
		$I_C = 3\text{ A } V_{CE} = 3\text{ V}$	1000			
		$I_C = 5\text{ A } V_{CE} = 3\text{ V}$	1000			
		$I_C = 10\text{ A } V_{CE} = 3\text{ V}$	750			
V_F^*	Diode Forward Voltage	$I_F = 5\text{ A}$			1.8	V
		$I_F = 10\text{ A}$			3.0	V
h_{fe}	Small Signal Current Gain	$I_C = 1\text{ A } V_{CE} = 5\text{ V } f = 5\text{ MHz}$		25		
RESISTIVE LOAD						
t_{on} t_s t_f	Turn-on Time Storage Time Fall Time	$I_C = 6\text{ A } I_{B1} = - I_{B2} = 24\text{ mA}$ $V_{CC} = 30\text{ V}$	500	700	1100	ns
			1.4	3.2	5.0	μs
			1.5	2.5	4.5	μs

* Pulsed : pulsed duration = 300 μs , duty cycle = 1.5 %.

Safe Operating Areas.

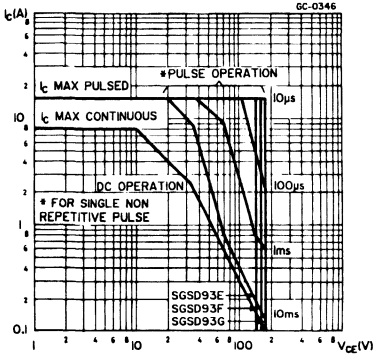

DC Current Gain.

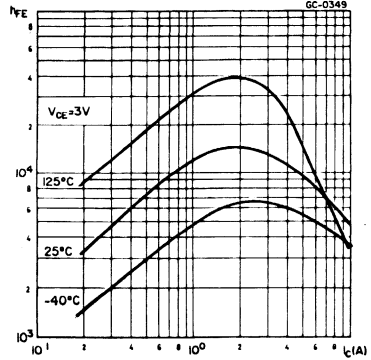

Collector-emitter Saturation Voltage.

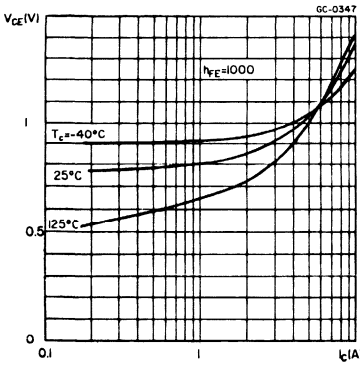

Base-emitter Saturation Voltage.

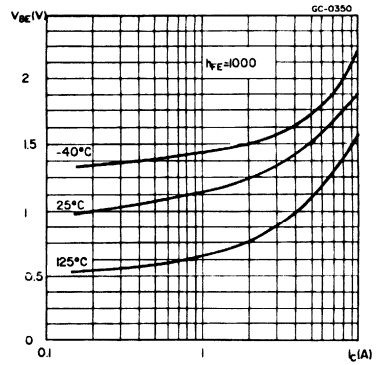

Emitter-collector Voltage.

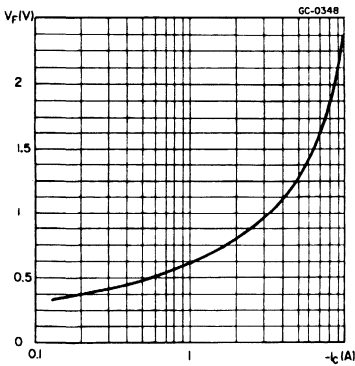

HIGH CURRENT DARLINGTONS

DESCRIPTION

The SGSD100 is a silicon epitaxial-base NPN transistors in TO-218 plastic package, intended for use in general purpose high current amplifier applications. The complementary PNP type is the SGSD200.

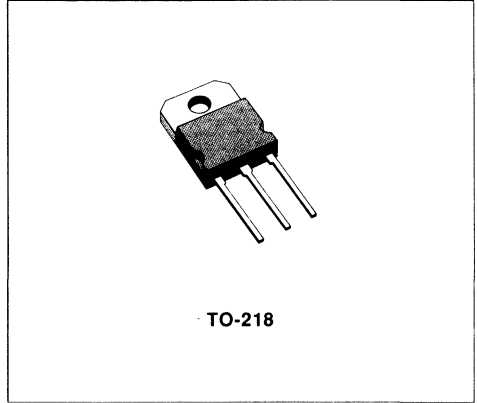

INTERNAL SCHEMATIC DIAGRAM

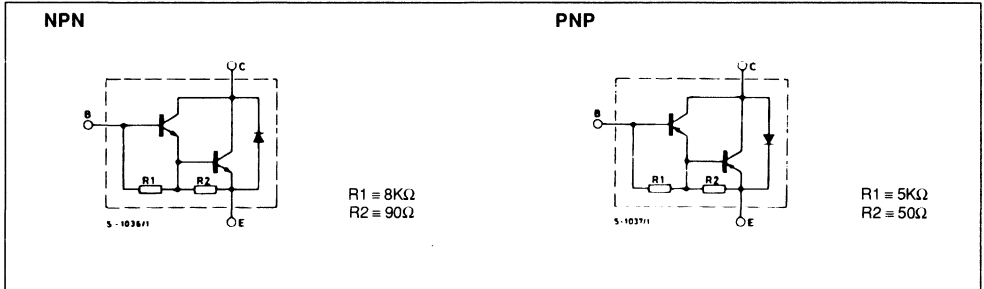

ABSOLUTE MAXIMUM RATINGS

Symbol	Parameter	Value	Unit
V_{CEO}	Collector-emitter Voltage	80	V
V_{CBO}	Collector-base Voltage	80	V
I_C	Collector Current	25	A
I_{CM}	Collector Peak Current	40	A
I_B	Base Current	6	A
I_{BM}	Base Peak Current	10	A
V_{EBO}	Emitter Base-voltage	10	V
P_{tot}	Total Power Dissipation	130	W
T_j	Junction Temperature	150	$^{\circ}C$

For PNP types voltage and current values are negative.

THERMAL DATA

$R_{th\ j-case}$	Thermal Resistance Junction-case	Max	0.96	°C/W
------------------	----------------------------------	-----	------	------

ELECTRICAL CHARACTERISTICS ($T_{case} = 25^{\circ}C$ unless otherwise specified)

Symbol	Parameter	Test Conditions	Min.	Typ.	Max.	Unit
$V_{CE0(isus)^*}$	Collector-emitter Sustaining Voltage ($I_B = 0$)	$I_C = 50mA$	80			V
I_{CEO}	Collector Cutoff Current ($I_B = 0$)	$V_{CE} = 60V$ $T_J = 100^{\circ}C$			500 1.5	μA mA
I_{CBO}	Collector Cutoff Current ($I_E = 0$)	$V_{CE} = 80V$ $T_J = 100^{\circ}C$			500 1.5	μA mA
I_{EBO}	Emitter Cutoff Current ($I_C = 0$)	$V_{EB} = 5V$			2	mA
I_{CEV}	Collector Cutoff Current ($V_{BE} = -0.3V$)	$V_{CE} = 80V$ $T_J = 100^{\circ}C$			100 2	μA mA
h_{FE}^*	DC Current Gain	$I_C = 5A$ $T_J = 100^{\circ}C$ $I_C = 10A$ $T_J = 100^{\circ}C$ $I_C = 20A$ $T_J = 100^{\circ}C$	$V_{CE} = 3V$ $V_{CE} = 3V$ $V_{CE} = 3V$	600 500 300	5K 8K 4K 8K 2K 2K	15K 10K 5K
$V_{CE(sat)^*}$	Collector-emitter Saturation Voltage	$I_C = 5A$ $T_J = 100^{\circ}C$ $I_C = 10A$ $T_J = 100^{\circ}C$ $I_C = 20A$ $T_J = 100^{\circ}C$	$I_B = 20mA$ $I_B = 40mA$ $I_B = 80mA$		0.95 0.8 1.2 1.3 2 2.3	1.2 1.75 3.5 V V
V_{BE}^*	Base-emitter Voltage	$I_C = 10A$ $T_J = 100^{\circ}C$	$V_{CE} = 3V$	1	1.8 1.6	3 V V
$V_{BE(sat)^*}$	Base-emitter Saturation Voltage	$I_C = 20A$ $T_J = 100^{\circ}C$	$I_B = 80mA$		2.6 2.5	3.3 V V
V_F	Diode Forward Voltage	$I_F = 5A$ $T_J = 100^{\circ}C$ $I_F = 10A$ $T_J = 100^{\circ}C$ $I_F = 20A$ $T_J = 100^{\circ}C$			1.2 0.85 1.6 1.4 2.3 1.3	V V V V V V
$E_{s/b}$	Second Breakdown Energy	$L = 3mH$ $V_{CC} = 30V$ $T_J = 100^{\circ}C$		250 250		mJ mJ
$I_{s/b}$	Second Breakdown Collector Current	$V_{CE} = 25V$	$t = 500ms$	6		A

* Pulsed : pulse duration = 300 μs , duty cycle = 1.5 %
For PNP types voltage and current values are negative.

Safe Operating Areas.

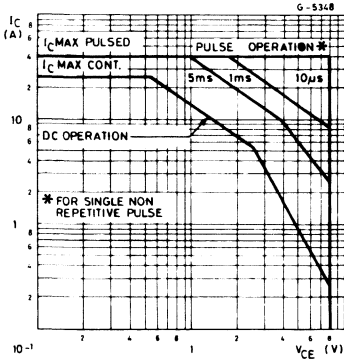

DC Current Gain (NPN type).

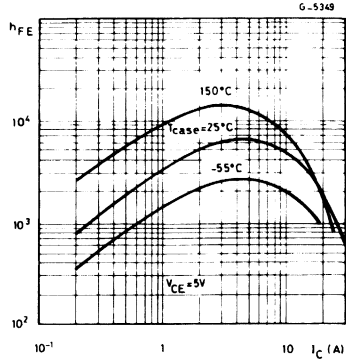

DC Current Gain (PNP type).

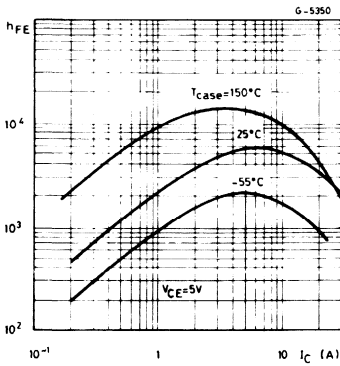
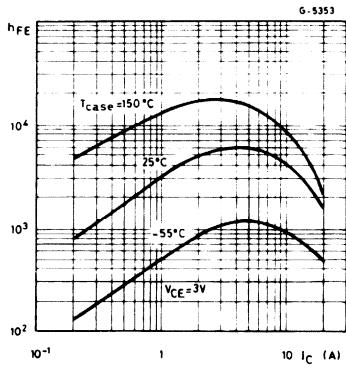
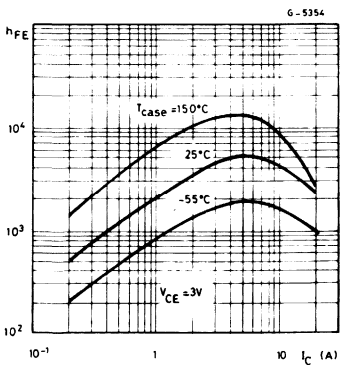

Figure 4 : DC Current Gain (NPN type).



DC Current Gain (PNP type).



Collector-emitter Saturation Voltage (NPN type).

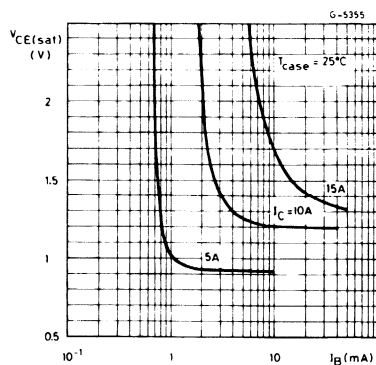

Collector-emitter Saturation Voltage (PNP type).

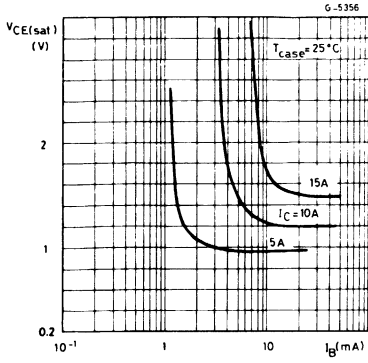

Capacitances (NPN type).

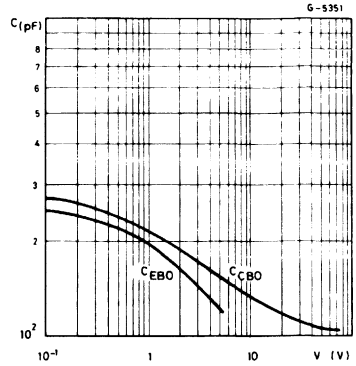

Capacitances (PNP type).

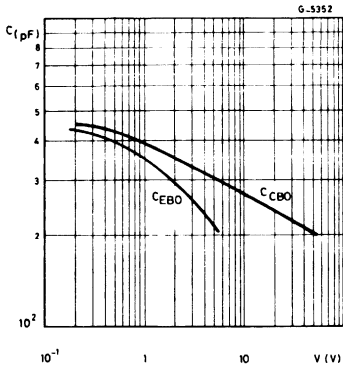

HIGH VOLTAGE, HIGH POWER, FAST SWITCHING

DESCRIPTION

The SGSD310, SGSD311 and SGSD311FI are silicon multiepitaxial planar NPN transistors in monolithic Darlingtion configuration with integrated speed-up diode, mounted respectively in the TO-3 metal case, TO-218 plastic package and ISOWATT218 fully isolated package.

No parasitic collector-emitter diode, so that an external fast recovery free wheeling diode can be added.

They are particularly suitable as output stage in high power, fast switching applications.

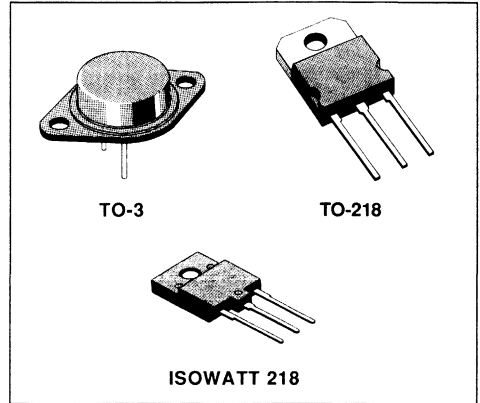

INTERNAL SCHEMATIC DIAGRAM

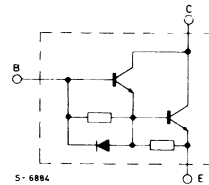

ABSOLUTE MAXIMUM RATINGS

Symbol	Parameter	Value			Unit
		TO-3	TO-218	ISOWATT218	
V_{CER}	Collector-emitter Voltage ($R_{BE} = 50\Omega$)	600			V
V_{CEO}	Collector-emitter Voltage ($I_B = 0$)	400			V
I_C	Collector-current	28			A
I_{CM}	Collector Peak Current ($t_p < 10ms$)	40			A
I_B	Base Current	6			A
I_{BM}	Base Peak Current ($t_p < 10ms$)	12			A
P_{tot}	Total Power Dissipation at $T_c < 25^\circ C$	150	125	60	W
T_{stg}	Storage Temperature	- 65 to 175	- 65 to 150	- 65 to 150	$^\circ C$
T_j	Max. Operating Junction Temperature	175	150	150	$^\circ C$

THERMAL DATA

			TO-3	TO-218	ISOWATT218	
$R_{th\ j-case}$	Thermal Resistance Junction-case	Max	1	1	2.08	°C/W

ELECTRICAL CHARACTERISTICS ($T_{case} = 25\text{ °C}$ unless otherwise specified)

Symbol	Parameter	Test Conditions	Min.	Typ.	Max.	Unit
I_{CEV}	Collector Cutoff Current ($V_{BE} = -1.5\text{ V}$)	$V_{CE} = 600\text{ V}$ $V_{CE} = 600\text{ V}$ $T_{case} = 100\text{ °C}$			100 2	μA mA
I_{EBO}	Emitter Cutoff Current ($I_C = 0$)	$V_{EB} = 2\text{ V}$			30	mA
$V_{CE0(sus)}^*$	Collector-emitter Sustaining Voltage	$I_C = 100\text{ mA}$	400			V
$V_{CE(sat)}^*$	Collector-emitter Saturation Voltage	$I_C = 10\text{ A}$ $I_B = 0.5\text{ A}$ $I_C = 18\text{ A}$ $I_B = 1.8\text{ A}$ $I_C = 22\text{ A}$ $I_B = 2.2\text{ A}$ $I_C = 28\text{ A}$ $I_B = 5.6\text{ A}$			2 2.5 3 5	V V V V
$V_{BE(sat)}^*$	Base-emitter Saturation Voltage	$I_C = 10\text{ A}$ $I_B = 0.5\text{ A}$ $I_C = 18\text{ A}$ $I_B = 1.8\text{ A}$ $I_C = 22\text{ A}$ $I_B = 2.2\text{ A}$			2.5 3 3.3	V V V
h_{FE}^*	DC Current Gain	$I_C = 10\text{ A}$ $V_{CE} = 5\text{ V}$ $I_C = 18\text{ A}$ $V_{CE} = 5\text{ V}$	30 20			
I_{OI}	Output Current Overload	Accidental Overload Switch-off Current $V_{clamp} = 400\text{ V}$ $L = 100\text{ }\mu\text{H}$ $t_{OI} = 10\text{ }\mu\text{s}$ $T_j = 125\text{ °C}$	28			A

RESISTIVE SWITCHING TIMES

Symbol	Parameter	Test Conditions	Min.	Typ.	Max.	Unit.
t_{on}	Turn-on Time	$V_{CC} = 250\text{ V}$ $I_C = 10\text{ A}$ $I_{B1} = 0.5\text{ A}$ $V_{BE(off)} = -5\text{ V}$			0.6	μs
t_s	Storage Time				1.5	μs
t_f	Fall Time				0.6	μs

INDUCTIVE SWITCHING TIMES

Symbol	Parameter	Test Conditions	Min.	Typ.	Max.	Unit.
t_s	Storage Time	$V_{clamp} = 250\text{ V}$ $I_C = 10\text{ A}$ $I_{B1} = 0.5\text{ A}$ $V_{BE(off)} = -5\text{ V}$ $L = 180\text{ }\mu\text{H}$			1.5	μs
t_f	Fall Time				0.5	μs
t_s	Storage Time	$V_{clamp} = 250\text{ V}$ $I_C = 20\text{ A}$ $I_{B1} = 2\text{ A}$ $V_{BE(off)} = -5\text{ V}$ $L = 180\text{ }\mu\text{H}$			1.5	μs
t_f	Fall Time				0.7	μs

* Pulsed : pulse duration = 300 μs , duty cycle = 1.5%.

Safe Operating Areas (TO-3).

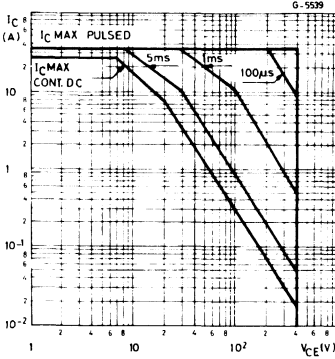

Safe Operating Areas (TO-218, ISOWATT218).

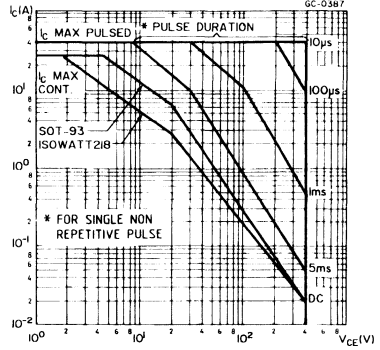

DC Current Gain.

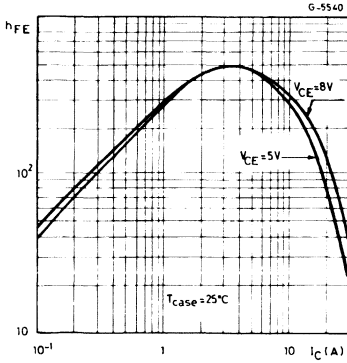

DC Current Gain.

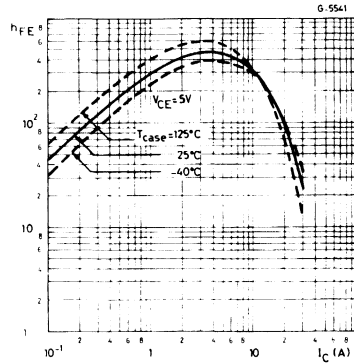

Collector-emitter Saturation Voltage.

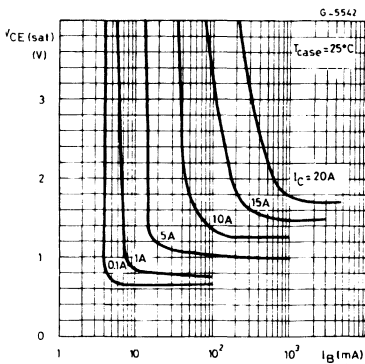

Base-emitter Saturation Voltage.

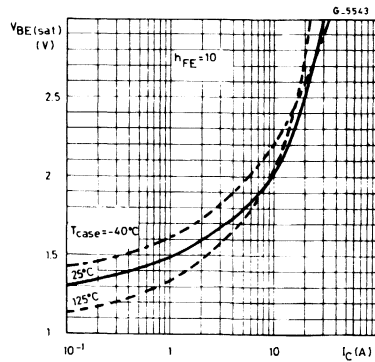

Collector-emitter Saturation Voltage.

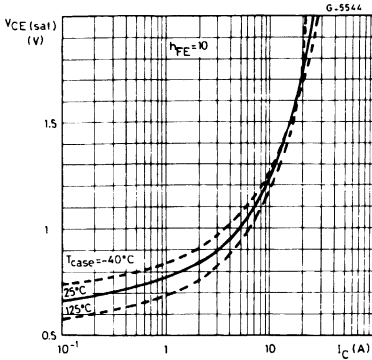

Collector-emitter Saturation Voltage Dynamic (test circuit fig. 2).

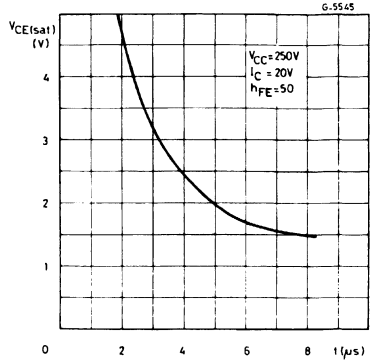

Switching Times Resistive Load (test circuit fig. 2).

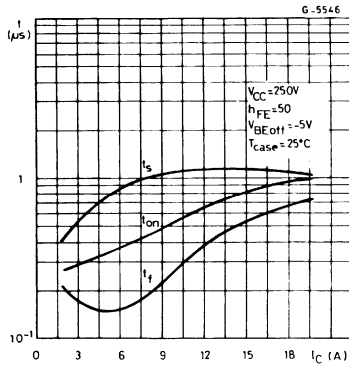

Switching Times Percentage Variation vs. Tcase.

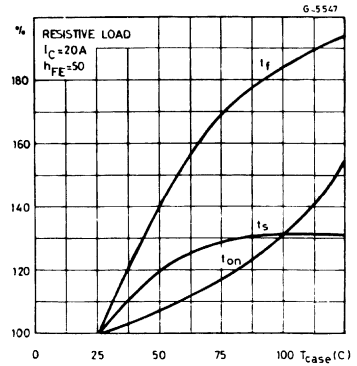

Switching Times Inductive Load (fig. 2).

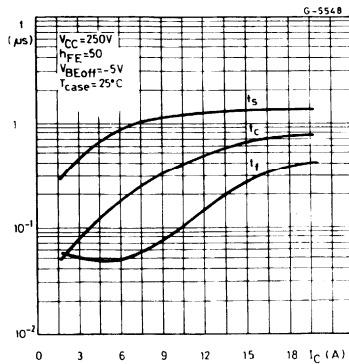

Switching Times Percentage Variation vs. Tcase.

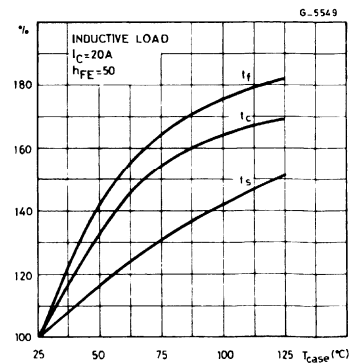

Clamped Reverse bias Safe Operating Area.

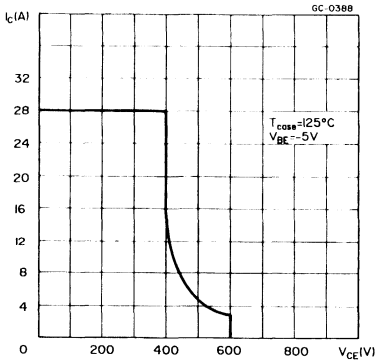

TEST CIRCUIT

Figure 2.

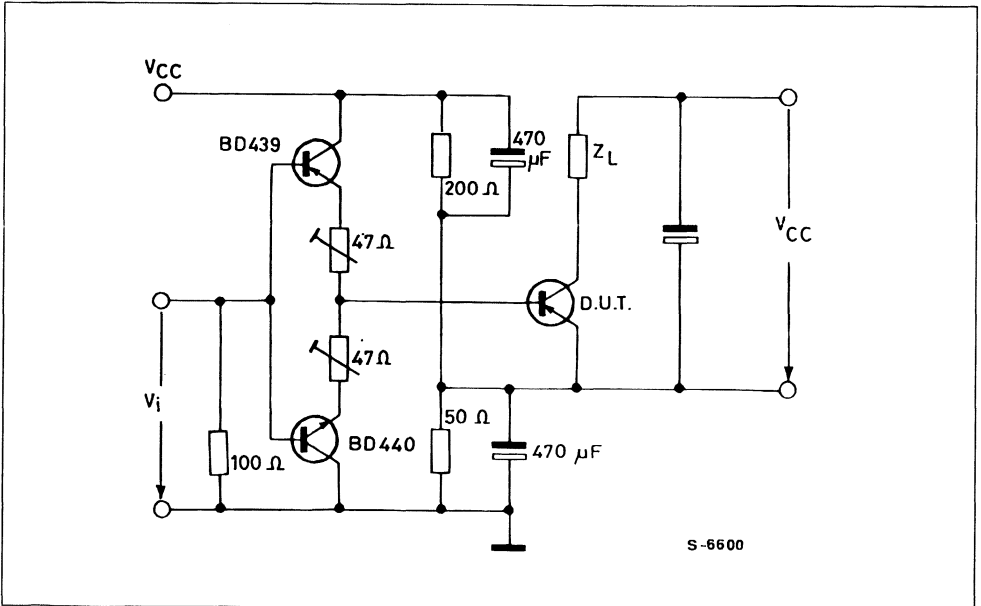

ISOWATT218 PACKAGE CHARACTERISTICS AND APPLICATION

ISOWATT218 is fully isolated to 4000V dc. Its thermal impedance, given in the data sheet, is optimised to give efficient thermal conduction together with excellent electrical isolation. The structure of the case ensures optimum distances between the pins and heatsink. These distances are in agreement with VDE and UL creepage and clearance standards. The ISOWATT218 package eliminates the need for external isolation so reducing fixing hardware.

The package is supplied with leads longer than the standard TO-218 to allow easy mounting on pcbs.

Accurate moulding techniques used in manufacture assures consistent heat spreader-to-heatsink capacitance.

ISOWATT218 thermal performance is equivalent to that of the standard part, mounted with a 0.1mm mica washer. The thermally conductive plastic has a higher breakdown rating and is less fragile than mica or plastic sheets. Power derating for ISOWATT218 packages is determined by :

$$P_D = \frac{T_j - T_c}{R_{th}}$$

THERMAL IMPEDANCE OF ISOWATT218 PACKAGE

Fig. 3 illustrates the elements contributing to the thermal resistance of a transistor heatsink assembly, using ISOWATT218 package.

The total thermal resistance $R_{th(tot)}$ is the sum of each of these elements. The transient thermal impedance, Z_{th} for different pulse durations can be estimated as follows :

- 1 - For a short duration power pulse of less than 1ms :

$$Z_{th} = R_{thJ-C}$$

- 2 - For an intermediate power pulse of 5ms to 50ms seconds :

$$Z_{th} = R_{thJ-C}$$

- 3 - For long power pulses of the order of 500ms seconds or greater :

$$Z_{th} = R_{thJ-C} + R_{thC-HS} + R_{thHS-amb}$$

It is often possible to discern these areas on transient thermal impedance curves.

Figure 3.

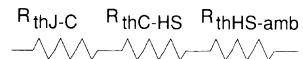

NPN HIGH VOLTAGE DARLINGTON

- VERY HIGH GAIN
- HIGH VOLTAGE
- HIGH RUGGEDNESS BY INTEGRATED HIGH VOLTAGE ZENER
- AUTOMOTIVE FUNCTIONAL TEST

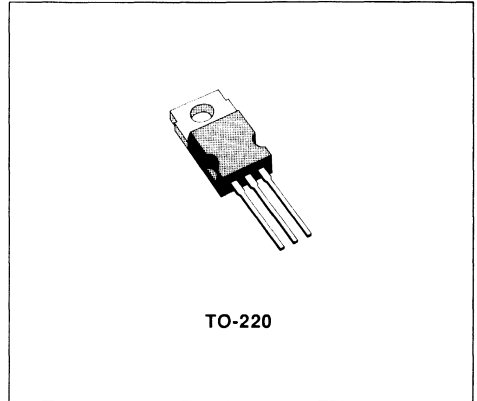

INTERNAL SCHEMATIC DIAGRAM

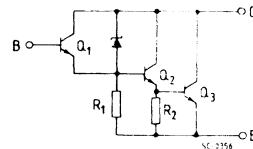

DESCRIPTION

NPN multi-epitaxial planar integrated trivalent in TO-220 plastic package, intended for use in high performance electronic ignition or inductive switching circuit.

ABSOLUTE MAXIMUM RATINGS

Symbol	Parameter	Value	Unit
V_{CEO}	Collector-emitter Voltage ($I_B = 0$)	400	V
V_{EBO}	Emitter-base Voltage ($I_C = 0$)	8	V
I_C	Collector Current	5	A
I_{CM}	Collector Peak Current	8	A
I_B	Base Current	1	A
P_{Tot}	Total Dissipation at $T_C < 25^\circ\text{C}$	50	W
T_{stg}	Storage Temperature	- 55 to 150	$^\circ\text{C}$
T_j	Max. Operating Junction Temperature	150	$^\circ\text{C}$

THERMAL DATA

$R_{th(j-case)}$	Thermal Resistance Junction-case	max	2.5	$^{\circ}C/W$
------------------	----------------------------------	-----	-----	---------------

ELECTRICAL CHARACTERISTICS ($T_{case} = 25^{\circ}C$ unless otherwise specified)

Symbol	Parameter	Test Conditions		Min.	Typ.	Max.	Unit
I_{EBO}	Emitter Cutoff Current ($I_C = 0$)	$V_{EB} = 8V$				100	μA
I_{CES}	Collector Cutoff Current ($V_{BE} = 0$)	$V_{CE} = 400V$				100	μA
$V_{CEO(sus)*}$	Collector-emitter Sustaining Voltage	$I_C = 50mA$		400			V
$V_{CE(sat)*}$	Collector-emitter saturation Voltage	$I_C = 3A$	$I_B = 3mA$			4	V
		$I_C = 2.5A$	$I_B = 1mA$			4	V
$V_{BE(sat)*}$	Base-emitter Saturation Voltage	$I_C = 3A$	$I_B = 3mA$			3.5	V
h_{FE*}	DC Current Gain	$I_C = 1A$	$V_{CE} = 5V$	7000			
$E_{s/b}$	Second Breakdown Energy	$I_C = 4A$	$L = 10mH$	80			mJ

* Pulsed : pulse duration = 300 μs , duty cycle = 1.5%.

HIGH VOLTAGE, HIGH POWER, FAST SWITCHING

DESCRIPTION

The SGSD00030, SGSD00031 and SGSD00031FI are silicon multiepitaxial planar NPN transistors in monolithic Darlington configuration with integrated speed-up diode, mounted respectively in the TO-3 metal case, TO-218 plastic package and ISO-WATT218 fully isolated package.

No parasitic collector-emitter diode, so that an external fast recovery free wheeling can be added.

They are particularly suitable as output stage in high power, fast switching applications.

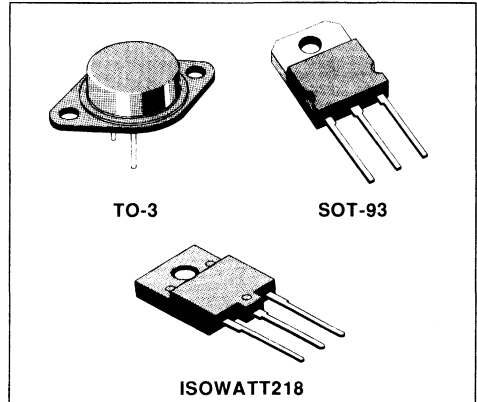

INTERNAL SCHEMATIC DIAGRAM

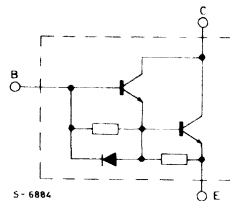

ABSOLUTE MAXIMUM RATINGS

Symbol	Parameter	Value			Unit
		TO-3	TO-218	ISOWATT218	
V_{CER}	Collector-emitter Voltage ($R_{BE} = 50\Omega$)	650			V
V_{CEO}	Collector-emitter Voltage ($I_B = 0$)	400			V
I_C	Collector-current	28			A
I_{CM}	Collector Peak Current ($t_p < 10ms$)	40			A
I_B	Base Current	6			A
I_{BM}	Base Peak Current ($t_p < 10 ms$)	12			A
P_{Tot}	Total Power Dissipation at $T_c < 25^\circ C$	150	125	60	W
T_{stg}	Storage Temperature	- 65 to 175	- 65 to 150	- 65 to 150	$^\circ C$
T_j	Max. Operating Junction Temperature	175	150	150	$^\circ C$

THERMAL DATA

			TO-3	TO-218	ISOWATT218	
$R_{th\ j-case}$	Thermal Resistance Junction-case	Max	1	1	2.08	°C/W

ELECTRICAL CHARACTERISTICS ($T_{case} = 25\text{ °C}$ unless otherwise specified)

Symbol	Parameter	Test Conditions	Min.	Typ.	Max.	Unit
I_{CEV}	Collector Cutoff Current ($V_{BE} = -15\text{ V}$)	$V_{CE} = 600\text{ V}$ $V_{CE} = 600\text{ V}$ $T_{case} = 100\text{ °C}$			100 2	μA mA
I_{EBO}	Emitter Cutoff Current ($I_C = 0$)	$V_{EB} = 2\text{ V}$			30	mA
$V_{CEO(sus)*}$	Collector-emitter Sustaining Voltage	$I_C = 100\text{ mA}$	400			V
$V_{CE(sat)*}$	Collector-emitter Saturation Voltage	$I_C = 10\text{ A}$ $I_B = 0.1\text{ A}$ $I_C = 18\text{ A}$ $I_B = 1.8\text{ A}$			2.5 3.5	V V
h_{FE}^*	DC Current Gain	$I_C = 10\text{ A}$ $V_{CE} = 5\text{ V}$ $I_C = 18\text{ A}$ $V_{CE} = 5\text{ V}$	30 20			
I_{ol}	Output Current Overload	Accidental Overload Switch-off Current $V_{clamp} = 400\text{ V}$ $L = 100\text{ }\mu\text{H}$ $t_{ol} = 10\text{ }\mu\text{s}$ $T_j = 125\text{ °C}$	28			A

RESISTIVE SWITCHING TIMES

Symbol	Parameter	Test Conditions	Min.	Typ.	Max.	Unit.
t_s	Turn-on Time	$V_{CC} = 250\text{ V}$ $I_C = 12\text{ A}$ $I_{B1} = 0.1\text{ A}$ $V_{BE(off)} = -5\text{ V}$			0.6	μs
t_s	Storage Time				1.5	μs
t_f	Fall Time				0.6	μs

INDUCTIVE SWITCHING TIMES

Symbol	Parameter	Test Conditions	Min.	Typ.	Max.	Unit.
t_s	Storage Time	$V_{clamp} = 250\text{ V}$ $I_C = 12\text{ A}$ $I_{B1} = 0.1\text{ A}$ $V_{BE(off)} = -5\text{ V}$ $L = 180\text{ }\mu\text{H}$			1.5	μs
t_f	Fall Time				0.5	μs
t_s	Storage Time	$V_{clamp} = 250\text{ V}$ $I_C = 18\text{ A}$ $I_{B1} = 1.8\text{ A}$ $V_{BE(off)} = -5\text{ V}$ $L = 180\text{ }\mu\text{H}$			1.5	μs
t_f	Fall Time				0.7	μs

* Pulsed : pulse duration = 300 μs , duty cycle = 1.5%.

Safe Operating Areas (TO-3).

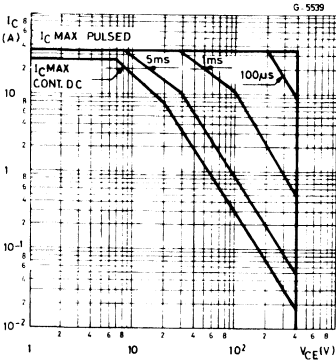

Safe Operating Areas (TO-218, ISOWATT218).

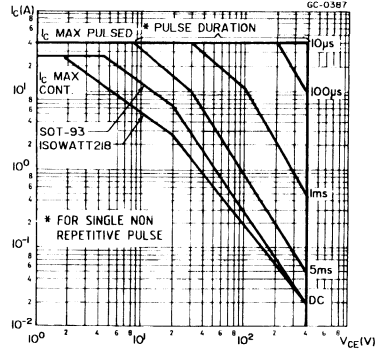

DC Current Gain.

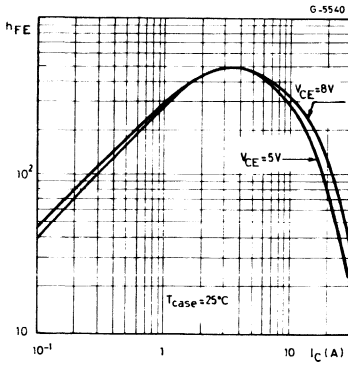

DC Current Gain.

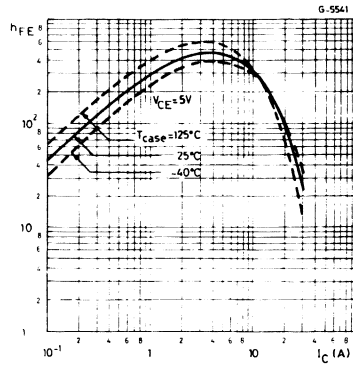

Collector-emitter Saturation Voltage.

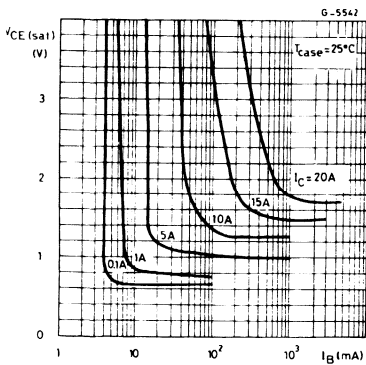

Base-emitter Saturation Voltage.

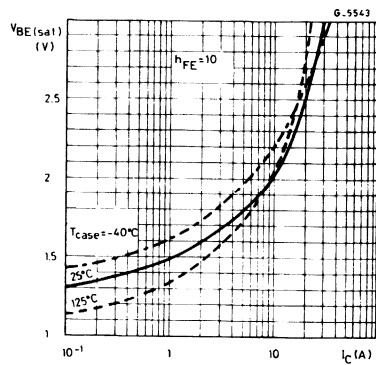

Collector-emitter Saturation Voltage.

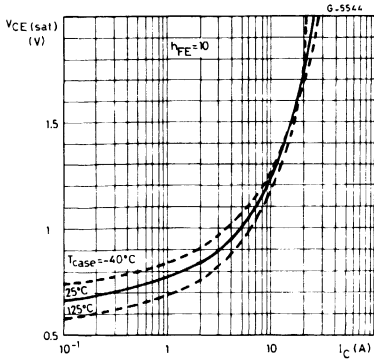

Collector-emitter Saturation Voltage Dynamic (test circuit fig. 2).

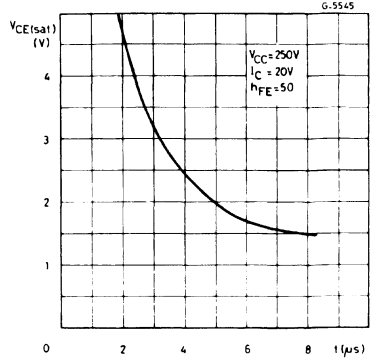

Switching Times Resistive Load (test circuit fig. 1).

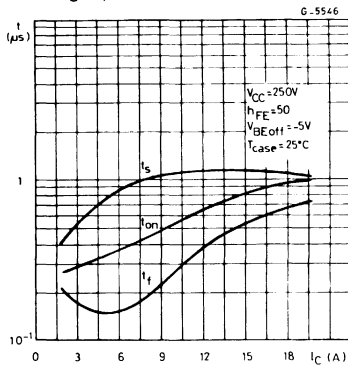

Switching Times Percentage Variation vs. Tcase.

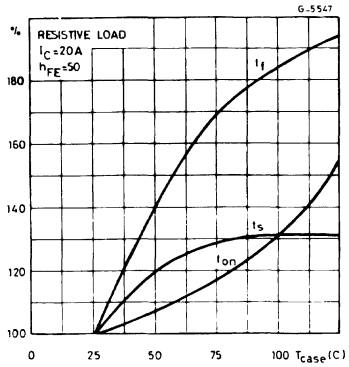

Switching Times Inductive Load (test circuit fig. 1).

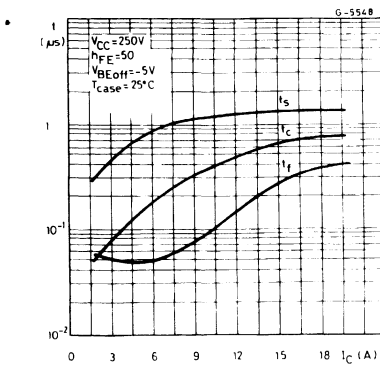

Switching Times Percentage Variation vs. Tcase.

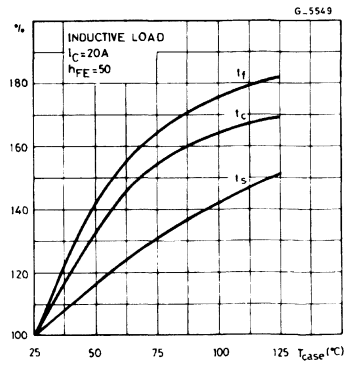
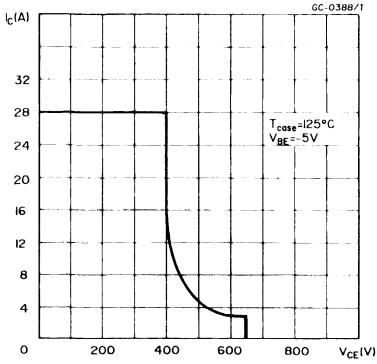
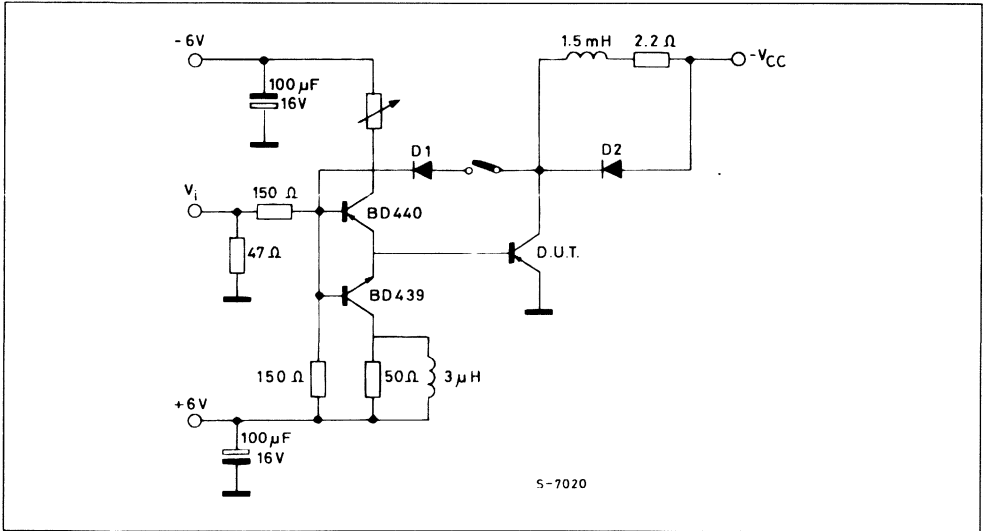

Figure 12 : Clamped Reverse Bias Safe Operating Area.



SWITCHING TIMES TEST CIRCUITS

Figure 1.



SWITCHING TIMES TEST CIRCUITS (continued)

Figure 2.

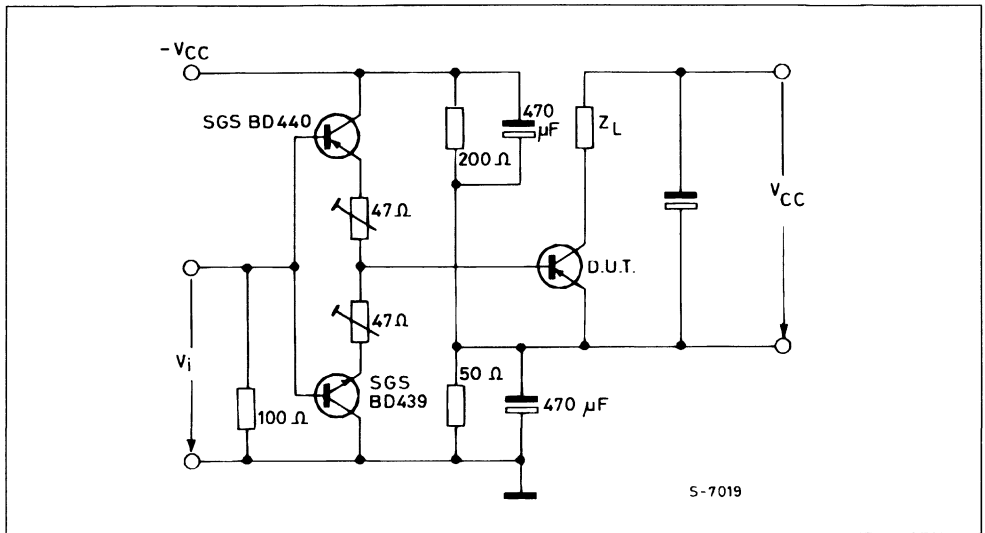

S-7019

ISOWATT218 PACKAGE CHARACTERISTICS AND APPLICATION

ISOWATT218 is fully isolated to 4000V dc. Its thermal impedance, given in the data sheet, is optimised to give efficient thermal conduction together with excellent electrical isolation.

The structure of the case ensures optimum distances between the pins and heatsink. These distances are in agreement with VDE and UL creepage and clearance standards. The ISOWATT218 package eliminates the need for external isolation so reducing fixing hardware.

The package is supplied with leads longer than the standard TO-218 to allow easy mounting on pcbs. Accurate moulding techniques used in manufacture

assures consistent heat spreader-to-heatsink capacitance.

ISOWATT218 thermal performance is equivalent to that of the standard part, mounted with a 0.1 mm mica washer.

The thermally conductive plastic has a higher breakdown rating and is less fragile than mica or plastic sheets.

Power derating for ISOWATT218 packages is determined by :

$$P_D = \frac{T_J - T_C}{R_{th}}$$

THERMAL IMPEDANCE OF ISOWATT218 PACKAGE

Figure 2 illustrates the elements contributing to the thermal resistance of a transistor heatsink assembly, using ISOWATT218 package.

The total thermal resistance $R_{th(tot)}$ is the sum of each of these elements.

The transient thermal resistance impedance, Z_{th} for different pulse durations can be estimated as follows :

1. For a short duration power pulse of less than 1ms :

$$Z_{th} < R_{thJ-C}$$

2. For an intermediate power pulse of 5ms to 50ms seconds :

$$Z_{th} = R_{thJ-C}$$

3. For long power pulses of the order of 500ms seconds or greater :

$$Z_{th} = R_{thJ-C} + R_{thC-HS} + R_{thHS-amb}$$

It is often possible to discern these areas on transient thermal impedance curves.

Figure 2.

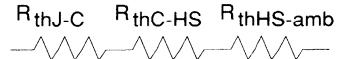

HIGH VOLTAGE FAST SWITCHING NPN DARLINGTON

ADVANCE DATA

- HIGH VOLTAGE
- HIGH GAIN
- FAST SWITCHING
- GOOD RBSOA

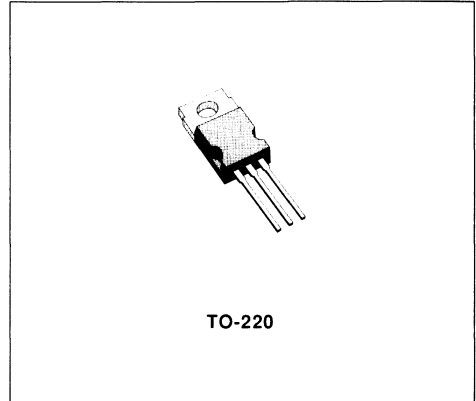

DESCRIPTION

The SGSD00055 is a silicon multi-epitaxial planar NPN transistor in monolithic Darlington configuration with integrated speed-up diode mounted in TO-220 plastic package. It is a fast switching high voltage device intended for off-line flyback SMPS and monochrome deflection.

INTERNAL SCHEMATIC DIAGRAM

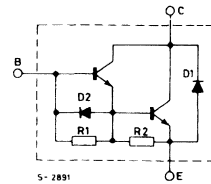

ABSOLUTE MAXIMUM RATINGS

Symbol	Parameter	Value	Unit
V_{CES}	Collector-emitter Voltage ($V_{BE} = 0$)	1000	V
V_{CEV}	Collector-emitter Voltage ($V_{BE} = -1.5V$)	1000	V
V_{CEO}	Collector-emitter Voltage ($I_B = 0$)	400	V
V_{EBO}	Emitter-base Voltage ($I_C = 0$)	7	V
I_C	Collector Current	7	A
I_{CM}	Collector Peak Current ($t_p < 1ms$)	10	A
I_B	Base Current	3	A
P_{Tot}	Total Dissipation at $T_c < 25^\circ C$	75	W
T_{stg}	Storage Temperature	-65 to 150	$^\circ C$
T_j	Max. Operating Junction Temperature	150	$^\circ C$

THERMAL DATA

$R_{thj-case}$	Thermal Resistance Junction-case	max	1.67	°C/W
----------------	----------------------------------	-----	------	------

ELECTRICAL CHARACTERISTICS ($T_{case} = 25^{\circ}C$ unless otherwise specified)

Symbol	Parameter	Test Conditions		Min.	Typ.	Max.	Unit
I_{CES}	Collector Cutoff Current ($V_{BE} = 0$)	$V_{CE} = 1000V$ $V_{CE} = 1000V$	$T_C = 125^{\circ}C$			200 2	μA mA
I_{CEX}	Collector Cutoff Current	$V_{CE} = 1000V$	$V_{BE} = -1.5V$			200	μA
I_{EBO}	Emitter Cutoff Current ($I_C = 0$)	$V_{EB} = 5V$				50	mA
$V_{CEO(sus)}^*$	Collector Emitter Sustaining Voltage	$I_C = 0.2A$ $L = 25mH$	$V_{CL} = 400V$	400			V
V_{EBO}	Emitter-base Voltage ($I_C = 0$)	$I_E = 50mA$		7			V
$V_{CE(sat)}^*$	Collector-emitter Saturation Voltage	$I_C = 1.6A$ $I_C = 3A$	$I_B = 25mA$ $I_B = 200mA$			2 2.5	V V
$V_{BE(sat)}^*$	Base-emitter Saturation Voltage	$I_C = 1.6A$ $I_C = 3A$	$I_B = 25mA$ $I_B = 200mA$			2.2 3	V V
t_s t_f	Storage Time Fall Time	$V_{CC} = V_{CL} = 350V$ $V_{BB} = -5V$ $L_C = 0.9mH$	$I_C = 3A$ $I_{B1} = 0.2A$		0.8 0.15		μs μs
V_{CEW}	Maximum Collector Emitter Voltage without Snubber	$V_{CC} = V_{CL} = 400V$ $V_{BB} = -5V$ $L_C = 0.9mH$	$I_C = 8A$ $I_{B1} = 0.5A$	400			V

* Pulsed : pulse duration = 300 μs , duty cycle = 1.5%.

FASTSWITCH HOLLOW-EMITTER NPN TRANSISTORS

- HIGH SWITCHING SPEED NPN POWER-TRANSISTORS
- HOLLOW EMITTER TECHNOLOGY
- HIGH VOLTAGE FOR OFF-LINE APPLICATIONS
- 70kHz SWITCHING SPEED
- LOW COST DRIVE CIRCUITS
- LOW DYNAMIC SATURATION

APPLICATIONS

- SMPS

DESCRIPTION

Hollow emitter FASTSWITCH NPN power transistors have been specifically designed for 220V (and 117V with input doubler) off-line switching power

supply applications. Hollow emitter transistors can operate up to 70kHz with low cost drive circuits. These devices are suitable for flyback and forward low power converters, 140W to 250W, when normal high voltage peaks associated with single transistor design are limited by a transformer clamp winding or over voltage snubbing at 850V. When used in conjunction with a low voltage Power MOSFET in emitter switch configuration, they can operate at up to 100kHz.

Hollow emitter FASTSWITCH transistors are available in TO-220, TO-218, ISOWATT220 and ISOWATT218 packages. The ISOWATT218 conforms to the creepage distance and isolation requirements of VDE, IEC, and UL specifications.

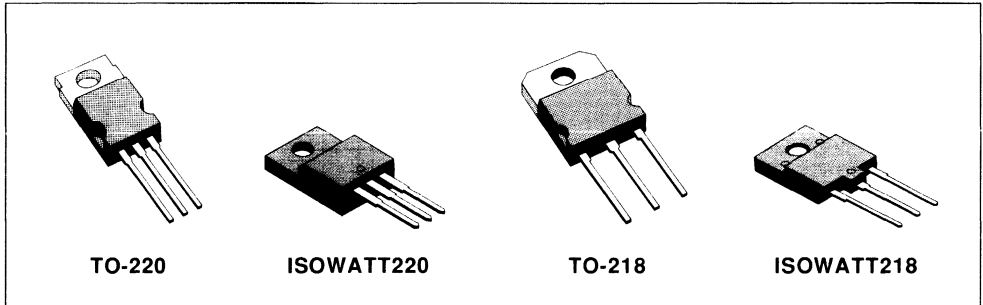

ABSOLUTE MAXIMUM RATINGS

Symbol	Parameter	SGS				Unit
		F321	IF321	F421	IF421	
V_{CES}	Collector - Emitter Voltage ($V_{BE} = 0$)	850				V
V_{CEO}	Collector - Emitter Voltage ($I_B = 0$)	400				V
V_{EBO}	Emitter - Base Voltage ($I_C = 0$)	7				V
I_C	Collector Current	5				A
I_{CM}	Collector Peak Current ($t_p < 5ms$)	10				A
I_B	Base Current	3				A
I_{BM}	Base Peak Current ($t_p < 5ms$)	6				A
P_{tot}	Total Dissipation at $T_c \leq 25^\circ C$	70	35	80	45	W
T_{stg}	Storage Temperature - 65 to	150	150	150	150	$^\circ C$
T_j	Junction Temperature	150	150	150	150	$^\circ C$

THERMAL DATA

			SGS				°C/W
			F321	IF321	F421	IF521	
R _{thj-case}	Thermal Resistance Junction-case	Max	1.78	3.57	1.56	2.78	

ELECTRICAL CHARACTERISTICS (T_{case} = 25°C unless otherwise specified)

Symbol	Parameter	Test Conditions	Min.	Typ.	Max.	Unit
I _{CES}	Collector Cutoff Current (V _{BE} = 0)	V _{CE} = 850V			200	μA
I _{CEO}	Collector Cutoff Current (I _B = 0)	V _{CE} = 380V V _{CE} = 400V			200 2	μA mA
I _{EBO}	Emitter Cutoff Current (I _C = 0)	V _{EB} = 7V			1	mA
V _{CEO (sus)*}	Collector Emitter Sustaining Voltage	I _C = 0.1A	400			V
V _{CE (sat)*}	Collector Emitter Saturation Voltage	I _C = 3.5A I _B = 0.7A I _C = 2.5A I _B = 0.35A			1.5 1.5	V V
V _{BE (sat)*}	Base Emitter Saturation Voltage	I _C = 3.5A I _B = 0.7A I _C = 2.5A I _B = 0.35A			1.5 1.5	V V

RESISTIVE LOAD

Symbol	Parameter	Test Conditions	Min.	Typ.	Max.	Unit
t _{on}	Turn-on Time	I _C = 3.5A V _{CC} = 250V I _{B1} = 0.7A I _{B2} = -2I _{B1}		0.5	1	μs
t _s	Storage Time			1.5	2.5	μs
t _f	Fall Time			0.18	0.3	μs
t _{on}	Turn-on Time	I _C = 3.5A V _{CC} = 250V I _{B1} = 0.7A I _{B2} = -2I _{B1} with Antisaturation Network		0.5		μs
t _s	Storage Time			1.1		μs
t _f	Fall Time			0.13		μs
t _{on}	Turn-on Time	I _C = 3.5A V _{CC} = 250V I _{B1} = 0.7A V _{BE(off)} = -5V		0.5		μs
t _s	Storage Time			1.1		μs
t _f	Fall Time			0.13		μs

INDUCTIVE LOAD

Symbol	Parameter	Test Conditions	Min.	Typ.	Max.	Unit
t _s	Storage Time	I _C = 3.5A h _{FE} = 5 V _{CL} = 350V V _{BE(off)} = -5V L = 300μH R _{B(off)} = 2Ω		1	2	μs
t _f	Fall Time			0.1	0.2	μs
t _s	Storage Time	I _C = 3.5A h _{FE} = 5 V _{CL} = 350V V _{BE(off)} = -5V L = 300μH R _{B(off)} = 2Ω T _c = 100°C			3	μs
t _f	Fall Time				0.3	μs

* Pulsed : Pulse duration = 300μs, duty cycle = 1.5%

Safe Operating Areas

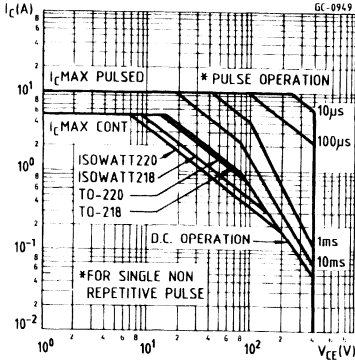

Reverse Biased Safe Operating Area

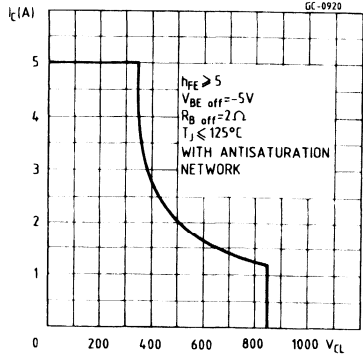

DC Current Gain

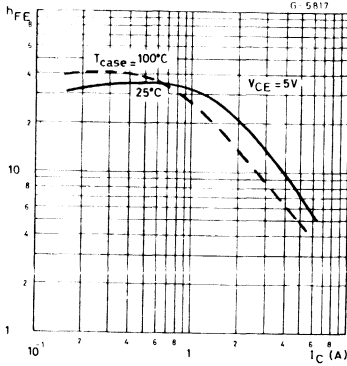

Collector-emitter Saturation Voltage

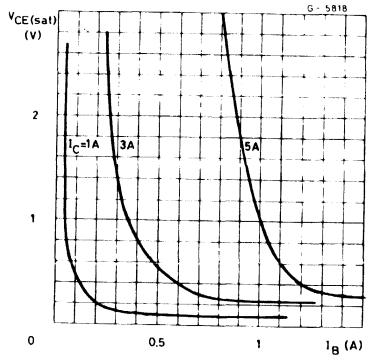

Collector-emitter Saturation Voltage

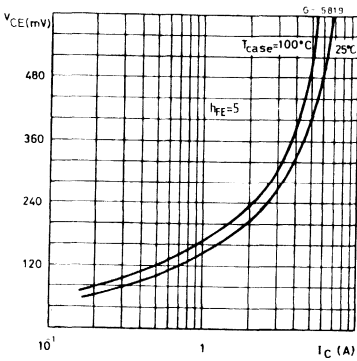

Base-emitter Saturation Voltage

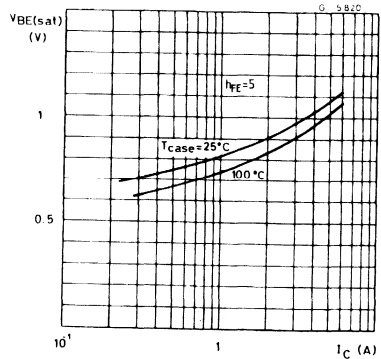

Resistive Load Switching Times

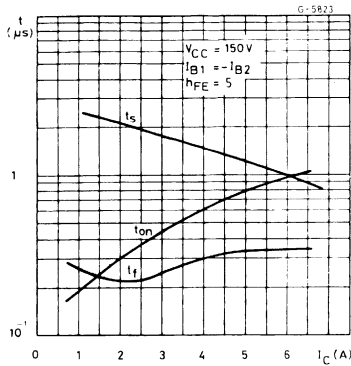

Inductive Load Switching Times

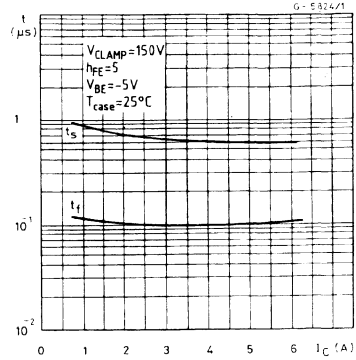

Switching Times Percentage Variation

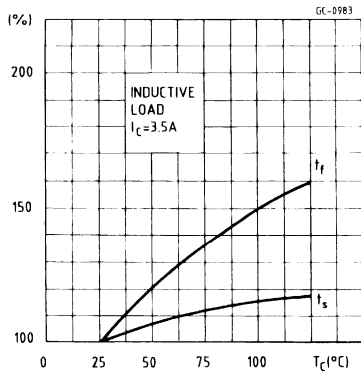

ISOWATT PACKAGES CHARACTERISTICS AND APPLICATION

The ISOWATT220 and ISOWATT218 are fully isolated packages. The ISOWATT220 is isolated to 2000V dc and the ISOWATT218 to 4000V dc. Their thermal impedance, given in the datasheet, is optimised to give efficient thermal conduction together with excellent electrical isolation.

The structure of the case ensures optimum distances between the pins and heatsink. For the ISOWATT218 these distances are in agreement with VDE and UL creepage and clearance standards. The ISOWATT218 is supplied with longer leads than the standard TO-218 to allow easy mounting on PCB's. The ISOWATT220 and ISOWATT218 packages eliminate the need for external isolation

so reducing fixing hardware. Accurate moulding techniques used in manufacture assures consistent heat spreader-to-heatsink capacitance.

The thermal performance of these packages is better than that of the standard part mounted with a 0.1mm mica washer. The thermally conductive plastic has a higher breakdown rating and is less fragile than mica or plastic sheets. Power derating for these ISOWATT packages is determined by :

$$P_D = \frac{T_J - T_C}{R_{th}}$$

THERMAL IMPEDANCE OF ISOWATT PACKAGES

Fig. 1 illustrates the elements contributing to the thermal resistance of a transistor heatsink assembly, using ISOWATT packages.

The total thermal resistance $R_{th(tot)}$ is the sum of each of these elements. The transient thermal impedance, Z_{th} for different pulse durations can be estimated as follows :

- 1 - For a short duration power pulse of less than 1ms :

$$Z_{th} < R_{thJ-C}$$

- 2 - For an intermediate power pulse of 5ms to 50ms seconds :

$$Z_{th} = R_{thJ-C}$$

- 3 - For long power pulses of the order of 500ms seconds or greater :

$$Z_{th} = R_{thJ-C} + R_{thC-HS} + R_{thHS-amb}$$

It is often possible to discern these areas on transient thermal impedance curves.

Figure 1.

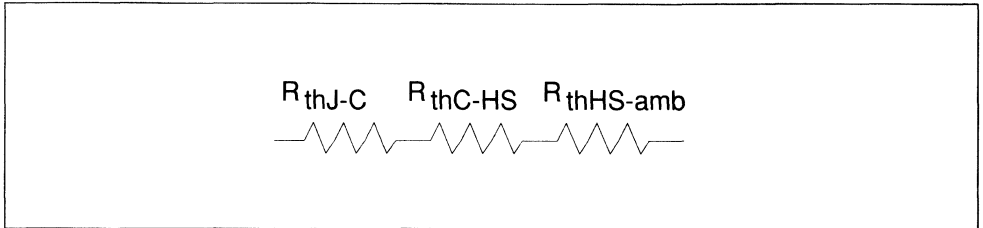

FASTSWITCH HOLLOW-EMITTER NPN TRANSISTORS

- HIGH SWITCHING SPEED NPN POWER TRANSISTORS
- HOLLOW EMITTER TECHNOLOGY
- FOR FAST SWITCHING
- HIGH VOLTAGE FOR OFF-LINE APPLICATIONS
- 70kHz SWITCHING SPEED
- LOW COST DRIVE CIRCUITS
- LOW DYNAMIC SATURATION

APPLICATIONS

- SMPS

DESCRIPTION

Hollow emitter FASTSWITCH NPN power transistors have been specifically designed for 220V (and

117V with input doubler) off-line switching power supply applications. Hollow emitter transistors can operate up to 70kHz with low cost drive circuits. These devices are suitable for flyback and forward low power converters (100W to 250W) where normal high voltage peaks, associated with single transistor design, are limited by a transformer clamp winding or over voltage snubbing at 1000V. When used in conjunction with a low voltage Power MOSFET in emitter switch configuration, they can operate at up to 100kHz.

Hollow emitter FASTSWITCH transistors are available in TO-220, TO-218, ISOWATT220 and ISOWATT218 packages. The ISOWATT218 conforms to the creepage distance and isolation requirements of VDE, IEC, and UL specifications.

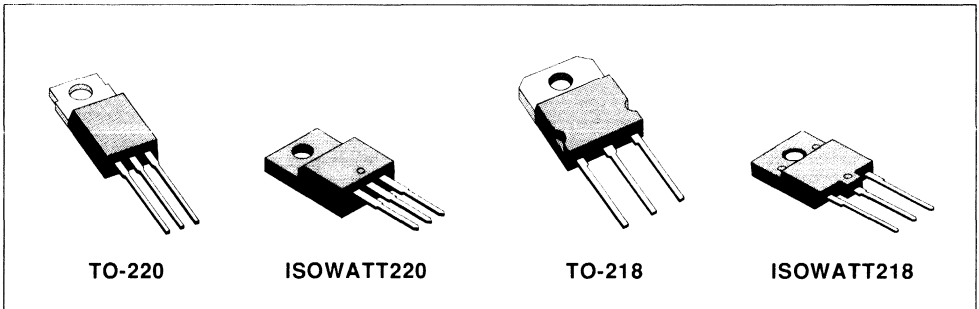

ABSOLUTE MAXIMUM RATINGS

Symbol	Parameter	SGS				Unit
		F323	IF323	F423	IF423	
V_{CES}	Collector - Emitter Voltage ($V_{BE} = 0$)	1000				V
V_{CEO}	Collector - Emitter Voltage ($I_B = 0$)	450				V
V_{EBO}	Emitter - Base Voltage ($I_C = 0$)	7				V
I_C	Collector Current	5				A
I_{CM}	Collector Peak Current ($t_p < 5ms$)	10				A
I_B	Base Current	3				A
I_{BM}	Base Peak Current ($t_p < 5ms$)	6				A
P_{tot}	Total Dissipation at $T_c \leq 25^\circ C$	70	35	80	45	W
T_{stg}	Storage Temperature - 65 to	150	150	150	150	$^\circ C$
T_j	Junction Temperature	150	150	150	150	$^\circ C$

THERMAL DATA

			SGS				
			F323	IF323	F423	IF423	
R _{thj-case}	Thermal Resistance Junction-case	Max	1.78	3.57	1.56	2.78	°C/W

ELECTRICAL CHARACTERISTICS (T_{case} = 25°C unless otherwise specified)

Symbol	Parameter	Test Conditions	Min.	Typ.	Max.	Unit
I _{CES}	Collector Cutoff Current (V _{BE} = 0)	V _{CE} = 1000V			200	µA
I _{CEO}	Collector Cutoff Current (I _B = 0)	V _{CE} = 380V V _{CE} = 450V			200 2	µA mA
I _{EBO}	Emitter Cutoff Current (I _C = 0)	V _{EB} = 7V			1	mA
V _{CEO(sus)} *	Collector Emitter Sustaining Voltage	I _C = 0.1A	450			V
V _{CE(sat)} *	Collector Emitter Saturation Voltage	I _C = 2.5A I _B = 0.5A I _C = 1.75A I _B = 0.25A			1.5 1.5	V V
V _{BE(sat)} *	Base Emitter Saturation Voltage	I _C = 2.5A I _B = 0.5A I _C = 1.75A I _B = 0.25A			1.5 1.5	V V

RESISTIVE LOAD

Symbol	Parameter	Test Conditions	Min.	Typ.	Max.	Unit
t _{on}	Turn-on Time	I _C = 2.5A V _{CC} = 250V I _{B1} = 0.5A I _{B2} = -2I _{B1}		0.5	1	µs
t _s	Storage Time			1.5	2.5	µs
t _f	Fall Time			0.18	0.3	µs
t _{on}	Turn-on Time	I _C = 2.5A V _{CC} = 250V I _{B1} = 0.5A I _{B2} = -2I _{B1} With Antisaturation Network		0.5		µs
t _s	Storage Time			1.1		µs
t _f	Fall Time			0.13		µs
t _{on}	Turn-on Time	I _C = 2.5A V _{CC} = 250V I _{B1} = 0.5A V _{BE(off)} = -5V		0.5		µs
t _s	Storage Time			1.1		µs
t _f	Fall Time			0.13		µs

INDUCTIVE LOAD

Symbol	Parameter	Test Conditions	Min.	Typ.	Max.	Unit
t _s	Storage Time	I _C = 2.5A h _{FE} = 5 V _{CL} = 350V V _{BE(off)} = -5V L = 300µH R _{B(off)} = 2Ω		1	2	µs
t _f	Fall Time				0.1	0.2
t _s	Storage Time	I _C = 2.5A h _{FE} = 5 V _{CL} = 350V V _{BE(off)} = -5V L = 300µH R _{B(off)} = 2Ω T _c = 100°C			3	µs
t _f	Fall Time					0.3

* Pulsed : Pulse duration = 300µs, duty cycle = 1.5%

Safe Operating Areas

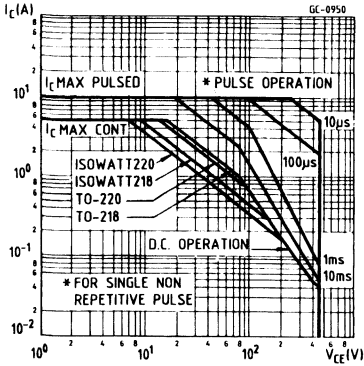

Reverse Biased Safe Operating Area

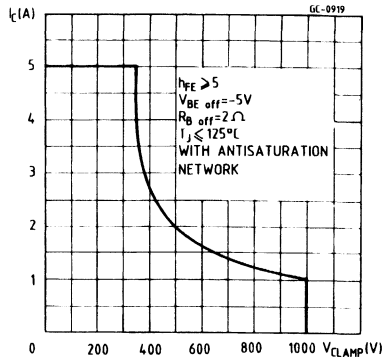

DC Current Gain

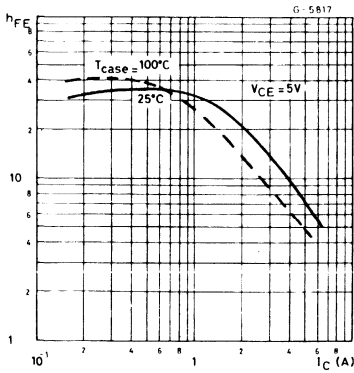

Collector-emitter Saturation Voltage

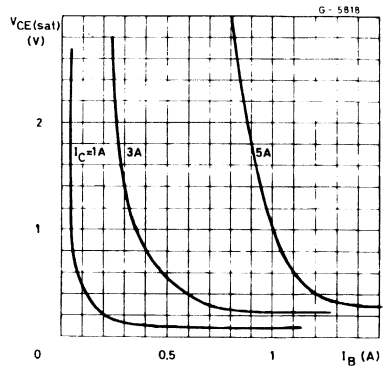

Collector-emitter Saturation Voltage

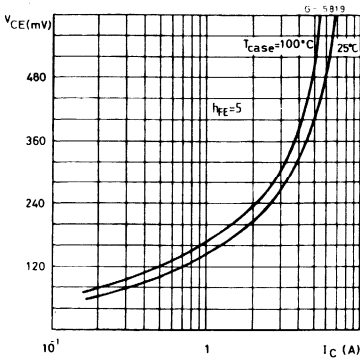

Base-emitter Saturation Voltage

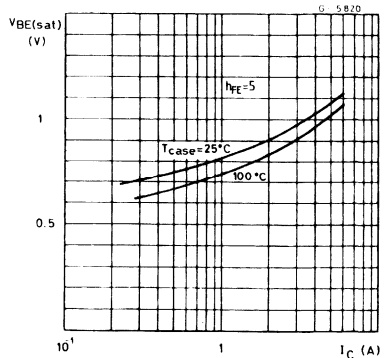

Resistive Load Switching Times

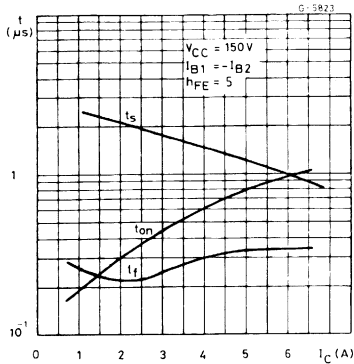

Inductive Load Switching Times

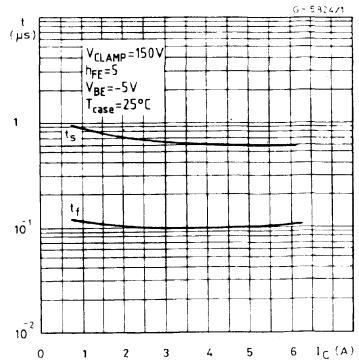

Switching Times Percentance Variation

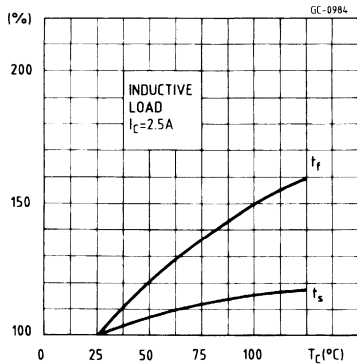

ISOWATT PACKAGES CHARACTERISTICS AND APPLICATION

The ISOWATT220 and ISOWATT218 are fully isolated packages. The ISOWATT220 is isolated to 2000V dc and the ISOWATT218 to 4000V dc. Their thermal impedance, given in the datasheet, is optimised to give efficient thermal conduction together with excellent electrical isolation.

The structure of the case ensures optimum distances between the pins and heatsink. For the ISOWATT218 these distances are in agreement with VDE and UL creepage and clearance standards. The ISOWATT218 is supplied with longer leads than the standard TO-218 to allow easy mounting on PCB's. The ISOWATT220 and ISOWATT218 packages eliminate the need for external

isolation so reducing fixing hardware. Accurate moulding techniques used in manufacture assures consistent heat spreader-to-heatsink capacitance.

The thermal performance of these packages is better than that of the standard part mounted with a 0.1mm mica washer. The thermally conductive plastic has a higher breakdown rating and is less fragile than mica or plastic sheets. Power derating for these ISOWATT packages is determined by :

$$P_D = \frac{T_j - T_c}{R_{th}}$$

THERMAL IMPEDANCE OF ISOWATT PACKAGES

Fig. 1 illustrates the elements contributing to the thermal resistance of a transistor heatsink assembly, using ISOWATT packages.

The total thermal resistance $R_{th(tot)}$ is the sum of each of these elements. The transient thermal impedance, Z_{th} for different pulse durations can be estimated as follows :

1 - For a short duration power pulse of less than 1ms :

$$Z_{th} < R_{thJ-C}$$

2 - For an intermediate power pulse of 5ms to 50ms seconds :

$$Z_{th} = R_{thJ-C}$$

3 - For long power pulses of the order of 500ms seconds or greater :

$$Z_{th} = R_{thJ-C} + R_{thC-HS} + R_{thHS-amb}$$

It is often possible to discern these areas on transient thermal impedance curves.

Figure 1.

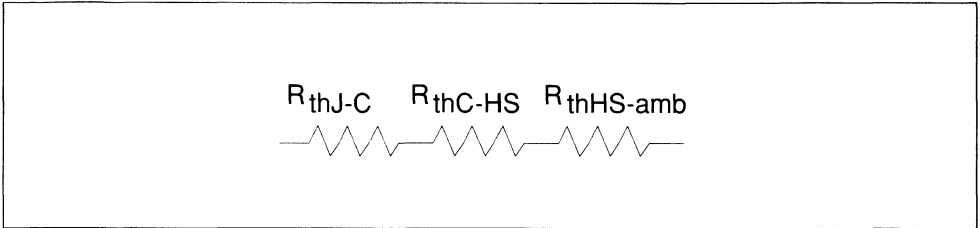

FASTSWITCH HOLLOW-EMITTER NPN TRANSISTORS

- HIGH SWITCHING SPEED NPN POWER TRANSISTORS
- HOLLOW EMITTER TECHNOLOGY
- HIGH VOLTAGE FOR OFF-LINE APPLICATIONS
- 50kHz SWITCHING SPEED
- LOW COST DRIVE CIRCUITS
- LOW DYNAMIC SATURATION

APPLICATIONS

- SMPS
- TV HORIZONTAL DEFLECTION

DESCRIPTION

Hollow emitter FASTSWITCH NPN power transistors have been especially designed for 220V (and 117V with input doubler) off-line switching power supply and colour CRT horizontal deflection appli-

cations. High voltage hollow emitter transistors can operate up to 50kHz with low cost drive circuits. These transistors can be used to advantage in off-line switching power supply applications where their high voltage rating is a benefit because a costly transformer clamp winding or over voltage snubbing can be omitted. These transistors are suitable for suitable for application in flyback and forward single transistor low power converters, 70W to 150W. When used in conjunction with a low voltage Power MOSFET in emitter switch configuration in flyback and forward converters, they can operate at up to 100kHz.

These hollow emitter FASTSWITCH transistors are available in TO-220, TO-218, ISOWATT220 and ISOWATT218 packages. The ISOWATT218 conforms to the creepage distance and isolation requirements of VDE, IEC, and UL specifications.

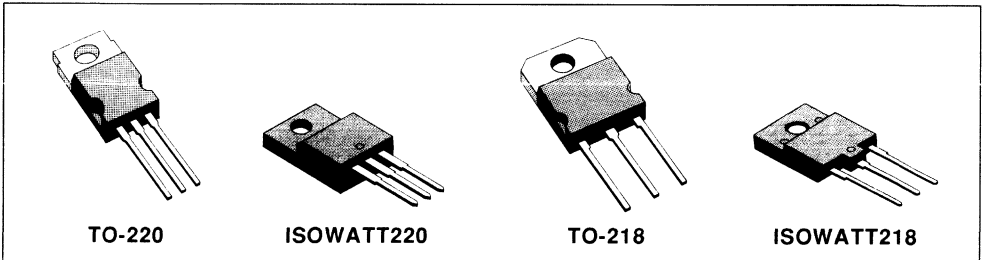

ABSOLUTE MAXIMUM RATINGS

Symbol	Parameter	SGS				Unit
		F324	IF324	F424	IF424	
V_{CES}	Collector - Emitter Voltage ($V_{BE} = 0$)	1200				V
V_{CEO}	Collector - Emitter Voltage ($I_B = 0$)	600				V
V_{EBO}	Emitter - Base Voltage ($I_C = 0$)	7				V
I_C	Collector Current	4				A
I_{CM}	Collector Peak Current ($t_p < 5ms$)	8				A
I_B	Base Current	3				A
I_{BM}	Base Peak Current ($t_p < 5ms$)	6				A
P_{Tot}	Total Dissipation at $T \leq 25^\circ C$	70	35	80	45	W
T_{stg}	Storage Temperature - 65 to	150	150	150	150	$^\circ C$
T_j	Junction Temperature	150	150	150	150	$^\circ C$

THERMAL DATA

			SGS				
			F324	IF324	F424	IF424	
$R_{thj-case}$	Thermal Resistance Junction-case	Max	1.78	3.57	1.56	2.78	°C/W

ELECTRICAL CHARACTERISTICS ($T_{case} = 25^{\circ}C$ unless otherwise specified)

Symbol	Parameter	Test Conditions	Min.	Typ.	Max.	Unit
I_{CES}	Collector Cutoff Current ($V_{BE} = 0$)	$V_{CE} = 1200V$			200	μA
I_{CEO}	Collector Cutoff Current ($I_B = 0$)	$V_{CE} = 380V$ $V_{CE} = 600V$			200 2	μA mA
I_{EBO}	Emitter Cutoff Current ($I_C = 0$)	$V_{EB} = 7V$			1	mA
$V_{CEO(sus)^*}$	Collector Emitter Sustaining Voltage	$I_C = 0.1A$	600			V
$V_{CE(sat)^*}$	Collector Emitter Saturation Voltage	$I_C = 1.75A$ $I_B = 0.35A$ $I_C = 1.25A$ $I_B = 0.18A$			1.5 1.5	V V
$V_{BE(sat)^*}$	Base Emitter Saturation Voltage	$I_C = 1.75A$ $I_B = 0.35A$ $I_C = 1.25A$ $I_B = 0.18A$			1.5 1.5	V V

RESISTIVE LOAD

Symbol	Parameter	Test Conditions	Min.	Typ.	Max.	Unit
t_{on}	Turn-on Time	$I_C = 1.75A$ $V_{CC} = 250V$ $I_{B1} = 0.35A$ $I_{B2} = -2I_{B1}$		0.6	1	μs
t_s	Storage Time			3	4.5	μs
t_f	Fall Time			0.2	0.35	μs
t_{on}	Turn-on Time	$I_C = 1.75A$ $V_{CC} = 250V$ $I_{B1} = 0.35A$ $I_{B2} = -2I_{B1}$ with Antisaturation Network		0.6		μs
t_s	Storage Time			2		μs
t_f	Fall Time			0.16		μs
t_{on}	Turn-on Time	$I_C = 1.75A$ $V_{CC} = 250V$ $I_{B1} = 0.35A$ $V_{BE(off)} = -5V$		0.6		μs
t_s	Storage Time			1		μs
t_f	Fall Time			0.5		μs

INDUCTIVE LOAD

Symbol	Parameter	Test Conditions	Min.	Typ.	Max.	Unit
t_s	Storage Time	$I_C = 1.75A$ $h_{FE} = 5$ $V_{CL} = 450V$ $V_{BE(off)} = -5V$ $L = 300\mu H$ $R_{B(off)} = 2\Omega$		1.2	2.5	μs
t_f	Fall Time			0.1	0.2	μs
t_s	Storage Time	$I_C = 1.75A$ $h_{FE} = 5$ $V_{CL} = 450V$ $V_{BE(off)} = -5V$ $L = 300\mu H$ $R_{B(off)} = 2\Omega$ $T_c = 100^{\circ}C$			3.7	μs
t_f	Fall Time				0.3	μs

* Pulsed : Pulse duration = 300 μs , duty cycle = 1.5%

Safe Operating Areas

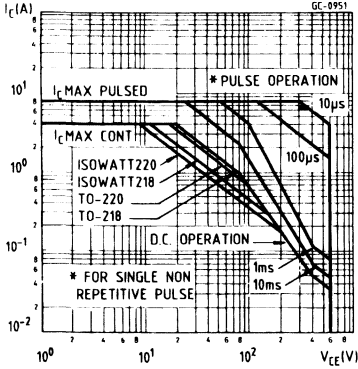

Reverse Biased Safe Operating Area

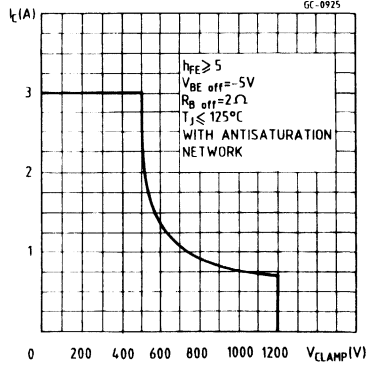

DC Current Gain

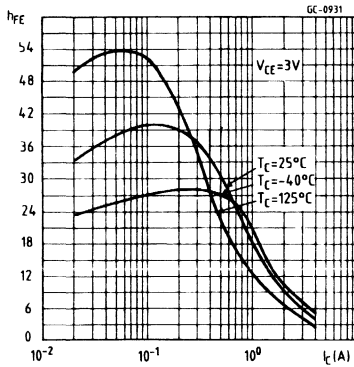

Collector-emitter Saturation Voltage

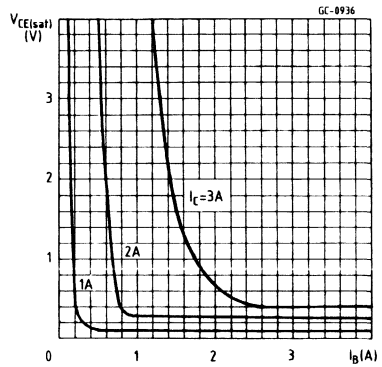

Collector-emitter Saturation Voltage

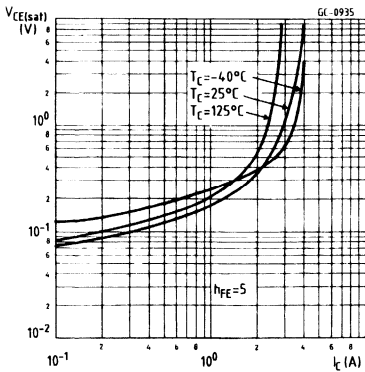

Base-emitter Saturation Voltage

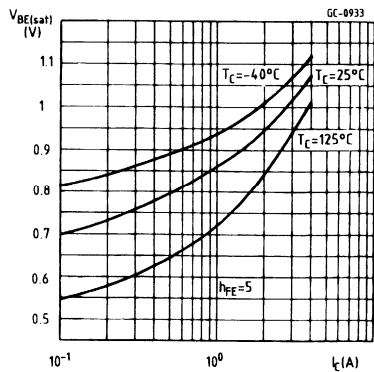

Resistive Load Switching Times

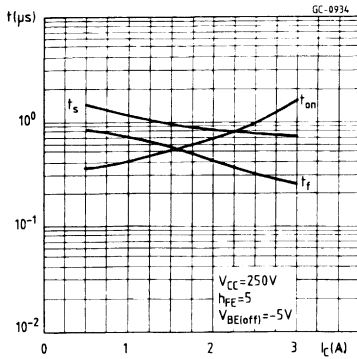

Inductive Load Switching Times

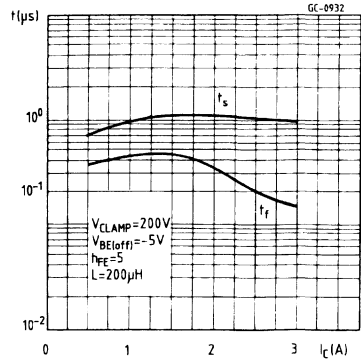

Switching Times Percentance Variation

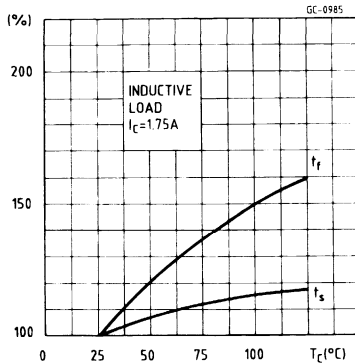

ISOWATT PACKAGES CHARACTERISTICS AND APPLICATION

The ISOWATT220 and ISOWATT218 are fully isolated packages. The ISOWATT220 is isolated to 2000V dc and the ISOWATT218 to 4000V dc. Their thermal impedance, given in the datasheet, is optimised to give efficient thermal conduction together with excellent electrical isolation.

The structure of the case ensures optimum distances between the pins and heatsink. For the ISOWATT218 these distances are in agreement with VDE and UL creepage and clearance standards. The ISOWATT218 is supplied with longer leads than the standard TO-218 to allow easy mounting on PCB's. The ISOWATT220 and ISOWATT218 packages eliminate the need for external isolation

so reducing fixing hardware. Accurate moulding techniques used in manufacture assures consistent heat spreader-to-heatsink capacitance.

The thermal performance of these packages is better than that of the standard part mounted with a 0.1mm mica washer. The thermally conductive plastic has a higher breakdown rating and is less fragile than mica or plastic sheets. Power derating for these ISOWATT packages is determined by :

$$P_D = \frac{T_j - T_c}{R_{th}}$$

THERMAL IMPEDANCE OF ISOWATT PACKAGES

Fig. 1 illustrates the elements contributing to the thermal resistance of a transistor heatsink assembly, using ISOWATT packages.

The total thermal resistance $R_{th(tot)}$ is the sum of each of these elements. The transient thermal impedance, Z_{th} for different pulse durations can be estimated as follows :

- 1 - For a short duration power pulse of less than 1ms :

$$Z_{th} < R_{thJ-C}$$

- 2 - For an intermediate power pulse of 5ms to 50ms seconds :

$$Z_{th} = R_{thJ-C}$$

- 3 - For long power pulses of the order of 500ms seconds or greater :

$$Z_{th} = R_{thJ-C} + R_{thC-HS} + R_{thHS-amb}$$

It is often possible to discern these areas on transient thermal impedance curves.

Figure 1.

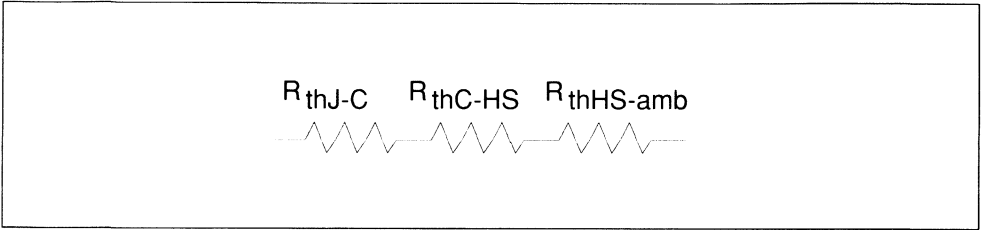

FASTSWITCH HOLLOW-EMITTER NPN TRANSISTORS

- HIGH SWITCHING SPEED NPN POWER TRANSISTORS
- HOLLOW EMITTER TECHNOLOGY
- HIGH VOLTAGE FOR OFF-LINE APPLICATIONS
- 50kHz SWITCHING SPEED
- LOW COST DRIVE CIRCUITS
- LOW DYNAMIC SATURATION

APPLICATIONS

- SMPS
- TV HORIZONTAL DEFLECTION

DESCRIPTION

Hollow emitter FASTSWITCH NPN power transistors are specially designed for 220V (and 117V with input doubler) off-line switching power supply and colour CRT deflection applications. High voltage

hollow emitter transistors can operate up to 50kHz with low cost drive circuits. These transistors can be used to advantage in off-line switching power supply applications where their high voltage rating is a benefit because costly transformer clamp windings or over voltage snubbing can be omitted. These transistors are suitable for application in flyback and forward single transistor low power converters, 50W to 100W. When used in conjunction with a Power MOSFET in emitter switch configuration in flyback and forward converters, they can operate at over 100kHz.

These hollow emitter FASTSWITCH transistors are available in TO-218 and fully isolated ISOWATT220 and ISOWATT218 packages. The ISOWATT218 conforms to the creepage distance and isolation requirements of VDE, IEC, and UL specifications.

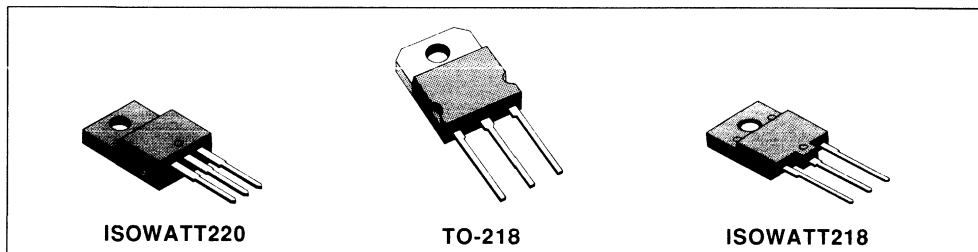

ABSOLUTE MAXIMUM RATINGS

Symbol	Parameter	SGS			Unit
		IF325	F425	IF425	
V_{CES}	Collector - Emitter Voltage ($V_{BE} = 0$)	1300			V
V_{CEO}	Collector - Emitter Voltage ($I_B = 0$)	600			V
V_{EBO}	Emitter - Base Voltage ($I_C = 0$)	7			V
I_C	Collector Current	4			A
I_{CM}	Collector Peak Current ($t_p < 5\text{ms}$)	8			A
I_B	Base Current	3			A
I_{BM}	Base Peak Current ($t_p < 5\text{ms}$)	6			A
P_{tot}	Total Dissipation at $T_c \leq 25^\circ\text{C}$	35	80	45	W
T_{stg}	Storage Temperature - 65 to	150	150	150	$^\circ\text{C}$
T_j	Junction Temperature	150	150	150	$^\circ\text{C}$

THERMAL DATA

			SGS			
			IF325	F425	IF425	
$R_{thj-case}$	Thermal Resistance Junction-case	Max	3.57	1.56	2.78	°C/W

ELECTRICAL CHARACTERISTICS ($T_{case} = 25^{\circ}C$ unless otherwise specified)

Symbol	Parameter	Test Conditions	Min.	Typ.	Max.	Unit
I_{CES}	Collector Cutoff Current ($V_{BE} = 0$)	$V_{CE} = 1300V$			200	μA
I_{CEO}	Collector Cutoff Current ($I_B = 0$)	$V_{CE} = 380V$ $V_{CE} = 600V$			200 2	μA mA
I_{EBO}	Emitter Cutoff Current ($I_C = 0$)	$V_{EB} = 7V$			1	mA
$V_{CEO(sus)^*}$	Collector Emitter Sustaining Voltage	$I_C = 0.1A$	600			V
$V_{CE(sat)^*}$	Collector Emitter Saturation Voltage	$I_C = 1.25A$ $I_B = 0.25A$ $I_C = 1A$ $I_B = 0.15A$			1.5 1.5	V V
$V_{BE(sat)^*}$	Base Emitter Saturation Voltage	$I_C = 1.25A$ $I_B = 0.25A$ $I_C = 1A$ $I_B = 0.15A$			1.5 1.5	V V

RESISTIVE LOAD

Symbol	Parameter	Test Conditions	Min.	Typ.	Max.	Unit
t_{on}	Turn-on Time	$I_C = 1.25A$ $V_{CC} = 250V$ $I_{B1} = 0.25A$ $I_{B2} = -2I_{B1}$		0.6	1	μs
t_s	Storage Time			3	4.5	μs
t_f	Fall Time			0.2	0.35	μs
t_{on}	Turn-on Time	$I_C = 1.25A$ $V_{CC} = 250V$ $I_{B1} = 0.25A$ $I_{B2} = -2I_{B1}$ With Antisaturation Network		0.6		μs
t_s	Storage Time			2		μs
t_f	Fall Time			0.16		μs
t_{on}	Turn-on Time	$I_C = 1.25A$ $V_{CC} = 250V$ $I_{B1} = 0.25A$ $V_{BE(off)} = -5V$		0.6		μs
t_s	Storage Time			1		μs
t_f	Fall Time			0.5		μs

INDUCTIVE LOAD

Symbol	Parameter	Test Conditions	Min.	Typ.	Max.	Unit
t_s	Storage Time	$I_C = 1.25A$ $h_{FE} = 5$ $V_{CL} = 450V$ $V_{BE(off)} = -5V$ $L = 300\mu H$ $R_{B(off)} = 2\Omega$		1.2	2.5	μs
t_f	Fall Time			0.1	0.2	μs
t_s	Storage Time	$I_C = 1.25A$ $h_{FE} = 5$ $V_{CL} = 450V$ $V_{BE(off)} = -5V$ $L = 300\mu H$ $R_{B(off)} = 2\Omega$ $T_C = 100^{\circ}C$			3.7	μs
t_f	Fall Time				0.3	μs

* Pulsed : Pulse duration = 300 μs , duty cycle = 1.5%

Safe Operating Areas

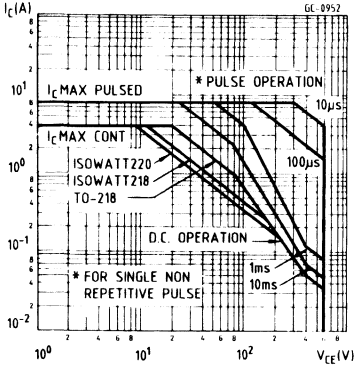

Reverse Biased Safe Operating Area

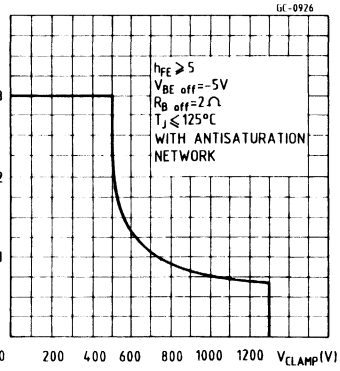

DC Current Gain

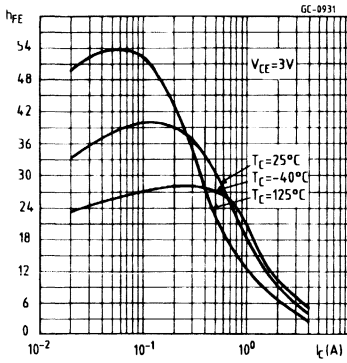

Collector-emitter Saturation Voltage

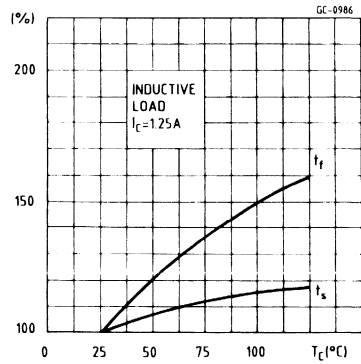

Collector-emitter Saturation Voltage

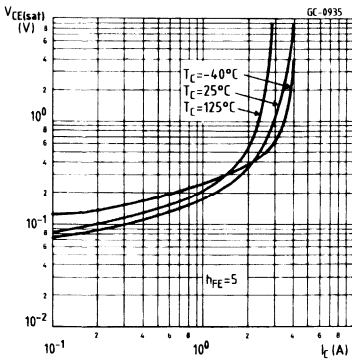

Base-emitter Saturation Voltage

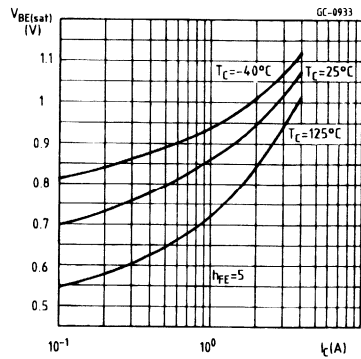

Resistive Load Switching Times

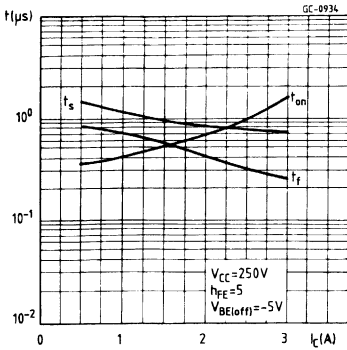

Inductive Load Switching Times

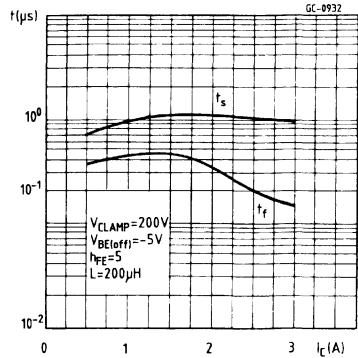

Switching Times Percentance Variation

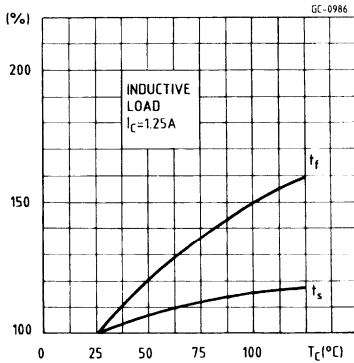

ISOWATT PACKAGES CHARACTERISTICS AND APPLICATION

The ISOWATT220 and ISOWATT218 are fully isolated packages. The ISOWATT220 is isolated to 2000V dc and the ISOWATT218 to 4000V dc. Their thermal impedance, given in the datasheet, is optimized to give efficient thermal conduction together with excellent electrical isolation.

The structure of the case ensures optimum distances between the pins and heatsink. For the ISOWATT218 these distances are in agreement with VDE and UL creepage and clearance standards. The ISOWATT218 is supplied with longer leads than the standard TO-218 to allow easy mounting on PCB's. The ISOWATT220 and ISOWATT218 packages eliminate the need for external isolation

so reducing fixing hardware. Accurate moulding techniques used in manufacture assures consistent heat spreader-to-heatsink capacitance.

The thermal performance of these packages is better than that of the standard part mounted with a 0.1mm mica washer. The thermally conductive plastic has a higher breakdown rating and is less fragile than mica or plastic sheets. Power derating for these ISOWATT packages is determined by :

$$P_D = \frac{T_j - T_c}{R_{th}}$$

THERMAL IMPEDANCE OF ISOWATT PACKAGES

Fig. 1 illustrates the elements contributing to the thermal resistance of a transistor heatsink assembly, using ISOWATT packages.

The total thermal resistance $R_{th(tot)}$ is the sum of each of these elements. The transient thermal impedance, Z_{th} for different pulse durations can be estimated as follows :

1 - For a short duration power pulse of less than 1ms :

$$Z_{th} < R_{thJ-C}$$

2 - For an intermediate power pulse of 5ms to 50ms seconds :

$$Z_{th} = R_{thJ-C}$$

3 - For long power pulses of the order of 500ms seconds or greater :

$$Z_{th} = R_{thJ-C} + R_{thC-HS} + R_{thHS-amb}$$

It is often possible to discern these areas on transient thermal impedance curves.

Figure 1.

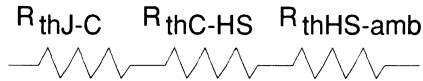

FASTSWITCH HOLLOW-EMITTER NPN TRANSISTORS

- HIGH SWITCHING SPEED NPN POWER TRANSISTORS
- HOLLOW EMITTER FOR FAST SWITCHING
- HIGH VOLTAGE FOR OFF-LINE APPLICATIONS
- 70kHz SWITCHING SPEED
- LOW COST DRIVE CIRCUITS
- LOW DYNAMIC SATURATION

APPLICATIONS

- SMPS

DESCRIPTION

Hollow emitter FASTSWITCH NPN power transistors have been specifically designed for 220V (and 117V with input doubler) off-line switching power

supply applications. Hollow emitter transistors can operate up to 70kHz with simple drive circuits which helps to simplify design and improve reliability. These transistors are suitable for applications in bridge and two transistor forward medium power converters, 450W to 900W. When used in conjunction with a low voltage Power MOSFET in emitter switch configuration in flyback and forward converters, they can operate at up to 100kHz.

These hollow emitter FASTSWITCH transistors are available in TO-220, TO-218, ISOWATT220 and ISOWATT218 packages. The ISOWATT218 conforms to the creepage distance and isolation requirements of VDE, IEC, and UL specifications. Additionally these FASTSWITCH transistors are available in metal TO-3 packages.

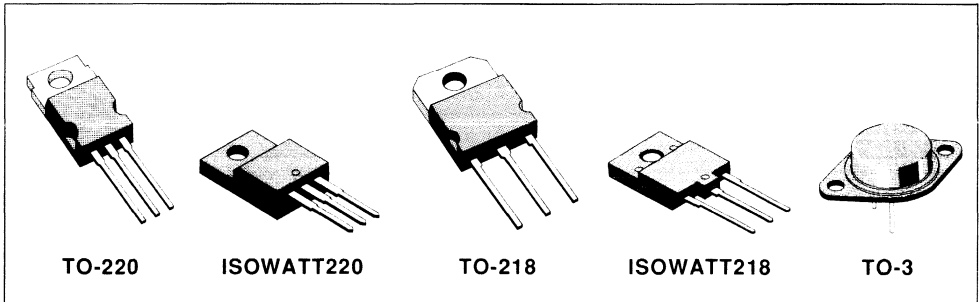

ABSOLUTE MAXIMUM RATINGS

Symbol	Parameter	SGS					Unit
		F341	IF341	F441	IF441	F541	
V_{CES}	Collector - Emitter Voltage ($V_{BE} = 0$)	850					V
V_{CEO}	Collector - Emitter Voltage ($I_B = 0$)	400					V
V_{EBO}	Emitter - Base Voltage ($I_C = 0$)	7					V
I_C	Collector Current	10					A
I_{CM}	Collector Peak Current ($t_p < 5ms$)	15					A
I_B	Base Current	6					A
I_{BM}	Base Peak Current ($t_p < 5ms$)	10					A
P_{tot}	Total Dissipation at $T_C \leq 25^\circ C$	85	40	95	55	115	W
T_{stg}	Storage Temperature - 65 to	150	150	150	150	175	$^\circ C$
T_J	Junction Temperature	150	150	150	150	175	$^\circ C$

THERMAL DATA

			SGS					
			F341	IF341	F441	IF441	F541	
R _{thj-case}	Thermal Resistance Junction-case	Max	1.47	3.12	1.31	2.27	1.3	°C/W

ELECTRICAL CHARACTERISTICS (T_{case} = 25°C unless otherwise specified)

Symbol	Parameter	Test Conditions	Min.	Typ.	Max.	Unit
I _{CEs}	Collector Cutoff Current (V _{BE} = 0)	V _{CE} = 850V			200	µA
I _{CE0}	Collector Cutoff Current (I _B = 0)	V _{CE} = 380V V _{CE} = 400V			200 2	µA mA
I _{EBO}	Emitter Cutoff Current (I _C = 0)	V _{EB} = 7V			1	mA
V _{CEO(sus)*}	Collector Emitter Sustaining Voltage	I _C = 0.1A	400			V
V _{CE(sat)*}	Collector Emitter Saturation Voltage	I _C = 6A I _C = 4A	I _B = 1.2A I _B = 0.6A		1.5 1.5	V V
V _{BE(sat)*}	Base Emitter Saturation Voltage	I _C = 6A I _C = 4A	I _B = 1.2A I _B = 0.6A		1.5 1.5	V V

RESISTIVE LOAD

Symbol	Parameter	Test Conditions	Min.	Typ.	Max.	Unit		
t _{on}	Turn-on Time	I _C = 6A I _{B1} = 1.2A		V _{CC} = 250V I _{B2} = -2I _{B1}		µs		
t _s	Storage Time						0.5	1
t _f	Fall Time						1.6	2.5
t _{on}	Turn-on Time	I _C = 6A I _{B1} = 1.2A		V _{CC} = 250V I _{B2} = -2I _{B1} with Antisaturation Network		µs		
t _s	Storage Time						0.25	0.35
t _f	Fall Time						0.5	
t _{on}	Turn-on Time	I _C = 6A I _{B1} = 1.2A		V _{CC} = 250V V _{BE(off)} = -5V		µs		
t _s	Storage Time						0.5	
t _f	Fall Time						1.1	
t _{on}	Turn-on Time	I _C = 6A I _{B1} = 1.2A		V _{CC} = 250V V _{BE(off)} = -5V		µs		
t _s	Storage Time						0.2	
t _f	Fall Time						0.5	
t _{on}	Turn-on Time	I _C = 6A I _{B1} = 1.2A		V _{CC} = 250V V _{BE(off)} = -5V		µs		
t _s	Storage Time						0.5	
t _f	Fall Time						1.4	
t _{on}	Turn-on Time	I _C = 6A I _{B1} = 1.2A		V _{CC} = 250V V _{BE(off)} = -5V		µs		
t _s	Storage Time						0.1	
t _f	Fall Time						0.1	

INDUCTIVE LOAD

Symbol	Parameter	Test Conditions	Min.	Typ.	Max.	Unit
t _s	Storage Time	I _C = 6A V _{CL} = 350V L = 300µH	h _{FE} = 5 V _{BE(off)} = -5V			µs
t _f	Fall Time					
t _s	Storage Time	I _C = 6A V _{CL} = 350V L = 300µH T _c = 100°C	h _{FE} = 5 V _{BE(off)} = -5V			µs
t _f	Fall Time					

* Pulsed : Pulse duration = 300µs, duty cycle = 1.5%

Safe Operating Areas

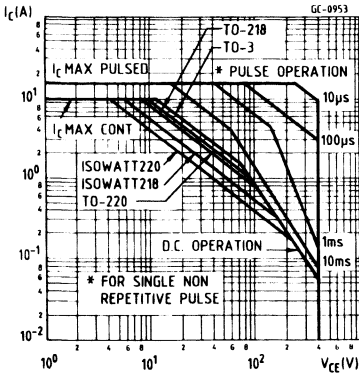

Reverse Biased Safe Operating Area

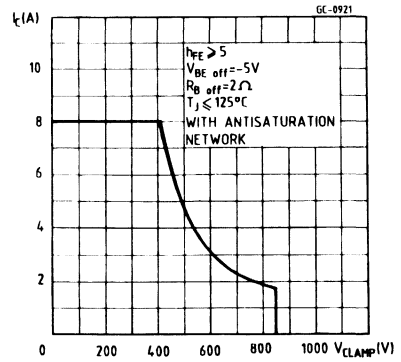

DC Current Gain

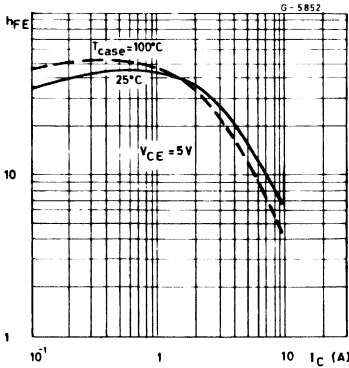

Collector-emitter Saturation Voltage

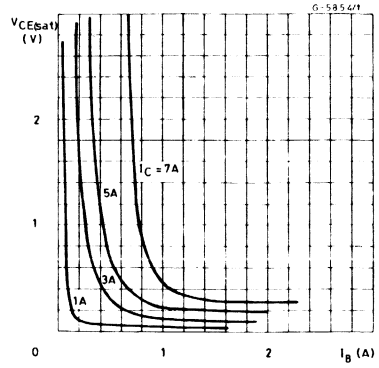

Collector-emitter Saturation Voltage

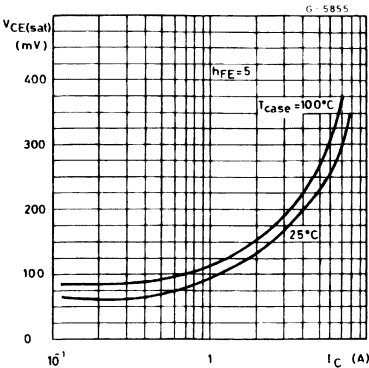

Base-emitter Saturation Voltage

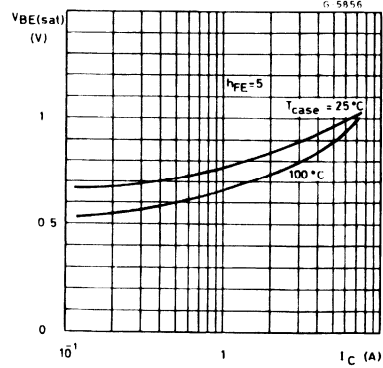

Resistive Load Switching Times

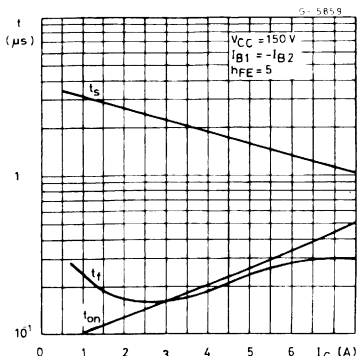

Inductive Load Switching Times

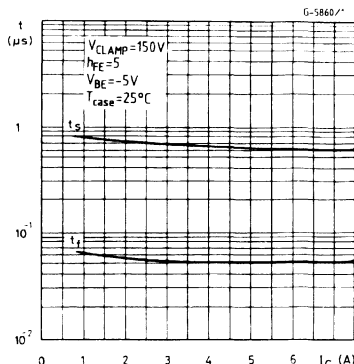

Switching Times Percentage Variation

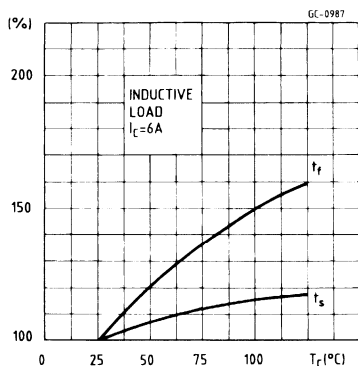

ISOWATT PACKAGES CHARACTERISTICS AND APPLICATION

The ISOWATT220 and ISOWATT218 are fully isolated packages. The ISOWATT220 is isolated to 2000V dc and the ISOWATT218 to 4000V dc. Their thermal impedance, given in the datasheet, is optimised to give efficient thermal conduction together with excellent electrical isolation.

The structure of the case ensures optimum distances between the pins and heatsink. For the ISOWATT218 these distances are in agreement with VDE and UL creepage and clearance standards. The ISOWATT218 is supplied with longer leads than the standard TO-218 to allow easy mounting on PCB's. The ISOWATT220 and ISOWATT218 packages eliminate the need for external isolation

so reducing fixing hardware. Accurate moulding techniques used in manufacture assures consistent heat spreader-to-heatsink capacitance.

The thermal performance of these packages is better than that of the standard part mounted with a 0.1mm mica washer. The thermally conductive plastic has a higher breakdown rating and is less fragile than mica or plastic sheets. Power derating for these ISOWATT packages is determined by :

$$P_D = \frac{T_j - T_c}{R_{th}}$$

THERMAL IMPEDANCE OF ISOWATT PACKAGES

Fig. 1 illustrates the elements contributing to the thermal resistance of a transistor heatsink assembly, using ISOWATT packages.

The total thermal resistance $R_{th(tot)}$ is the sum of each of these elements. The transient thermal impedance, Z_{th} for different pulse durations can be estimated as follows :

1 - For a short duration power pulse of less than 1ms :

$$Z_{th} < R_{thJ-C}$$

2 - For an intermediate power pulse of 5ms to 50ms seconds :

$$Z_{th} = R_{thJ-C}$$

3 - For long power pulses of the order of 500ms seconds or greater :

$$Z_{th} = R_{thJ-C} + R_{thC-HS} + R_{thHS-amb}$$

It is often possible to discern these areas on transient thermal impedance curves.

Figure 1.

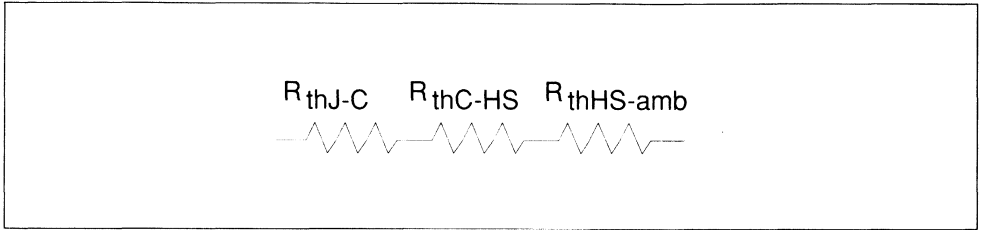



FASTSWITCH HOLLOW-EMITTER NPN TRANSISTORS

- HIGH SWITCHING SPEED NPN POWER TRANSISTORS
- HOLLOW EMITTER TECHNOLOGY
- HIGH VOLTAGE FOR OFF-LINE APPLICATIONS
- 70kHz SWITCHING SPEED
- LOW COST DRIVE CIRCUITS
- LOW DYNAMIC SATURATION

operate up to 70kHz with snubber drive circuits which helps to simplify designs and improve reliability. The high voltage rating of these transistors allows simplification of the over voltage snubbing network. These transistors are suitable for application in half bridge and full bridge medium power converters, 350W to 700W. When used in conjunction with a low voltage Power MOSFET in emitter switch configuration they can operate at up to 100kHz.

APPLICATIONS

- SMPS

DESCRIPTION

Hollow emitter FASTSWITCH NPN power transistors have been specifically designed for 220V (and 117V with input doubler) off-line switching power supply applications. Hollow emitter transistors can

These hollow emitter FASTSWITCH transistors are available in TO-220, TO-218, ISOWATT220 and ISOWATT218 packages. The ISOWATT218 conforms to the creepage distance and isolation requirements of VDE, IEC, and UL specifications. Additionally these FASTSWITCH transistors are available in metal TO-3 packages.

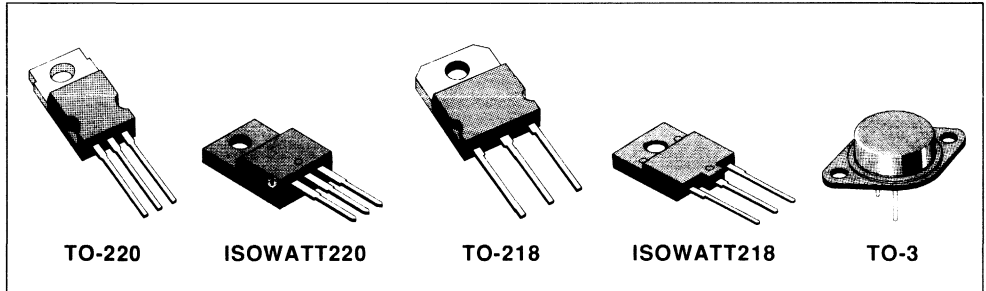

ABSOLUTE MAXIMUM RATINGS

Symbol	Parameter	SGS					Unit
		F343	IF343	F443	IF443	F543	
V_{CES}	Collector - Emitter Voltage ($V_{BE} = 0$)	1000					V
V_{CEO}	Collector - Emitter Voltage ($I_B = 0$)	450					V
V_{EBO}	Emitter - Base Voltage ($I_C = 0$)	7					V
I_C	Collector Current	8					A
I_{CM}	Collector Peak Current ($t_p < 5ms$)	15					A
I_B	Base Current	5					A
I_{BM}	Base Peak Current ($t_p < 5ms$)	8					A
P_{tot}	Total Dissipation at $T_c \leq 25^\circ C$	85	40	95	55	115	W
T_{stg}	Storage Temperature - 65 to	150	150	150	150	175	$^\circ C$
T_j	Junction Temperature	150	150	150	150	175	$^\circ C$

THERMAL DATA

		Max	SGS					°C/W
			F343	IF343	F443	IF443	F453	
R _{thj-case}	Thermal Resistance Junction-case		1.47	3.12	1.31	2.27	1.3	

ELECTRICAL CHARACTERISTICS (T_{case} = 25°C unless otherwise specified)

Symbol	Parameter	Test Conditions	Min.	Typ.	Max.	Unit
I _{CES}	Collector Cutoff Current (V _{BE} = 0)	V _{CE} = 1000V			200	µA
I _{CEO}	Collector Cutoff Current (I _B = 0)	V _{CE} = 380V V _{CE} = 450V			200 2	µA mA
I _{EBO}	Emitter Cutoff Current (I _C = 0)	V _{EB} = 7V			1	mA
V _{CEO(sus)*}	Collector Emitter Sustaining Voltage	I _C = 0.1A	450			V
V _{CE(sat)*}	Collector Emitter Saturation Voltage	I _C = 4.5A I _B = 0.9A I _C = 3A I _B = 0.45A			1.5 1.5	V V
V _{BE(sat)*}	Base Emitter Saturation Voltage	I _C = 4.5A I _B = 0.9A I _C = 3A I _B = 0.45A			1.5 1.5	V V

RESISTIVE LOAD

Symbol	Parameter	Test Conditions	Min.	Typ.	Max.	Unit
t _{on}	Turn-on Time	I _C = 4.5A V _{CC} = 250V I _{B1} = 0.9A I _{B2} = - 2 I _{B1}		0.5	1	µs
t _s	Storage Time			1.6	2.5	µs
t _f	Fall Time			0.25	0.35	µs
t _{on}	Turn-on Time	I _C = 4.5A V _{CC} = 250V I _{B1} = 0.9A I _{B2} = - 2 I _{B1} With Antisaturation Network		0.5		µs
t _s	Storage Time			1.1		µs
t _f	Fall Time			0.2		µs
t _{on}	Turn-on Time	I _C = 4.5A V _{CC} = 250V I _{B1} = 0.9A V _{BE(off)} = - 5V		0.5		µs
t _s	Storage Time			1.4		µs
t _f	Fall Time			0.1		µs

INDUCTIVE LOAD

Symbol	Parameter	Test Conditions	Min.	Typ.	Max.	Unit
t _s	Storage Time	I _C = 4.5A h _{FE} = 5 V _{CL} = 350V V _{BE(off)} = - 5V L = 300µH R _{B(off)} = 1.2Ω		1.4	2.8	µs
t _f	Fall Time			0.1	0.2	µs
t _s	Storage Time	I _C = 4.5A h _{FE} = 5 V _{CL} = 350V V _{BE(off)} = - 5V L = 300µH R _{B(off)} = 1.2Ω T _C = 100°C			4	µs
t _f	Fall Time				0.3	µs

* Pulsed : Pulse duration = 300µs, duty cycle = 1.5%

Safe Operating Areas

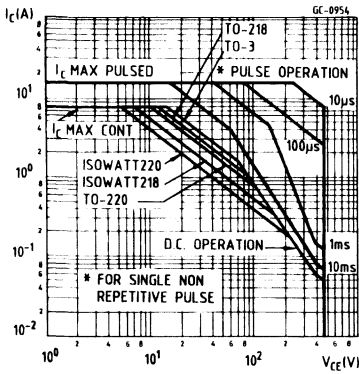

Reverse Biased Safe Operating Area

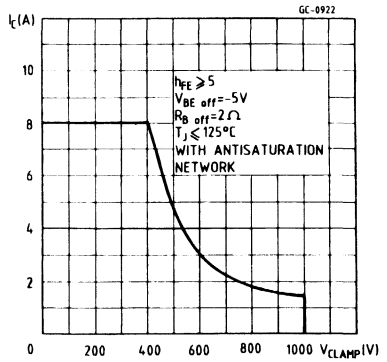

DC Current Gain

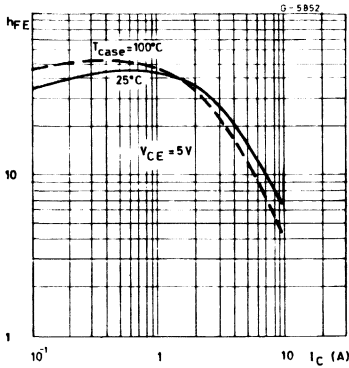

Collector-emitter Saturation Voltage

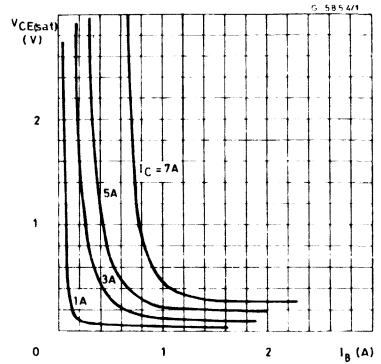

Collector-emitter Saturation Voltage

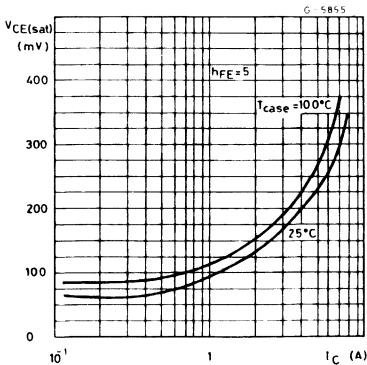

Base-emitter Saturation Voltage

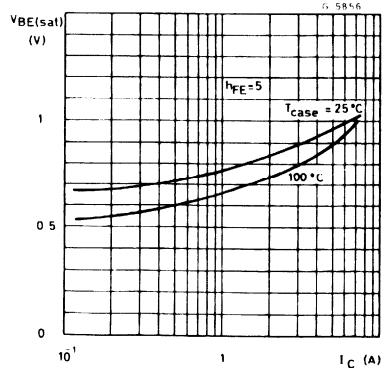

Resistive Load Switching Times

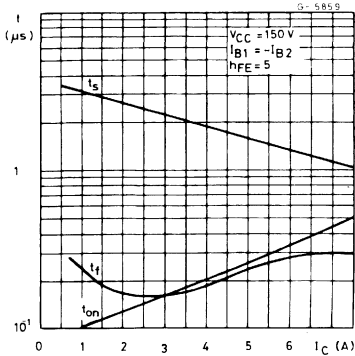

Inductive Load Switching Times

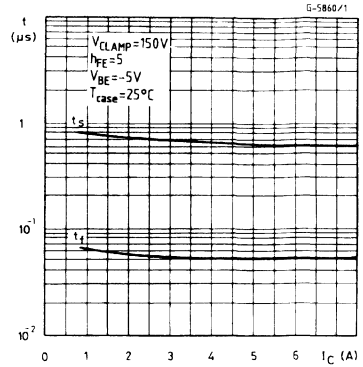

Switching Times Percentage Variation

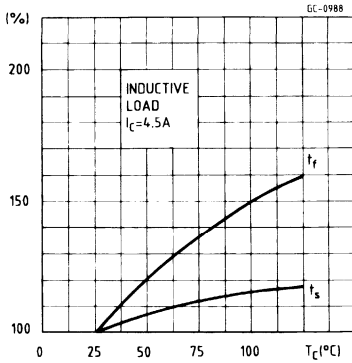

ISOWATT PACKAGES CHARACTERISTICS AND APPLICATION

The ISOWATT220 and ISOWATT218 are fully isolated packages. The ISOWATT220 is isolated to 2000V dc and the ISOWATT218 to 4000V dc. Their thermal impedance, given in the datasheet, is optimised to give efficient thermal conduction together with excellent electrical isolation.

The structure of the case ensures optimum distances between the pins and heatsink. For the ISOWATT218 these distances are in agreement with VDE and UL creepage and clearance standards. The ISOWATT218 is supplied with longer leads than the standard TO-218 to allow easy mounting on PCB's. The ISOWATT220 and ISOWATT218 packages eliminate the need for external isolation

so reducing fixing hardware. Accurate moulding techniques used in manufacture assures consistent heat spreader-to-heatsink capacitance.

The thermal performance of these packages is better than that of the standard part mounted with a 0.1mm mica washer. The thermally conductive plastic has a higher breakdown rating and is less fragile than mica or plastic sheets. Power derating for these ISOWATT packages is determined by :

$$P_D = \frac{T_j - T_c}{R_{th}}$$

THERMAL IMPEDANCE OF ISOWATT PACKAGES

Fig. 1 illustrates the elements contributing to the thermal resistance of a transistor heatsink assembly, using ISOWATT packages.

The total thermal resistance $R_{th(tot)}$ is the sum of each of these elements. The transient thermal impedance, Z_{th} for different pulse durations can be estimated as follows :

- 1 - For a short duration power pulse of less than 1 ms :

$$Z_{th} < R_{thJ-C}$$

- 2- For an intermediate power pulse of 5ms to 50ms seconds :

$$Z_{th} = R_{thJ-C}$$

- 3- For long power pulses of the order of 500ms seconds or greater :

$$Z_{th} = R_{thJ-C} + R_{thC-HS} + R_{thHS-amb}$$

It is often possible to discern these areas on transient thermal impedance curves.

Figure 1.

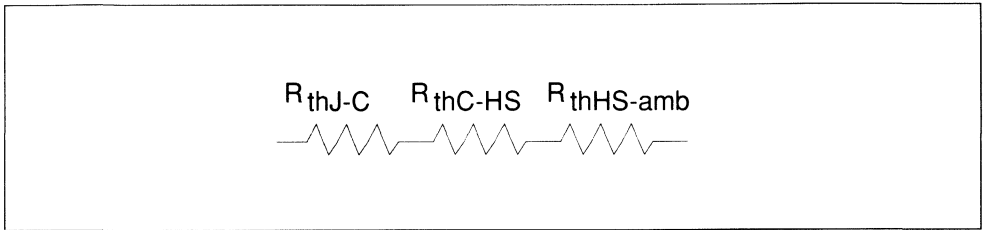

FASTSWITCH HOLLOW-EMITTER NPN TRANSISTORS

- HIGH SWITCHING SPEED NPN POWER TRANSISTORS
- HOLLOW EMITTER TECHNOLOGY
- HIGH VOLTAGE FOR OFF-LINE APPLICATIONS
- 50kHz SWITCHING SPEED
- LOW COST DRIVE CIRCUITS
- LOW DYNAMIC SATURATION

APPLICATIONS

- SMPS
- TV HORIZONTAL DEFLECTION

DESCRIPTION

Hollow emitter FASTSWITCH NPN power transistors are specially designed for 220V (and 117V with input doubler) off-line switching power supply and colour CRT deflection applications. Hollow emitter

transistors can operate up to 50kHz with simple drive circuits which helps to simplify design and improve reliability. These transistors are suitable for application in flyback and forward low power converters, 140W to 250W. The high voltage rating of hollow emitter transistors can be used to advantage because a costly transformer clamp winding or over voltage snubbers can be omitted. When used in conjunction with a low voltage Power MOSFET in emitter switch configuration in flyback and forward converters, they can operate at up to 100kHz.

These hollow emitter FASTSWITCH transistors are available in TO-220, TO-218, ISOWATT220 and ISOWATT218 packages. The ISOWATT218 conforms to the creepage distance and isolation requirements of VDE, IEC, and UL specifications. Additionally these FASTSWITCH transistors are available in metal TO-3 packages.

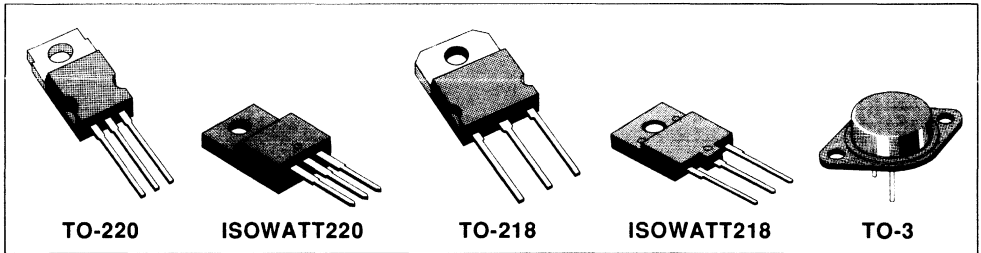

ABSOLUTE MAXIMUM RATINGS

Symbol	Parameter	SGS					Unit
		F344	IF344	F444	IF444	F544	
V_{CES}	Collector - Emitter Voltage ($V_{BE} = 0$)	1200					V
V_{CEO}	Collector - Emitter Voltage ($I_B = 0$)	600					V
V_{EBO}	Emitter - Base Voltage ($I_C = 0$)	7					V
I_C	Collector Current	7					A
I_{CM}	Collector Peak Current ($t_p < 5ms$)	12					A
I_B	Base Current	5					A
I_{BM}	Base Peak Current ($t_p < 5ms$)	8					A
P_{tot}	Total Dissipation at $T_c \leq 25^\circ C$	85	40	95	55	115	W
T_{stg}	Storage Temperature - 65 to	150	150	150	150	175	$^\circ C$
T_j	Junction Temperature	150	150	150	150	175	$^\circ C$

THERMAL DATA

			SGS					
			F344	IF344	F444	IF444	F544	
R _{thj-case}	Thermal Resistance Junction-case	Max	1.47	3.12	1.31	2.27	1.3	°C/W

ELECTRICAL CHARACTERISTICS (T_{case} = 25°C unless otherwise specified)

Symbol	Parameter	Test Conditions	Min.	Typ.	Max.	Unit
I _{CES}	Collector Cutoff Current (V _{BE} = 0)	V _{CE} = 1200V			200	μA
I _{CEO}	Collector Cutoff Current (I _B = 0)	V _{CE} = 380V V _{CE} = 600V			200 2	μA mA
I _{EBO}	Emitter Cutoff Current (I _C = 0)	V _{EB} = 7V			1	mA
V _{CEO(sus)*}	Collector Emitter Sustaining Voltage	I _C = 0.1A	600			V
V _{CE(sat)*}	Collector Emitter Saturation Voltage	I _C = 3.5A I _B = 0.7A I _C = 2.5A I _B = 0.35A			1.5 1.5	V V
V _{BE(sat)*}	Base Emitter Saturation Voltage	I _C = 3.5A I _B = 0.7A I _C = 2.5A I _B = 0.35A			1.5 1.5	V V

RESISTIVE LOAD

Symbol	Parameter	Test Conditions	Min.	Typ.	Max.	Unit
t _{on}	Turn-on Time	I _C = 3.5A V _{CC} = 250V I _{B1} = 0.7A I _{B2} = -2I _{B1}		0.7	1.2	μs
t _s	Storage Time			2.2	3.5	μs
t _f	Fall Time			0.18	0.3	μs
t _{on}	Turn-on Time	I _C = 3.5A V _{CC} = 250V I _{B1} = 0.7A I _{B2} = -2I _{B1} with Antisaturation Network		0.7		μs
t _s	Storage Time			1.5		μs
t _f	Fall Time			0.2		μs
t _{on}	Turn-on Time	I _C = 3.5A V _{CC} = 250V I _{B1} = 0.7A V _{BE(off)} = -5V		0.7		μs
t _s	Storage Time			1		μs
t _f	Fall Time			0.2		μs

INDUCTIVE LOAD

Symbol	Parameter	Test Conditions	Min.	Typ.	Max.	Unit
t _s	Storage Time	I _C = 3.5A h _{FE} = 5 V _{CL} = 450V V _{BE(off)} = -5V L = 300μH R _{B(off)} = 1.2Ω		1.4	2.8	μs
t _f	Fall Time			0.1	0.2	μs
t _s	Storage Time	I _C = 3.5A h _{FE} = 5 V _{CL} = 450V V _{BE(off)} = -5V L = 300μH R _{B(off)} = 1.2Ω T _C = 100°C			4	μs
t _f	Fall Time				0.3	μs

* Pulsed : Pulse duration = 300μs, duty cycle = 1.5%

Safe Operating Areas

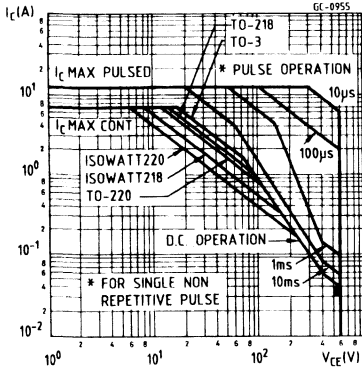

Reverse Biased Safe Operating Area

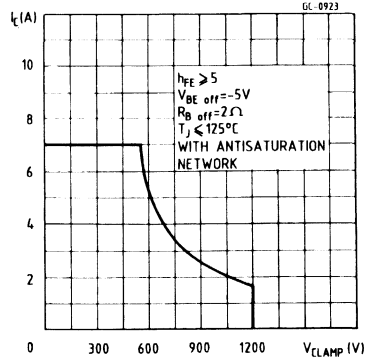

DC Current Gain

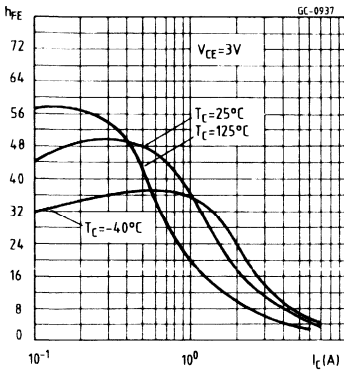

Collector-emitter Saturation Voltage

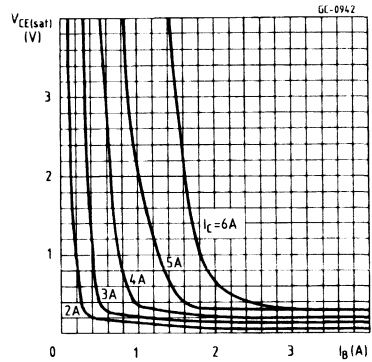

Collector-emitter Saturation Voltage

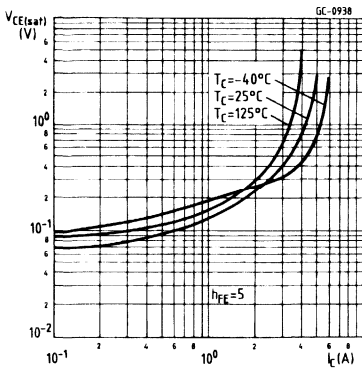

Base-emitter Saturation Voltage

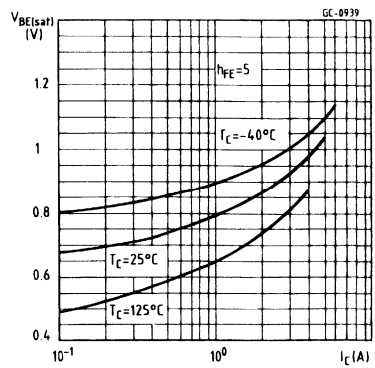

Resistive Load Switching Times

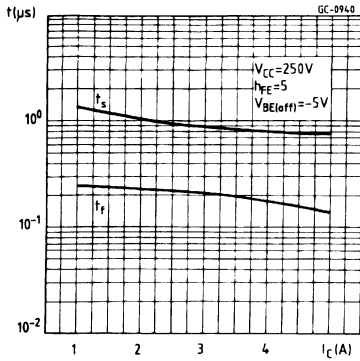

Inductive Load Switching Times

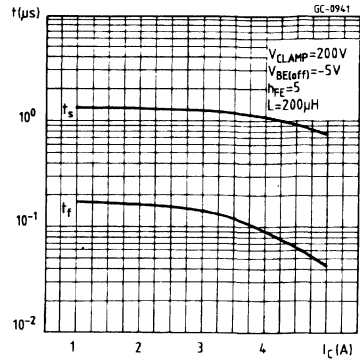

Switching Times Percentance Variation

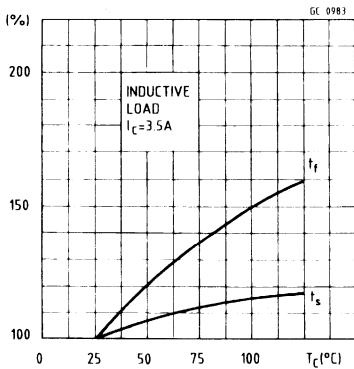

ISOWATT PACKAGES CHARACTERISTICS AND APPLICATION

The ISOWATT220 and ISOWATT218 are fully isolated packages. The ISOWATT220 is isolated to 2000V dc and the ISOWATT218 to 4000V dc. Their thermal impedance, given in the datasheet, is optimised to give efficient thermal conduction together with excellent electrical isolation.

The structure of the case ensures optimum distances between the pins and heatsink. For the ISOWATT218 these distances are in agreement with VDE and UL creepage and clearance standards. The ISOWATT218 is supplied with longer leads than the standard TO-218 to allow easy mounting on PCB's. The ISOWATT220 and ISOWATT218 packages eliminate the need for external isolation

so reducing fixing hardware. Accurate moulding techniques used in manufacture assures consistent heat spreader-to-heatsink capacitance.

The thermal performance of these packages is better than that of the standard part mounted with a 0.1mm mica washer. The thermally conductive plastic has a higher breakdown rating and is less fragile than mica or plastic sheets. Power derating for these ISOWATT packages is determined by :

$$P_D = \frac{T_j - T_c}{R_{th}}$$

THERMAL IMPEDANCE OF ISOWATT PACKAGES

Fig. 1 illustrates the elements contributing to the thermal resistance of a transistor heatsink assembly, using ISOWATT packages.

The total thermal resistance $R_{th(tot)}$ is the sum of each of these elements. The transient thermal impedance, Z_{th} for different pulse durations can be estimated as follows :

- 1 - For a short duration power pulse of less than 1 ms :

$$Z_{th} < R_{thJ-C}$$

- 2 - For an intermediate power pulse of 5ms to 50ms seconds :

$$Z_{th} = R_{thJ-C}$$

- 3 - For long power pulses of the order of 500ms seconds or greater :

$$Z_{th} = R_{thJ-C} + R_{thC-HS} + R_{thHS-amb}$$

It is often possible to discern these areas on transient thermal impedance curves.

Figure 1.

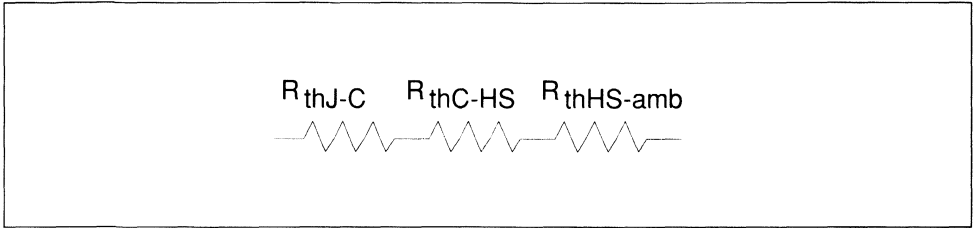

FASTSWITCH HOLLOW-EMITTER NPN TRANSISTORS

- HIGH SWITCHING SPEED NPN POWER TRANSISTORS
- HOLLOW EMITTER TECHNOLOGY
- HIGH VOLTAGE FOR OFF-LINE APPLICATIONS
- 50kHz SWITCHING SPEED
- LOW COST DRIVE CIRCUITS
- LOW DYNAMIC SATURATION

APPLICATIONS

- SMPS
- TV HORIZONTAL DEFLECTION

DESCRIPTION

Hollow emitter FASTSWITCH NPN power transistors are specially designed for 220V (and 117V with input doubler) off-line switching power supply and colour CRT deflection applications. High voltage

hollow emitter transistors can operate up to 50kHz with simple drive circuits which helps to simplify design and improve reliability. These transistors are suitable for application in flyback and forward low power converters, 120W to 240W. Their high voltage rating can be used to advantage as it allows a costly transformer clamp winding or over voltage snubbers to be omitted. When used in conjunction with a low Power MOSFET in emitter switch configuration, they can operate at over 100kHz.

These hollow emitter FASTSWITCH transistors are available in TO-218, and fully isolated ISOWATT220 and ISOWATT218 packages. The ISOWATT218 conforms to the creepage distance and isolation requirements of VDE, IEC, and UL specifications. Additionally these FASTSWITCH transistors are available in metal TO-3 packages.

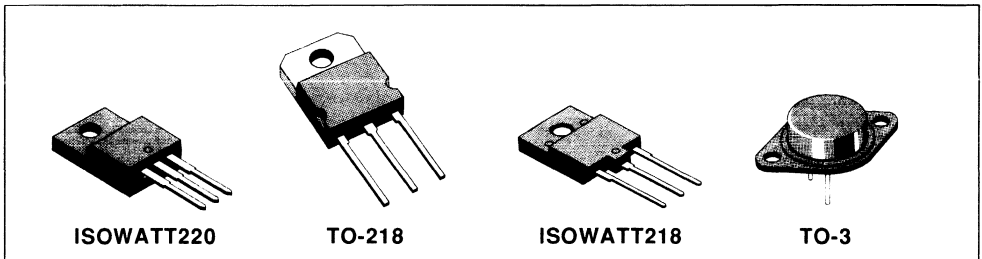

ABSOLUTE MAXIMUM RATINGS

Symbol	Parameter	SGS				Unit
		IF345	F445	IF445	F545	
V_{CES}	Collector - Emitter Voltage ($V_{BE} = 0$)	1300				V
V_{CEO}	Collector - Emitter Voltage ($I_B = 0$)	600				V
V_{EBO}	Emitter - Base Voltage ($I_C = 0$)	7				V
I_C	Collector Current	7				A
I_{CM}	Collector Peak Current ($t_p < 5ms$)	12				A
I_B	Base Current	5				A
I_{BM}	Base Peak Current ($t_p < 5ms$)	8				A
P_{tot}	Total Dissipation at $T_c \leq 25^\circ C$	40	95	55	115	W
T_{stg}	Storage Temperature - 65 to	150	150	150	175	$^\circ C$
T_j	Junction Temperature	150	150	150	175	$^\circ C$

THERMAL DATA

		Max	SGS				°C/W
			IF345	F445	IF445	F545	
R _{thj-case}	Thermal Resistance Junction-case		3.12	1.31	2.27	1.3	

ELECTRICAL CHARACTERISTICS (T_{case} = 25°C unless otherwise specified)

Symbol	Parameter	Test Conditions	Min.	Typ.	Max.	Unit
I _{CES}	Collector Cutoff Current (V _{BE} = 0)	V _{CE} = 1300V			200	μA
I _{CEO}	Collector Cutoff Current (I _B = 0)	V _{CE} = 380V V _{CE} = 600V			200 2	μA mA
I _{EBO}	Emitter Cutoff Current (I _C = 0)	V _{EB} = 7V			1	mA
V _{CEO(sus)*}	Collector Emitter Sustaining Voltage	I _C = 0.1A	600			V
V _{CE(sat)*}	Collector Emitter Saturation Voltage	I _C = 3A I _B = 0.6A I _C = 2A I _B = 0.3A			1.5 1.5	V V
V _{BE(sat)*}	Base Emitter Saturation Voltage	I _C = 3A I _B = 0.6A I _C = 2A I _B = 0.3A			1.5 1.5	V V

RESISTIVE LOAD

Symbol	Parameter	Test Conditions	Min.	Typ.	Max.	Unit
t _{on}	Turn-on Time	I _C = 3A V _{CC} = 250V I _{B1} = 0.6A I _{B2} = -2I _{B1}		0.7	1.2	μs
t _s	Storage Time			2.2	3.5	μs
t _f	Fall Time			0.18	0.3	μs
t _{on}	Turn-on Time	I _C = 3A V _{CC} = 250V I _{B1} = 0.6A I _{B2} = -2I _{B1} With Antisaturation Network		0.7		μs
t _s	Storage Time			1.5		μs
t _f	Fall Time			0.2		μs
t _{on}	Turn-on Time	I _C = 3A V _{CC} = 250V I _{B1} = 0.6A V _{BE(off)} = -5V		0.7		μs
t _s	Storage Time			1		μs
t _f	Fall Time			0.2		μs

INDUCTIVE LOAD

Symbol	Parameter	Test Conditions	Min.	Typ.	Max.	Unit
t _s	Storage Time	I _C = 3A h _{FE} = 5 V _{CL} = 450V V _{BE(off)} = -5V L = 300μH R _{B(off)} = 1.2Ω		1.4	2.8	μs
t _f	Fall Time			0.1	0.2	μs
t _s	Storage Time	I _C = 3A h _{FE} = 5 V _{CL} = 450V V _{BE(off)} = -5V L = 300μH R _{B(off)} = 1.2Ω T _c = 100°C			4	μs
t _f	Fall Time				0.3	μs

* Pulsed : Pulse duration = 300μs, duty cycle = 1.5%

Safe Operating Areas

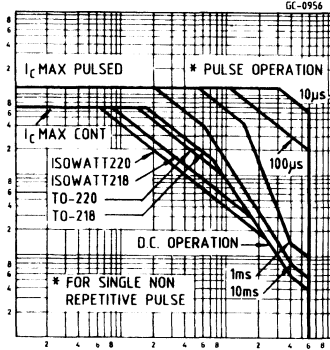

Reverse Biased Safe Operating Area

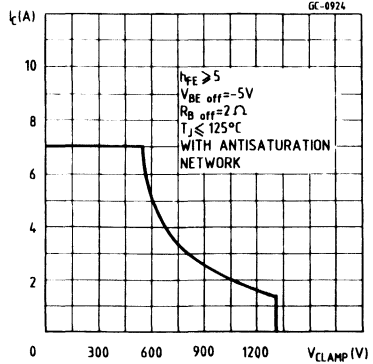

DC Current Gain

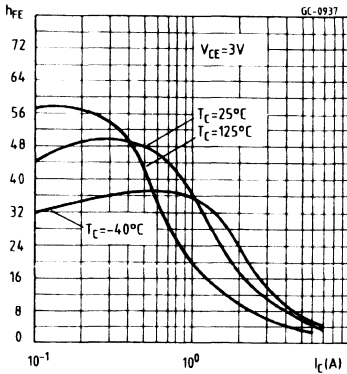

Collector-emitter Saturation Voltage

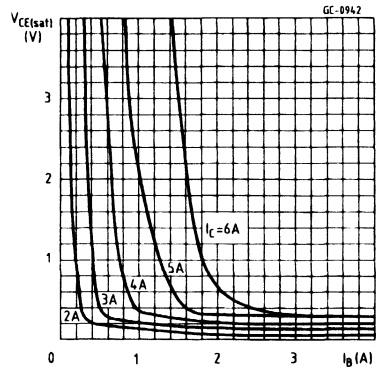

Collector-emitter Saturation Voltage

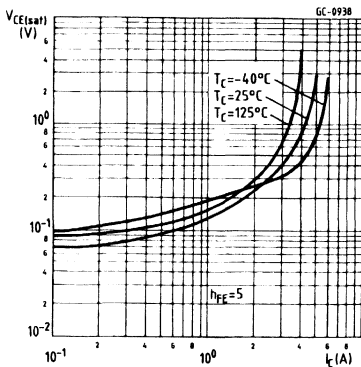

Base-emitter Saturation Voltage

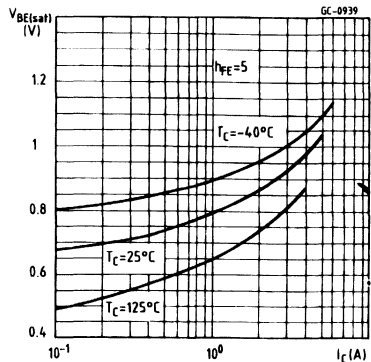

Resistive Load Switching Times

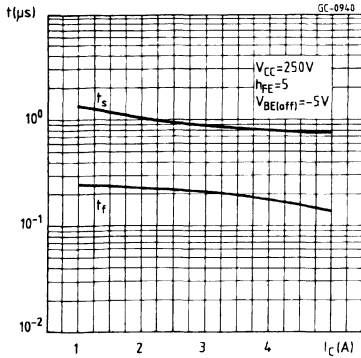

Inductive Load Switching Times

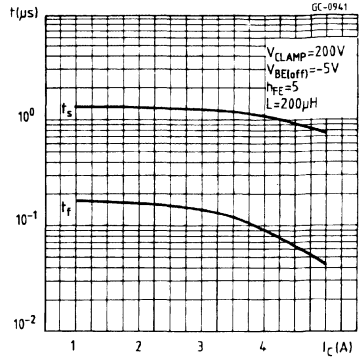

Switching Times Percentage Variation

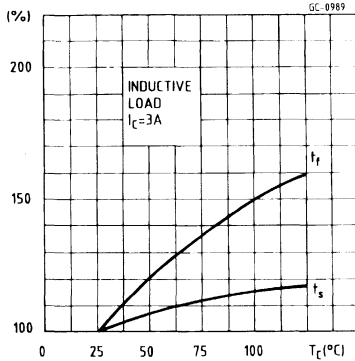

ISOWATT PACKAGES CHARACTERISTICS AND APPLICATION

The ISOWATT220 and ISOWATT218 are fully isolated packages. The ISOWATT220 is isolated to 2000V dc and the ISOWATT218 to 4000V dc. Their thermal impedance, given in the datasheet, is optimised to give efficient thermal conduction together with excellent electrical isolation.

The structure of the case ensures optimum distances between the pins and heatsink. For the ISOWATT218 these distances are in agreement with VDE and UL creepage and clearance standards. The ISOWATT218 is supplied with longer leads than the standard TO-218 to allow easy mounting on PCB's. The ISOWATT220 and ISOWATT218 packages eliminate the need for external isolation

so reducing fixing hardware. Accurate moulding techniques used in manufacture assures consistent heat spreader-to-heatsink capacitance.

The thermal performance of these packages is better than that of the standard part mounted with a 0.1mm mica washer. The thermally conductive plastic has a higher breakdown rating and is less fragile than mica or plastic sheets. Power derating for these ISOWATT packages is determined by :

$$P_D = \frac{T_j - T_c}{R_{th}}$$

THERMAL IMPEDANCE OF ISOWATT PACKAGES

Fig. 1 illustrates the elements contributing to the thermal resistance of a transistor heatsink assembly, using ISOWATT packages.

The total thermal resistance $R_{th(tot)}$ is the sum of each of these elements. The transient thermal impedance, Z_{th} for different pulse durations can be estimated as follows :

- 1 - For a short duration power pulse of less than 1ms :

$$Z_{th} < R_{thJ-C}$$

- 2 - For an intermediate power pulse of 5ms to 50ms seconds :

$$Z_{th} = R_{thJ-C}$$

- 3 - For long power pulses of the order of 500ms seconds or greater :

$$Z_{th} = R_{thJ-C} + R_{thC-HS} + R_{thHS-amb}$$

It is often possible to discern these areas on transient thermal impedance curves.

Figure 1.

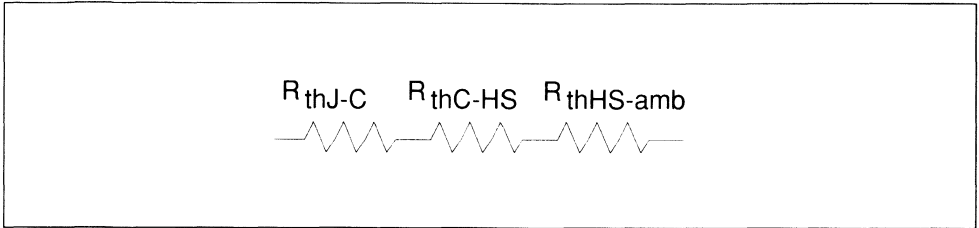

FASTSWITCH HOLLOW-EMITTER NPN TRANSISTORS

- HIGH SWITCHING SPEED NPN POWER TRANSISTORS
- HOLLOW EMITTER TECHNOLOGY
- HIGH VOLTAGE FOR OFF-LINE APPLICATIONS
- 70kHz SWITCHING SPEED
- LOW COST DRIVE CIRCUITS
- LOW DYNAMIC SATURATION

APPLICATIONS

- SMPS

DESCRIPTION

Hollow emitter FASTSWITCH NPN power transistors are specially designed for 220V (and 117V with input doubler) off-line switching power supply applications. Hollow emitter transistors can operate up

to 70kHz with simple drive circuits which helps to simplify designs and improve reliability. The superior switching performance reduces dissipation and consequently lowers the equipment operating temperature. These transistors are suitable for application in half bridge, push-pull and full bridge medium power transistor converters, 750W to 1500W. When used in conjunction with a low voltage Power MOSFET in emitter switch configuration, they can operate at up to 100kHz.

These hollow emitter FASTSWITCH transistors are available in TO-218 and the fully isolated ISOWATT218 packages. The ISOWATT218 conforms to the creepage distance and isolation requirements of VDE, IEC, and UL specifications. Additionally these FASTSWITCH transistors are available in metal TO-3 packages.

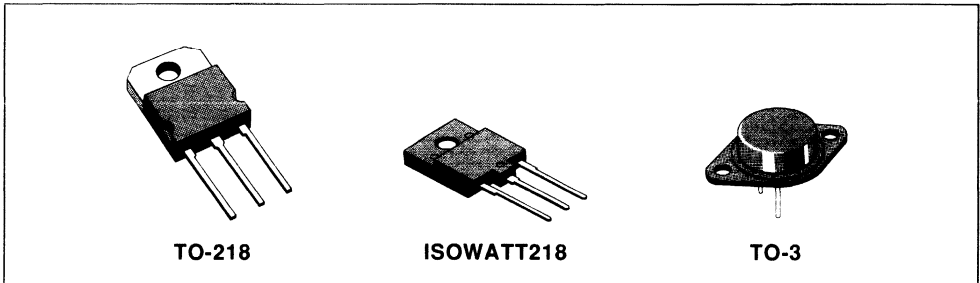

ABSOLUTE MAXIMUM RATINGS

Symbol	Parameter	SGS			Unit
		F461	IF461	F561	
V_{CES}	Collector - Emitter Voltage ($V_{BE} = 0$)	850			V
V_{CEO}	Collector - Emitter Voltage ($I_B = 0$)	400			V
V_{EBO}	Emitter - Base Voltage ($I_C = 0$)	7			V
I_C	Collector Current	15			A
I_{CM}	Collector Peak Current ($t_p < 5ms$)	25			A
I_B	Base Current	8			A
I_{BM}	Base Peak Current ($t_p < 5ms$)	15			A
P_{tot}	Total Dissipation at $T_c \leq 25^\circ C$	125	65	150	W
T_{stg}	Storage Temperature - 65 to	150	150	175	$^\circ C$
T_j	Junction Temperature	150	150	175	$^\circ C$

THERMAL DATA

			SGS			
			F461	IF461	F561	
R _{thj-case}	Thermal Resistance Junction-case	Max	1	1.92	1	°C/W

ELECTRICAL CHARACTERISTICS (T_{case} = 25°C unless otherwise specified)

Symbol	Parameter	Test Conditions	Min.	Typ.	Max.	Unit
I _{CES}	Collector Cutoff Current (V _{BE} = 0)	V _{CE} = 700V			200	μA
I _{CEO}	Collector Cutoff Current (I _B = 0)	V _{CE} = 380V V _{CE} = 400V			200 2	μA mA
I _{EBO}	Emitter Cutoff Current (I _C = 0)	V _{EB} = 7V			1	mA
V _{CE(sus)*}	Collector Emitter Sustaining Voltage	I _C = 0.1A	400			V
V _{CE(sat)*}	Collector Emitter Saturation Voltage	I _C = 10A I _B = 2A I _C = 5.5A I _B = 0.8A			1.5 1.5	V V
V _{BE(sat)*}	Base Emitter Saturation Voltage	I _C = 10A I _B = 2A I _C = 5.5A I _B = 0.8A			1.5 1.5	V V

RESISTIVE LOAD

Symbol	Parameter	Test Conditions	Min.	Typ.	Max.	Unit
t _{on}	Turn-on Time	I _C = 10A V _{CC} = 250V I _{B1} = 2A I _{B2} = -2I _{B1}		1	1.7	μs
t _s	Storage Time			1.4	2.3	μs
t _f	Fall Time			0.25	0.5	μs
t _{on}	Turn-on Time	I _C = 10A V _{CC} = 250V I _{B1} = 2A I _{B2} = -2I _{B1} With Antisaturation Network		1		μs
t _s	Storage Time			1		μs
t _f	Fall Time			0.15		μs
t _{on}	Turn-on Time	I _C = 10A V _{CC} = 250V I _{B1} = 2A V _{BE(off)} = -5V		1		μs
t _s	Storage Time			1		μs
t _f	Fall Time			0.06		μs

INDUCTIVE LOAD

Symbol	Parameter	Test Conditions	Min.	Typ.	Max.	Unit
t _s	Storage Time	I _C = 10A h _{FE} = 5 V _{CL} = 350V V _{BE(off)} = -5V L = 300μH R _{B(off)} = 1.2Ω		1.4	2.8	μs
t _f	Fall Time			0.1	0.2	μs
t _s	Storage Time	I _C = 10A h _{FE} = 5 V _{CL} = 350V V _{BE(off)} = -5V L = 300μH R _{B(off)} = 1.2Ω T _c = 100°C			4	μs
t _f	Fall Time				0.3	μs

* Pulsed : Pulse duration = 300μs, duty cycle = 1.5%

Safe Operating Areas

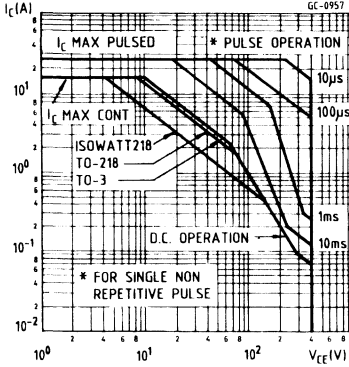

Reverse Biased Safe Operating Area

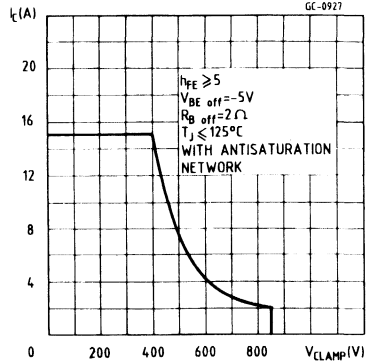

DC Current Gain

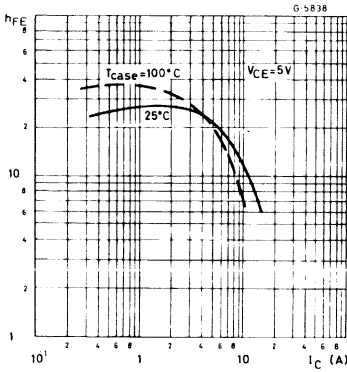

Collector-emitter Saturation Voltage

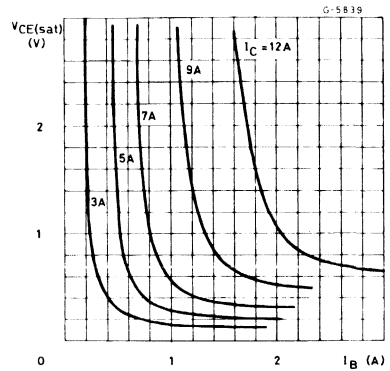

Collector-emitter Saturation Voltage

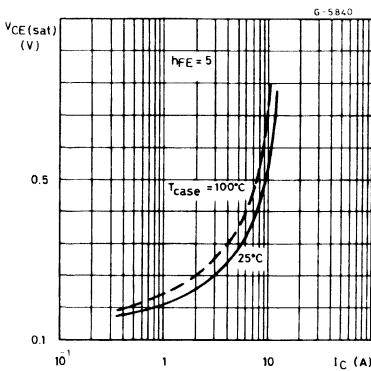

Base-emitter Saturation Voltage

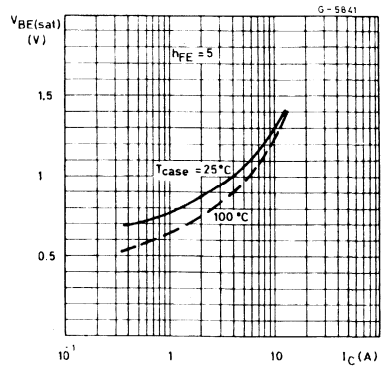

Resistive Load Switching Times

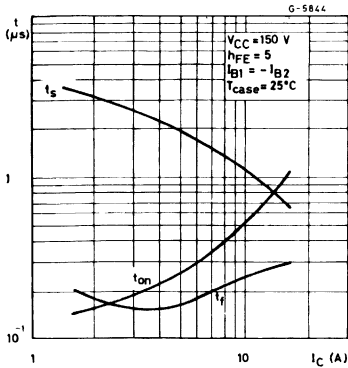

Inductive Load Switching Times

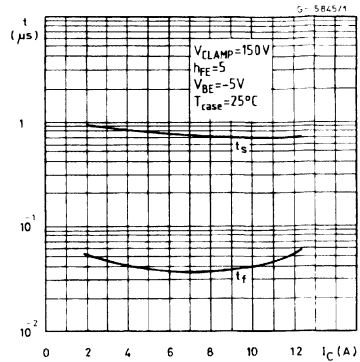

Switching Times Percentance Variation

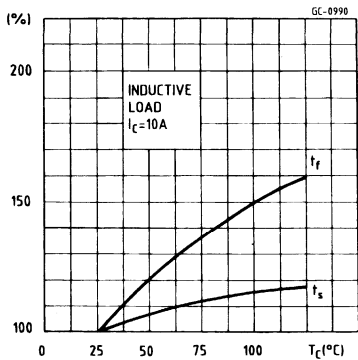

ISOWATT218 PACKAGE CHARACTERISTICS AND APPLICATION

ISOWATT218 is fully isolated to 4000V dc. Its thermal impedance, given in the data sheet, is optimised to give efficient thermal conduction together with excellent electrical isolation. The structure of the case ensures optimum distances between the pins and heatsink. These distances are in agreement with VDE and UL creepage and clearance standards. The ISOWATT218 package eliminates the need for external isolation so reducing fixing hardware.

The package is supplied with leads longer than the standard TO-218 to allow easy mounting on pcbs. Accurate moulding techniques used in manufacture

assures consistent heat spreader-to-heatsink capacitance.

ISOWATT218 thermal performance is equivalent to that of the standard part, mounted with a 0.1 mm mica washer. The thermally conductive plastic has a higher breakdown rating and is less fragile than mica or plastic sheets. Power derating for ISOWATT218 packages is determined by :

$$P_D = \frac{T_j - T_c}{R_{th}}$$

THERMAL IMPEDANCE OF ISOWATT218 PACKAGE

Fig. 1 illustrates the elements contributing to the thermal resistance of a transistor heatsink assembly, using ISOWATT218 package.

The total thermal resistance $R_{th(tot)}$ is the sum of each of these elements. The transient thermal impedance, Z_{th} for different pulse durations can be estimated as follows :

- 1 - For a short duration power pulse of less than 1ms :

$$Z_{th} < R_{thJ-C}$$

- 2 - For an intermediate power pulse of 5ms to 50ms seconds :

$$Z_{th} = R_{thJ-C}$$

- 3 - For long power pulses of the order of 500ms seconds or greater :

$$Z_{th} = R_{thJ-C} + R_{thC-HS} + R_{thHS-amb}$$

It is often possible to discern these areas on transient thermal impedance curves.

Figure 1.

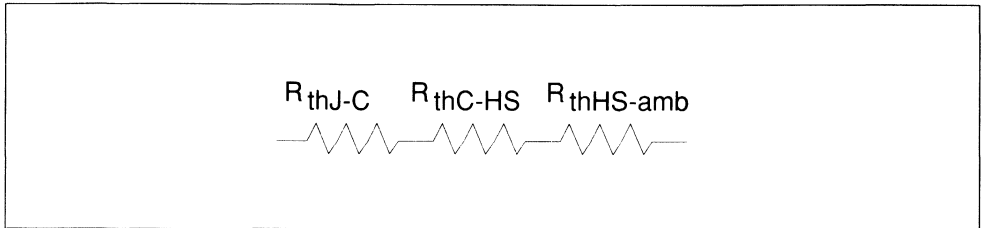



FASTSWITCH HOLLOW-EMITTER NPN TRANSISTORS

- HIGH SWITCHING SPEED NPN POWER TRANSISTORS
- HOLLOW EMITTER TECHNOLOGY
- HIGH VOLTAGE FOR OFF-LINE APPLICATIONS
- 70kHz SWITCHING SPEED
- LOW COST DRIVE CIRCUITS
- LOW DYNAMIC SATURATION

APPLICATIONS

- SMPS

DESCRIPTION

Hollow emitter FASTSWITCH NPN power transistors are specially designed for 240V (and 110V with input doubler) off-line switching power supply applications. Hollow emitter transistors can operate up to 70kHz with simple drive circuits which helps to

simplify designs and improve reliability. The superior switching performance reduces dissipation and consequently lowers the equipment operating temperature. The high voltage rating of these transistors allows simplification of the over voltage snubbing network. These transistors are suitable for applications in half bridge, push-pull and full bridge medium power converters, 550W to 1100W. When used in conjunction with a low voltage Power MOSFET in emitter switch configuration, they can operate at up to 100kHz.

These hollow emitter FASTSWITCH transistors are available in TO-218 and the fully isolated ISOWATT218 packages. The ISOWATT218 conforms to the creepage distance and isolation requirements of VDE, IEC, and UL specifications. Additionally these FASTSWITCH transistors are available in metal TO-3 packages.

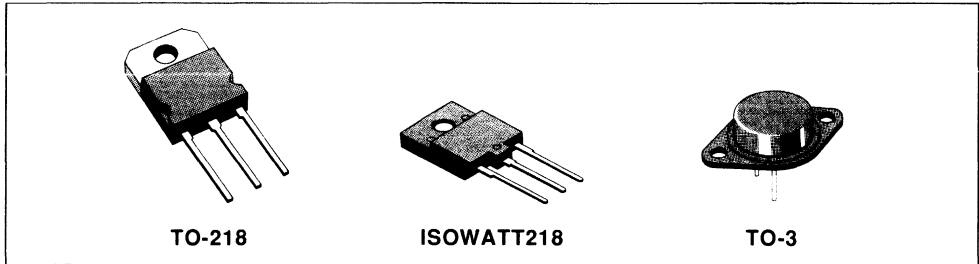

ABSOLUTE MAXIMUM RATINGS

Symbol	Parameter	SGS			Unit
		F463	IF463	F563	
V_{CES}	Collector - Emitter Voltage ($V_{BE} = 0$)	1000			V
V_{CEO}	Collector - Emitter Voltage ($I_B = 0$)	450			V
V_{EBO}	Emitter - Base Voltage ($I_C = 0$)	7			V
I_C	Collector Current	12			A
I_{CM}	Collector Peak Current ($t_p < 5ms$)	20			A
I_B	Base Current	7			A
I_{BM}	Base Peak Current ($t_p < 5ms$)	12			A
P_{tot}	Total Dissipation at $T_c \leq 25^\circ C$	125	65	150	W
T_{stg}	Storage Temperature - 65 to	150	150	175	$^\circ C$
T_j	Junction Temperature	150	150	175	$^\circ C$

THERMAL DATA

			SGS			
			F463	IF463	F563	
R _{thj-case}	Thermal Resistance Junction-case	Max	1	1.92	1	°C/W

ELECTRICAL CHARACTERISTICS (T_{case} = 25°C unless otherwise specified)

Symbol	Parameter	Test Conditions	Min.	Typ.	Max.	Unit
I _{CEs}	Collector Cutoff Current (V _{BE} = 0)	V _{CE} = 1000V			200	µA
I _{CEo}	Collector Cutoff Current (I _B = 0)	V _{CE} = 380V V _{CE} = 450V			200 2	µA mA
I _{EBo}	Emitter Cutoff Current (I _C = 0)	V _{EB} = 7V			1	mA
V _{CEo(sus)} *	Collector Emitter Sustaining Voltage	I _C = 0.1A	450			V
V _{CE(sat)} *	Collector Emitter Saturation Voltage	I _C = 7A I _C = 4A	I _B = 1.4A I _B = 0.6A		1.5 1.5	V V
V _{BE(sat)} *	Base Emitter Saturation Voltage	I _C = 7A I _C = 4A	I _B = 1.4A I _B = 0.6A		1.5 1.5	V V

RESISTIVE LOAD

Symbol	Parameter	Test Conditions	Min.	Typ.	Max.	Unit	
t _{on}	Turn-on Time	I _C = 7A I _{B1} = 1.4A	V _{CC} = 250V I _{B2} = -2I _{B1}		1	1.7	µs
t _s	Storage Time				1.4	2.3	µs
t _f	Fall Time				0.25	0.5	µs
t _{on}	Turn-on Time	I _C = 7A I _{B1} = 1.4A with Antisaturation Network	V _{CC} = 250V I _{B2} = -2I _{B1}		1		µs
t _s	Storage Time				1		µs
t _f	Fall Time				0.15		µs
t _{on}	Turn-on Time	I _C = 7A I _{B1} = 1.4A	V _{CC} = 250V V _{BE(off)} = -5V		1		µs
t _s	Storage Time				1		µs
t _f	Fall Time				0.06		µs

INDUCTIVE LOAD

Symbol	Parameter	Test Conditions	Min.	Typ.	Max.	Unit	
t _s	Storage Time	I _C = 7A V _{CL} = 350V L = 300µH	h _{FE} = 5 V _{BE(off)} = -5V R _{B(off)} = 1.2Ω		1.4	2.8	µs
t _f	Fall Time				0.1	0.2	µs
t _s	Storage Time	I _C = 7A V _{CL} = 350V L = 300µH T _C = 100°C	h _{FE} = 5 V _{BE(off)} = -5V R _{B(off)} = 1.2Ω			4	µs
t _f	Fall Time					0.3	µs

* Pulsed : Pulse duration = 300µs, duty cycle = 1.5%

Safe Operating Areas

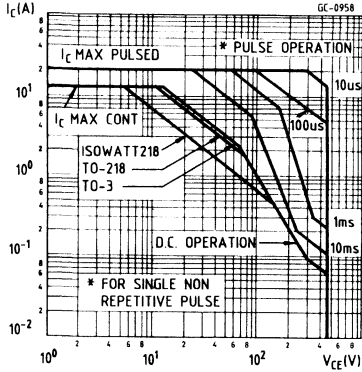

Reverse Biased Safe Operating Area

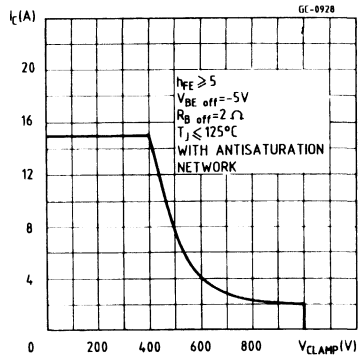

DC Current Gain

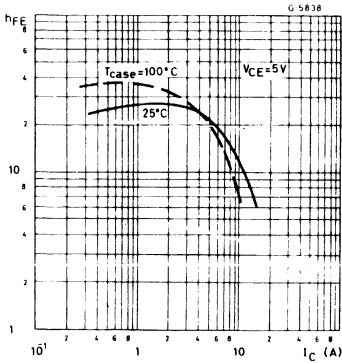

Collector-emitter Saturation Voltage

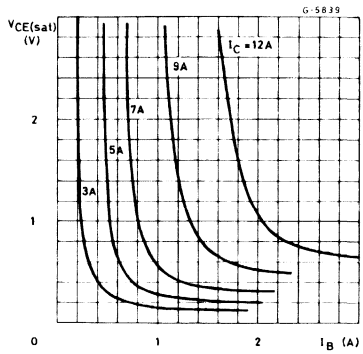

Collector-emitter Saturation Voltage

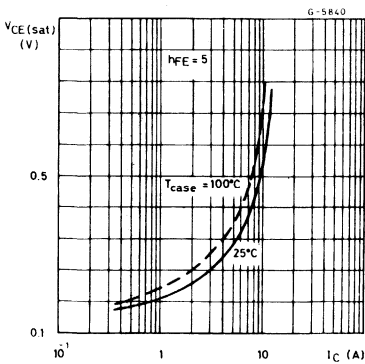

Base-emitter Saturation Voltage

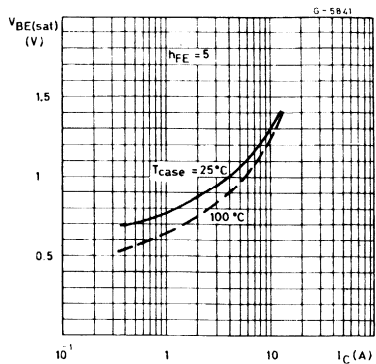

Resistive Load Switching Times

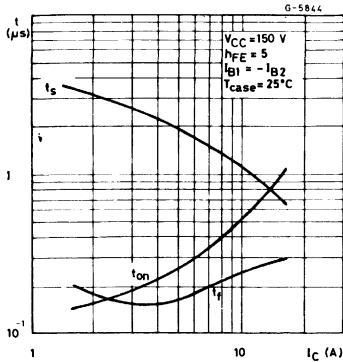

Inductive Load Switching Times

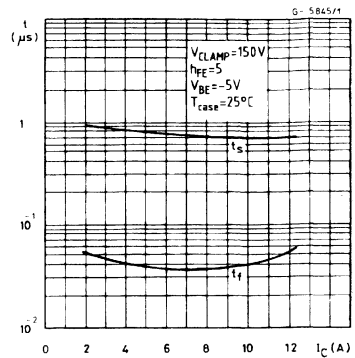

Switching Times Percentage Variation

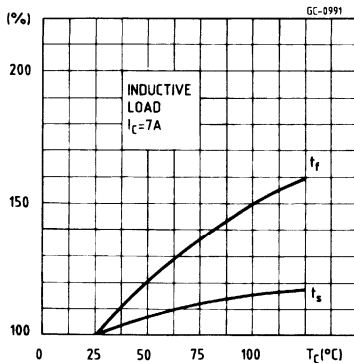

ISOWATT218 PACKAGE CHARACTERISTICS AND APPLICATION

ISOWATT218 is fully isolated to 4000V dc. Its thermal impedance, given in the data sheet, is optimised to give efficient thermal conduction together with excellent electrical isolation. The structure of the case ensures optimum distances between the pins and heatsink. These distances are in agreement with VDE and UL creepage and clearance standards. The ISOWATT218 package eliminates the need for external isolation so reducing fixing hardware.

The package is supplied with leads longer than the standard TO-218 to allow easy mounting on pcbs. Accurate moulding techniques used in manufacture

assures consistent heat spreader-to-heatsink capacitance.

ISOWATT218 thermal performance is equivalent to that of the standard part, mounted with a 0.1mm mica washer.

The thermally conductive plastic has a higher breakdown rating and is less fragile than mica or plastic sheets. Power derating for ISOWATT218 packages is determined by :

$$P_D = \frac{T_j - T_c}{R_{th}}$$

THERMAL IMPEDANCE OF ISOWATT218 PACKAGE

Fig. 1 illustrates the elements contributing to the thermal resistance of a transistor heatsink assembly, using ISOWATT218 package.

The total thermal resistance $R_{th(tot)}$ is the sum of each of these elements.

The transient thermal impedance, Z_{th} for different pulse durations can be estimated as follows :

1 - For a short duration power pulse of less than 1ms :

$$Z_{th} < R_{thJ-C}$$

2 - For an intermediate power pulse of 5ms to 50ms seconds :

$$Z_{th} = R_{thJ-C}$$

3 - For long power pulses of the order of 500ms seconds or greater :

$$Z_{th} = R_{thJ-C} + R_{thC-HS} + R_{thHS-amb}$$

It is often possible to discern these areas on transient thermal impedance curves.

Figure 1.

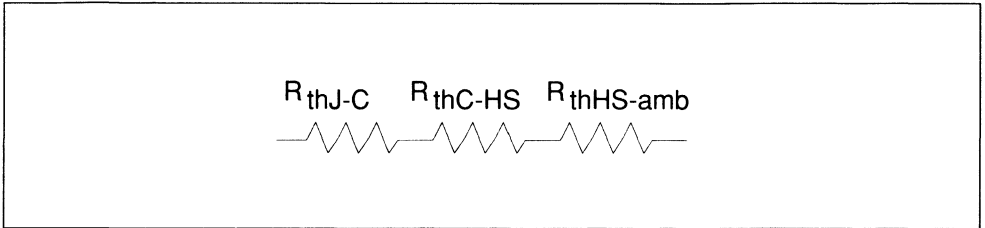

FASTSWITCH HOLLOW-EMITTER NPN TRANSISTORS

- HIGH SWITCHING SPEED NPN POWER TRANSISTORS
- HOLLOW EMITTER TECHNOLOGY
- HIGH VOLTAGE FOR OFF-LINE APPLICATIONS
- 50kHz SWITCHING SPEED
- LOW COST DRIVE CIRCUITS
- LOW DYNAMIC SATURATION

APPLICATIONS

- SMPS
- TV HORIZONTAL DEFLECTION

DESCRIPTION

These hollow emitter FASTSWITCH NPN power transistors are specially designed for 220V (and 117V with input doubler) off-line switching power supply and colour CRT deflection applications. Hollow emitter transistors can be used to advantage in

off-line switching power supply applications where their high voltage rating is a benefit in forward and flyback converters because a costly transformer clamp winding or over voltage snubbers can be omitted. High voltage hollow emitter transistors can operate up to 50kHz with simple drive circuits which help to simplify design and improve reliability. These transistors can also be used in half bridge, push-pull and full bridge medium power converters, 450W to 950W. When used in conjunction with a low voltage Power MOSFET in emitter switch configuration in flyback and forward converters, they can operate at up to 100kHz.

These hollow emitter FASTSWITCH transistors are available in TO-218 and fully isolated TO-218 packages. The ISOWATT218 conforms to the creepage distance and isolation requirements of VDE, IEC, and UL specifications. Additionally these FASTSWITCH transistors are available in metal TO-3 packages.

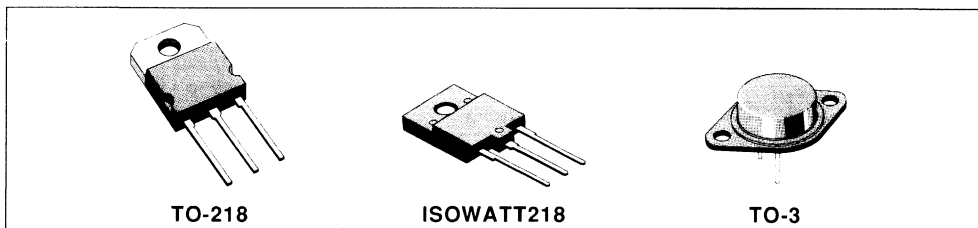

ABSOLUTE MAXIMUM RATINGS

Symbol	Parameter	SGS			Unit
		F464	IF464	F564	
V_{CEs}	Collector - Emitter Voltage ($V_{BE} = 0$)	1200			V
V_{CEO}	Collector - Emitter Voltage ($I_B = 0$)	600			V
V_{EBO}	Emitter - Base Voltage ($I_C = 0$)	7			V
I_C	Collector Current	10			A
I_{CM}	Collector Peak Current ($t_p < 5ms$)	15			A
I_B	Base Current	7			A
I_{BM}	Base Peak Current ($t_p < 5ms$)	12			A
P_{Tot}	Total Dissipation at $T_c \leq 25^\circ C$	125	65	150	W
T_{stg}	Storage Temperature - 65 to	150	150	175	$^\circ C$
T_j	Junction Temperature	150	150	175	$^\circ C$

THERMAL DATA

			SGS			
			F464	IF464	F564	
$R_{thj-case}$	Thermal Resistance Junction-case	Max	1	1.92	1	°C/W

ELECTRICAL CHARACTERISTICS ($T_{case} = 25^{\circ}C$ unless otherwise specified)

Symbol	Parameter	Test Conditions	Min.	Typ.	Max.	Unit
I_{CES}	Collector Cutoff Current ($V_{BE} = 0$)	$V_{CE} = 1200V$			200	μA
I_{CEO}	Collector Cutoff Current ($I_B = 0$)	$V_{CE} = 380V$ $V_{CE} = 600V$			200 2	μA mA
I_{EBO}	Emitter Cutoff Current ($I_C = 0$)	$V_{EB} = 7V$			1	mA
$V_{CEO(sus)}$ *	Collector Emitter Sustaining Voltage	$I_C = 0.1A$	600			V
$V_{CE(sat)}$ *	Collector Emitter Saturation Voltage	$I_C = 6A$ $I_B = 1.2A$ $I_C = 3.5A$ $I_B = 0.5A$			1.5 1.5	V V
$V_{BE(sat)}$ *	Base Emitter Saturation Voltage	$I_C = 6A$ $I_B = 1.2A$ $I_C = 3.5A$ $I_B = 0.5A$			1.5 1.5	V V

RESISTIVE LOAD

Symbol	Parameter	Test Conditions	Min.	Typ.	Max.	Unit
t_{on}	Turn-on Time	$I_C = 6A$ $V_{CC} = 250V$ $I_{B1} = 1.2A$ $I_{B2} = -2I_{B1}$		0.6	1.2	μs
t_s	Storage Time			2.45	3.5	μs
t_f	Fall Time			0.12	0.4	μs
t_{on}	Turn-on Time	$I_C = 6A$ $V_{CC} = 250V$ $I_{B1} = 1.2A$ $I_{B2} = -2I_{B1}$ With Antisaturation Network		0.6		μs
t_s	Storage Time			1.7		μs
t_f	Fall Time			0.12		μs
t_{on}	Turn-on Time	$I_C = 6A$ $V_{CC} = 250V$ $I_{B1} = 1.2A$ $V_{BE(off)} = -5V$		0.6		μs
t_s	Storage Time			1.3		μs
t_f	Fall Time			0.2		μs

INDUCTIVE LOAD

Symbol	Parameter	Test Conditions	Min.	Typ.	Max.	Unit
t_s	Storage Time	$I_C = 6A$ $h_{FE} = 5$ $V_{CL} = 450V$ $V_{BE(off)} = -5V$ $L = 300\mu H$ $R_{B(off)} = 0.8\Omega$		1.4	2.8	μs
t_f	Fall Time			0.1	0.2	μs
t_s	Storage Time	$I_C = 6A$ $h_{FE} = 5$ $V_{CL} = 450V$ $V_{BE(off)} = -5V$ $L = 300\mu H$ $R_{B(off)} = 0.8\Omega$ $T_c = 100^{\circ}C$			4	μs
t_f	Fall Time				0.3	μs

* Pulsed : Pulse duration = 300 μs , duty cycle = 1.5%

Safe Operating Areas

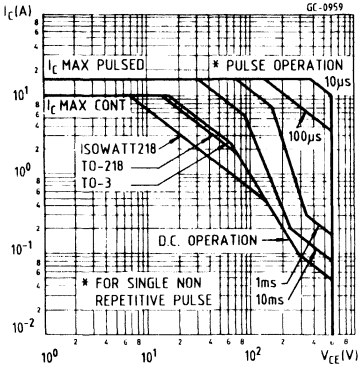

Reverse Biased Safe Operating Area

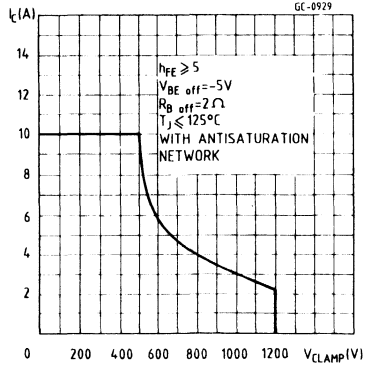

DC Current Gain

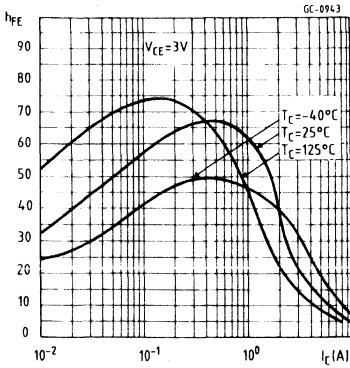

Collector-emitter Saturation Voltage

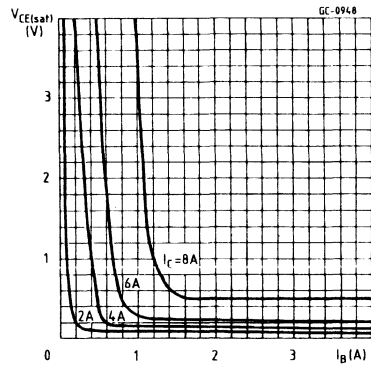

Collector-emitter Saturation Voltage

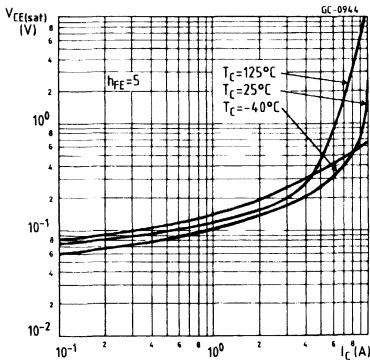

Base-emitter Saturation Voltage

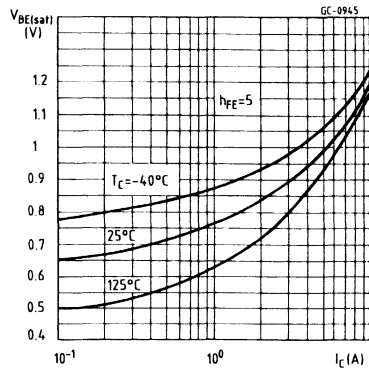

Resistive Load Switching Times

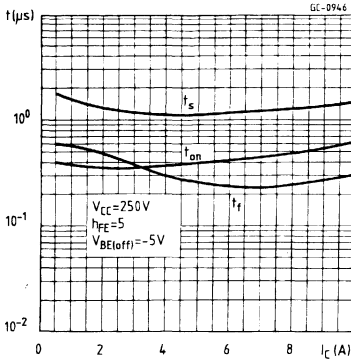

Inductive Load Switching Times

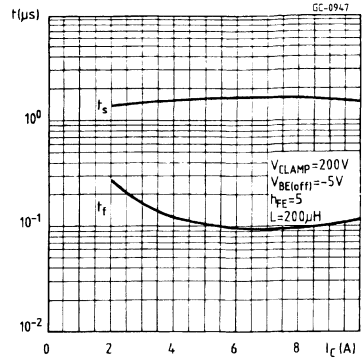

Switching Times Percentage Variation

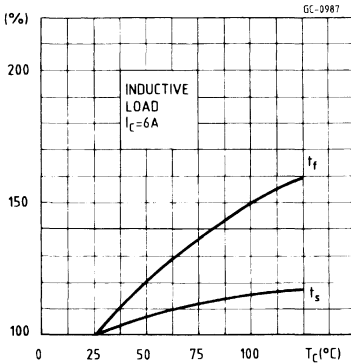

ISOWATT218 PACKAGE CHARACTERISTICS AND APPLICATION

ISOWATT218 is fully isolated to 4000V dc. Its thermal impedance, given in the data sheet, is optimised to give efficient thermal conduction together with excellent electrical isolation. The structure of the case ensures optimum distances between the pins and heatsink. These distances are in agreement with VDE and UL creepage and clearance standards. The ISOWATT218 package eliminates the need for external isolation so reducing fixing hardware.

The package is supplied with leads longer than the standard TO-218 to allow easy mounting on pcbs. Accurate moulding techniques used in manufacture

assures consistent heat spreader-to-heatsink capacitance.

ISOWATT218 thermal performance is equivalent to that of the standard part, mounted with a 0.1mm mica washer. The thermally conductive plastic has a higher breakdown rating and is less fragile than mica or plastic sheets. Power derating for ISOWATT218 packages is determined by :

$$P_D = \frac{T_j - T_c}{R_{th}}$$

THERMAL IMPEDANCE OF ISOWATT218 PACKAGE

Fig. 1 illustrates the elements contributing to the thermal resistance of a transistor heatsink assembly, using ISOWATT218 package.

The total thermal resistance $R_{th(tot)}$ is the sum of each of these elements.

The transient thermal impedance, Z_{th} for different pulse durations can be estimated as follows :

- 1 - For a short duration power pulse of less than 1ms :

$$Z_{th} < R_{thJ-C}$$

- 2 - For an intermediate power pulse of 5ms to 50ms seconds :

$$Z_{th} = R_{thJ-C}$$

- 3 - For long power pulses of the order of 500ms seconds or greater :

$$Z_{th} = R_{thJ-C} + R_{thC-HS} + R_{thHS-amb}$$

It is often possible to discern these areas on transient thermal impedance curves.

Figure 1.

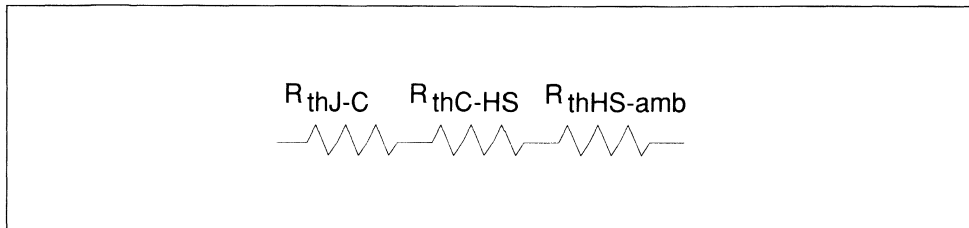

FASTSWITCH HOLLOW-EMITTER NPN TRANSISTORS

- HIGH SWITCHING SPEED NPN POWER TRANSISTORS
- HOLLOW EMITTER FOR FAST SWITCHING
- HIGH VOLTAGE FOR OFF-LINE APPLICATIONS
- 50kHz SWITCHING SPEED WITH EASY DRIVE CIRCUITS
- LOW COST DRIVE CIRCUITS
- LOW DYNAMIC SATURATION

APPLICATIONS

- SMPS
- TV HORIZONTAL DEFLECTION

DESCRIPTION

These hollow emitter FASTSWITCH NPN power transistors are specially designed for 220V (and 117V with input doubler) off-line switching power supply and colour CRT deflection applications. Hol-

low emitter transistors can be used to advantage in off-line switching power supply applications where their high voltage rating is a benefit in forward and flyback medium power converters because a costly transformer clamp winding or over voltage snubbers can be omitted. High voltage hollow emitter transistors can operate up to 50kHz with simple drive circuits which help to simplify design and improve reliability. When used in conjunction with a low voltage Power MOSFET in emitter switch configuration in flyback and forward converters, they can operate at up to 100kHz.

These hollow emitter FASTSWITCH transistors are available in TO-218 and fully isolated TO-218 packages. The ISOWATT218 conforms to the creepage distance and isolation requirements of VDE, IEC, and UL specifications. Additionally these FASTSWITCH transistors are available in metal TO-3 packages.

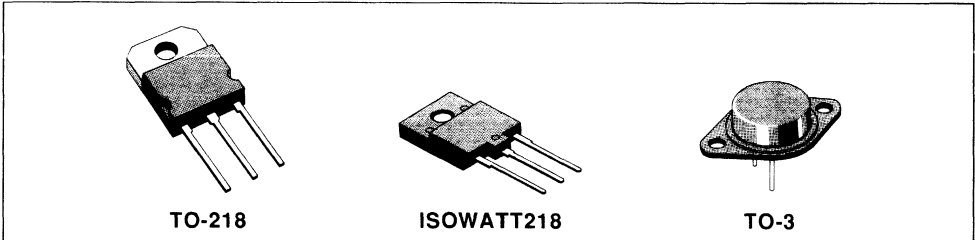

ABSOLUTE MAXIMUM RATINGS

Symbol	Parameter	SGS			Unit
		F465	IF465	F565	
V_{CES}	Collector - Emitter Voltage ($V_{BE} = 0$)	1300			V
V_{CEO}	Collector - Emitter Voltage ($I_B = 0$)	600			V
V_{EBO}	Emitter - Base Voltage ($I_C = 0$)	7			V
I_C	Collector Current	10			A
I_{CM}	Collector Peak Current ($t_p < 5ms$)	15			A
I_B	Base Current	7			A
I_{BM}	Base Peak Current ($t_p < 5ms$)	12			A
P_{Tot}	Total Dissipation at $T \leq 25^\circ C$	125	65	150	W
T_{stg}	Storage Temperature - 65 to	150	150	175	$^\circ C$
T_j	Junction Temperature	150	150	175	$^\circ C$

THERMAL DATA

		Max	SGS			°C/W
			F465	IF465	F565	
$R_{thj-case}$	Thermal Resistance Junction-case		1	1.92	1	

ELECTRICAL CHARACTERISTICS ($T_{case} = 25^{\circ}\text{C}$ unless otherwise specified)

Symbol	Parameter	Test Conditions	Min.	Typ.	Max.	Unit
I_{CES}	Collector Cutoff Current ($V_{BE} = 0$)	$V_{CE} = 1300\text{V}$			200	μA
I_{CEO}	Collector Cutoff Current ($I_B = 0$)	$V_{CE} = 380\text{V}$ $V_{CE} = 600\text{V}$			200 2	μA mA
I_{EBO}	Emitter Cutoff Current ($I_C = 0$)	$V_{EB} = 7\text{V}$			1	mA
$V_{CEO(sus)}$ *	Collector Emitter Sustaining Voltage	$I_C = 0.1\text{A}$	600			V
$V_{CE(sat)}$ *	Collector Emitter Saturation Voltage	$I_C = 5\text{A}$ $I_B = 1\text{A}$ $I_C = 3\text{A}$ $I_B = 0.4\text{A}$			1.5 1.5	V V
$V_{BE(sat)}$ *	Base Emitter Saturation Voltage	$I_C = 5\text{A}$ $I_B = 1\text{A}$ $I_C = 3\text{A}$ $I_B = 0.4\text{A}$			1.5 1.5	V V

RESISTIVE LOAD

Symbol	Parameter	Test Conditions	Min.	Typ.	Max.	Unit
t_{on}	Turn-on Time	$I_C = 5\text{A}$ $V_{CC} = 250\text{V}$ $I_{B1} = 1\text{A}$ $I_{B2} = -2I_{B1}$		0.6	1.2	μs
t_s	Storage Time			2.45	3.5	μs
t_f	Fall Time			0.12	0.4	μs
t_{on}	Turn-on Time	$I_C = 5\text{A}$ $V_{CC} = 250\text{V}$ $I_{B1} = 1\text{A}$ $I_{B2} = -2I_{B1}$ With Antisaturation Network		0.6		μs
t_s	Storage Time			1.7		μs
t_f	Fall Time			0.12		μs
t_{on}	Turn-on Time	$I_C = 5\text{A}$ $V_{CC} = 250\text{V}$ $I_{B1} = 1\text{A}$ $V_{BE(off)} = -5\text{V}$		0.6		μs
t_s	Storage Time			1.3		μs
t_f	Fall Time			0.2		μs

INDUCTIVE LOAD

Symbol	Parameter	Test Conditions	Min.	Typ.	Max.	Unit
t_s	Storage Time	$I_C = 5\text{A}$ $h_{FE} = 5$ $V_{CL} = 450\text{V}$ $V_{BE(off)} = -5\text{V}$ $L = 300\mu\text{H}$ $R_{B(off)} = 0.8\Omega$		1.4	2.8	μs
t_f	Fall Time			0.1	0.2	μs
t_s	Storage Time	$I_C = 5\text{A}$ $h_{FE} = 5$ $V_{CL} = 450\text{V}$ $V_{BE(off)} = -5\text{V}$ $L = 300\mu\text{H}$ $R_{B(off)} = 0.8\Omega$ $T_C = 100^{\circ}\text{C}$			4	μs
t_f	Fall Time				0.3	μs

* Pulsed : Pulse duration = 300 μs , duty cycle = 1.5%

Safe Operating Areas

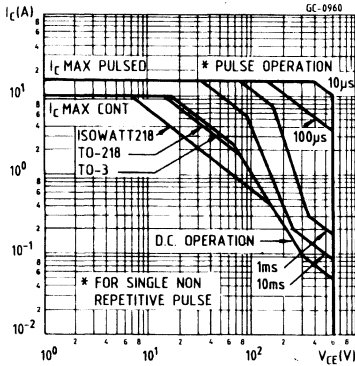

Reverse Biased Safe Operating Area

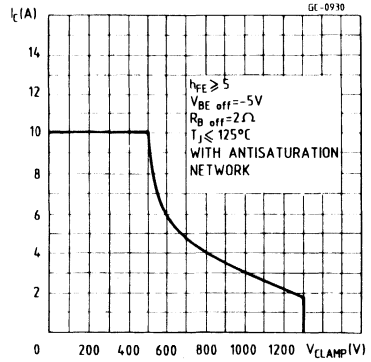

DC Current Gain

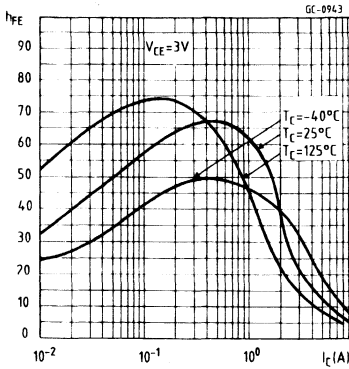

Collector-emitter Saturation Voltage

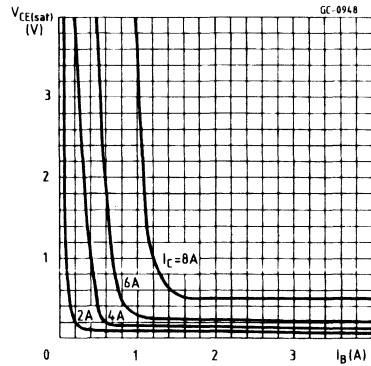

Collector-emitter Saturation Voltage

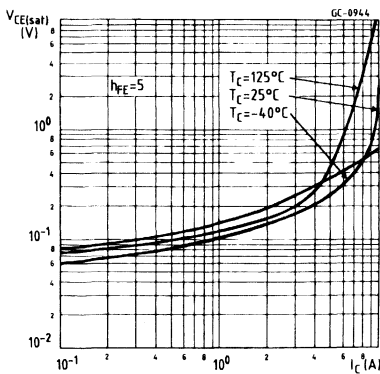

Base-emitter Saturation Voltage

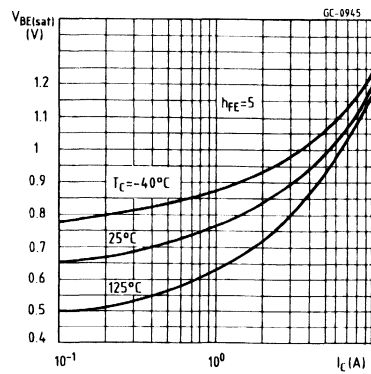

Resistive Load Switching Times

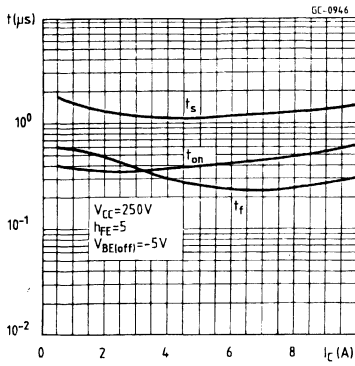

Inductive Load Switching Times

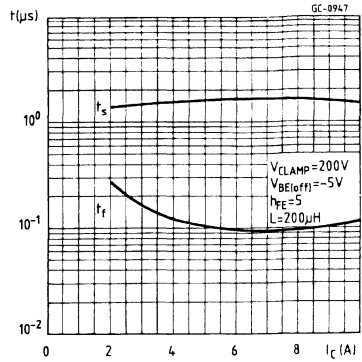

Switching Times Percentance Variation

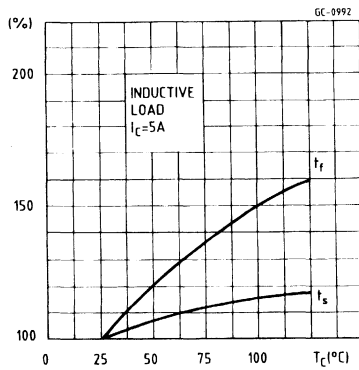

ISOWATT218 PACKAGE CHARACTERISTICS AND APPLICATION

ISOWATT218 is fully isolated to 4000V dc. Its thermal impedance, given in the data sheet, is optimised to give efficient thermal conduction together with excellent electrical isolation. The structure of the case ensures optimum distances between the pins and heatsink. These distances are in agreement with VDE and UL creepage and clearance standards. The ISOWATT218 package eliminates the need for external isolation so reducing fixing hardware.

The package is supplied with leads longer than the standard TO-218 to allow easy mounting on pcbs. Accurate moulding techniques used in manufacture

assures consistent heat spreader-to-heatsink capacitance.

ISOWATT218 thermal performance is equivalent to that of the standard part, mounted with a 0.1mm mica washer. The thermally conductive plastic has a higher breakdown rating and is less fragile than mica or plastic sheets. Power derating for ISOWATT218 packages is determined by :

$$P_D = \frac{T_j - T_c}{R_{th}}$$

THERMAL IMPEDANCE OF ISOWATT218 PACKAGE

Fig. 1 illustrates the elements contributing to the thermal resistance of a transistor heatsink assembly, using ISOWATT218 package.

The total thermal resistance $R_{th(tot)}$ is the sum of each of these elements.

The transient thermal impedance, Z_{th} for different pulse durations can be estimated as follows :

- 1 - For a short duration power pulse of less than 1ms :

$$Z_{th} < R_{thJ-C}$$

- 2 - For an intermediate power pulse of 5ms to 50ms seconds :

$$Z_{th} = R_{thJ-C}$$

- 3 - For long power pulses of the order of 500ms seconds or greater :

$$Z_{th} = R_{thJ-C} + R_{thC-HS} + R_{thHS-amb}$$

It is often possible to discern these areas on transient thermal impedance curves.

Figure 1.

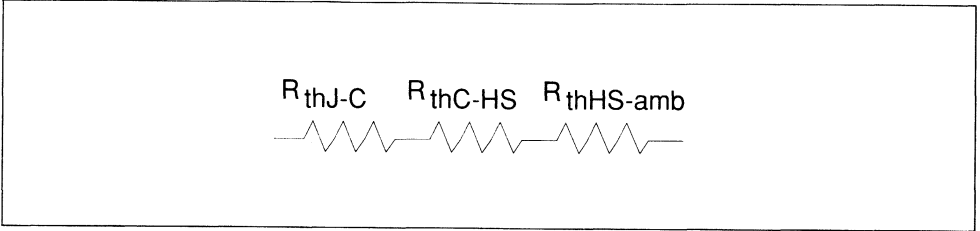

FASTSWITCH HOLLOW-EMITTER NPN TRANSISTOR

- HIGH SWITCHING SPEED NPN POWER TRANSISTOR
- HOLLOW EMITTER TECHNOLOGY
- HIGH VOLTAGE FOR OFF-LINE APPLICATIONS
- 70kHz SWITCHING SPEED
- LOW COST DRIVE CIRCUITS
- LOW DYNAMIC SATURATION

APPLICATIONS

- SMPS

DESCRIPTION

This hollow emitter FASTSWITCH NPN power transistor is specially designed for 220V (and 117V with input doubler) off-line switching power supply

applications. It can also be used for 117V three phase mains off-line switching power supplies. Hollow emitter transistors can operate up to 70kHz with simple drive circuits which helps to simplify designs and improve reliability. The superior switching performance reduces dissipation and consequently lowers the equipment operating temperature. This transistor is suitable for application in half bridge and full bridge high power converters, 1500W to 3000W. When used in conjunction with a low voltage Power MOSFET in emitter switch configuration in fly-back and forward converters, they can operate at up to 100kHz.

This hollow emitter FASTSWITCH transistor is available in the metal can TO-3 package.

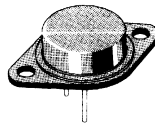

TO-3

ABSOLUTE MAXIMUM RATINGS

Symbol	Parameter	SGSF661	Unit
V_{CES}	Collector - Emitter Voltage ($V_{BE} = 0$)	850	V
V_{CEO}	Collector - Emitter Voltage ($I_B = 0$)	400	V
V_{EBO}	Emitter - Base Voltage ($I_C = 0$)	7	V
I_C	Collector Current	30	A
I_{CM}	Collector Peak Current ($t_p < 5ms$)	50	A
I_B	Base Current	16	A
I_{BM}	Base Peak Current ($t_p < 5ms$)	30	A
P_{tot}	Total Dissipation at $T_c \leq 25^\circ C$	250	W
T_{stg}	Storage Temperature - 65 to	175	$^\circ C$
T_j	Junction Temperature	175	$^\circ C$

THERMAL DATA

$R_{thj-case}$	Thermal Resistance Junction-case	Max	0.6	°C/W
----------------	----------------------------------	-----	-----	------

ELECTRICAL CHARACTERISTICS ($T_{case} = 45^{\circ}\text{C}$ unless otherwise specified)

Symbol	Parameter	Test Conditions	Min.	Typ.	Max.	Unit
I_{CES}	Collector Cutoff Current ($V_{BE} = 0$)	$V_{CE} = 700\text{V}$			400	μA
I_{CEO}	Collector Cutoff Current ($I_B = 0$)	$V_{CE} = 380\text{V}$ $V_{CE} = 400\text{V}$			400 4	μA mA
I_{EBO}	Emitter Cutoff Current ($I_C = 0$)	$V_{EB} = 7\text{V}$			2	mA
$V_{CEO(sus)}$ *	Collector Emitter Sustaining Voltage	$I_C = 0.2\text{A}$	400			V
$V_{CE(sat)}$ *	Collector Emitter Saturation Voltage	$I_C = 20\text{A}$ $I_B = 4\text{A}$ $I_C = 11\text{A}$ $I_B = 1.6\text{A}$			1.5 1.5	V V
$V_{BE(sat)}$ *	Base Emitter Saturation Voltage	$I_C = 20\text{A}$ $I_B = 4\text{A}$ $I_C = 11\text{A}$ $I_B = 1.6\text{A}$			1.5 1.5	V V

RESISTIVE LOAD

Symbol	Parameter	Test Conditions	Min.	Typ.	Max.	Unit
t_{on}	Turn-on Time	$I_C = 20\text{A}$ $V_{CC} = 250\text{V}$ $I_{B1} = 4\text{A}$ $I_{B2} = -2 I_{B1}$		1	1.7	μs
t_s	Storage Time			1.4	2.3	μs
t_f	Fall Time			0.25	0.5	μs
t_{on}	Turn-on Time	$I_C = 20\text{A}$ $V_{CC} = 250\text{V}$ $I_{B1} = 4\text{A}$ $I_{B2} = -2 I_{B1}$ with Antisaturation Network		1		μs
t_s	Storage Time			1		μs
t_f	Fall Time			0.15		μs
t_{on}	Turn-on Time	$I_C = 20\text{A}$ $V_{CC} = 250\text{V}$ $I_{B1} = 4\text{A}$ $V_{BE(off)} = -5\text{V}$		1		μs
t_s	Storage Time			1		μs
t_f	Fall Time			0.06		μs

INDUCTIVE LOAD

Symbol	Parameter	Test Conditions	Min.	Typ.	Max.	Unit
t_s	Storage Time	$I_C = 20\text{A}$ $h_{FE} = 5$ $V_{CL} = 350\text{V}$ $V_{BE(off)} = -5\text{V}$ $L = 300\mu\text{H}$ $R_{B(off)} = 1\Omega$		1.5	3.2	μs
t_f	Fall Time			0.12	0.25	μs
t_s	Storage Time	$I_C = 20\text{A}$ $h_{FE} = 5$ $V_{CL} = 350\text{V}$ $V_{BE(off)} = -5\text{V}$ $L = 300\mu\text{H}$ $R_{B(off)} = 1\Omega$ $T_C = 100^{\circ}\text{C}$			4.5	μs
t_f	Fall Time				0.35	μs

* Pulsed : Pulse duration = 300 μs , duty cycle = 1.5%

Safe Operating Areas

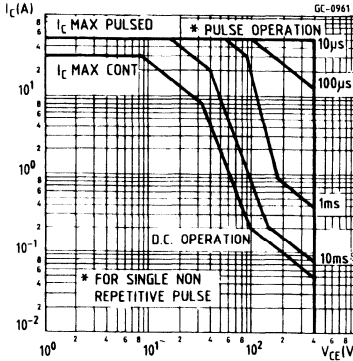

Reverse Biased Safe Operating Area

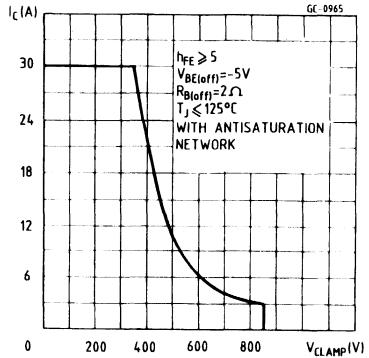

DC Current Gain

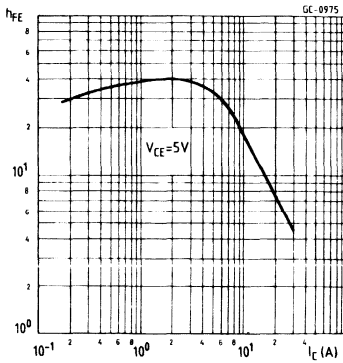

Collector-emitter Saturation Voltage

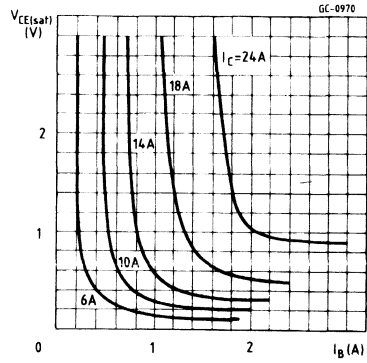

Collector-emitter Saturation Voltage

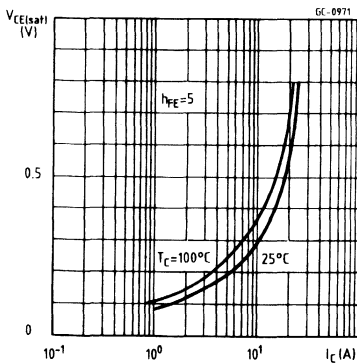

Base-emitter Saturation Voltage

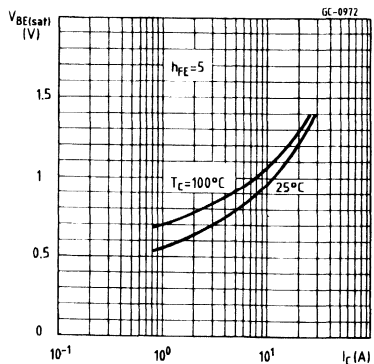

Resistive Load Switching Times

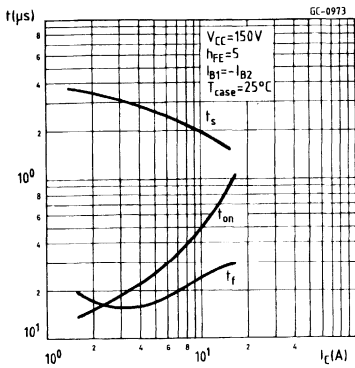

Inductive Load Switching Times

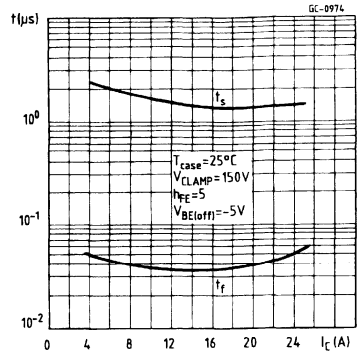

Switching Times Percentage Variation

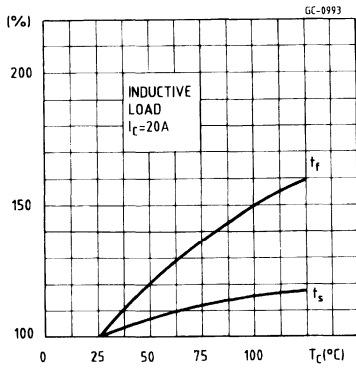

FASTSWITCH HOLLOW-EMITTER NPN TRANSISTOR

- HIGH SWITCHING SPEED NPN POWER TRANSISTOR
- HOLLOW EMITTER TECHNOLOGY
- HIGH VOLTAGE FOR OFF-LINE APPLICATIONS
- 70kHz SWITCHING SPEED
- LOW COST DRIVE CIRCUITS
- LOW DYNAMIC SATURATION

APPLICATIONS

- SMPS

DESCRIPTION

This hollow emitter FASTSWITCH NPN power transistor is specially designed for 220V (and 117V with

input doubler) off-line switching power supply applications. It can also be used for 117V three phase mains off-line switching power supplies. Hollow emitter can operate up to 70kHz with simple drive circuits which helps to simplify design and improve reliability. The superior switching performance reduces dissipation and consequently lowers the equipment operating temperature. This transistor is suitable for applications in half bridge and full bridge high power converters, 1000W to 2000W. When used in conjunction with a low voltage Power MOS-FET in emitter switch configuration, they can operate at up to 100kHz.

This hollow emitter FASTSWITCH transistor is available in the metal can TO-3 package.

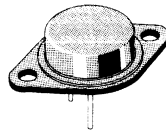

TO-3

ABSOLUTE MAXIMUM RATINGS

Symbol	Parameter	SGSF663	Unit
V_{CES}	Collector - Emitter Voltage ($V_{BE} = 0$)	1000	V
V_{CEO}	Collector - Emitter Voltage ($I_B = 0$)	450	V
V_{EBO}	Emitter - Base Voltage ($I_C = 0$)	7	V
I_C	Collector Current	24	A
I_{CM}	Collector Peak Current ($t_p < 5ms$)	40	A
I_B	Base Current	14	A
I_{BM}	Base Peak Current ($t_p < 5ms$)	24	A
P_{Tot}	Total Dissipation at $T_c \leq 25^\circ C$	250	W
T_{stg}	Storage Temperature - 65 to	175	$^\circ C$
T_j	Junction Temperature	175	$^\circ C$

THERMAL DATA

$R_{thj-case}$	Thermal Resistance Junction-case	Max	0.6	°C/W
----------------	----------------------------------	-----	-----	------

ELECTRICAL CHARACTERISTICS ($T_{case} = 25^{\circ}C$ unless otherwise specified)

Symbol	Parameter	Test Conditions	Min.	Typ.	Max.	Unit
I_{CES}	Collector Cutoff Current ($V_{BE} = 0$)	$V_{CE} = 1000V$			400	μA
I_{CEO}	Collector Cutoff Current ($I_B = 0$)	$V_{CE} = 380V$ $V_{CE} = 450V$			400 4	μA mA
I_{EBO}	Emitter Cutoff Current ($I_C = 0$)	$V_{EB} = 7V$			2	mA
$V_{CEO(sus)}$ *	Collector Emitter Sustaining Voltage	$I_C = 0.2A$	450			V
$V_{CE(sat)}$ *	Collector Emitter Saturation Voltage	$I_C = 14A$ $I_B = 2.8A$ $I_C = 8A$ $I_B = 1.2A$			1.5 1.5	V V
$V_{BE(sat)}$ *	Base Emitter Saturation Voltage	$I_C = 14A$ $I_B = 2.8A$ $I_C = 8A$ $I_B = 1.2A$			1.5 1.5	V V

RESISTIVE LOAD

Symbol	Parameter	Test Conditions	Min.	Typ.	Max.	Unit
t_{on}	Turn-on Time	$I_C = 14A$ $V_{CC} = 250V$ $I_{B1} = 2.8A$ $I_{B2} = -2I_{B1}$		1	1.7	μs
t_s	Storage Time			1.4	2.3	μs
t_f	Fall Time			0.25	0.5	μs
t_{on}	Turn-on Time	$I_C = 14A$ $V_{CC} = 250V$ $I_{B1} = 2.8A$ $I_{B2} = -2I_{B1}$ With Antisaturation Network		1		μs
t_s	Storage Time			1		μs
t_f	Fall Time			0.15		μs
t_{on}	Turn-on Time	$I_C = 14A$ $V_{CC} = 250V$ $I_{B1} = 2.8A$ $V_{BE(off)} = -5V$		1		μs
t_s	Storage Time			1		μs
t_f	Fall Time			0.06		μs

INDUCTIVE LOAD

Symbol	Parameter	Test Conditions	Min.	Typ.	Max.	Unit
t_s	Storage Time	$I_C = 14A$ $h_{FE} = 5$ $V_{CL} = 350V$ $V_{BE(off)} = -5V$ $L = 300\mu H$ $R_{B(off)} = 1\Omega$		1.5	3.2	μs
t_f	Fall Time			0.12	0.25	μs
t_s	Storage Time	$I_C = 14A$ $h_{FE} = 5$ $V_{CL} = 350V$ $V_{BE(off)} = -5V$ $L = 300\mu H$ $R_{B(off)} = 1\Omega$ $T_C = 100^{\circ}C$			4.3	μs
t_f	Fall Time				0.35	μs

* Pulsed : Pulse duration = 300 μs , duty cycle = 1.5%

Safe Operating Areas

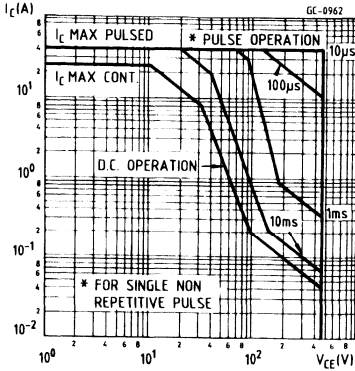

Reverse Biased Safe Operating Area

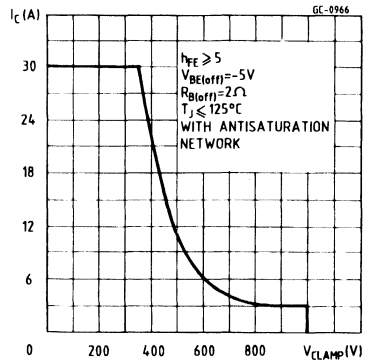

DC Current Gain

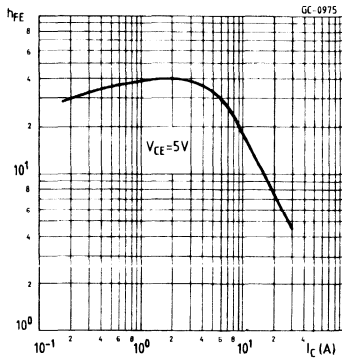

Collector-emitter Saturation Voltage

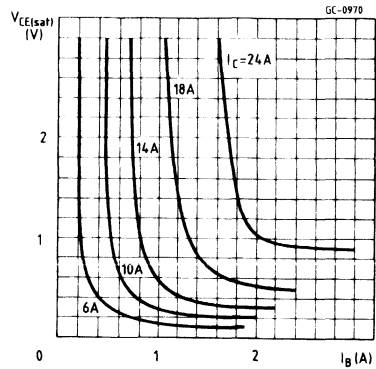

Collector-emitter Saturation Voltage

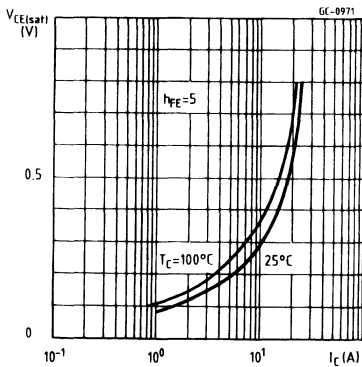

Base-emitter Saturation Voltage

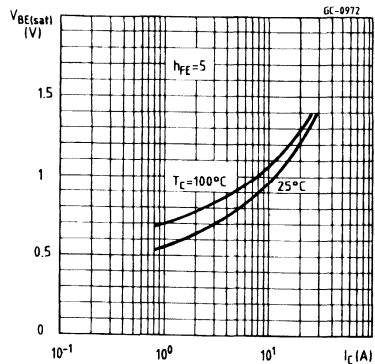

Resistive Load Switching Times

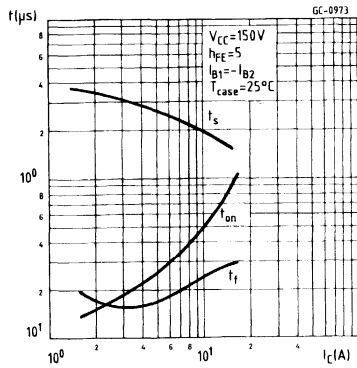

Inductive Load Switching Times

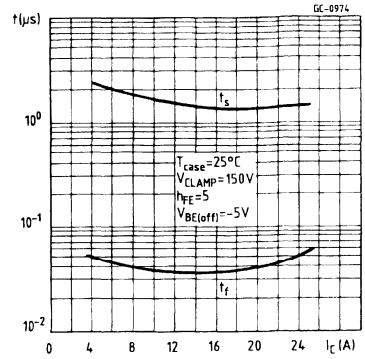

Switching Times Percentage Variation

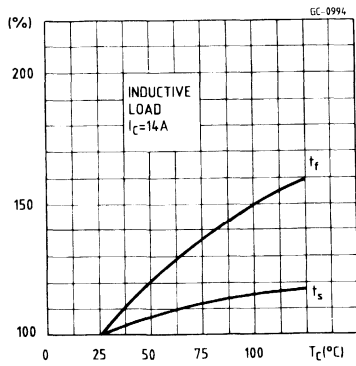

FASTSWITCH HOLLOW-EMITTER NPN TRANSISTOR

- HIGH SWITCHING SPEED NPN POWER TRANSISTOR
- HOLLOW EMITTER TECHNOLOGY
- HIGH VOLTAGE FOR OFF-LINE APPLICATIONS
- 50kHz SWITCHING SPEED
- LOW COST DRIVE CIRCUITS
- LOW DYNAMIC SATURATION

APPLICATIONS

- SMPS
- TV AND MONITOR DEFLECTION

DESCRIPTION

This hollow emitter FASTSWITCH NPN power transistor is specially designed for 220V (and 117V with input doubler) off-line switching power supply applications. It can also be used for 117V three

phase mains off-line switching power supplies. Hollow emitter transistors can operate at up to 50kHz with simple drive circuits which helps to simplify design and improve reliability. The superior switching performance reduces dissipation and consequently lowers the equipment operating temperature. This transistor is suitable for applications in half bridge and full bridge high power converters, 900W to 1800W. The high switching speed of this transistor together with its high voltage and current rating, make it ideal for horizontal deflection circuits in large screen colour televisions and monitors. When used in conjunction with a low voltage Power MOSFET in emitter switch configuration, they can operate at up to 100kHz.

This hollow emitter FASTSWITCH transistor is available in the metal can TO-3 package.



TO-3

ABSOLUTE MAXIMUM RATINGS

Symbol	Parameter	SGSF664	Unit
V_{CES}	Collector - Emitter Voltage ($V_{BE} = 0$)	1200	V
V_{CEO}	Collector - Emitter Voltage ($I_B = 0$)	600	V
V_{EBO}	Emitter - Base Voltage ($I_C = 0$)	7	V
I_C	Collector Current	20	A
I_{CM}	Collector Peak Current ($t_p < 5ms$)	30	A
I_B	Base Current	14	A
I_{BM}	Base Peak Current ($t_p < 5ms$)	24	A
P_{tot}	Total Dissipation at $T \leq 25^\circ C$	250	W
T_{stg}	Storage Temperature - 65 to	175	$^\circ C$
T_j	Junction Temperature	175	$^\circ C$

THERMAL DATA

$R_{thj-case}$	Thermal Resistance Junction-case	Max	0.6	°C/W
----------------	----------------------------------	-----	-----	------

ELECTRICAL CHARACTERISTICS ($T_{case} = 25^{\circ}C$ unless otherwise specified)

Symbol	Parameter	Test Conditions	Min.	Typ.	Max.	Unit
I_{CES}	Collector Cutoff Current ($V_{BE} = 0$)	$V_{CE} = 1200V$			400	μA
I_{CEO}	Collector Cutoff Current ($I_B = 0$)	$V_{CE} = 380V$ $V_{CE} = 600V$			400 4	μA mA
I_{EBO}	Emitter Cutoff Current ($I_C = 0$)	$V_{EB} = 7V$			2	mA
$V_{CEO(sus)}$ *	Collector Emitter Sustaining Voltage	$I_C = 0.2A$	600			V
$V_{CE(sat)}$ *	Collector Emitter Saturation Voltage	$I_C = 12A$ $I_B = 2.4A$ $I_C = 7A$ $I_B = 1A$			1.5 1.5	V V
$V_{BE(sat)}$ *	Base Emitter Saturation Voltage	$I_C = 12A$ $I_B = 2.4A$ $I_C = 7A$ $I_B = 1A$			1.5 1.5	V V

RESISTIVE LOAD

Symbol	Parameter	Test Conditions	Min.	Typ.	Max.	Unit
t_{on}	Turn-on Time	$I_C = 12A$ $V_{CC} = 250V$ $I_{B1} = 2.4A$ $I_{B2} = -2I_{B1}$		0.6	1.2	μs
t_s	Storage Time			2.45	3.5	μs
t_f	Fall Time			0.12	0.4	μs
t_{on}	Turn-on Time	$I_C = 12A$ $V_{CC} = 250V$ $I_{B1} = 2.4A$ $I_{B2} = -2I_{B1}$ with Antisaturation Network		0.6		μs
t_s	Storage Time			1.7		μs
t_f	Fall Time			0.12		μs
t_{on}	Turn-on Time	$I_C = 12A$ $V_{CC} = 250V$ $I_{B1} = 2.4A$ $V_{BE(off)} = -5V$		0.6		μs
t_s	Storage Time			1.3		μs
t_f	Fall Time			0.2		μs

INDUCTIVE LOAD

Symbol	Parameter	Test Conditions	Min.	Typ.	Max.	Unit
t_s	Storage Time	$I_C = 12A$ $h_{FE} = 5$ $V_{CL} = 450V$ $V_{BE(off)} = -5V$ $L = 300\mu H$ $R_{B(off)} = 0.5\Omega$		1.5	3	μs
t_f	Fall Time			0.12	0.25	μs
t_s	Storage Time	$I_C = 12A$ $h_{FE} = 5$ $V_{CL} = 450V$ $V_{BE(off)} = -5V$ $L = 300\mu H$ $R_{B(off)} = 0.5\Omega$ $T_c = 100^{\circ}C$			4.3	μs
t_f	Fall Time				0.35	μs

* Pulsed : Pulse duration = 300 μs , duty cycle = 1.5%

Safe Operating Areas

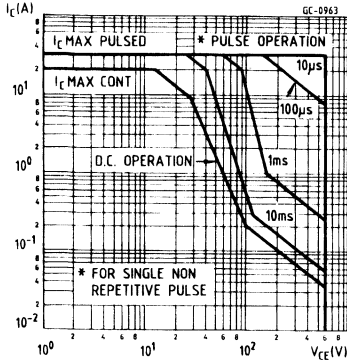

Reverse Biased Safe Operating Area

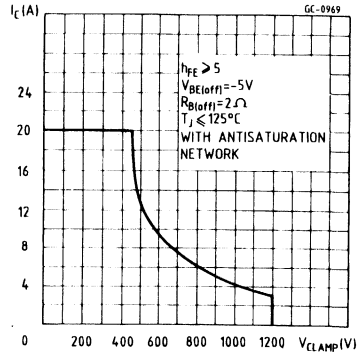

DC Current Gain

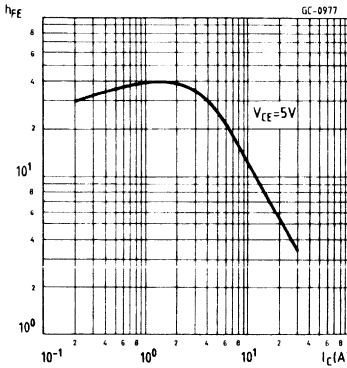

Collector-emitter Saturation Voltage

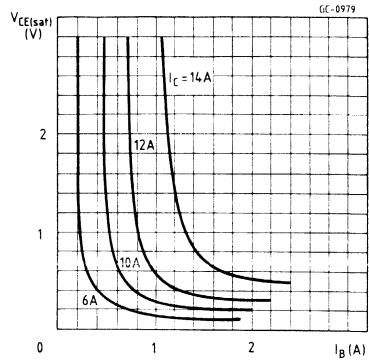

Collector-emitter Saturation Voltage

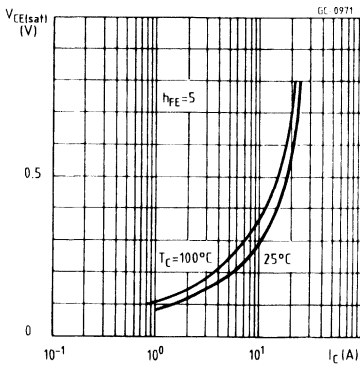

Base-emitter Saturation Voltage

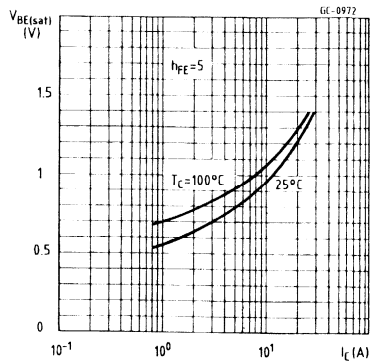

Resistive Load Switching Times

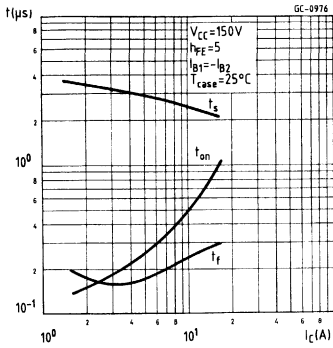

Inductive Load Switching Times

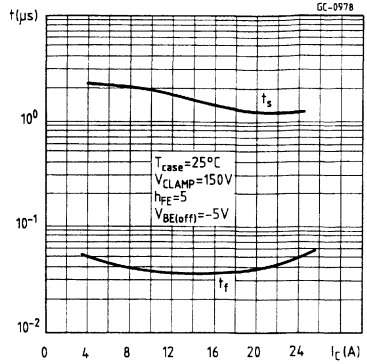

Switching Times Percentage Variation

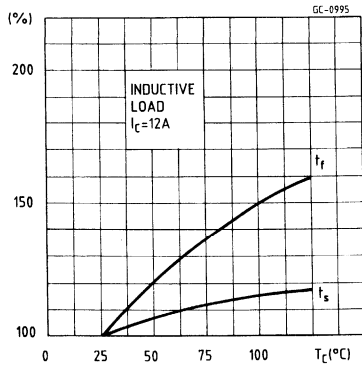

FASTSWITCH HOLLOW-EMITTER NPN TRANSISTOR

- HIGH SWITCHING SPEED NPN POWER TRANSISTOR
- HOLLOW EMITTER TECHNOLOGY
- HIGH VOLTAGE FOR OFF-LINE APPLICATIONS
- 50kHz SWITCHING SPEED
- LOW COST DRIVE CIRCUITS
- LOW DYNAMIC SATURATION

APPLICATIONS

- SMPS
- TV AND MONITOR DEFLECTION

DESCRIPTION

This hollow emitter FASTSWITCH NPN power transistor is specially designed for 220V (and 117V

with input doubler) off-line switching power supply applications. It can also be used for 117V three phase mains off-line switching power supplies. The superior switching performance reduces dissipation and consequently lowers the equipment operating temperature. This transistor is suitable for applications in half bridge and full bridge high power converters, 700W to 1500W. The high switching speed of this transistor, together with its high voltage and current rating, make it ideal for horizontal deflection circuits in large screen colour televisions and monitors. When used in conjunction with a low voltage Power MOSFET in emitter switch configuration, they can operate at up to 100kHz.

This hollow emitter FASTSWITCH transistor is available in the metal can TO-3 package.

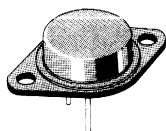

TO-3

ABSOLUTE MAXIMUM RATINGS

Symbol	Parameter	SGSF665	Unit
V_{CES}	Collector - Emitter Voltage ($V_{BE} = 0$)	1300	V
V_{CEO}	Collector - Emitter Voltage ($I_B = 0$)	600	V
V_{EBO}	Emitter - Base Voltage ($I_C = 0$)	7	V
I_C	Collector Current	20	A
I_{CM}	Collector Peak Current ($t_p < 5ms$)	30	A
I_B	Base Current	14	A
I_{BM}	Base Peak Current ($t_p < 5ms$)	24	A
P_{tot}	Total Dissipation at $T \leq 25^\circ C$	250	W
T_{stg}	Storage Temperature - 65 to	175	$^\circ C$
T_j	Junction Temperature	175	$^\circ C$

THERMAL DATA

$R_{thj-case}$	Thermal Resistance Junction-case	Max	0.6	°C/W
----------------	----------------------------------	-----	-----	------

ELECTRICAL CHARACTERISTICS ($T_{case} = 25^{\circ}C$ unless otherwise specified)

Symbol	Parameter	Test Conditions	Min.	Typ.	Max.	Unit
I_{CES}	Collector Cutoff Current ($V_{BE} = 0$)	$V_{CE} = 1300V$			400	μA
I_{CEO}	Collector Cutoff Current ($I_B = 0$)	$V_{CE} = 380V$ $V_{CE} = 600V$			400 4	μA mA
I_{EBO}	Emitter Cutoff Current ($I_C = 0$)	$V_{EB} = 7V$			2	mA
$V_{CEO(sus)^*}$	Collector Emitter Sustaining Voltage	$I_C = 0.2A$	600			V
$V_{CE(sat)^*}$	Collector Emitter Saturation Voltage	$I_C = 10A$ $I_B = 2A$ $I_C = 6A$ $I_B = 0.9A$			1.5 1.5	V V
$V_{BE(sat)^*}$	Base Emitter Saturation Voltage	$I_C = 10A$ $I_B = 2A$ $I_C = 6A$ $I_B = 0.9A$			1.5 1.5	V V

RESISTIVE LOAD

Symbol	Parameter	Test Conditions	Min.	Typ.	Max.	Unit
t_{on}	Turn-on Time	$I_C = 10A$ $V_{CC} = 250V$ $I_{B1} = 2A$ $I_{B2} = -2 I_{B1}$		0.6	1.2	μs
t_s	Storage Time			2.45	3.5	μs
t_f	Fall Time			0.12	0.4	μs
t_{on}	Turn-on Time	$I_C = 10A$ $V_{CC} = 250V$ $I_{B1} = 2A$ $I_{B2} = -2 I_{B1}$ With Antisaturation Network		0.6		μs
t_s	Storage Time			1.7		μs
t_f	Fall Time			0.12		μs
t_{on}	Turn-on Time	$I_C = 10A$ $V_{CC} = 250V$ $I_{B1} = 2A$ $V_{BE(off)} = -5V$		0.6		μs
t_s	Storage Time			1.3		μs
t_f	Fall Time			0.2		μs

INDUCTIVE LOAD

Symbol	Parameter	Test Conditions	Min.	Typ.	Max.	Unit
t_s	Storage Time	$I_C = 10A$ $h_{FE} = 5$ $V_{CL} = 450V$ $V_{BE(off)} = -5V$ $L = 300\mu H$ $R_{B(off)} = 0.5\Omega$		1.5	3	μs
t_f	Fall Time			0.12	0.25	μs
t_s	Storage Time	$I_C = 10A$ $h_{FE} = 5$ $V_{CL} = 450V$ $V_{BE(off)} = -5V$ $L = 300\mu H$ $R_{B(off)} = 0.5\Omega$ $T_C = 100^{\circ}C$			4.3	μs
t_f	Fall Time				0.35	μs

* Pulsed : Pulse duration = 300 μs , duty cycle = 1.5%

Safe Operating Areas

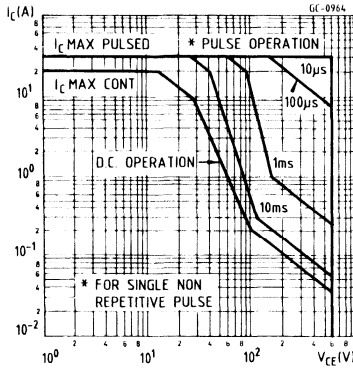

Reverse Biased Safe Operating Area

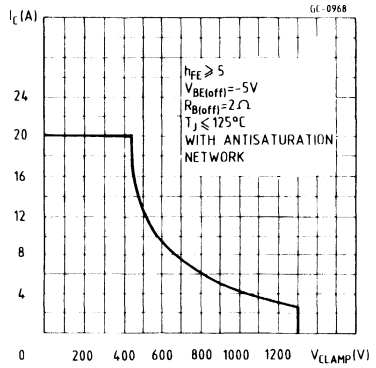

DC Current Gain

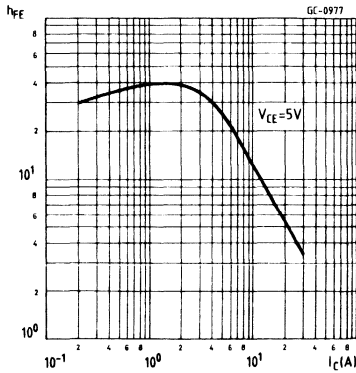

Collector-emitter Saturation Voltage

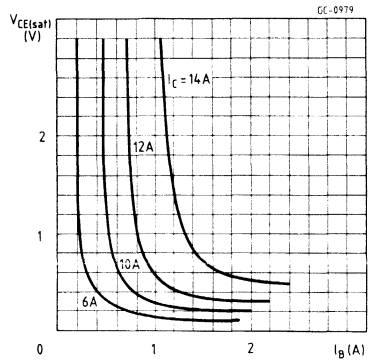

Collector-emitter Saturation Voltage

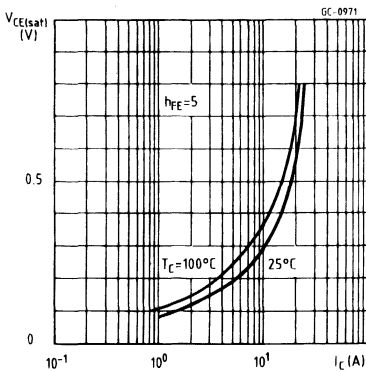

Base-emitter Saturation Voltage

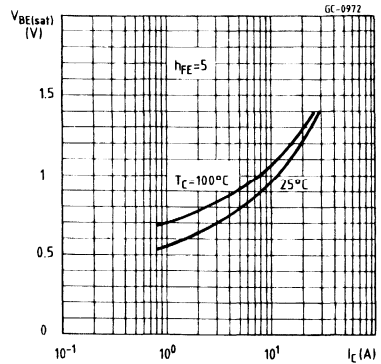

Resistive Load Switching Times

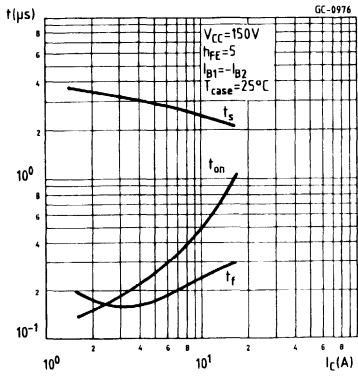

Inductive Load Switching Times

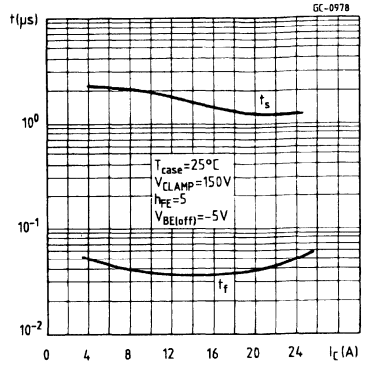

Switching Times Percentage Variation

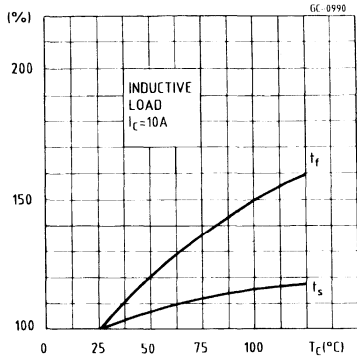

MEDIUM POWER LINEAR AND SWITCHING APPLICATIONS

DESCRIPTION

The TIP31, TIP31A, TIP31B and TIP31C are silicon epitaxial-base power NPN transistors in Jedec TO-220 plastic package, intended for use in medium power linear and switching applications. The complementary PNP types are the TIP32, TIP32A, TIP32B and TIP32C.

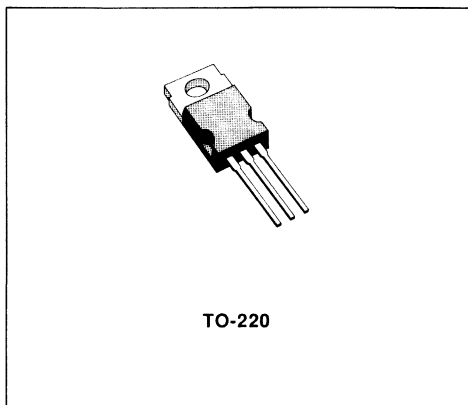

INTERNAL SCHEMATIC DIAGRAMS

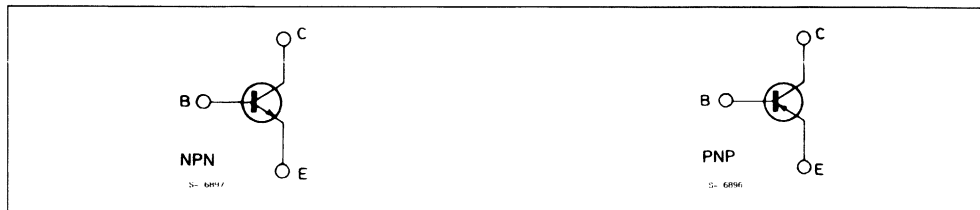

ABSOLUTE MAXIMUM RATINGS

Symbol	Parameter	NPN PNP*	Value				Unit
			TIP31 TIP32	TIP31A TIP32A	TIP31B TIP32B	TIP31C TIP32C	
V_{CBO}	Collector-base Voltage ($I_E = 0$)		40	60	80	100	V
V_{CEO}	Collector-emitter Voltage ($I_B = 0$)		40	60	80	100	V
V_{EBO}	Emitter-base Voltage ($I_C = 0$)		5				V
I_C	Collector Current		3				A
I_{CM}	Collector Peak Current		5				A
I_B	Base Current		1				A
P_{tot}	Total Power Dissipation at $T_{case} \leq 25^\circ\text{C}$ $T_{amb} \leq 25^\circ\text{C}$		40				W
			2				W
T_{stg}	Storage Temperature		- 65 to 150				$^\circ\text{C}$
T_j	Junction Temperature		150				$^\circ\text{C}$

* For PNP types voltage and current values are negative.

THERMAL DATA

$R_{th\ j\ case}$	Thermal Resistance Junction-case	Max	3.12	°C/W
$R_{th\ j\ amb}$	Thermal Resistance Junction-ambient	Max	62.5	°C/W

ELECTRICAL CHARACTERISTICS ($T_{case} = 25\text{ °C}$ unless otherwise specified)

Symbol	Parameter	Test Conditions	Min.	Typ.	Max.	Unit
I_{CEO}	Collector Cutoff Current ($I_B = 0$)	for TIP31/31A/32/32A $V_{CE} = 30\text{ V}$ for TIP31B/31C/32B/32C $V_{CE} = 60\text{ V}$			0.3	mA
I_{CES}	Collector Cutoff Current ($V_{BE} = 0$)	for TIP31/32 $V_{CE} = 40\text{ V}$ for TIP31A/32A $V_{CE} = 60\text{ V}$ for TIP31B/32B $V_{CE} = 80\text{ V}$ for TIP31C/32C $V_{CE} = 100\text{ V}$			0.2	mA
I_{EBO}	Emitter Cutoff Current ($I_C = 0$)	$V_{EB} = 5\text{ V}$			1	mA
$V_{CEO(sus)}^*$	Collector-emitter Sustaining Voltage ($I_B = 0$)	$I_C = 30\text{ mA}$ for TIP31/32 for TIP31A/32A for TIP31B/32B for TIP31C/32C	40 60 80 100			V
$V_{CE(sat)}^*$	Collector-emitter Saturation Voltage	$I_C = 3\text{ A}$ $I_B = 375\text{ mA}$			1.2	V
$V_{BE(on)}^*$	Base-emitter Voltage	$I_C = 3\text{ A}$ $V_{CE} = 4\text{ A}$			1.8	V
h_{FE}^*	DC current Gain	$I_C = 1\text{ A}$ $V_{CE} = 4\text{ V}$ $I_C = 3\text{ A}$ $V_{CE} = 4\text{ V}$	25 10		50	
h_{fe}	Small Signal Current Gain	$I_C = 0.5\text{ A}$ $f = 1\text{ KHz}$ $I_C = 0.5\text{ A}$ $f = 1\text{ MHz}$	$V_{CE} = 10\text{ V}$ $V_{CE} = 10\text{ V}$	20 3		

* Pulsed : pulse duration = 300 μs , duty cycle $\leq 2\%$.
For PNP types voltage and current values are negative.

Safe Operating Areas.

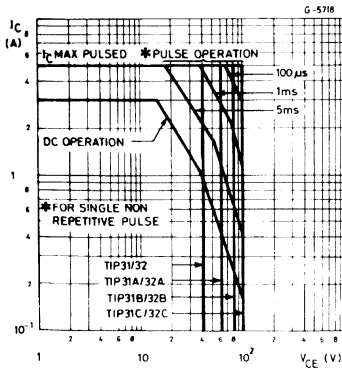

DC Current Gain (NPN types).

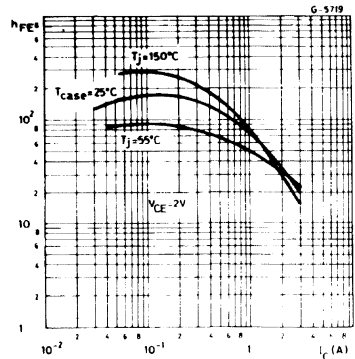

Input and Output Capacitance (NPN types).

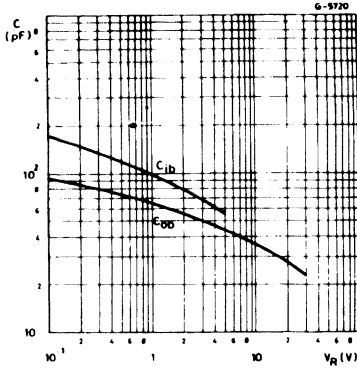

Base-emitter Voltage (NPN types).

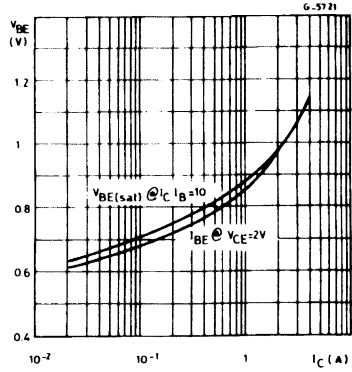

Collector-emitter Saturation Voltage (NPN types).

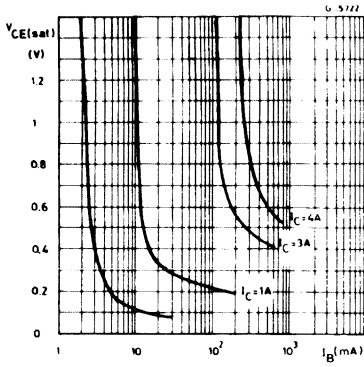

Input and Output Capacitance (PNP types).

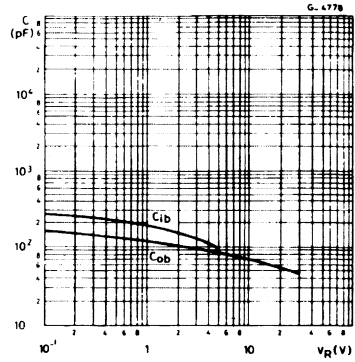

Base-emitter Voltage (PNP types).

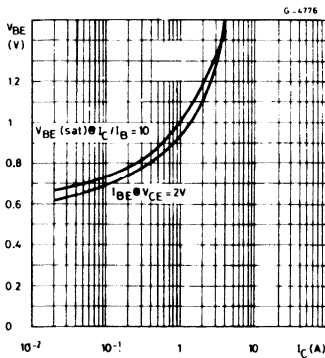

Collector-emitter Saturation Voltage (PNP types).

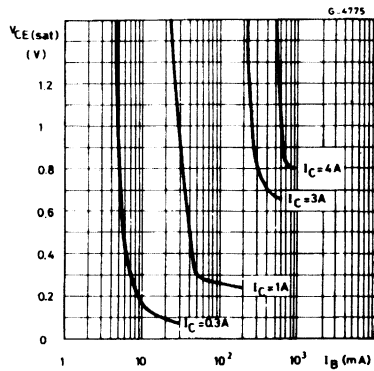

DC Current Gain (PNP types).

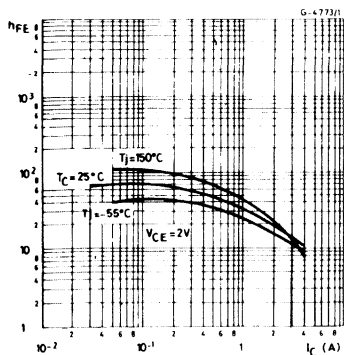

NPN MEDIUM POWER TRANSISTORS

ADVANCE DATA

- 10A RATED COLLECTOR CURRENT
- HIGH SPEED SWITCHING

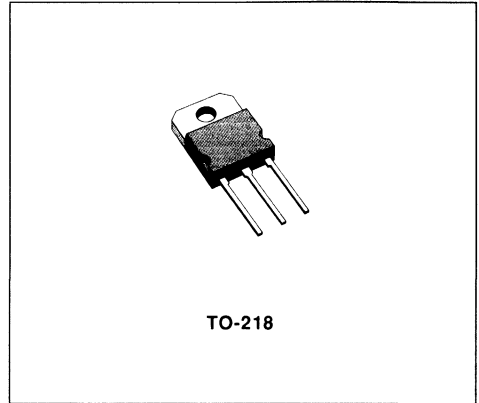

DESCRIPTION

The TIP33A, TIP33B and TIP33C are silicon epitaxial base NPN power transistors in TO-218 plastic package intended for use in linear and switching applications.

The complementary PNP types are TIP34A, TIP34B and TIP34C respectively.

INTERNAL SCHEMATIC DIAGRAM

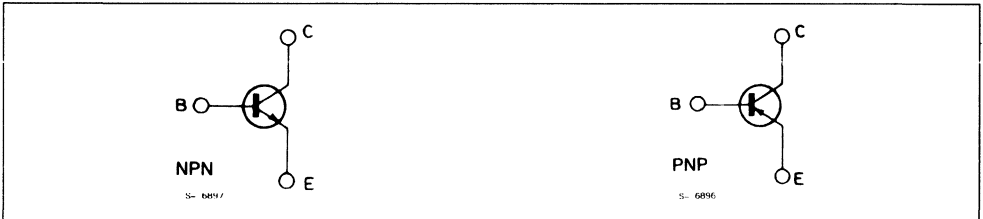

ABSOLUTE MAXIMUM RATINGS

Symbol	Parameter	NPN PNP	Value			Unit
			TIP33A TIP34A	TIP33B TIP34B	TIP33C TIP34C	
V_{CBO}	Collector-base Voltage	$I_E = 0$	100	120	140	V
V_{CES}	Collector-emitter Voltage	$V_{BE} = 0$	100	120	140	V
V_{CEO}	Collector-emitter Voltage	$I_B = 0$	60	80	100	V
V_{EBO}	Emitter-base Voltage	$I_C = 0$	7			V
I_C	Collector Current		10			A
I_{CM}	Collector Peak Current $t_p < ?ms$		12			A
I_B	Base Current		3			A
P_{tot}	Total Dissipation at $T_c < 25^\circ C$		80			W
T_{stg}	Storage Temperature		- 65 to 150			$^\circ C$
T_j	Max. Operating Junction Temperature		150			$^\circ C$

For PNP types voltage and current values are negative.

THERMAL DATA

$R_{thj-case}$	Thermal Resistance Junction-case	max	1.56	°C/W
----------------	----------------------------------	-----	------	------

ELECTRICAL CHARACTERISTICS ($T_{case} = 25^{\circ}C$ unless otherwise specified)

Symbol	Parameter	Test Conditions		Min.	Typ.	Max.	Unit
I_{CES}	Collector Cutoff Current ($V_{BE} = 0$)	$V_{CE} = 100V$ $V_{CE} = 120V$ $V_{CE} = 140V$	for TIP33A/34A for TIP33B/34B for TIP33C/34C			400 400 400	μA μA μA
I_{CEO}	Collector Cutoff Current ($I_B = 0$)	$V_{CE} = 30V$ $V_{CE} = 60V$ $V_{CE} = 60V$	for TIP33A/34A for TIP33B/34B for TIP33C/34C			0.7 0.7 0.7	mA mA mA
I_{EBO}	Emitter Cutoff Current ($I_C = 0$)	$V_{EB} = 5V$				1	mA
$V_{CEO(sus)}$ *	Collector Emitter Sustaining Voltage	$I_C = 30mA$	for TIP33A/34A for TIP33B/34B for TIP33C/34C	60 80 100			V V V
$V_{CE(sat)}$ *	Collector-emitter Saturation Voltage	$I_C = 3A$ $I_C = 10A$	$I_B = 0.3A$ $I_B = 2.5A$			1 4	V V
$V_{BE(on)}$ *	Base-emitter Voltage	$I_C = 3A$ $I_C = 10A$	$V_{CE} = 4V$ $V_{CE} = 4V$			1.6 3	V V
h_{FE}^*	DC Current Gain	$I_C = 1A$ $I_C = 3A$	$V_{CE} = 4V$ $V_{CE} = 4V$	40 20		100	
h_{fe}	Small Signal Current Gain	$I_C = 0.5A$	$V_{CE} = 10V$	$f = 1KHz$	20		
f_T	Transition Frequency	$I_C = 0.5A$	$V_{CE} = 10V$	$f = 1MHz$	3		MHz
t_{on} t_s t_f	RESISTIVE LOAD Turn-on Time Storage Time Fall Time	$V_{CC} = 30V$ $V_{BB} = -6V$ $t_p = 20\mu s$	$I_C = 6A$ $I_{B1} = - I_{B2} = 0.6A$			0.6 0.4 1	μs μs μs

* Pulsed : pulse duration = 300 μs , duty cycle = 1.5%.

For PNP types voltage and current values are negative.

POWER AMPLIFIER AND SWITCHING APPLICATIONS

ADVANCE DATA

DESCRIPTION

The TIP35/TIP35A/TIP35B/TIP35C are silicon epitaxial-base NPN transistors in SOT-93 plastic package. They are intended for power amplifier and switching applications. The complementary PNP types are the TIP36/TIP36A/TIP36B/TIP36C.

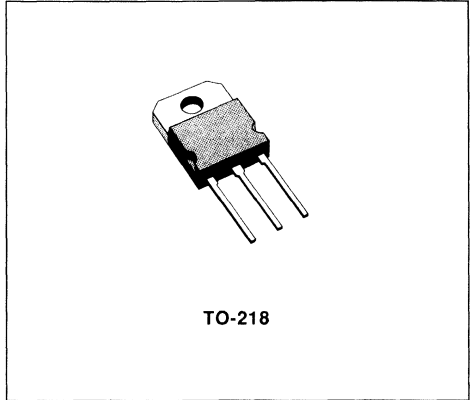

INTERNAL SCHEMATIC DIAGRAMS

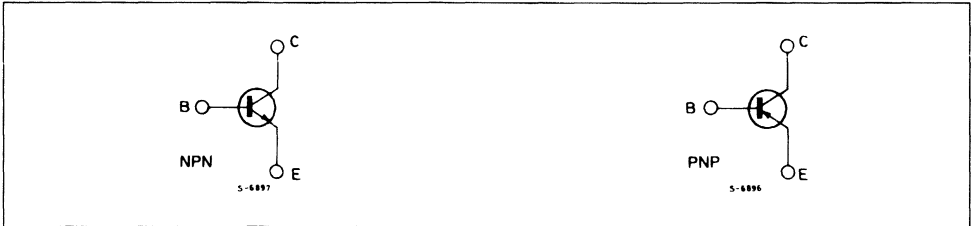

ABSOLUTE MAXIMUM RATINGS

Symbol	Parameter	PNP* NPN	Value				Unit
			TIP36 TIP35	TIP36A TIP35A	TIP36B TIP35B	TIP36C TiP35C	
V_{CE0}	Collector-emitter Voltage ($I_B = 0$)		40	60	80	100	V
V_{CB0}	Collector-base Voltage ($I_E = 0$)		40	60	80	100	V
V_{EB0}	Emitter-base Voltage ($I_C = 0$)		5				V
I_C	Collector Current		25				A
I_{CM}	Collector Peak Current		50				A
I_B	Base Current		5				A
P_{tot}	Total Power Dissipation at $T_{case} \leq 25^\circ\text{C}$		125				W
T_{stg}	Storage Temperature		- 65 to 150				$^\circ\text{C}$
T_j	Junction Temperature		150				$^\circ\text{C}$

* For PNP types voltage and current values are negative.

THERMAL DATA

$R_{th\ j-case}$	Thermal Resistance Junction-case	Max	1	°C/W
------------------	----------------------------------	-----	---	------

ELECTRICAL CHARACTERISTICS ($T_{case} = 25\text{ °C}$ unless otherwise specified)

Symbol	Parameter	Test Conditions	Min.	Typ.	Max.	Unit
I_{CEO}	Collector Cutoff Current ($I_B = 0$)	for TIP35/35A/36/36A $V_{CE} = 30\text{ V}$ for TIP35B/35C/36B/36C $V_{CE} = 60\text{ V}$			1	mA
I_{EBO}	Emitter Cutoff Current ($V_{BE} = 0$)	$V_{EB} = 5\text{ V}$			1	mA
I_{CES}	Collector Cutoff Current ($V_{BE} = 0$)	$V_{CE} = \text{Rated } V_{CEO}$			0.7	mA
$V_{CEO(sus)}^*$	Collector-emitter Sustaining Voltage	$I_C = 30\text{ mA}$ for TIP35/36 for TIP35A/36A for TIP35B/36B for TIP35C/36C	40 60 80 100			V V V V
h_{FE}^*	DC current Gain	$I_C = 1.5\text{ A}$ $V_{CE} = 4\text{ V}$ $I_C = 15\text{ A}$ $V_{CE} = 4\text{ V}$	25 10		50	
$V_{CE(sat)}^*$	Collector-emitter Saturation Voltage	$I_C = 15\text{ A}$ $I_B = 1.5\text{ A}$ $I_C = 25\text{ A}$ $I_B = 5\text{ A}$			1.8 4	V V
$V_{BE(on)}^*$	Base-emitter on Voltage	$I_C = 15\text{ A}$ $V_{CE} = 4\text{ V}$ $I_C = 25\text{ A}$ $V_{CE} = 4\text{ V}$			2 4	V V
f_T	Transition Frequency	$I_C = 1\text{ A}$ $V_{CE} = 10\text{ V}$ $f = 1\text{ MHz}$	3			MHz
h_{fe}	Small Signal Current Gain	$I_C = 1\text{ A}$ $V_{CE} = 10\text{ V}$ $f = 1\text{ KHz}$	25			

* Pulsed : pulse duration $\leq 300\text{ }\mu\text{s}$, duty cycle $\leq 2\%$.
For PNP types voltage and current values are negative.

MEDIUM POWER LINEAR AND SWITCHING APPLICATIONS

DESCRIPTION

The TIP41, TIP41A, TIP41B and TIP41C are silicon epitaxial-base NPN power transistors in Jedec TO-220 plastic package intended for use in medium power linear and switching applications. The complementary PNP types are the TIP42, TIP42A, TIP42B and TIP42C respectively.

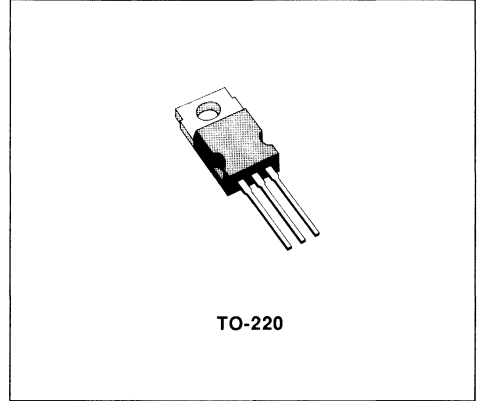

INTERNAL SCHEMATIC DIAGRAMS

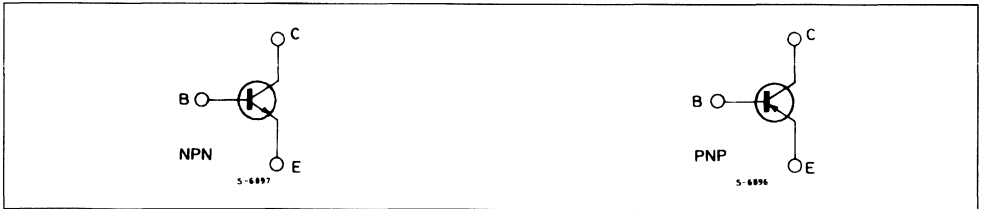

ABSOLUTE MAXIMUM RATINGS

Symbol	Parameter	NPN PNP*	Value				Unit
			TIP41 TIP42	TIP41A TIP42A	TIP41B TIP42B	TIP41C TIP42C	
V_{CBO}	Collector-base Voltage ($I_E = 0$)		40	60	80	100	V
V_{CEO}	Collector-emitter Voltage ($I_B = 0$)		40	60	80	100	V
V_{EBO}	Emitter-base Voltage ($I_C = 0$)		5				V
I_C	Collector Current		6				A
I_{CM}	Collector Peak Current		10				A
I_B	Base Current		3				A
P_{tot}	Total Power Dissipation at $T_{case} \leq 25^\circ\text{C}$ $T_{amb} \leq 25^\circ\text{C}$		65				W
T_{stg}	Storage Temperature		- 65 to 150				$^\circ\text{C}$
T_j	Junction Temperature		150				$^\circ\text{C}$

* For PNP types voltage and current values are negative.

THERMAL DATA

$R_{th\ j-case}$	Thermal Resistance Junction-case	Max	1.92	°C/W
$R_{th\ j-amb}$	Thermal Resistance Junction-ambient	Max	62.5	°C/W

ELECTRICAL CHARACTERISTICS ($T_{case} = 25\text{ °C}$ unless otherwise specified)

Symbol	Parameter	Test Conditions	Min.	Typ.	Max.	Unit	
I_{CEO}	Collector Cutoff Current ($I_B = 0$)	for TIP41/41A/42/42A $V_{CE} = 30\text{ V}$			0.7	mA	
		for TIP41B/41C/42B/42C $V_{CE} = 60\text{ V}$			0.7	mA	
I_{CES}	Collector Cutoff Current ($V_{BE} = 0$)	for TIP41/42 $V_{CE} = 40\text{ V}$			0.4	mA	
		for TIP41A/42A $V_{CE} = 60\text{ V}$			0.4	mA	
		for TIP41B/42B $V_{CE} = 80\text{ V}$			0.4	mA	
		for TIP41C/42C $V_{CE} = 100\text{ V}$			0.4	mA	
I_{EBO}	Emitter Cutoff Current ($I_C = 0$)	$V_{EB} = 5\text{ V}$			1	mA	
$V_{CEO(sus)}^*$	Collector-emitter Sustaining Voltage ($I_B = 0$)	$I_C = 30\text{ mA}$ for TIP41/42				V	
		for TIP41A/42A	40			V	
		for TIP41B/42B	60			V	
		for TIP41C/42C	80			V	
$V_{CE(sat)}^*$	Collector-emitter Saturation Voltage	$I_C = 6\text{ A}$				V	
		$I_B = 0.6\text{ A}$			1.5	V	
V_{BE}^*	Base-emitter Voltage	$I_C = 6\text{ A}$ $V_{CE} = 4\text{ V}$			2	V	
h_{FE}^*	DC current Gain	$I_C = 0.3\text{ A}$ $V_{CE} = 4\text{ V}$	30		75		
		$I_C = 3\text{ A}$ $V_{CE} = 4\text{ V}$	15				
h_{fe}	Small Signal Current Gain	$I_C = 0.5\text{ A}$					
		$f = 1\text{ KHz}$	20				
		$f = 1\text{ MHz}$	3				

* Pulsed : pulse duration = 300 μs , duty cycle $\leq 2\%$.
For PNP types voltage and current values are negative.

LINEAR AND SWITCHING APPLICATIONS

DESCRIPTION

The TIP47 to TIP50 are silicon multi-epitaxial planar transistors in TO-220 plastic package intended for linear and switching applications.

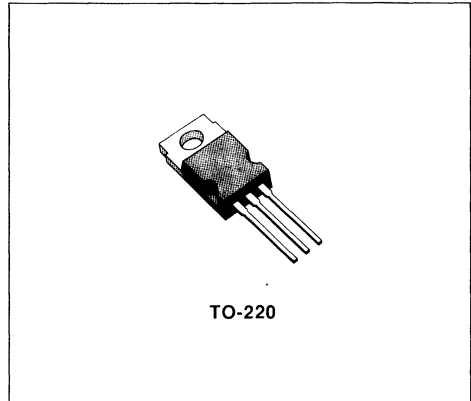

INTERNAL SCHEMATIC DIAGRAM

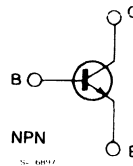

ABSOLUTE MAXIMUM RATINGS

Symbol	Parameter	Value				Unit
		TIP47	TIP48	TIP49	TIP50	
V_{CBO}	Collector-base Voltage ($I_E = 0$)	350	400	450	500	V
V_{CEO}	Collector-emitter Voltage ($I_B = 0$)	250	300	350	400	V
V_{EBO}	Emitter-base Voltage ($I_C = 0$)	5				V
I_C	Collector Current	1				A
I_{CM}	Collector Peak Current	2				A
I_B	Base Current	0.6				A
P_{tot}	Total Power Dissipation at $T_{case} \leq 25^\circ\text{C}$	40				W
P_{tot}	Total Power Dissipation at $T_{amb} \leq 25^\circ\text{C}$	2				W
T_{stg}	Storage Temperature	- 65 to 150				$^\circ\text{C}$
T_j	Junction Temperature	150				$^\circ\text{C}$

THERMAL DATA

$R_{th(j-case)}$	Thermal Resistance Junction-case	Max	3.125	C/W
$R_{th(j-amb)}$	Thermal Resistance Junction-ambient	Max	62.5	C/W

ELECTRICAL CHARACTERISTICS ($T_{case} = 25\text{ }^{\circ}\text{C}$ unless otherwise specified)

Symbol	Parameter	Test Conditions		Min.	Typ.	Max.	Unit
I_{CES}	Collector Cutoff Current ($V_{BE} = 0$)	for TIP47 for TIP48 for TIP49 for TIP50	$V_{CE} = 350\text{ V}$ $V_{CE} = 400\text{ V}$ $V_{CE} = 450\text{ V}$ $V_{CE} = 500\text{ V}$			1	mA
I_{CEO}	Collector Cutoff Current ($I_B = 0$)	for TIP47 for TIP48 for TIP49 for TIP50	$V_{CE} = 150\text{ V}$ $V_{CE} = 200\text{ V}$ $V_{CE} = 250\text{ V}$ $V_{CE} = 300\text{ V}$			1	mA
I_{EBO}	Emitter Cutoff Current ($I_C = 0$)	$V_{EB} = 5\text{ V}$				1	mA
$V_{CEO(sus)}^*$	Collector-emitter Sustaining Voltage	$I_C = 30\text{ mA}$	for TIP47 for TIP48 for TIP49 for TIP50	250 300 350 400			V
$V_{CE(sat)}^*$	Collector-emitter Saturation Voltage	$I_C = 1\text{ A}$	$I_B = 0.2\text{ A}$			1	V
$V_{BE(on)}^*$	Base-emitter on Voltage	$I_C = 1\text{ A}$	$V_{CE} = 10\text{ V}$			1.5	V
h_{FE}^*	DC current Gain	$I_C = 0.3\text{ A}$ $I_C = 1\text{ A}$	$V_{CE} = 10\text{ V}$ $V_{CE} = 10\text{ V}$	30 10		150	
f_T	Transition Frequency	$V_{CE} = 10\text{ V}$ $f = 2\text{ MHz}$	$I_C = 0.2\text{ A}$	10			MHz
h_{fe}	Small Signal Current Gain	$V_{CE} = 10\text{ V}$ $f = 1\text{ KHz}$	$I_C = 0.2\text{ A}$	25			

* Pulsed : pulse duration = 300 μs , duty cycle $\leq 2\%$.

Safe Operating Areas.

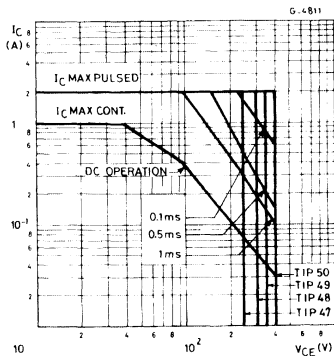

DC Current Gain.

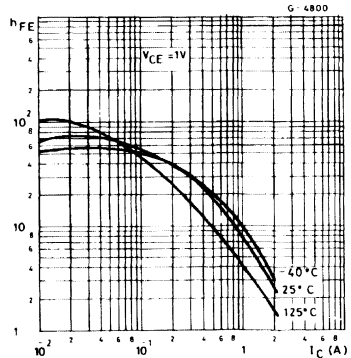

DC Current Gain.

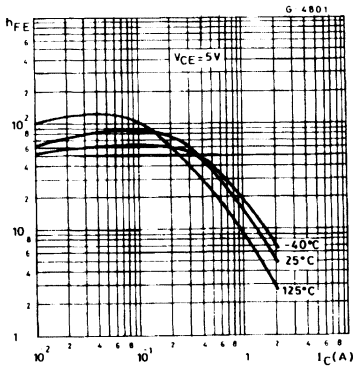

Collector-emitter Saturation Voltage.

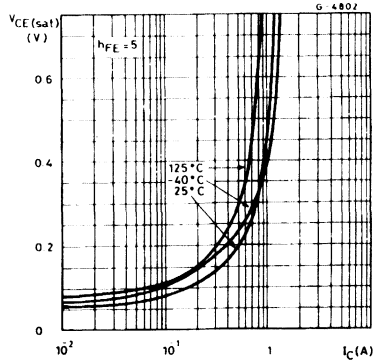

Collector-emitter Saturation Voltage.

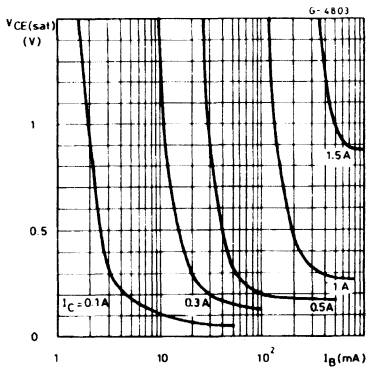

Base-emitter Saturation Voltage.

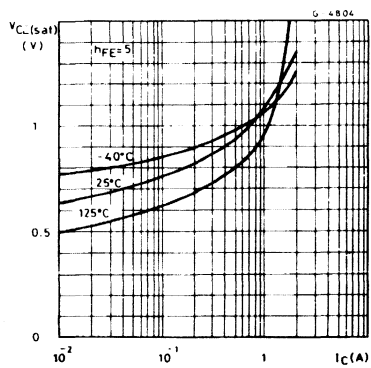

Collector-base capacitance.

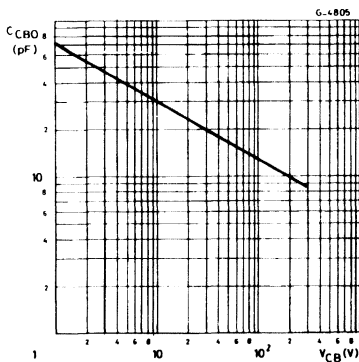

Saturated Switching Characteristics (inductive load).

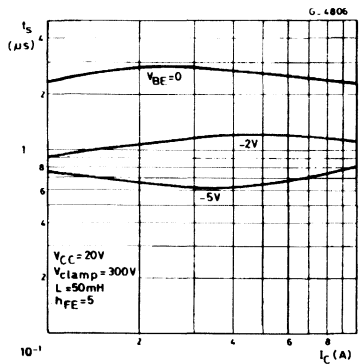

Saturated Switching Characteristics
(inductive load).

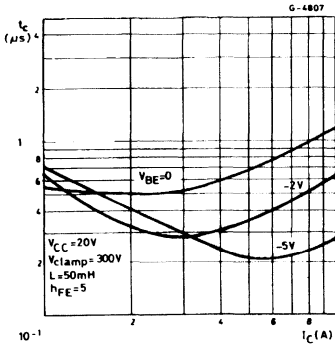

Saturated Switching Characteristics
(inductive load).

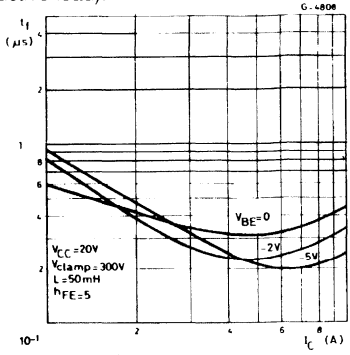

Saturated Switching Characteristics
(resistive load).

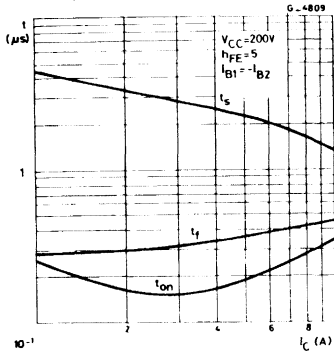

Camped Reverse Bias Safe Operating Areas.

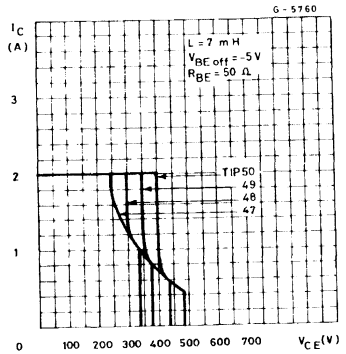

HIGH VOLTAGE POWER SWITCH

DESCRIPTION

The TIP51, TIP52, TIP53 and TIP54 are silicon multi-epitaxial mesa NPN transistors in SOT-93 plastic package.

They are intended for high voltage, fast switching industrial and consumer applications.

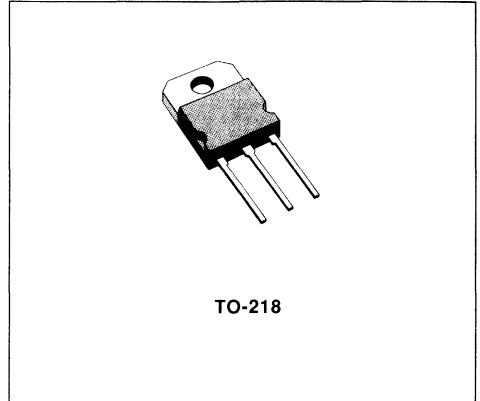

INTERNAL SCHEMATIC DIAGRAM

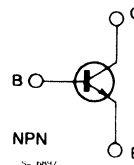

ABSOLUTE MAXIMUM RATINGS

Symbol	Parameter	Value				Unit
		TIP51	TIP52	TIP53	TIP54	
V_{CES}	Collector-emitter Voltage ($V_{BE} = 0$)	350	400	450	500	V
V_{CEO}	Collector-emitter Voltage ($I_B = 0$)	250	300	350	400	V
V_{EBO}	Emitter-base Voltage ($I_C = 0$)	5				V
I_C	Collector Current	3				A
I_{CM}	Collector Peak Current	5				A
I_B	Base Current	0.6				A
P_{tot}	Total Power Dissipation at $T_{case} \leq 25^\circ\text{C}$	100				W
T_{stg}	Storage Temperature	- 65 to 150				$^\circ\text{C}$
T_j	Junction Temperature	150				$^\circ\text{C}$

THERMAL DATA

$R_{th(j-case)}$	Thermal Resistance Junction-case	Max	1.25	°C/W
------------------	----------------------------------	-----	------	------

ELECTRICAL CHARACTERISTICS ($T_{case} = 25\text{ °C}$ unless otherwise specified)

Symbol	Parameter	Test Conditions		Min.	Typ.	Max.	Unit
I_{CES}	Collector Cutoff Current ($V_{BE} = 0$)	for TIP51 for TIP52 for TIP53 for TIP54	$V_{CE} = 350\text{ V}$ $V_{CE} = 400\text{ V}$ $V_{CE} = 450\text{ V}$ $V_{CE} = 500\text{ V}$			1 1 1 1	mA mA mA mA
I_{CEO}	Collector Cutoff Current ($I_B = 0$)	for TIP51 for TIP52 for TIP53 for TIP54	$V_{CE} = 150\text{ V}$ $V_{CE} = 200\text{ V}$ $V_{CE} = 250\text{ V}$ $V_{CE} = 300\text{ V}$			1 1 1 1	mA mA mA mA
I_{EBO}	Emitter Cutoff Current ($I_C = 0$)	$V_{EB} = 5\text{ V}$				1	mA
$V_{CE0(sus)}^*$	Collector-emitter Sustaining Voltage ($I_B = 0$)	$I_C = 30\text{ mA}$	for TIP51 for TIP52 for TIP53 for TIP54	250 300 350 400			V V V V
$V_{CE(sat)}^*$	Collector-emitter Saturation Voltage	$I_C = 3\text{ A}$	$I_B = 0.6\text{ A}$			1.5	V
V_{BE}^*	Base-emitter	$I_C = 3\text{ A}$	$V_{CE} = 10\text{ V}$			1.5	V
h_{FE}^*	DC current Gain	$I_C = 0.3\text{ A}$ $I_C = 3\text{ A}$	$V_{CE} = 10\text{ V}$ $V_{CE} = 10\text{ V}$	30 10		150	
h_{fe}	Small Signal Current Gain	$I_C = 0.2\text{ A}$; $V_{CE} = 10\text{ V}$; $f = 1\text{ KHz}$ $I_C = 0.2\text{ A}$; $V_{CE} = 10\text{ V}$; $f = 1\text{ MHz}$		30 2.5			
$E_{s/b}$	Second Breakdown Unclamped Energy	$V_{BE} = 20\text{ V}$ $L = 30\text{ mH}$	$R_{BE} = 100\text{ }\Omega$	100			mJ
t_{on}	Turn-on Time	$I_C = 1\text{ A}$ $V_{CC} = 200\text{ V}$	$I_{B1} = 100\text{ mA}$		0.2		μs
t_{off}	Turn-off Time	$I_C = 1\text{ A}$ $V_{CC} = 200\text{ V}$	$I_{B1} = -I_{B2} = 100\text{ mA}$		2		μs

* Pulsed : pulse duration = 300 μs , duty cycle = 1.5 %.

Safe Operating Areas.

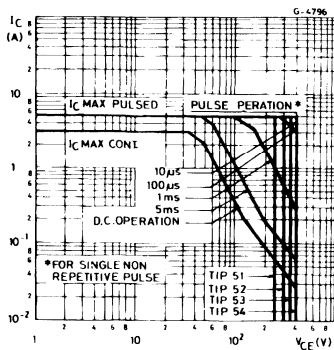

POWER DARLINGTONS
DESCRIPTION

The TIP100, TIP101 and TIP102 are silicon epitaxial-base NPN transistors in monolithic Darlington configuration mounted in Jedec TO-220 plastic package, intended for use in power linear and switching applications. The complementary PNP types are the TIP105, TIP106 and TIP107 respectively.

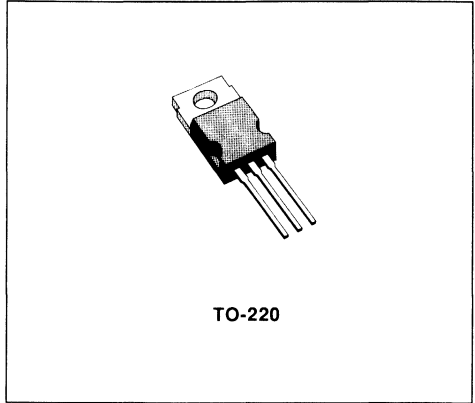
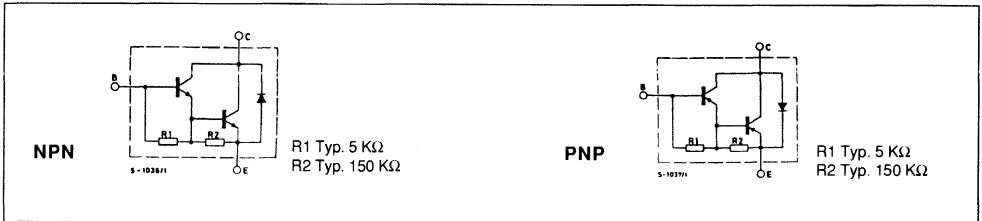
INTERNAL SCHEMATIC DIAGRAMS

ABSOLUTE MAXIMUM RATINGS

Symbol	Parameter	NPN PNP*	Value			Unit
			TIP100 TIP105	TIP101 TIP106	TIP101 TIP107	
V _{CBO}	Collector-base Voltage (I _E = 0)		60	80	100	V
V _{CEO}	Collector-emitter Voltage (I _B = 0)		60	80	100	V
V _{EBO}	Emitter-base Voltage (I _C = 0)		5			V
I _C	Collector Current		8			A
I _{CM}	Collector Peak Current		15			A
I _B	Base Current		1			A
P _{tot}	Total Power Dissipation at T _{case} ≤ 25 °C T _{amb} ≤ 25 °C		80			W
			2			W
T _{stg}	Storage Temperature		- 65 to 150			°C
T _j	Junction Temperature		150			°C

* For PNP types voltage and current values are negative.

THERMAL DATA

$R_{th\ j-case}$	Thermal Resistance Junction-case	Max	1.56	°C/W
$R_{th\ j-amb}$	Thermal Resistance Junction-ambient	Max	62.5	°C/W

ELECTRICAL CHARACTERISTICS ($T_{case} = 25\text{ °C}$ unless otherwise specified)

Symbol	Parameter	Test Conditions	Min.	Typ.	Max.	Unit
I_{CEO}	Collector Cutoff Current ($I_B = 0$)	for TIP100/105 $V_{CE} = 30\text{ V}$ for TIP101/106 $V_{CE} = 40\text{ V}$ for TIP102/107 $V_{CE} = 50\text{ V}$			50 50 50	μA μA μA
I_{CBO}	Collector Cutoff Current ($I_E = 0$)	for TIP100/105 $V_{CB} = 60\text{ V}$ for TIP101/106 $V_{CB} = 80\text{ V}$ for TIP102/107 $V_{CB} = 100\text{ V}$			50 50 50	μA μA μA
I_{EBO}	Emitter Cutoff Current ($I_C = 0$)	$V_{EB} = 5\text{ V}$			8	mA
$V_{CEO(sus)}^*$	Collector-emitter Sustaining Voltage ($I_B = 0$)	$I_C = 30\text{ mA}$ for TIP100/105 for TIP101/106 for TIP102/107	60 80 100			V V V
$V_{CE(sat)}^*$	Collector-emitter Saturation Voltage	$I_C = 3\text{ A}$ $I_B = 6\text{ mA}$ $I_C = 8\text{ A}$ $I_B = 80\text{ mA}$			2 2.5	V V
V_{BE}^*	Base-emitter Voltage	$I_C = 8\text{ A}$ $V_{CE} = 4\text{ V}$			2.8	V
h_{FE}^*	DC current Gain	$I_C = 3\text{ A}$ $V_{CE} = 4\text{ V}$ $I_C = 8\text{ A}$ $V_{CE} = 4\text{ V}$	1000 200		20000	
V_F^*	Forward Voltage of Commutation Diode ($I_B = 0$)	$I_F = -I_C = 10\text{ A}$			2.8	V

* Pulsed : pulse duration = 300 μs , duty cycle $\leq 2\%$.
For PNP types voltage and current values are negative.

Safe Operating Areas.

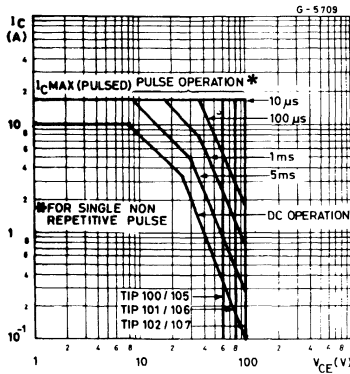

DC Current Gain (NPN types).

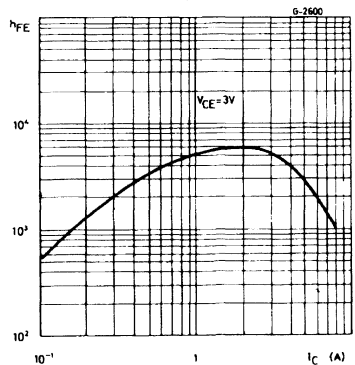

Collector-emitter Saturation Voltage (NPN types).

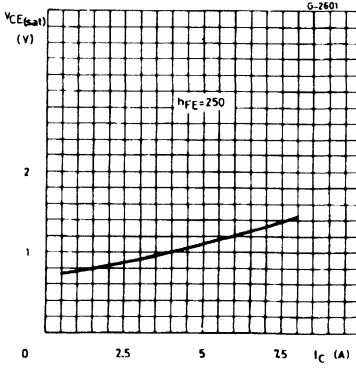

DC Transconductance (NPN types).

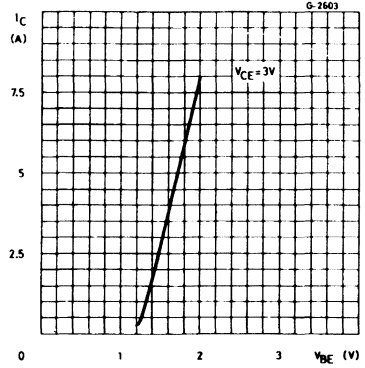

Collector-emitter Saturation Voltage (NPN types).

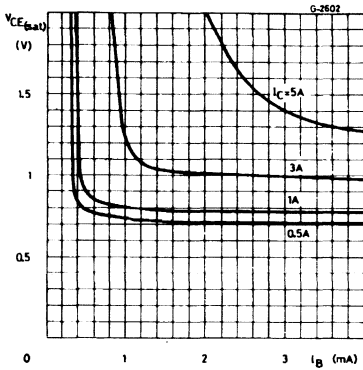

Saturated Switching Characteristics (NPN types).

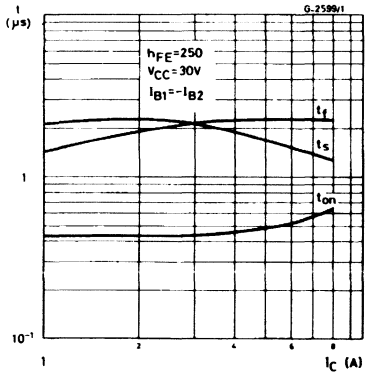

Small Signal Current Gain (NPN types).

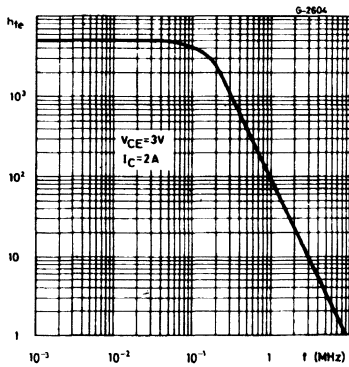

Collector-base Capacitance (PNP types).

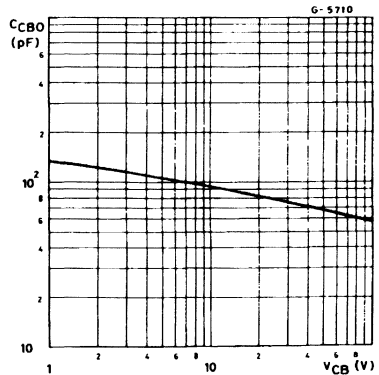

Small Signal Current Gain (PNP types).

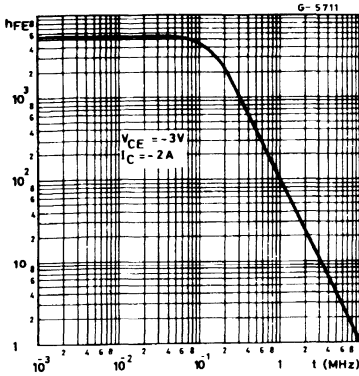

Collector-emitter Saturation Voltage (PNP types).

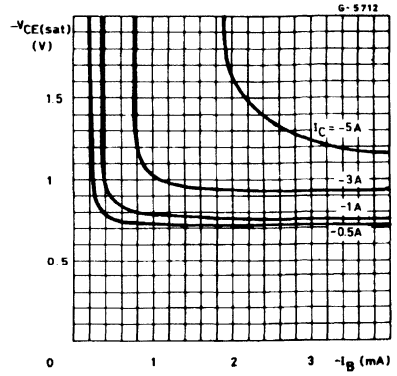

Collector-emitter Saturation Voltage (PNP types).

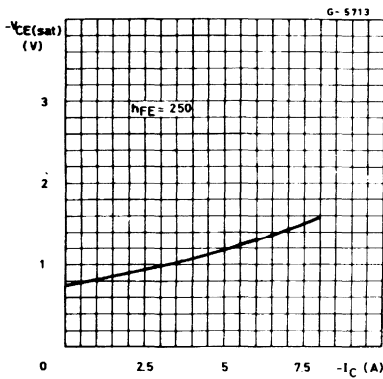

DC Current Gain (PNP types).

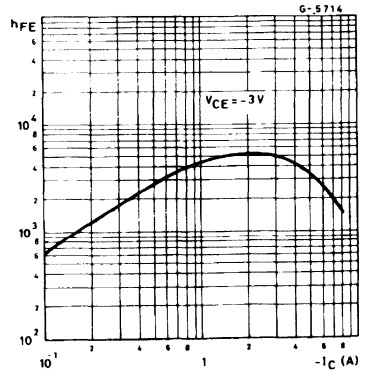

DC Transconductance (PNP types).

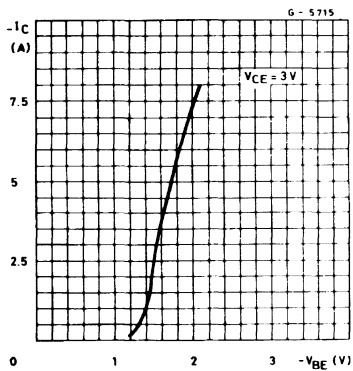

Saturated Switching Characteristics (PNP types).

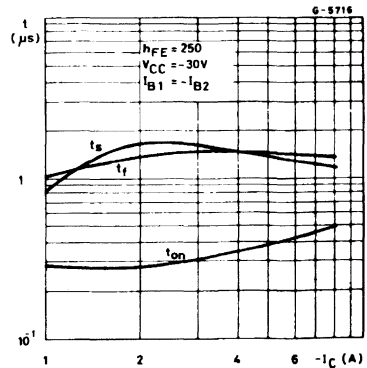

Collector-base Capacitance (NPN types).

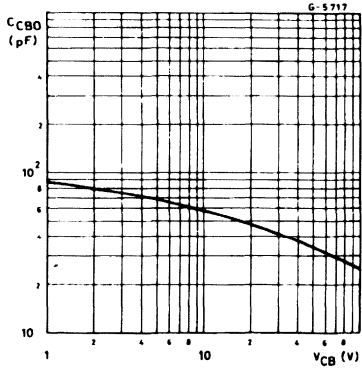

POWER DARLINGTONS

DESCRIPTION

The TIP110, TIP111, TIP112 and SGS110, SGS111, SGS112 are silicon epitaxial-base NPN transistors in monolithic Darlington configuration respectively in TO-220 and SOT-82 plastic package. They are intended for use in medium power linear and switching applications. The complementary PNP types are the TIP115, TIP116, TIP117 and SGS115, SGS116, SGS117 respectively.

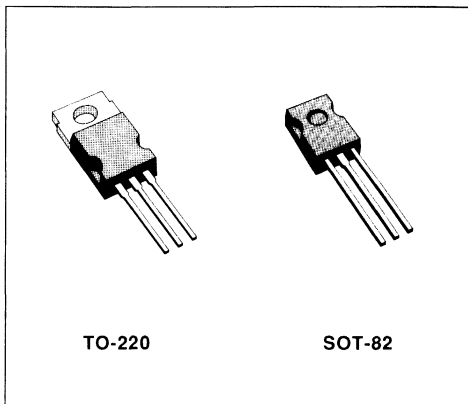

INTERNAL SCHEMATIC DIAGRAMS



ABSOLUTE MAXIMUM RATINGS

Symbol	Parameter	NPN NPN PNP PNP	Value			Unit
			TIP110 SGS110	TIP111 SGS111	TIP112 SGS112	
V_{CBO}	Collector-base Voltage ($I_E = 0$)		60	80	100	V
V_{CEO}	Collector-emitter Voltage ($I_B = 0$)		60	80	100	V
V_{EBO}	Emitter-base Voltage ($I_C = 0$)		5			V
I_C	Collector Current		2			A
I_{CM}	Collector Peak Current		4			A
I_B	Base Current		50			mA
P_{tot}	Total Power Dissipation at $T_{case} \leq 25^\circ\text{C}$ $T_{amb} \leq 25^\circ\text{C}$		50			W
			2			W
T_{stg}	Storage Temperature		- 65 to 150			$^\circ\text{C}$
T_j	Junction Temperature		150			$^\circ\text{C}$

For PNP types voltage and current values are negative.

THERMAL DATA

$R_{th\ j-case}$	Thermal Resistance Junction-case	Max	2.5	°C/W
$R_{th\ j-amb}$	Thermal Resistance Junction-ambient	Max	62.5	°C/W

ELECTRICAL CHARACTERISTICS ($T_{case} = 25\text{ °C}$ unless otherwise specified)

Symbol	Parameter	Test Conditions		Min.	Typ.	Max.	Unit
I_{CEO}	Collector Cutoff Current ($I_B = 0$)	$V_{CE} = \text{Half Rated } V_{CE0}$				2	mA
I_{CBO}	Collector Cutoff Current ($I_E = 0$)	$V_{CB} = \text{Rated } V_{CBO}$				1	mA
I_{EBO}	Emitter Cutoff Current ($I_C = 0$)	$V_{EB} = 5\text{ V}$				2	mA
$V_{CE0(sus)}^*$	Collector-emitter Sustaining Voltage ($I_B = 0$)	$I_C = 30\text{ mA}$ for TIP/SGS110 and TIP/SGS115 for TIP/SGS111 and TIP/SGS116 for TIP/SGS112 and TIP/SGS117		60 80 100			V V V
$V_{CE(sat)}^*$	Collector-emitter Saturation Voltage	$I_C = 2\text{ A}$	$I_B = 8\text{ mA}$			2.5	V
V_{BE}^*	Base-emitter Voltage	$I_C = 2\text{ A}$	$V_{CE} = 4\text{ V}$			2.8	V
h_{FE}^*	DC current Gain	$I_C = 1\text{ A}$ $I_C = 2\text{ A}$	$V_{CE} = 4\text{ V}$ $V_{CE} = 4\text{ V}$	1000 500			

* Pulsed : pulse duration = 300 μs , duty cycle $\leq 2\%$.
For PNP types voltage and current values are negative.

Safe Operating Areas.

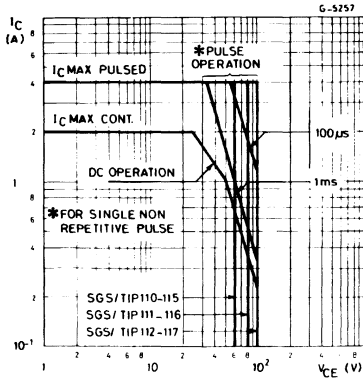

DC Current Gain (NPN types).

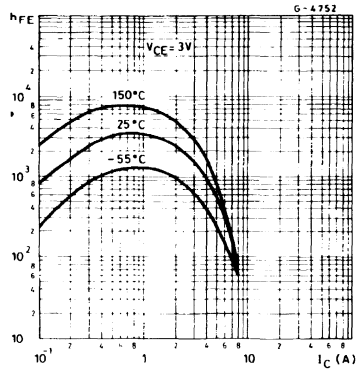

DC Current Gain (NPN types).

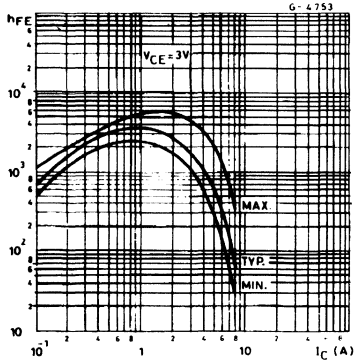

DC Current Gain (PNP types).

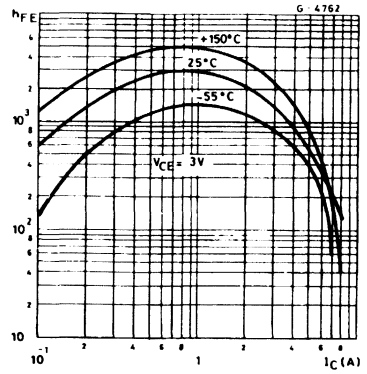

DC Current Gain (PNP types).

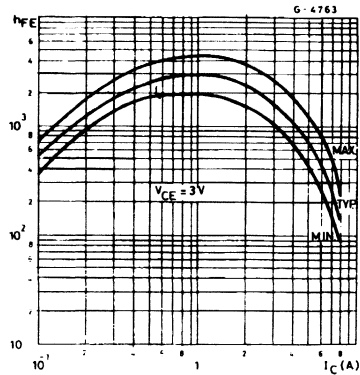

Base-emitter Voltage (NPN types).

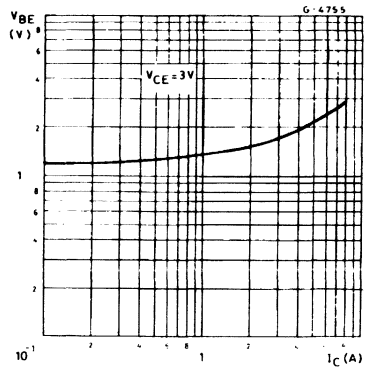

Base-emitter Saturation Voltage (NPN types).

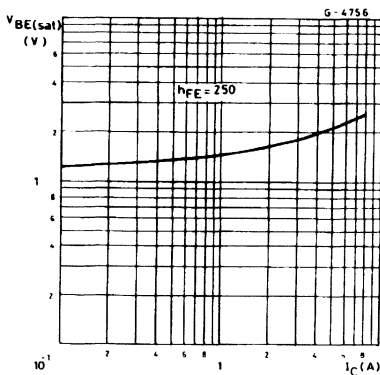

Base-emitter Voltage (PNP types).

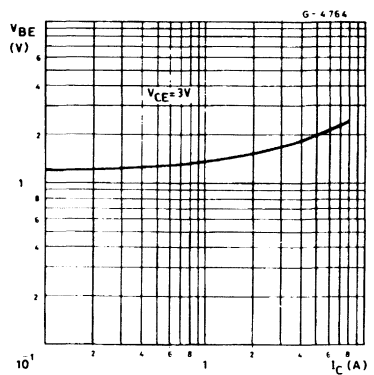

Base-emitter Saturation Voltage (PNP types).

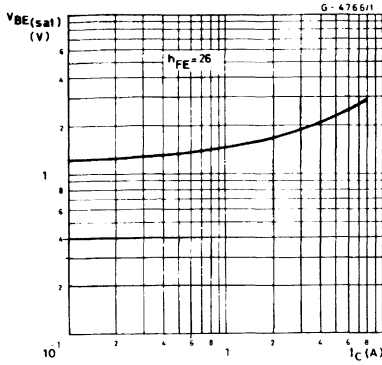

Collector-emitter Saturation Voltage (NPN types).

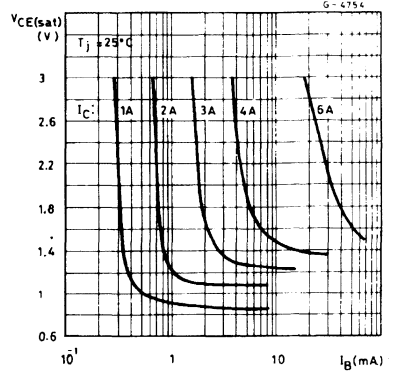

Collector-emitter Saturation Voltage (NPN types).

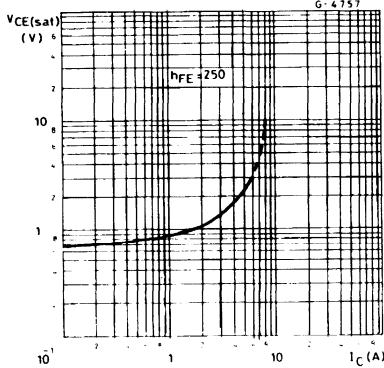

Collector-emitter Saturation Voltage (PNP types).

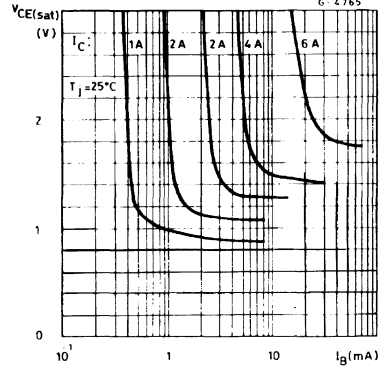

Collector-emitter Saturation Voltage (PNP types).

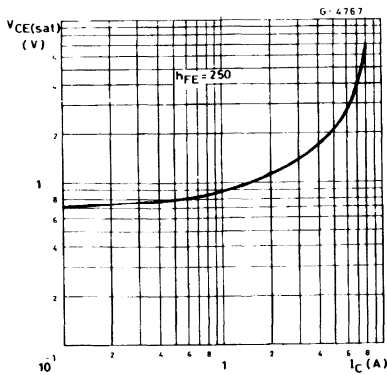

Collector Cutoff Current (NPN types).

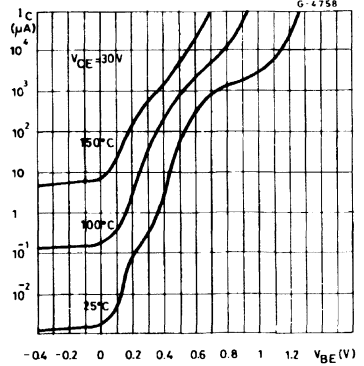

Collector Cutoff Current (NPN types).

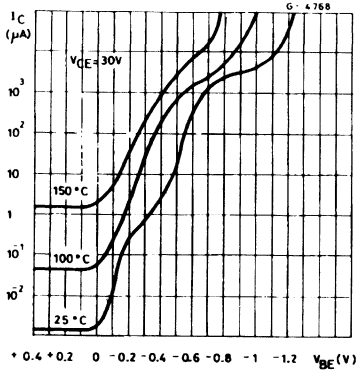

Capacitances (NPN types).

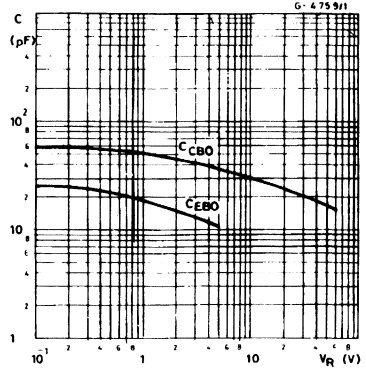

Capacitances (PNP types).

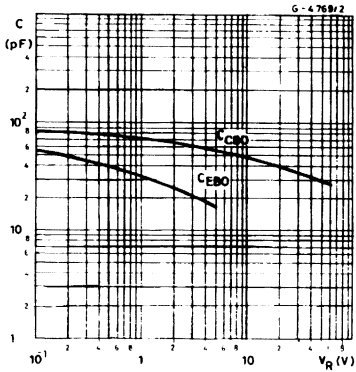

Saturated Switching Characteristics (NPN types).

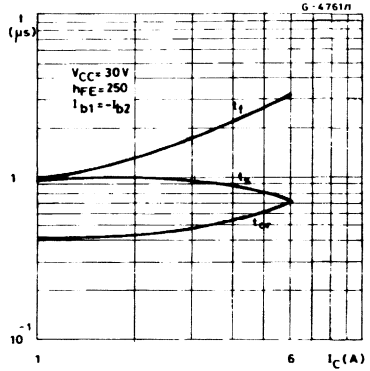

Saturated Switching Characteristics (PNP types).

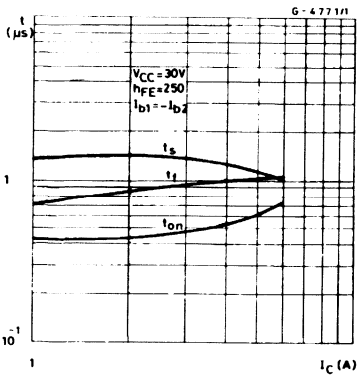

POWER DARLINGTONS
DESCRIPTION

The TIP120, TIP121 and TIP122 are silicon epitaxial-base NPN transistors in monolithic Darlington configuration in Jedec TO-220 plastic package, intended for use in power linear and switching applications. The complementary PNP types are the TIP125, TIP126 and TIP127 respectively.

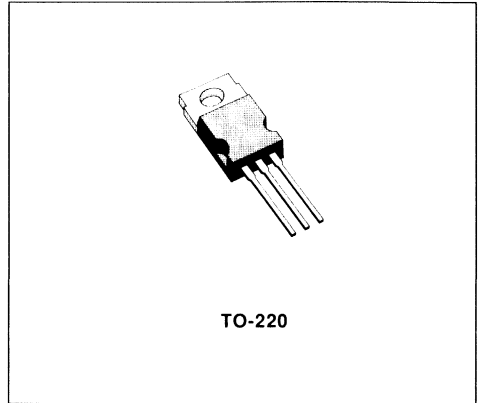
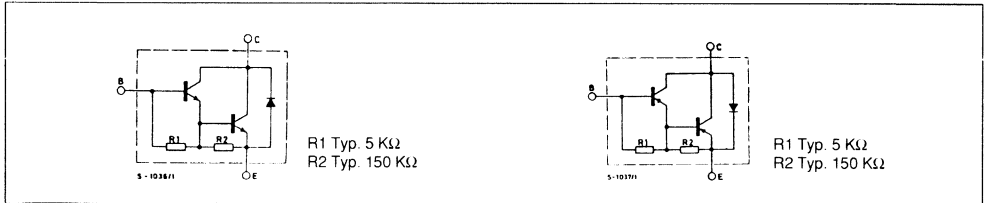
INTERNAL SCHEMATIC DIAGRAMS

ABSOLUTE MAXIMUM RATINGS

Symbol	Parameter	NPN PNP*	Value			Unit
			TIP120 TIP125	TIP121 TIP126	TIP122 TIP127	
V_{CBO}	Collector-base Voltage ($I_E = 0$)		60	80	100	V
V_{CEO}	Collector-emitter Voltage ($I_B = 0$)		60	80	100	V
V_{EBO}	Emitter-base Voltage ($I_C = 0$)		5			V
I_C	Collector Current		5			A
I_{CM}	Collector Peak Current		8			A
I_B	Base Current		0.1			A
P_{tot}	Total Power Dissipation at $T_{case} \leq 25^\circ\text{C}$ $T_{amb} \leq 25^\circ\text{C}$		65			W
			2			W
T_{stg}	Storage Temperature		- 65 to 150			$^\circ\text{C}$
T_j	Junction Temperature		150			$^\circ\text{C}$

* For PNP types voltage and current values are negative.

THERMAL DATA

$R_{th\ j-case}$	Thermal Resistance Junction-case	Max	1.92	°C/W
$R_{th\ j-amb}$	Thermal Resistance Junction-ambient	Max	62.5	°C/W

ELECTRICAL CHARACTERISTICS ($T_{case} = 25\text{ °C}$ unless otherwise specified)

Symbol	Parameter	Test Conditions	Min.	Typ.	Max.	Unit
I_{CEO}	Collector Cutoff Current ($I_B = 0$)	for TIP120/5 $V_{CE} = 30\text{ V}$ for TIP121/6 $V_{CE} = 40\text{ V}$ for TIP122/7 $V_{CE} = 50\text{ V}$			0.5 0.5 0.5	mA mA mA
I_{CBO}	Collector Cutoff Current ($I_E = 0$)	for TIP120/5 $V_{CB} = 60\text{ V}$ for TIP121/6 $V_{CB} = 80\text{ V}$ for TIP122/7 $V_{CB} = 100\text{ V}$			0.2 0.2 0.2	mA mA mA
I_{EBO}	Emitter Cutoff Current ($I_C = 0$)	$V_{EB} = 5\text{ V}$			2	mA
$V_{CEO(sus)}^*$	Collector-emitter Sustaining Voltage ($I_B = 0$)	$I_C = 30\text{ mA}$ for TIP120/5 for TIP121/6 for TIP122/7	60 80 100			V V V
$V_{CE(sat)}^*$	Collector-emitter Saturation Voltage	$I_C = 3\text{ A}$ $I_B = 12\text{ mA}$ $I_C = 5\text{ A}$ $I_B = 20\text{ mA}$			2 4	V V
$V_{BE(on)}^*$	Base-emitter Voltage	$I_C = 3\text{ A}$ $V_{CE} = 3\text{ V}$			2.5	V
h_{FE}^*	DC current Gain	$I_C = 0.5\text{ A}$ $V_{CE} = 3\text{ V}$ $I_C = 3\text{ A}$ $V_{CE} = 3\text{ V}$	1000 1000			

* Pulsed : pulse duration = 300 μ s, duty cycle \leq 2%.

Safe Operating Areas.

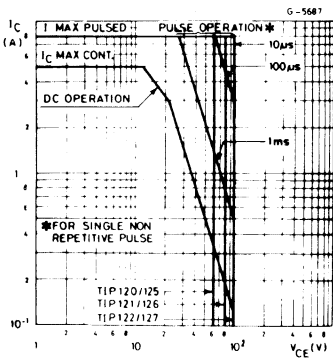

DC Current Gain (NPN types).

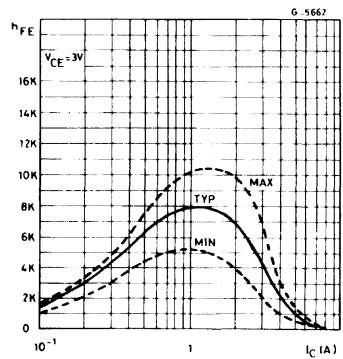

DC Current Gain (PNP types).

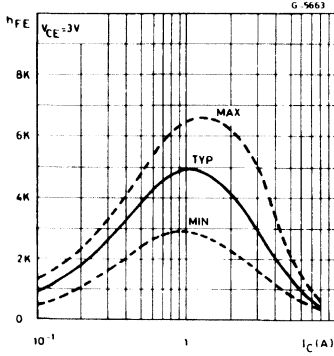

Collector-emitter Saturation Voltage (NPN types).

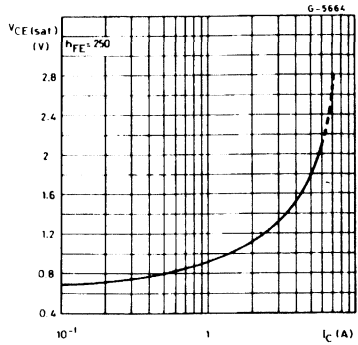

Collector-emitter Saturation Voltage (NPN types).

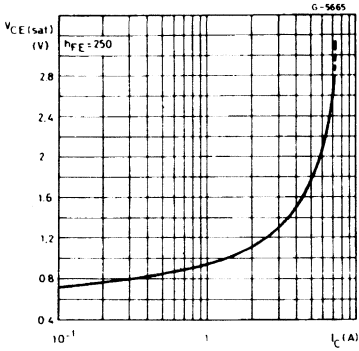

Base-emitter Saturation Voltage (NPN types).

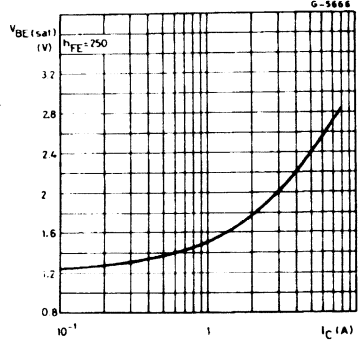

Base-emitter Saturation Voltage (PNP types).

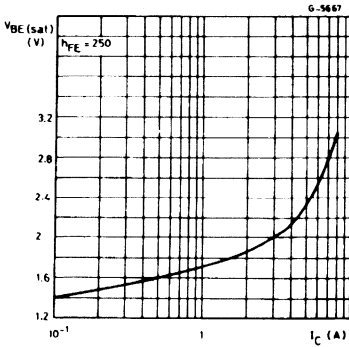

Base-emitter Voltage (NPN types).

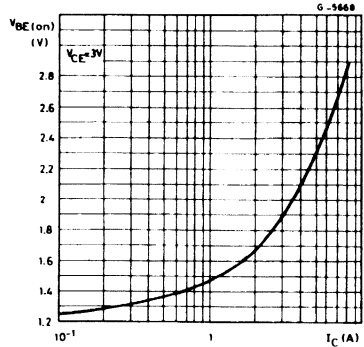

Base-emitter Voltage (PNP types).

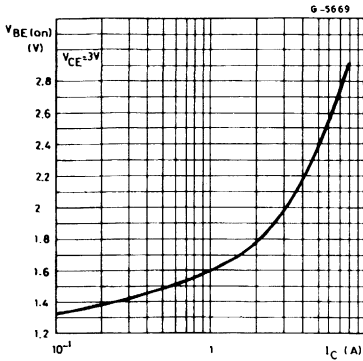

Freewheel Diode Forward Voltage (NPN types).

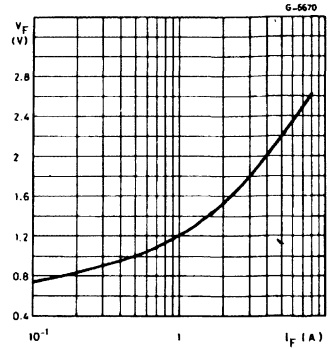

Freewheel Diode Forward Voltage (PNP types).

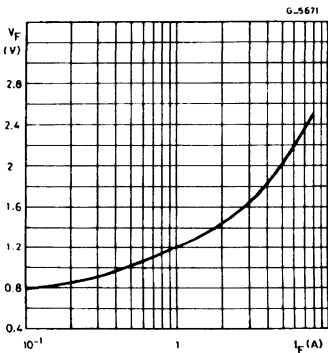

Switching Times vs. Tcase Resistive Load (NPN types).

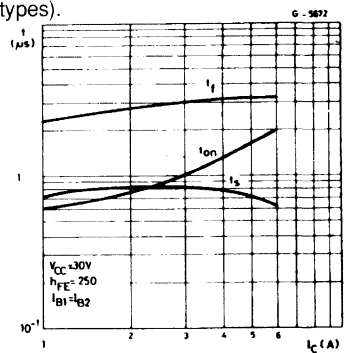

Switching Times vs. Tcase Resistive Load (PNP types).

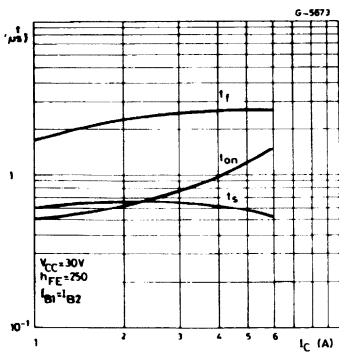

Derating Curve.

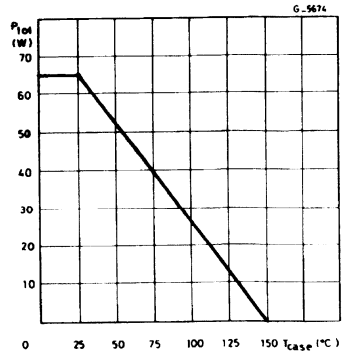

Free-air Temperature Derating Curve.

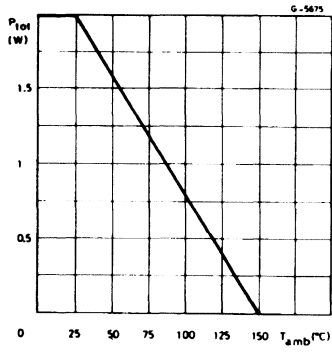

POWER DARLINGTONS

DESCRIPTION

The TIP130, TIP131, TIP132 and SGS130, SGS131, SGS132 are silicon epitaxial-base NPN transistors in monolithic Darlington configuration respectively in TO-220 and SOT-82 plastic package. They are intended for use in linear and switching applications. The complementary PNP types are the TIP135, TIP136 TIP137 and SGS135, SGS136, SGS137 respectively.

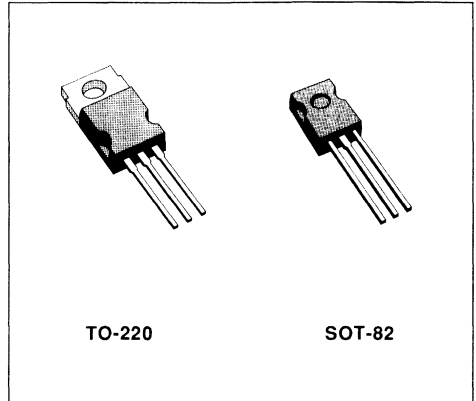

INTERNAL SCHEMATIC DIAGRAMS

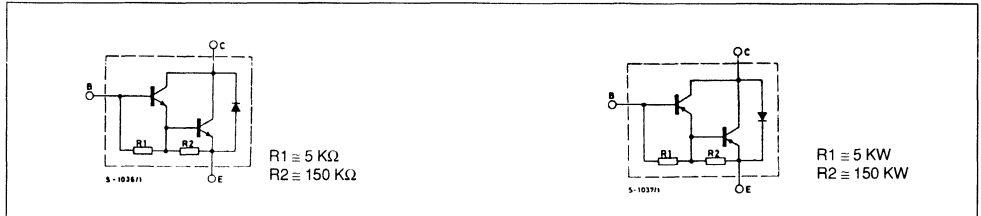

ABSOLUTE MAXIMUM RATINGS

Symbol	Parameter	NPN NPN PNP PNP	Value			Unit
			TIP130 SGS130	TIP131 SGS131	TIP132 SGS132	
V_{CBO}	Collector-base Voltage ($I_E = 0$)		60	80	100	V
V_{CEO}	Collector-emitter Voltage ($I_B = 0$)		60	80	100	V
V_{EBO}	Emitter-base Voltage ($I_C = 0$)			5		V
I_C	Collector Current			8		A
I_{CM}	Collector Peak Current			12		A
I_B	Base Current			0.3		A
P_{tot}	Total Power Dissipation at $T_{case} \leq 25^\circ\text{C}$ $T_{amb} \leq 25^\circ\text{C}$			70		W
T_{stg}	Storage Temperature			- 65 to 150		$^\circ\text{C}$
T_j	Junction Temperature			150		$^\circ\text{C}$

For PNP types voltage and current values are negative.

THERMAL DATA

$R_{th\ j-case}$	Thermal Resistance Junction-case	Max	1.78	$^{\circ}C/W$
$R_{th\ j-amb}$	Thermal Resistance Junction-ambient	Max	63.5	$^{\circ}C/W$

ELECTRICAL CHARACTERISTICS ($T_{case} = 25^{\circ}C$ unless otherwise specified)

Symbol	Parameter	Test Conditions	Min.	Typ.	Max.	Unit
I_{CEO}	Collector Cutoff Current ($I_B = 0$)	$V_{CE} = \text{Half Rated } V_{CEO}$			0.5	mA
I_{CBO}	Collector Cutoff Current ($I_E = 0$)	$V_{CB} = \text{Rated } V_{CBO}$			0.2	mA
I_{EBO}	Emitter Cutoff Current ($I_C = 0$)	$V_{EB} = 5\ V$			5	mA
$V_{CEO(sus)}^*$	Collector-emitter Sustaining Voltage ($I_B = 0$)	$I_C = 30\ \text{mA}$ for TIP/SGS130 and TIP/SGS135 for TIP/SGS131 and TIP/SGS136 for TIP/SGS132 and TIP/SGS137	60 80 100			V V V
$V_{CE(sat)}^*$	Collector-emitter Saturation Voltage	$I_C = 4\ \text{A}$ $I_B = 16\ \text{mA}$ $I_C = 6\ \text{A}$ $I_B = 30\ \text{mA}$			2 3	V V
V_{BE}^*	Base-emitter Voltage	$I_C = 4\ \text{A}$ $V_{CE} = 4\ \text{V}$			2.5	V
h_{FE}^*	DC current Gain	$I_C = 1\ \text{A}$ $V_{CE} = 4\ \text{V}$ $I_C = 4\ \text{A}$ $V_{CE} = 4\ \text{V}$	500 1000		15000	

* Pulsed : pulse duration = 300 μs , duty cycle $\leq 2\%$.
For PNP types voltage and current values are negative.

Safe Operating Areas.

Power Derating Chart.

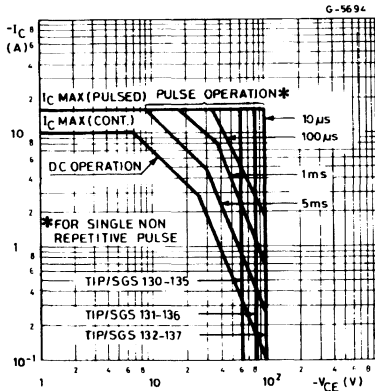

For the others characteristics see TIP100/105 series.

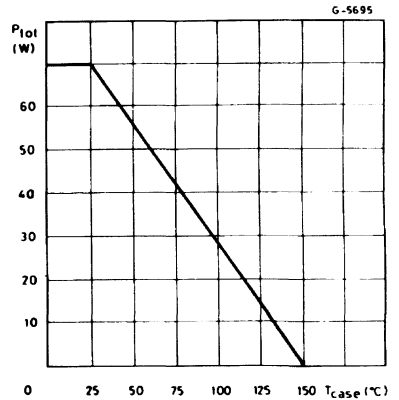

POWER DARLINGTONS
DESCRIPTION

The TIP140, TIP141, TIP142 are silicon epitaxial-base NPN transistors in monolithic Darlington configuration and are mounted in SOT-93 plastic package. They are intended for use in power linear and switching applications. The complementary PNP types are the TIP145, TIP146, TIP147 respectively.

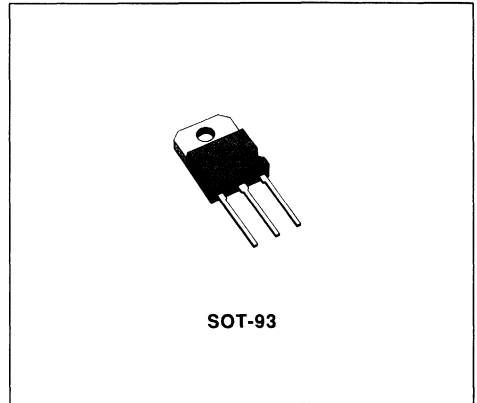
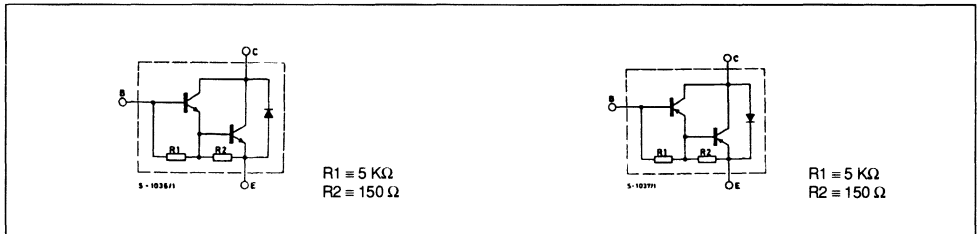
INTERNAL SCHEMATIC DIAGRAMS

ABSOLUTE MAXIMUM RATINGS

Symbol	Parameter	NPN *PNP	Value			Unit
			TIP140 TIP145	TIP141 TIP146	TIP142 TIP147	
V_{CBO}	Collector-base Voltage ($I_E = 0$)		60	80	100	V
V_{CEO}	Collector-emitter Voltage ($I_B = 0$)		60	80	100	V
V_{EBO}	Emitter-base Voltage ($I_C = 0$)		5			V
I_C	Collector Current		10			A
I_{CM}	Collector Peak Current (repetitive)		20			A
I_B	Base Current		0.5			A
P_{tot}	Total Power Dissipation at $T_{case} \leq 25^\circ\text{C}$		125			W
T_{stg}	Storage Temperature		- 65 to 150			$^\circ\text{C}$
T_j	Junction Temperature		150			$^\circ\text{C}$

* For PNP types voltage and current values are negative.

THERMAL DATA

$R_{th\ j-case}$	Thermal Resistance Junction-case	Max	1	°C/W
------------------	----------------------------------	-----	---	------

ELECTRICAL CHARACTERISTICS ($T_{case} = 25\text{ °C}$ unless otherwise specified)

Symbol	Parameter	Test Conditions	Min.	Typ.	Max.	Unit
I_{CBO}	Collector Cutoff Current ($I_E = 0$)	for TIP140/5 $V_{CB} = 60\text{ V}$ for TIP141/6 $V_{CB} = 80\text{ V}$ for TIP142/7 $V_{CB} = 100\text{ V}$			1 1 1	mA mA mA
I_{CEO}	Collector Cutoff Current ($I_B = 0$)	for TIP140/5 $V_{CB} = 30\text{ V}$ for TIP141/6 $V_{CE} = 40\text{ V}$ for TIP142/7 $V_{CE} = 50\text{ V}$			2 2 2	mA mA mA
I_{EBO}	Emitter Cutoff Current ($I_C = 0$)	$V_{EBO} = 5\text{ V}$			2	mA
$V_{CEO(sus)}^*$	Collector-emitter Sustaining Voltage ($I_B = 0$)	$I_C = 30\text{ mA}$ for TIP140/5 for TIP141/6 for TIP142/7	60 80 100			V V V
$V_{CE(sat)}^*$	Collector-emitter Saturation Voltage	$I_C = 5\text{ A}$ $I_B = 10\text{ mA}$ $I_C = 10\text{ A}$ $I_B = 40\text{ mA}$			2 3	V V
V_{BE}^*	Base-emitter Voltage	$I_C = 10\text{ A}$ $V_{CE} = 4\text{ V}$			3	V
h_{FE}^*	DC current Gain	$I_C = 5\text{ A}$ $V_{CE} = 4\text{ V}$ $I_C = 10\text{ A}$ $V_{CE} = 4\text{ V}$	1000 500			
t_{on}	Turn-on Time	$I_C = 10\text{ A}$ $I_{B1} = 40\text{ mA}$		0.9		μs
t_{off}	Turn-off Time	$I_{B2} = -40\text{ mA}$ $R_L = 3\text{ }\Omega$		4		μs

* Pulsed : pulse duration = 200 μs, duty cycle = 1.5 %.
For PNP devices voltage and current values are negative.

Safe Operating Areas.

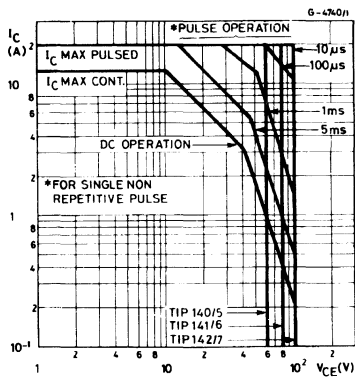

DC Current Gain (TIP140/1/2).

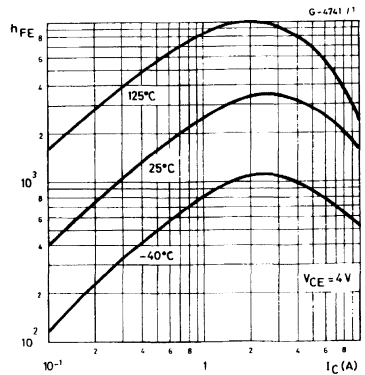

DC Transconductance (TIP140/1/2).

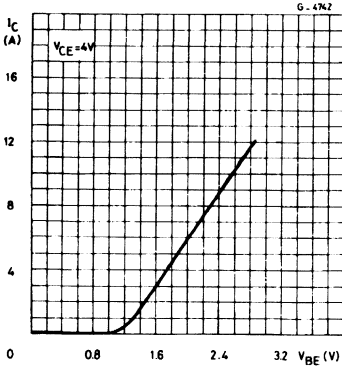

Collector-emitter Saturation Voltage (TIP140/1/2).

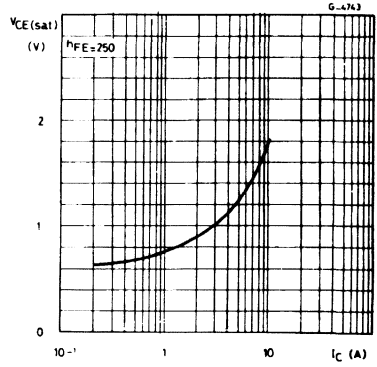

Collector-emitter Saturation Voltage (TIP140/1/2).

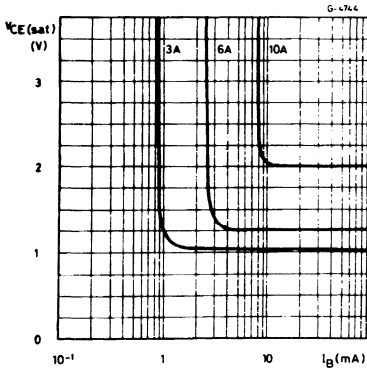

DC Current Gain (TIP145/6/7)

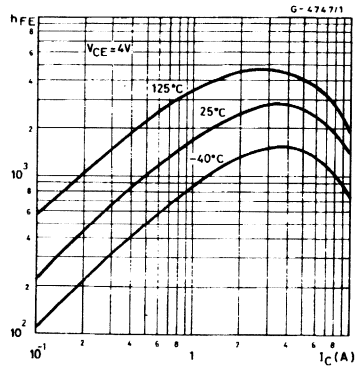

DC Transconductance (TIP145/6/7).

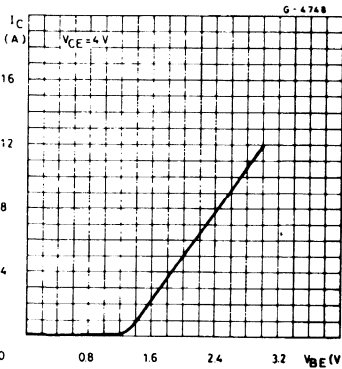

Collector-emitter Saturation Voltage (TIP145/6/7).

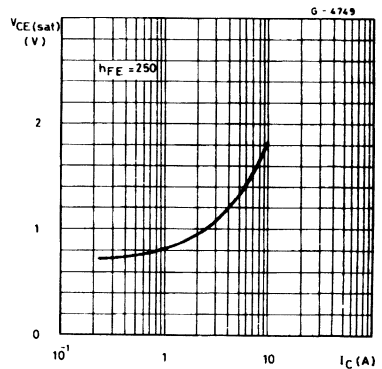

Collector-emitter Saturation Voltage (TIP145/6/7).

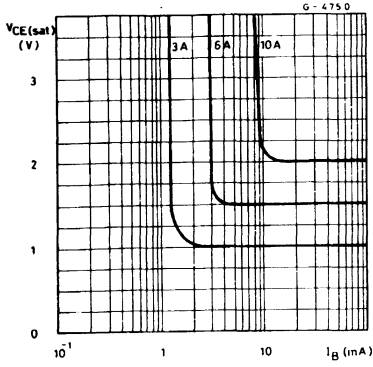

LOW VOLTAGE HIGH CURRENT POWER DARLINGTON

ADVANCE DATA

- MONOLITHIC DARLINGTON CONFIGURATION
- LOW VOLTAGE
- HIGH CURRENT
- HIGH GAIN

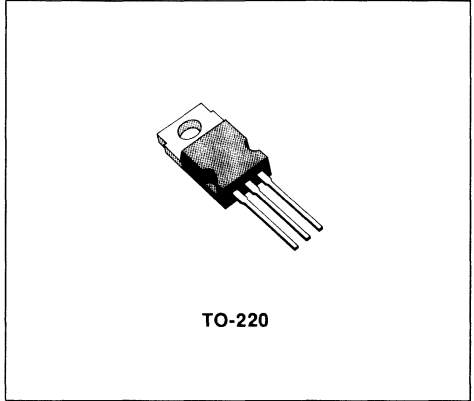

DESCRIPTION

The TIP140T, TIP141T and TIP142T are silicon multi-epitaxial base NPN transistor in monolithic Darlington configuration mounted in TO-220 package.

They are intended for use in power linear and switching applications. The complementary PNP types are the TIP145T, TIP146T and TIP147T respectively.

INTERNAL SCHEMATIC DIAGRAM

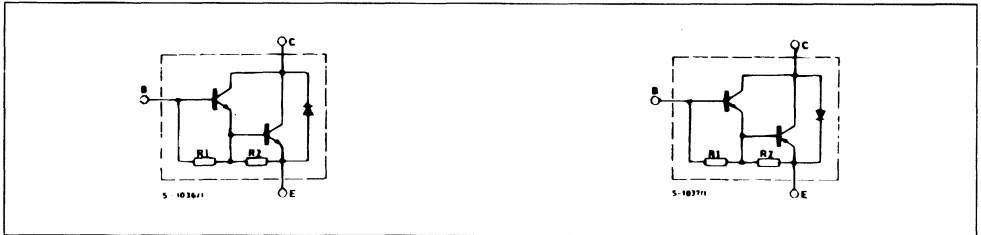

ABSOLUTE MAXIMUM RATINGS

Symbol	Parameter	NPN PNP	Value			Unit
			TIP140T TIP145T	TIP141T TIP146T	TIP142T TIP147T	
V_{CBO}	Collector-base Voltage ($I_E = 0$)		60	80	100	V
V_{CEO}	Collector-emitter Voltage ($I_B = 0$)		60	80	100	V
V_{EBO}	Emitter-base Voltage ($I_C = 0$)		5			V
I_C	Collector Current		15			A
I_{CM}	Collector Peak Current ($t_p < 5ms$)		20			A
I_B	Base Current		0.5			A
P_{tot}	Total Dissipation at $T_C < 25^\circ C$		125			W
T_{stg}	Storage Temperature		- 65 to 150			$^\circ C$
T_j	Max. Operating Junction Temperature		150			$^\circ C$

For PNP types voltage and current values are negative.

THERMAL DATA

$R_{thj-case}$	Thermal Resistance Junction-case	max	1	$^{\circ}C/W$
----------------	----------------------------------	-----	---	---------------

ELECTRICAL CHARACTERISTICS ($T_{case} = 25^{\circ}C$ unless otherwise specified)

Symbol	Parameter	Test Conditions		Min.	Typ.	Max.	Unit
I_{CBO}	Collector Cutoff Current ($I_E = 0$)	$V_{CB} = 60V$ $V_{CB} = 80V$ $V_{CB} = 100V$	for TIP140T/145T for TIP141T/146T for TIP142T/147T			1 1 1	mA mA mA
I_{CEO}	Collector Cutoff Current ($I_B = 0$)	$V_{CE} = 30V$ $V_{CE} = 40V$ $V_{CE} = 50V$	for TIP140T/145T for TIP141T/146T for TIP142T/147T			2 2 2	mA mA mA
I_{EB0}	Emitter Cutoff Current ($I_C = 0$)	$V_{EB} = 5V$				2	mA
$V_{CE0(sus)}^*$	Collector-emitter Sustaining Voltage	$I_C = 30mA$	for TIP140T/145T for TIP141T/146T for TIP142T/147T	60 80 100			V V V
$V_{CE(sat)}^*$	Collector-emitter Saturation Voltage	$I_C = 5A$ $I_C = 10A$	$I_B = 10mA$ $I_B = 40mA$			2 3	V V
$V_{BE(0n)}^*$	Base-emitter Voltage	$I_C = 10A$	$V_{CE} = 4V$			3	V
h_{FE}^*	DC Current Gain	$I_C = 5A$ $I_C = 10A$	$V_{CE} = 4V$ $V_{CE} = 4V$	1000 500			
t_{on} t_{off}	RESISTIVE LOAD Turn-on Time Turn-off Time	$I_C = 10A$ $I_{B2} = -40mA$	$I_{B1} = 10mA$ $R_L = 3\Omega$		0.9 4		μs μs

* Pulsed : pulse duration = 300 μs , duty cycle = 1.5%.
For PNP types voltage and current value are negative.

COMPLEMENTARY TRANSISTORS

PRELIMINARY DATA

DESCRIPTION

The TIP3055 is a silicon epitaxial base NPN transistor mounted in TO-218 plastic package and intended for power switching circuits, serie and shunt regulators, output stages and high fidelity amplifiers.

The complementary PNP type is the TIP2955.

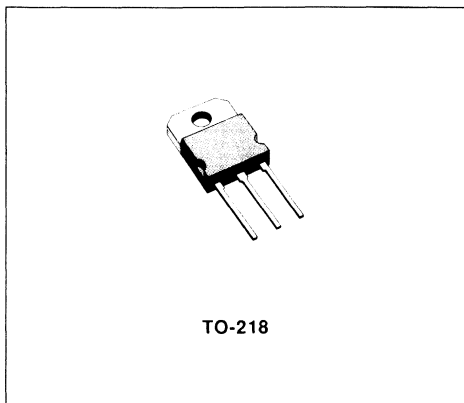

INTERNAL SCHEMATIC DIAGRAM

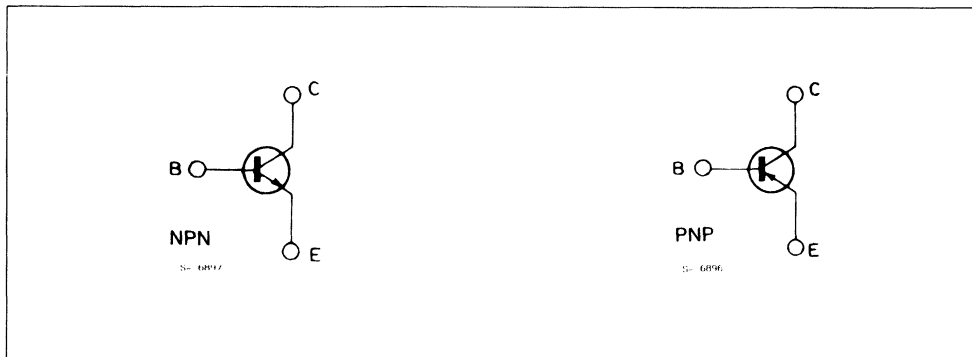

ABSOLUTE MAXIMUM RATINGS

Symbol	Parameter	Value	Unit
V_{CBO}	Collector-base Voltage ($I_E = 0$)	100	V
V_{CEO}	Collector-emitter Voltage ($I_B = 0$)	60	V
I_C	Collector Current	15	A
I_B	Base Current	7	A
P_{tot}	Total Dissipation at $T_c < 25^\circ\text{C}$	90	W
T_{stg}	Storage Temperature	- 65 to 150	$^\circ\text{C}$
T_j	Max. Operating Junction Temperature	150	$^\circ\text{C}$

For PNP type voltage and current values are negative.

THERMAL DATA

R _{thj-case}	Thermal Resistance Junction-case	max	1.4	°C/W
-----------------------	----------------------------------	-----	-----	------

ELECTRICAL CHARACTERISTICS (T_{case} = 25°C unless otherwise specified)

Symbol	Parameter	Test Conditions	Min.	Typ.	Max.	Unit
I _{CEX}	Collector Cutoff Current	V _{CE} = 100V V _{BE} = -1.5V			5	mA
I _{CEO}	Collector Cutoff Current (I _B = 0)	V _{CE} = 30V			0.7	mA
I _{EBO}	Emitter Cutoff Current (I _C = 0)	V _{EB} = 7V			5	mA
V _{CE0(sus)} *	Collector-emitter Sustaining Voltage	I _C = 30mA	60			V
V _{CE(sat)} *	Collector-emitter Saturation Voltage	I _C = 4A I _B = 0.4A I _C = 10A I _B = 3.3A			1.1 3	V V
V _{BE(on)} *	Base-emitter Voltage	I _C = 4A V _{CE} = 4V			1.8	V
h _{FE} *	DC Current Gain	I _C = 4A V _{CE} = 4V I _C = 10A V _{CE} = 4V	20 5			
h _{fe}	Small Signal Current Gain	I _C = 1A V _{CE} = 10V f = 1KHz	15			
f _T	Transition Frequency	I _C = 0.5A V _{CE} = 10V f = 1MHz	3			MHz
t _{on} t _{off}	RESISTIVE LOAD Turn-on Time Turn-off Time	I _C = 6A I _{B1} = 0.6A I _{B2} = -0.6A V _{BEoff} = -4V R _L = 5Ω		0.5 0.9		μs μs

* Pulsed : pulse duration = 300μs, duty cycle = 1.5%.
For PNP type voltage and current value are negative.

POWER LINEAR AND SWITCHING APPLICATIONS
DESCRIPTION

The 2N3055 is a silicon epitaxial-base NPN transistor in Jedec TO-3 metal case. It is intended for power switching circuits, series and shunt regulators, output stages and high fidelity amplifiers.

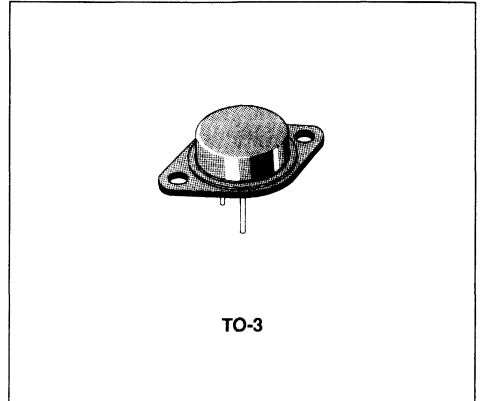
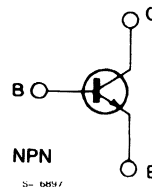
INTERNAL SCHEMATIC DIAGRAM

ABSOLUTE MAXIMUM RATINGS

Symbol	Parameter	Value	Unit
V_{CBO}	Collector-base Voltage ($I_E = 0$)	100	V
V_{CER}	Collector-emitter Voltage ($R_{BE} = 100 \Omega$)	70	V
V_{CEO}	Collector-emitter Voltage ($I_B = 0$)	60	V
V_{EBO}	Emitter-base Voltage ($I_C = 0$)	7	V
I_C	Collector Current	15	A
I_B	Base Current	7	A
P_{tot}	Total Power Dissipation at $T_{case} \leq 25^\circ C$	115	W
T_{stg}	Storage Temperature	- 65 to 200	$^\circ C$
T_j	Junction Temperature	200	$^\circ C$

THERMAL DATA

$R_{th\ j-case}$	Thermal Resistance Junction-case	Max	1.5	$^{\circ}C/W$
------------------	----------------------------------	-----	-----	---------------

ELECTRICAL CHARACTERISTICS ($T_{case} = 25^{\circ}C$ unless otherwise specified)

Symbol	Parameter	Test Conditions	Min.	Typ.	Max.	Unit
I_{CEV}	Collector Cutoff Current ($V_{BE} = -1.5V$)	$V_{CE} = 100V$ $V_{CE} = 100V$ $T_{case} = 150^{\circ}C$			1 5	mA mA
I_{CEO}	Collector Cutoff Current ($I_B = 0$)	$V_{CE} = 30V$			0.7	mA
I_{EBO}	Emitter Cutoff Current ($I_C = 0$)	$V_{EB} = 7V$			5	mA
$V_{CER(sus)}^*$	Collector-emitter Sustaining Voltage ($R_{BE} = 100\Omega$)	$I_C = 200mA$	70			V
$V_{CEO(sus)}^*$	Collector-emitter Sustaining Voltage ($I_B = 0$)	$I_C = 200mA$	60			V
$V_{CE(sat)}^*$	Collector-emitter Saturation Voltage	$I_C = 4A$ $I_B = 400mA$ $I_C = 10A$ $I_B = 3.3A$			1 3	V V
V_{BE}^*	Base-emitter Voltage	$I_C = 4A$ $V_{CE} = 4V$			1.5	V
h_{FE}^*	DC Current Gain					
	Group 4	$I_C = 0.5A$ $V_{CE} = 4V$	20		50	
	Group 5	$I_C = 0.5A$ $V_{CE} = 4V$	35		75	
	Group 6	$I_C = 0.5A$ $V_{CE} = 4V$	60		145	
	Group 7	$I_C = 0.5A$ $V_{CE} = 4V$	120		250	
		$I_C = 4A$ $V_{CE} = 4V$	20		70	
		$I_C = 10A$ $V_{CE} = 4V$	5			
h_{FE1}/h_{FE2}^*	Matched Pair	$I_C = 0.5A$ $V_{CE} = 4V$			1.6	
f_T	Transition Frequency	$I_C = 1A$ $V_{CE} = 4V$	2.5			MHz
$I_{s/b}^*$	Second Breakdown Collector Current	$V_{CE} = 40V$	2.87			A

* Pulsed : pulse duration = 300 μ s, duty cycle = 1.5%.

** Pulsed : 1s, non repetitive pulse.

Safe Operating Areas.

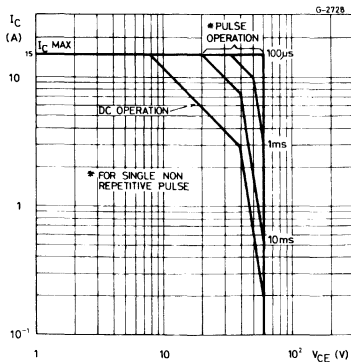

DC Current Gain.

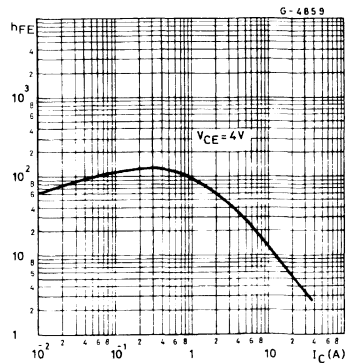

Collector-emitter Saturation Voltage.

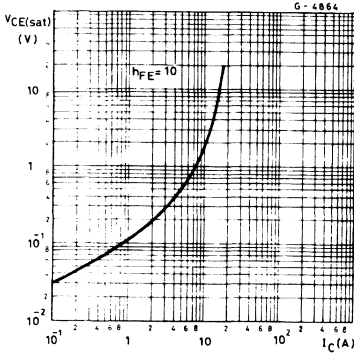

Base-emitter Saturation Voltage.

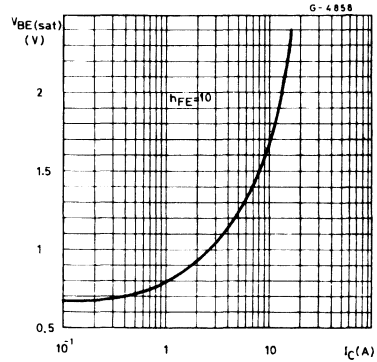

Small Signal Current Gain.

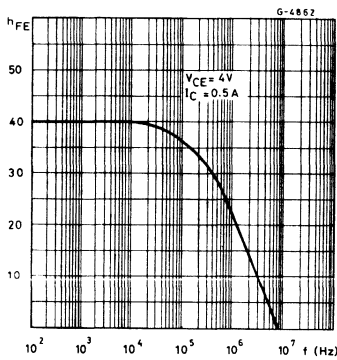

Collector-base Capacitance.

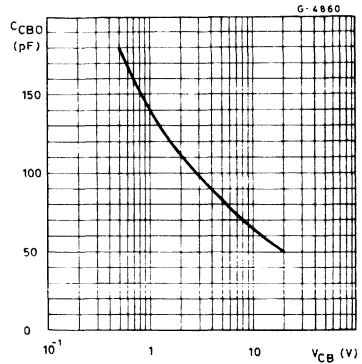

Saturated Switching Characteristics.

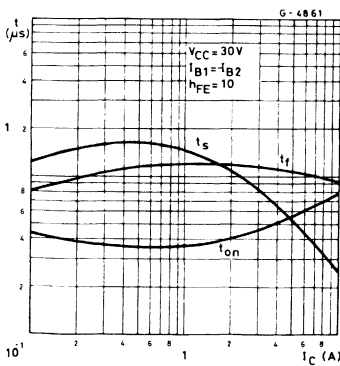

Power Rating Chart.

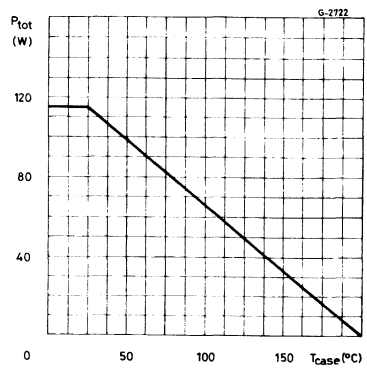

HIGH VOLTAGE TRANSISTORS

DESCRIPTION

The 2N3439, 2N3440 are high voltage silicon epitaxial planar transistors designed for use in consumer and industrial line-operated applications. These devices are particularly suited as drivers in high-voltage low current inverters, switching and series regulators.

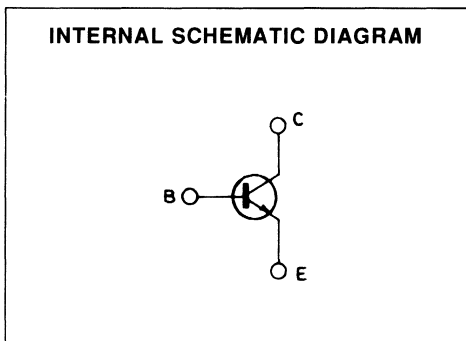
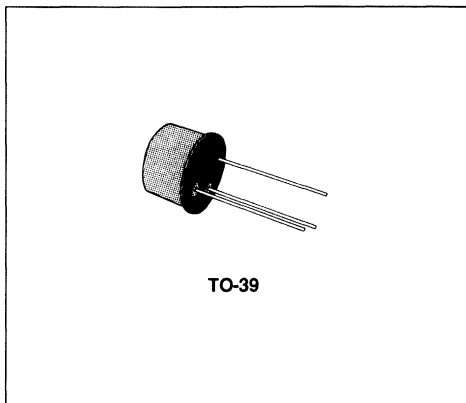

ABSOLUTE MAXIMUM RATINGS

Symbol	Parameter	2N3439	2N3440	Unit
V_{CBO}	Collector-base Voltage ($I_E = 0$)	450	300	V
V_{CEO}	Collector-emitter Voltage ($I_B = 0$)	350	250	V
V_{EBO}	Emitter-base Voltage ($I_C = 0$)	7		V
I_C	Collector Current	1		A
I_B	Base Current	0.5		A
P_{tot}	Total Power Dissipation at $T_{case} \leq 25^\circ\text{C}$ $T_{amb} \leq 50^\circ\text{C}$	10		W
		1		W
T_{stg}	Storage Temperature	- 65 to 200		$^\circ\text{C}$
T_j	Junction Temperature	200		$^\circ\text{C}$

THERMAL DATA

$R_{th\ j-case}$	Thermal Resistance Junction-case	Max	17.5	$^{\circ}C/W$
$R_{th\ j-amb}$	Thermal Resistance Junction-ambient	Max	150	$^{\circ}C/W$

ELECTRICAL CHARACTERISTICS($T_{case} = 25^{\circ}C$ unless otherwise specified)

Symbol	Parameter	Test Conditions	Min.	Typ.	Max.	Unit
I_{CBO}	Collector Cutoff Current ($I_E = 0$)	for 2N3439 $V_{CB} = 360V$ for 2N3440 $V_{CB} = 250V$			20 20	μA μA
I_{CEO}	Collector Cutoff Current ($I_B = 0$)	for 2N3439 $V_{CE} = 300V$ for 2N3440 $V_{CE} = 200V$			20 50	μA μA
I_{CEX}	Collector Cutoff Current ($V_{BE} = -1.5V$)	for 2N3439 $V_{CE} = 450V$ for 2N3440 $V_{CE} = 300V$			500 500	μA μA
I_{EBO}	Emitter Cutoff Current ($I_C = 0$)	$V_{EB} = 6V$			20	μA
$V_{CEO(sus)^*}$	Collector-emitter Sustaining Voltage ($I_B = 0$)	$I_C = 50mA$ for 2N3439 for 2N3440	350 250			V V
$V_{CE(sat)^*}$	Collector-emitter Saturation Voltage	$I_C = 50mA$ $I_B = 4mA$			0.5	V
$V_{BE(sat)^*}$	Base-emitter Saturation Voltage	$I_C = 50mA$ $I_B = 4mA$			1.3	V
C_{ob}	Output Capacitance	$V_{CB} = 10V$, $f = 1MHz$			10	pF
h_{FE}^*	DC Current Gain	$I_C = 20mA$ $V_{CE} = 10V$ for 2N3439 $I_C = 2mA$ $V_{CE} = 10V$	40 30		160	
h_{FE}	Small Signal Current Gain	$I_C = 5mA$ $f = 1KHz$ $V_{CE} = 10V$	25			
f_T	Transition Frequency	$I_C = 10mA$ $f = 5MHz$ $V_{CE} = 10V$	15			MHz

* Pulsed : pulse duration = 300 μs , duty cycle $\leq 2\%$.

Safe Operating Areas.

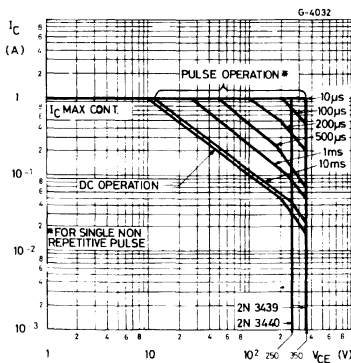

DC Current Gain.

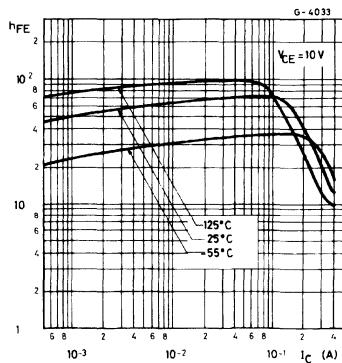

Collector-emitter Saturation Voltage.

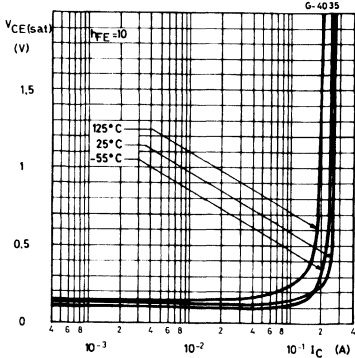

Base-emitter Voltage.

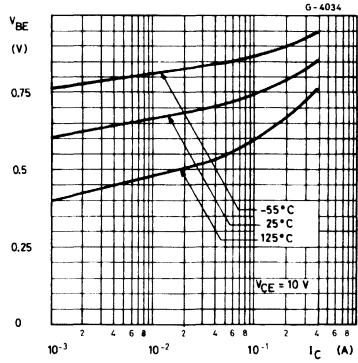

Transition Frequency.

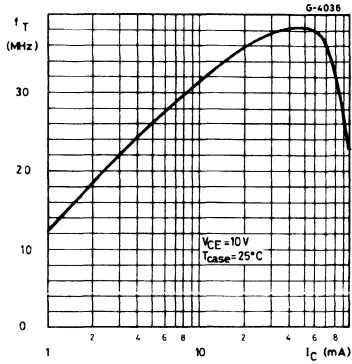

Power Rating Chart.

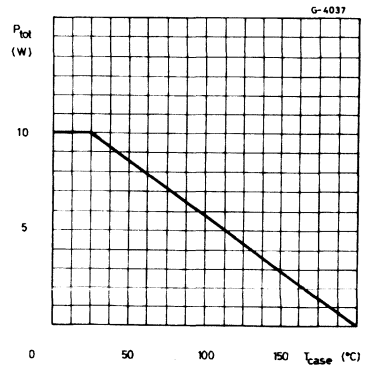

EPITAXIAL-BASE NPN/PNP
DESCRIPTION

The 2N3713, 2N3714, 2N3715 and 2N3716 are silicon epitaxial-base NPN power transistors in Jedec TO-3 metal case. They are intended for use in power linear and switching applications.

The complementary PNP types are the 2N3789, 2N3790, 2N3791 and 2N3792 respectively.

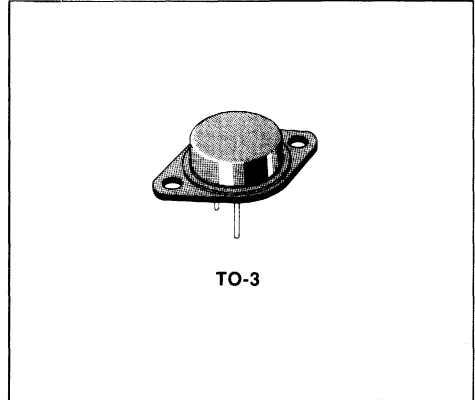
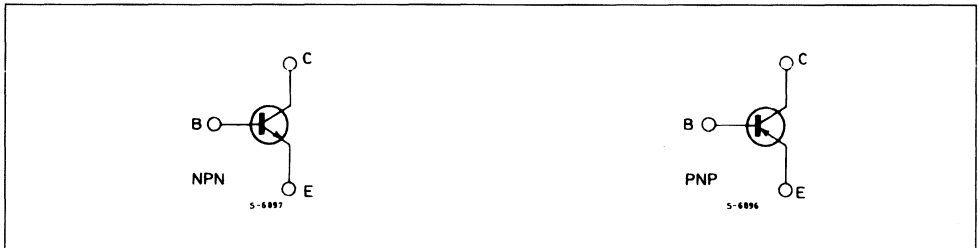
INTERNAL SCHEMATIC DIAGRAMS

ABSOLUTE MAXIMUM RATINGS

Symbol	Parameter	PNP*	2N3789	2N3790	Unit
		PNP*	2N3791	2N3792	
		NPN	2N3713	2N3714	
		NPN	2N3715	2N3716	
V_{CBO}	Collector-base Voltage ($I_E = 0$)		80	100	V
V_{CEO}	Collector-emitter Voltage ($I_B = 0$)		60	80	V
V_{EBO}	Emitter-base Voltage ($I_C = 0$)		7		V
I_C	Collector Current		10		A
I_B	Base Current		4		A
P_{tot}	Total Power Dissipation at $T_{case} \leq 25^\circ C$		150		W
T_{stg}	Storage Temperature		- 65 to 200		$^\circ C$
T_j	Junction Temperature		200		$^\circ C$

* For PNP types voltage and current values are negative.

THERMAL DATA

$R_{th\ j-case}$	Thermal Resistance Junction-case	Max	1.17	°C/W
------------------	----------------------------------	-----	------	------

ELECTRICAL CHARACTERISTICS ($T_{case} = 25\text{ °C}$ unless otherwise specified)

Symbol	Parameter	Test Conditions	Min.	Typ.	Max.	Unit
I_{CEX}	Collector Cutoff Current ($V_{BE} = -1.5\text{ V}$)	$V_{CE} = 80\text{ V}$ for 2N3713/15/89/91			1	mA
		$V_{CE} = 100\text{ V}$ for 2N3714/16/90/92			1	mA
		$T_{case} = 150\text{ °C}$ $V_{CE} = 60\text{ V}$ for 2N3713/15/89/91			10	mA
		$V_{CE} = 80\text{ V}$ for 2N3713/14/90/92			10	mA
I_{EBO}	Emitter Cutoff Current ($I_C = 0$)	$V_{EB} = 7\text{ V}$			5	mA
$V_{CEO(sus)}^*$	Collector-emitter Sustaining Voltage ($I_B = 0$)	$I_C = 200\text{ mA}$ for 2N3713/15/89/91 for 2N3714/16/90/92	60 80			V V
$V_{CE(sat)}^*$	Collector-emitter Saturation Voltage	$I_C = 5\text{ A}$ $I_B = 0.5\text{ A}$ for 2N3713/14/91/92			1	V
		for 2N3715/16			0.8	V
		$I_C = 4\text{ A}$ $I_B = 0.5\text{ A}$ for 2N3789/90			1	V
$V_{BE(sat)}^*$	Base-emitter Saturation Voltage	$I_C = 5\text{ A}$ $I_B = 0.5\text{ A}$ for 2N3713/14/89/90 for 2N3715/16/91/92			2 1.5	V V
V_{BE}^*	Base-emitter Voltage	$I_C = 3\text{ A}$ $V_{CE} = 2\text{ V}$			1.5	V
h_{FE}^*	DC Current Gain	$I_C = 1\text{ A}$ $V_{CE} = 2\text{ V}$ for 2N3713/14/89/90	25		90	
		for 2N3715/16	50		150	
		for 2N3791/92	50		180	
		$I_C = 3\text{ A}$ $V_{CE} = 2\text{ V}$ for 2N3713/14/89/90	15			
	for 2N3715/16/91/92	30				
	$I_C = 10\text{ A}$ $V_{CE} = 4\text{ V}$	5				
f_T	Transition Frequency	$I_C = 0.5\text{ A}$ $V_{CE} = 10\text{ V}$	4			MHz

* Pulsed : pulse duration = 300µs, duty cycle = 1.5%.

Safe Operating Areas.

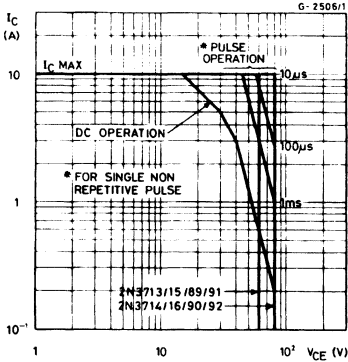

DC Current Gain (NPN types).

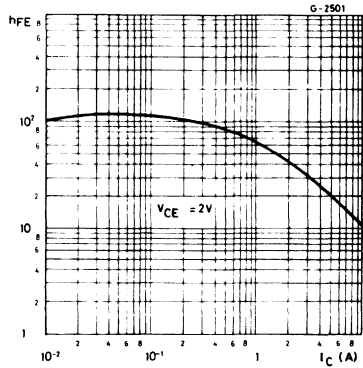

DC Current Gain (PNP types).

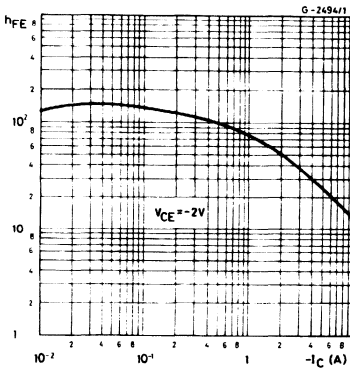

DC Transconductance (NPN types).

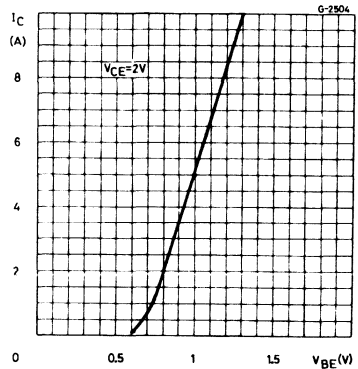

DC Transconductance (PNP types).

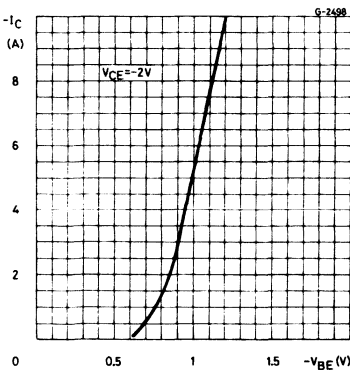

Collector-emitter Saturation Voltage (NPN types).

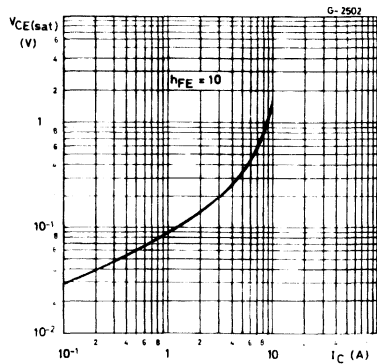

Collector-emitter Saturation Voltage (PNP types).

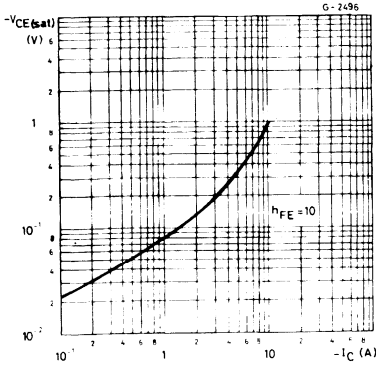

Base-emitter Saturation Voltage (NPN types).

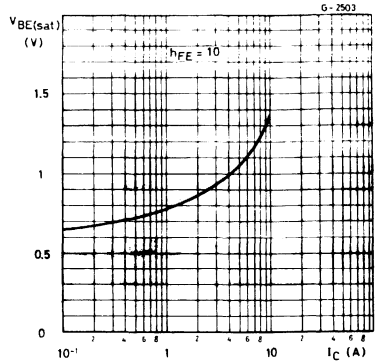

Base-emitter Saturation Voltage (PNP types).

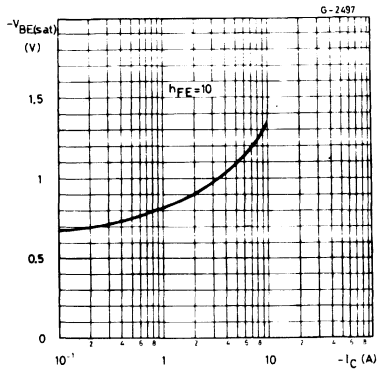

Collector-base Capacitance (NPN types).

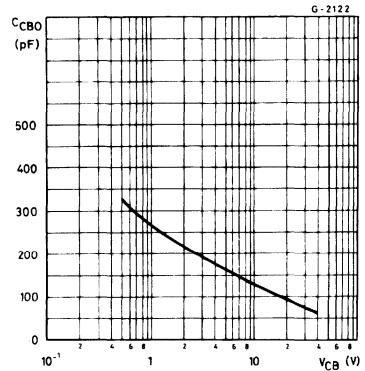

Collector-base Capacitance (PNP types).

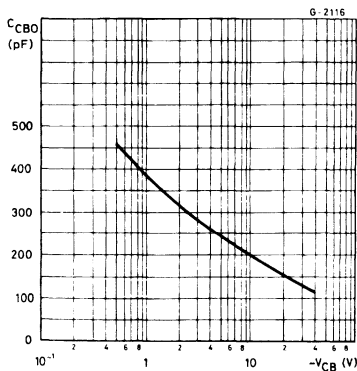

Transition Frequency (NPN types).

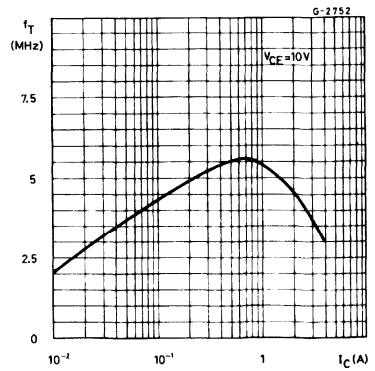

Transition Frequency (PNP types).

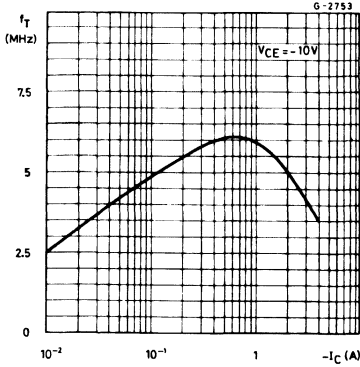

Saturated Switching Characteristics (NPN types).

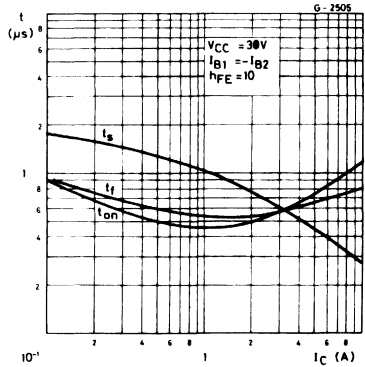

Saturated Switching Characteristics (PNP types).

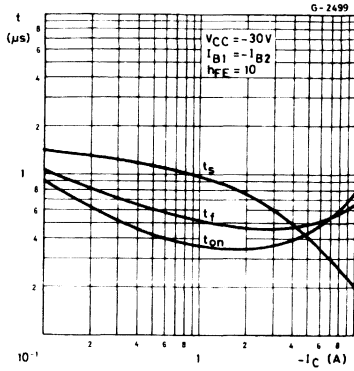

HIGH POWER TRANSISTORS

DESCRIPTION

The 2N3771, 2N3772 are silicon epitaxial-base NPN transistors mounted in Jedec TO-3 metal case. They are intended for linear amplifiers and inductive switching applications.

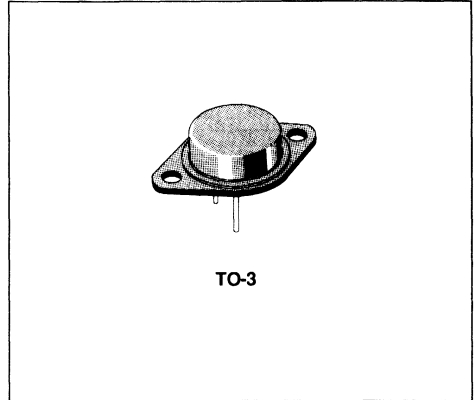

INTERNAL SCHEMATIC DIAGRAM

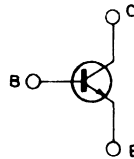

ABSOLUTE MAXIMUM RATINGS

Symbol	Parameter	2N3771	2N3772	Unit
V_{CE0}	Collector-emitter Voltage ($I_B = 0$)	40	60	V
V_{CEV}	Collector-emitter Voltage ($V_{BE} = -1.5V$)	50	80	V
V_{CB0}	Collector-base Voltage ($I_E = 0$)	50	100	V
V_{EB0}	Emitter-base Voltage ($I_C = 0$)	5	7	V
I_C	Collector Current	15	10	A
I_{CM}	Collector Peak Current	30	30	A
I_B	Base Current	7.5	5	A
I_{BM}	Base Peak Current	15	15	A
P_{tot}	Total Power Dissipation at $T_{case} \leq 25^\circ C$	150		W
T_{stg}	Storage Temperature	- 65 to 200		$^\circ C$
T_j	Junction Temperature	200		$^\circ C$

THERMAL DATA

$R_{th\ j-case}$	Thermal Resistance Junction-case	Max	1.17	°C/W
------------------	----------------------------------	-----	------	------

ELECTRICAL CHARACTERISTICS ($T_{case} = 25^{\circ}C$ unless otherwise specified)

Symbol	Parameter	Test Conditions	Min.	Typ.	Max.	Unit
I_{CEO}	Collector Cutoff Current ($I_B = 0$)	for 2N3771 $V_{CE} = 30V$ for 2N3772 $V_{CE} = 50V$			10 10	mA mA
I_{CEV}	Collector Cutoff Current ($V_{BE} = -1.5V$)	for 2N3771 $V_{CE} = 50V$ for 2N3772 $V_{CE} = 100V$ for all $V_{CE} = 30V$ $T_{case} = 150^{\circ}C$			2 5 10	mA mA mA
I_{CBO}	Collector Cutoff Current ($I_E = 0$)	for 2N3771 $V_{CB} = 50V$ for 2N3772 $V_{CB} = 100V$			4 5	mA mA
I_{EBO}	Emitter Cutoff Current ($I_C = 0$)	for 2N3771 $V_{EB} = 5V$ for 2N3772 $V_{EB} = 7V$			5 5	mA mA
$V_{CEO(sus)}^*$	Collector-emitter Sustaining Voltage ($I_B = 0$)	$I_C = 0.2A$ for 2N3771 for 2N3772	40 60			V V
$V_{CEV(sus)}^*$	Collector-emitter Sustaining Voltage ($V_{EB} = -1.5V$)	$I_C = 0.2A$ $R_{BE} = 100\Omega$ for 2N3771 for 2N3772	50 80			V V
$V_{CER(sus)}^*$	Collector-emitter Sustaining Voltage ($R_{BE} = 100\Omega$)	$I_C = 0.2A$ for 2N3771 for 2N3772	45 70			V V
h_{FE}^*	DC Current Gain	for 2N3771 $I_C = 15A$ $V_{CE} = 4V$ $I_C = 30A$ $V_{CE} = 4V$ for 2N3772 $I_C = 10A$ $V_{CE} = 4V$ $I_C = 20A$ $V_{CE} = 4V$	15 5 15 5		60 60	
V_{BE}^*	Base-emitter Voltage	for 2N3771 $I_C = 15A$ $V_{CE} = 4V$ for 2N3772 $I_C = 10A$ $V_{CE} = 4V$			2.7 2.7	V V
$V_{CE(sat)}^*$	Collector-emitter Saturation Voltage	for 2N3771 $I_C = 15A$ $I_B = 1.5A$ $I_C = 30A$ $I_B = 6A$ for 2N3772 $I_C = 10A$ $I_B = 1A$ $I_C = 20A$ $I_B = 4A$			2 4 1.4 4	V V V V
f_T	Transistion Frequency	$I_C = 1A$ $V_{CE} = 4V$; $f = 50KHz$	0.2			MHz
h_{FE}	Small Signal Current Gain	$I_C = 1A$ $V_{CE} = 4V$ $f = 1KHz$	40			
$I_{s\ b}$	Second Breakdown Collector Current	$V_{CE} = 25V$ $t = 1\ s$ (non repetitive)	6			A

* Pulsed : pulse duration = 300µs. duty cycle ≤ 2%.

Safe Operating Areas

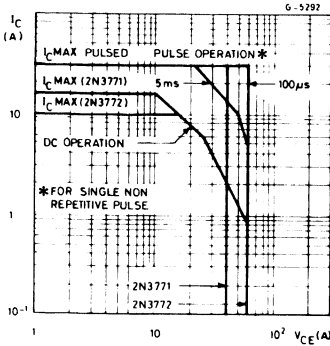

DC Current Gain.

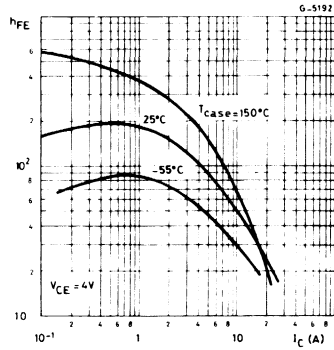

Saturation Voltage.

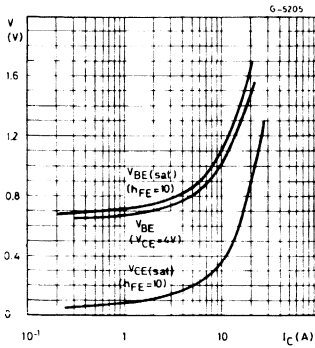

Collector-emitter Saturation Vol-

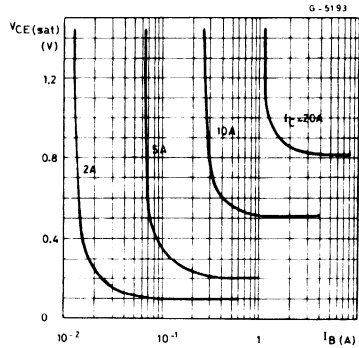

Capacitances.

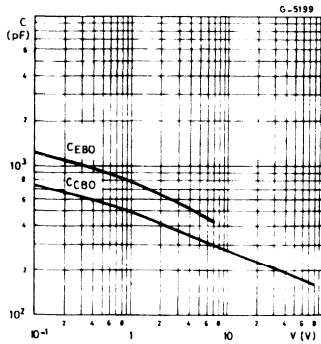

Turn-off Time.

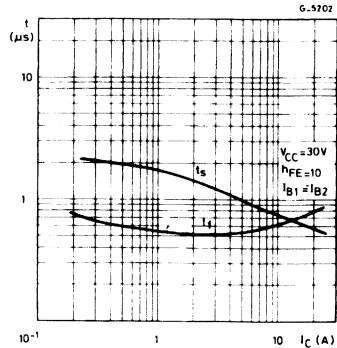

Turn-on Time.

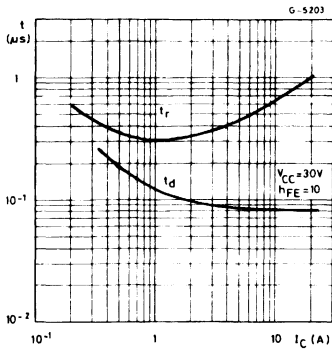

MEDIUM POWER GENERAL PURPOSE TRANSISTORS

DESCRIPTION

The 2N4234, 2N4235 and 2N4236 are silicon epitaxial planar PNP transistors mounted in Jedec TO-39 metal case.

They are intended for use in switching and amplifier applications.

The complementary NPN types are the 2N4237, and 2N4238 and 2N4239 respectively.

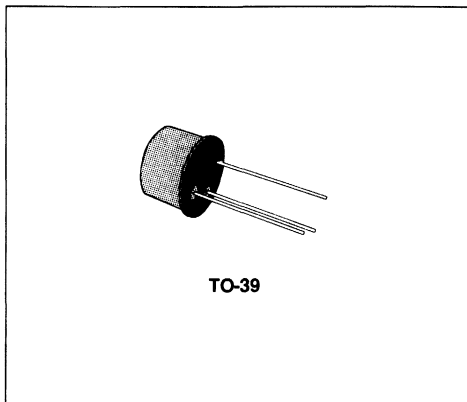

INTERNAL SCHEMATIC DIAGRAM

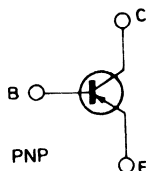

ABSOLUTE MAXIMUM RATINGS

Symbol	Parameter	2N4234	2N4235	2N4236	Unit
V_{CBO}	Collector-base Voltage ($I_E = 0$)	- 40	- 60	- 80	V
V_{CEO}	Collector-emitter Voltage ($I_B = 0$)	- 40	- 60	- 80	V
V_{EBO}	Emitter-base Voltage ($I_C = 0$)	- 7			V
I_C	Collector Current	- 3			A
I_B	Base Current	- 0.2			A
P_{tot}	Total Power Dissipation at $T_{case} \leq 25^\circ C$ $T_{amb} \leq 25^\circ C$	6			W
		1			W
T_{stg}	Storage Temperature	- 65 to 200			$^\circ C$
T_j	Junction Temperature	200			$^\circ C$

THERMAL DATA

$R_{th\ j-case}$	Thermal Resistance Junction-case	Max	29	°C/W
$R_{th\ j-amb}$	Thermal Resistance Junction-ambient	Max	175	°C/W

ELECTRICAL CHARACTERISTICS ($T_{case} = 25^{\circ}C$ unless otherwise specified)

Symbol	Parameter	Test Conditions	Min.	Typ.	Max.	Unit
I_{CBO}	Collector Cutoff Current ($I_E = 0$)	for 2N4234 $V_{CE} = -40V$ for 2N4235 $V_{CE} = -60V$ for 2N4236 $V_{CE} = -80V$			- 0.1 - 0.1 - 0.1	mA mA mA
I_{CEV}	Collector Cutoff Current ($V_{BE} = 1.5$)	for 2N4234 $V_{CE} = -40V$ for 2N4235 $V_{CE} = -60V$ for 2N4236 $V_{CE} = -80V$ $T_{case} = 150^{\circ}C$ for 2N4234 $V_{CE} = -30V$ for 2N4235 $V_{CE} = -40V$ for 2N4236 $V_{CE} = -60V$			- 0.1 - 0.1 - 0.1 - 1 - 1 - 1	mA mA mA mA mA mA
I_{CEO}	Collector Cutoff Current ($I_B = 0$)	for 2N4234 $V_{CE} = -30V$ for 2N4235 $V_{CE} = -40V$ for 2N4236 $V_{CE} = -60V$			- 1 - 1 - 1	mA mA mA
I_{EBO}	Emitter Cutoff Current ($I_C = 0$)	$V_{EB} = 7V$			- 0.5	mA
$V_{CEO(sus)}^*$	Collector-emitter Sustaining Voltage ($I_B = 0$)	$I_C = -100mA$ for 2N4234 for 2N4235 for 2N4236	- 40 - 60 - 80			V V V
$V_{CE(sat)}^*$	Collector-emitter Saturation Voltage	$I_C = -1A$ $I_B = -100mA$			- 0.6	V
$V_{BE(sat)}^*$	Base-emitter Saturation Voltage	$I_C = -1A$ $I_B = -100mA$			- 1.5	V
V_{BE}^*	Base-emitter Voltage	$I_C = -0.25A$ $V_{CE} = -1V$			- 1	V
h_{FE}^*	DC Current Gain	$I_C = -100mA$ $V_{CE} = -1V$ $I_C = -250mA$ $V_{CE} = -1V$ $I_C = -500mA$ $V_{CE} = -1V$ $I_C = -1A$ $V_{CE} = -1V$	40 30 20 10		150	
f_T	Transistion Frequency	$I_C = -100mA$ $V_{CE} = -10V$ $f = 1MHz$	3			MHz
C_{CBO}	Collector-base Capacitance	$I_E = 0$ $V_{CB} = -10V$ $f = 100KHz$			100	pF
h_{fe}	Small Signal Current Gain	$I_C = -50mA$ $V_{CE} = -10V$ $f = 1KHz$	25			

* Pulsed : pulse duration = 300µs, duty cycle ≤ 2%.

HIGH CURRENT, FAST SWITCHING APPLICATIONS

DESCRIPTION

The 2N4895, 2N4896 and 2N4897 are silicon epitaxial planar NPN transistors in Jedec TO-3 metal case.

They are intended for high current, fast switching applications and for power amplifiers.

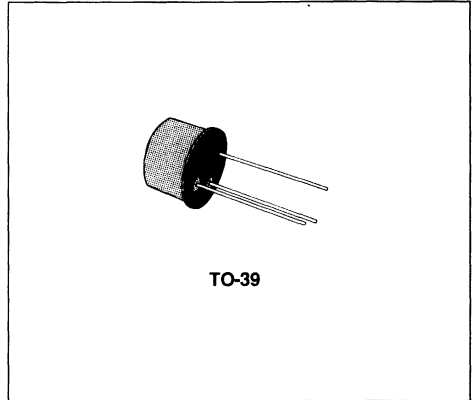

INTERNAL SCHEMATIC DIAGRAM

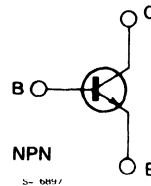

ABSOLUTE MAXIMUM RATINGS

Symbol	Parameter	2N4895	2N4896	2N4897	Unit
V_{CBO}	Collector-base Voltage ($I_E = 0$)	120	120	150	V
V_{CEO}	Collector-emitter Voltage ($I_B = 0$)	60	60	80	V
V_{EBO}	Emitter-base Voltage ($I_C = 0$)	6			V
I_C	Collector Current	5			A
P_{tot}	Total Power Dissipation at $T_{amb} \leq 25^\circ C$	1			W
	$T_{case} \leq 25^\circ C$	7			W
	$T_{case} \leq 100^\circ C$	4			W
T_{stg}	Storage Temperature	- 65 to 200			$^\circ C$
T_j	Junction Temperature	200			$^\circ C$

THERMAL DATA

$R_{th\ j-case}$	Thermal Resistance Junction-case	Max	25	°C/W
$R_{th\ j-amb}$	Thermal Resistance Junction-ambient	Max	175	°C/W

ELECTRICAL CHARACTERISTICS ($T_{case} = 25^{\circ}C$ unless otherwise specified)

Symbol	Parameter	Test Conditions	Min.	Typ.	Max.	Unit
I_{CES}	Collector Cutoff Current ($V_{BE} = 0$)	for 2N4895 and 2N4896 $V_{CE} = 120V$ $V_{CE} = 60V$ $V_{CE} = 60V$ $T_{case} = 150^{\circ}C$ for 2N4897 $V_{CE} = 150V$ $V_{CE} = 100V$ $V_{CE} = 100V$ $T_{case} = 150^{\circ}C$			1 1 100 1 1 100	mA μA μA mA μA μA
I_{EBO}	Emitter Cutoff Current ($I_C = 0$)	$V_{EB} = 6V$			1	mA
$V_{CEO(sus)}^*$	Collector-emitter Sustaining Voltage ($I_B = 0$)	$I_C = 50mA$ for 2N4895 and 2N4896 for 2N4897	60 80			V V
$V_{CE(sat)}^*$	Collector-emitter Saturation Voltage	$I_C = 5A$ $I_B = 0.5A$			1	V
$V_{BE(sat)}^*$	Base-emitter Saturation Voltage	$I_C = 5A$ $I_B = 0.5A$			1.6	V
h_{FE}^*	DC Current Gain	$I_C = 2A$ $V_{CE} = 2V$ for 2N4895 and 2N4897 for 2N4896 $I_C = 2A$ $V_{CE} = 2V$ $T_{case} = -55^{\circ}C$ for 2N4895 and 2N4897 for 2N4896	40 100 15 35		120 300	
f_T	Transistion Frequency	$I_C = 0.5A$ $V_{CE} = 5V$ for 2N4895 and 2N4897 for 2N4896	50 80			MHz MHz
C_{CBO}	Collector-base Capacitance	$I_E = 0$ $V_{CB} = 10V$ $f = 1\ MHz$			80	pF
t_{on}	Turn-on Time	$I_C = 5A$ $V_{CC} = 20V$ $I_{B1} = 0.5A$			0.35	μs
t_s	Storage Time	$I_C = 5A$ $V_{CC} = 20V$			0.35	μs
t_f	Fall Time	$I_{B1} = -I_{B2} = 0.5A$			0.3	μs

* Pulsed : pulse duration = 300μs, duty cycle = 1.5%.

Safe Operating Areas

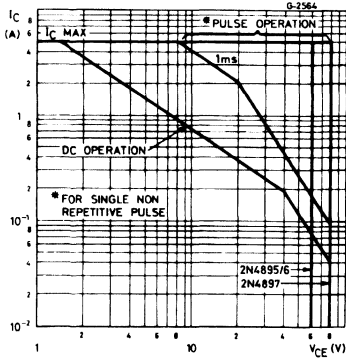

DC Current Gain.

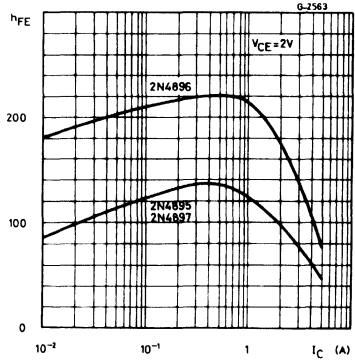

DC Transconductance.

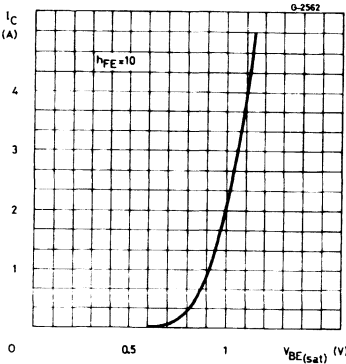

Collector-emitter Saturation Voltage.

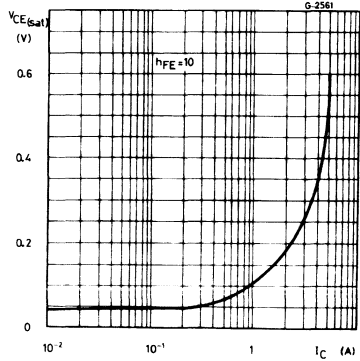

Transition Frequency.

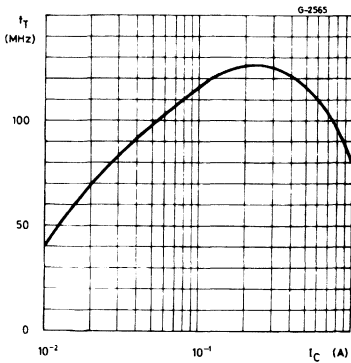

Collector-base Capacitance.

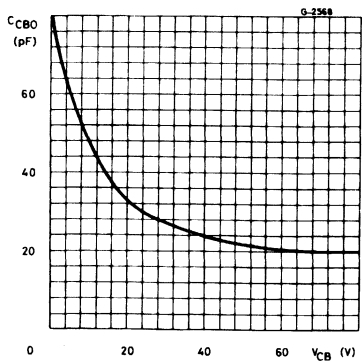

Saturated Switching Characteristics.

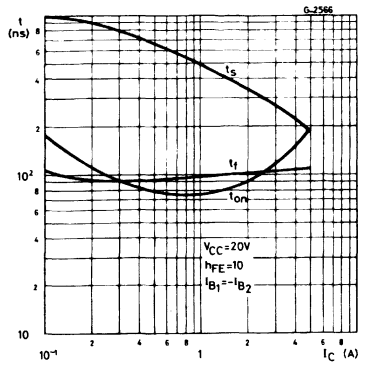

Power Rating Chart.

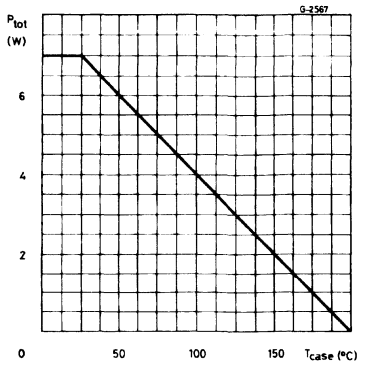

MEDIUM POWER LINEAR AND SWITCHING APPLICATIONS

DESCRIPTION

The 2N4921, 2N4922 and 2N4923 are silicon epitaxial planar NPN transistors in Jedge TO-126 plastic package, they are intended for driver circuits, switching and amplifier applications. The complementary PNP types are the 2N4918, 2N4919 and 2N4920 respectively.

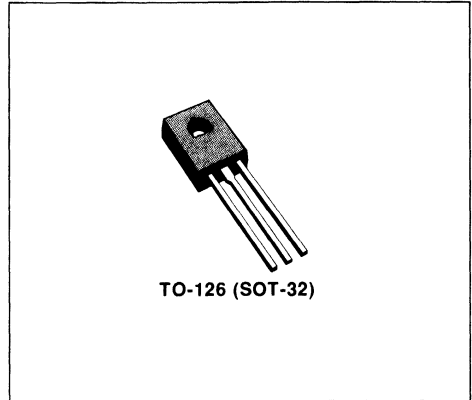

INTERNAL SCHEMATIC DIAGRAMS

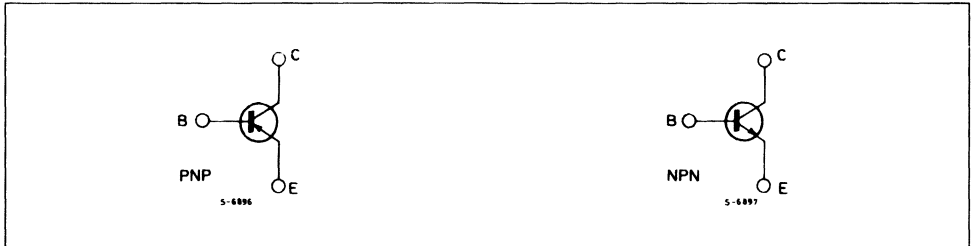

ABSOLUTE MAXIMUM RATINGS

Symbol	Parameter	PNP	2N4918	2N4919	2N4920	Unit
		NPN	2N4921	2N4922	2N4923	
V_{CEO}	Collector-emitter Voltage ($I_B = 0$)		40	60	80	V
V_{CBO}	Collector-base Voltage ($I_E = 0$)		40	60	80	V
V_{EBO}	Emitter-base Voltage ($I_C = 0$)		5			V
I_C	Collector Current		1			A
I_{CM}	Collector Peak Current		3			A
I_B	Base Current		1			A
P_{tot}	Total Power Dissipation at $T_{case} \leq 25^\circ C$		30			W
T_{stg}	Storage Temperature		- 65 to 150			$^\circ C$
T_j	Junction Temperature		150			$^\circ C$

* For PNP types voltage and current values are negative.

THERMAL DATA

$R_{th\ j-case}$	Thermal Resistance Junction-case	Max	4.16	°C/W
------------------	----------------------------------	-----	------	------

ELECTRICAL CHARACTERISTICS ($T_{case} = 25\text{ °C}$ unless otherwise specified)

Symbol	Parameter	Test Conditions	Min.	Typ.	Max.	Unit
I_{CEO}	Collector Cutoff Current ($I_{BO} = 0$)	$V_{CE} = \text{Half rated } V_{CEO}$			0.5	mA
I_{CEX}	Collector Cutoff Current ($V_{BE} = -1.5\text{ V}$)	$V_{CE} = \text{rated } V_{CEO}$ $V_{CE} = \text{rated } V_{CEO}$ $T_{case} = 125\text{ °C}$			0.1 0.5	mA mA
I_{CBO}	Collector Cutoff Current ($I_E = 0$)	$V_{CE} = \text{rated } V_{CBO}$			0.1	mA
I_{EBO}	Emitter Cutoff Current ($I_C = 0$)	$V_{EB} = 5\text{ V}$			1	mA
$V_{CEO(sus)}^*$	Collector-emitter Sustaining Voltage	$I_C = 0.1\text{ A}$ for 2N4918, 2N4921 for 2N4919, 2N4922 for 2N4920, 2N4923	40 60 80			V V V
h_{FE}^*	DC Current Gain	$I_C = 50\text{ mA}$ $V_{CE} = 1\text{ V}$ $I_C = 500\text{ mA}$ $V_{CE} = 1\text{ V}$ $I_C = 1\text{ A}$ $V_{CE} = 1\text{ V}$	40 30 10		150	
$V_{CE(sat)}^*$	Collector-emitter Saturation Voltage	$I_C = 1\text{ A}$ $I_B = 0.1\text{ A}$			0.6	V
$V_{BE(sat)}^*$	Base-emitter Saturation Voltage	$I_C = 1\text{ A}$ $I_B = 0.1\text{ A}$			1.3	V
V_{BE}^*	Base Emitter Voltage	$I_C = 1\text{ A}$ $V_{CE} = 1\text{ V}$			1.3	V
f_T	Transistion Frequency	$I_C = 250\text{ mA}$ $V_{CE} = 10\text{ V}$ $f = 1\text{ MHz}$	3			MHz
C_{CBO}	Collector-base Capacitance	$V_{CB} = 10\text{ V}$ $f = 100\text{ KHz}$ $I_E = 0$			100	pF
h_{FE}	Small Signal Current Gain	$I_C = 250\text{ mA}$ $V_{CE} = 10\text{ V}$ $f = 1\text{ KHz}$	25			

* Pulsed : pulse duration = 300µs duty cycle ≤ 2%.
For NPN types voltage and current values are negative.

Safe Operating Areas.

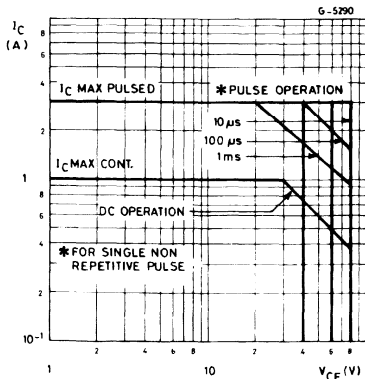

DC Current Gain (NPN types).

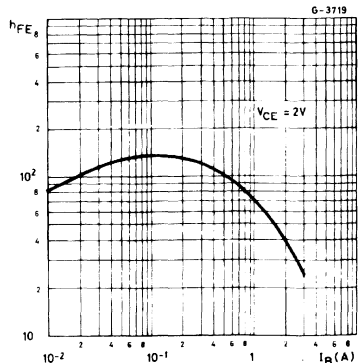

DC Current Gain (PNP types).

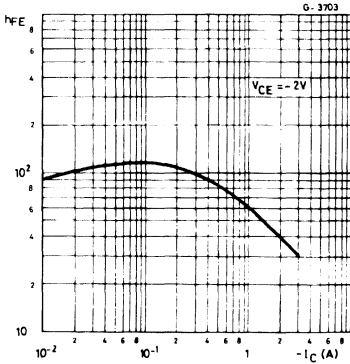

DC Transconductance (NPN types).

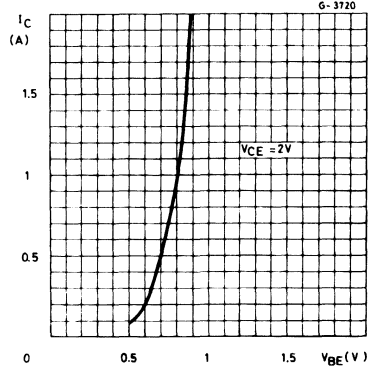

DC Transconductance (PNP types).

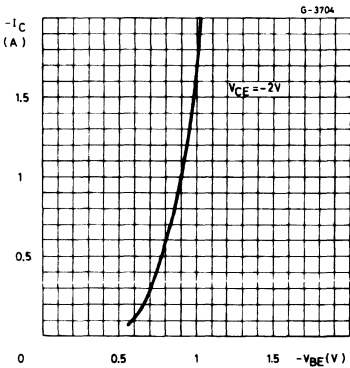

Collector-emitter Saturation Voltage (NPN types).

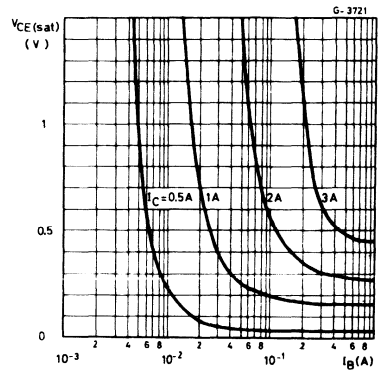

Collector-emitter Saturation Voltage (NPN types).

Collector-emitter Saturation Voltage (PNP types).

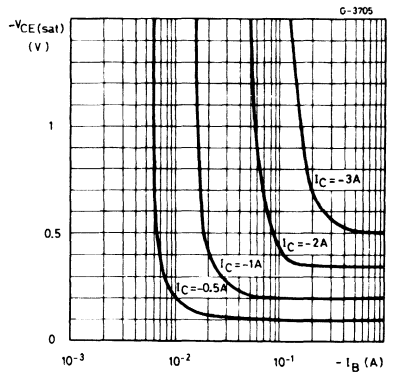
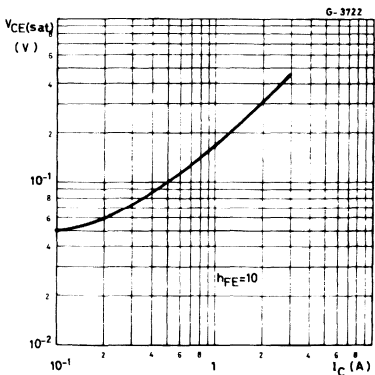

Collector-emitter Saturation Voltage (PNP types).

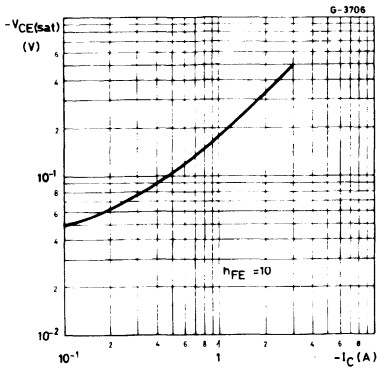

Base-emitter Saturation Voltage (NPN types).

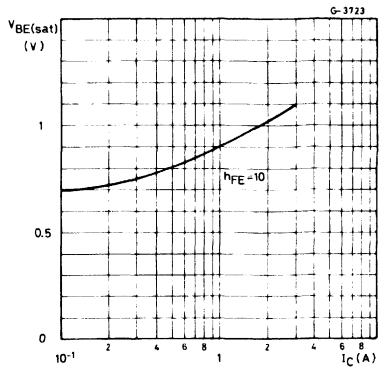

Base-emitter Saturation Voltage (PNP types).

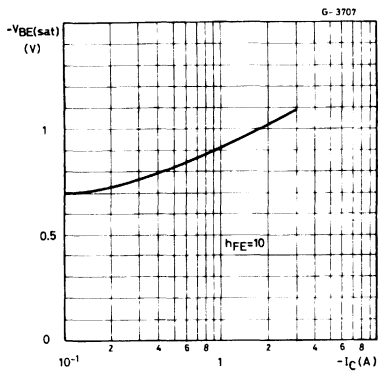

Saturated Switching Characteristics (NPN types).

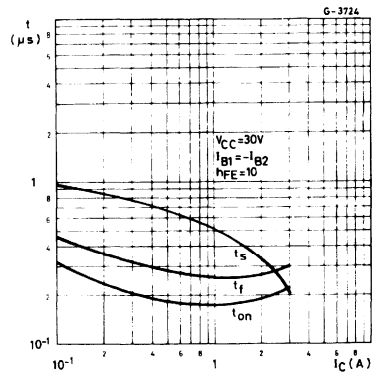

Saturated Switching Characteristics (PNP types).

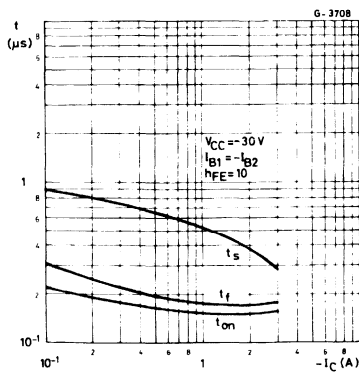

HIGH CURRENT POWER SWITCH

DESCRIPTION

The 2N5038, 2N5039 and 2N6496 are silicon planar multi-epitaxial NPN transistors in Jedec TO-3 metal case.

They are especially intended for high current and fast switching applications.

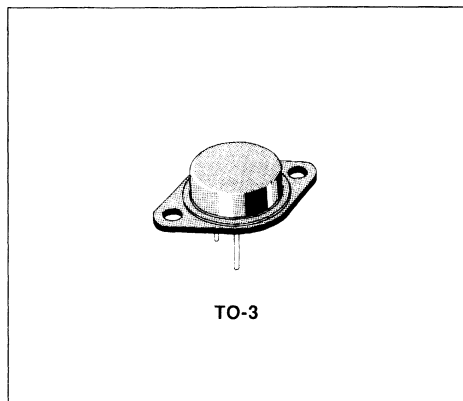

INTERNAL SCHEMATIC DIAGRAM

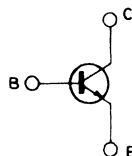

ABSOLUTE MAXIMUM RATINGS

Symbol	Parameter	2N5038	2N5039	2N6496	Unit
V_{CBO}	Collector-base Voltage ($I_E = 0$)	150	120	150	V
V_{CEX}	Collector-emitter Voltage ($V_{BE} = -1.5$ V, $R_{BE} = 100 \Omega$)	150	120	150	V
V_{CER}	Collector-emitter Voltage ($R_{BE} \leq 50 \Omega$)	110	95	130	V
V_{CEO}	Collector-emitter Voltage ($I_B = 0$)	90	75	110	V
V_{EBO}	Emitter-Base Voltage ($I_C = 0$)	7	7	7	V
I_C	Collector Current	20	20	15	V
I_{CM}	Collector Peak Current	30	30		V
I_B	Base Current	5			A
P_{tot}	Total Power Dissipation at $T_{case} \leq 25^\circ\text{C}$	140			W
T_{stg}	Storage Temperature	- 65 to 200			$^\circ\text{C}$
T_j	Junction Temperature	200			$^\circ\text{C}$

THERMAL DATA

$R_{th\ j-case}$	Thermal Resistance Junction-case	Max	1.25	°C/W
------------------	----------------------------------	-----	------	------

ELECTRICAL CHARACTERISTICS ($T_{case} = 25\text{ °C}$ unless otherwise specified)

Symbol	Parameter	Test Conditions	Min.	Typ.	Max.	Unit
I_{CEV}	Collector Cutoff Current ($V_{BE} = -1.5\text{ V}$)	for 2N5038 $V_{CE} = 140\text{ V}$ $V_{CE} = 100\text{ V}$ $T_{case} = 150\text{ °C}$ for 2N5039 $V_{CE} = 110\text{ V}$ $V_{CE} = 85\text{ V}$ $T_{case} = 150\text{ °C}$ for 2N6496 $V_{CE} = 130\text{ V}$ $V_{CE} = 130\text{ V}$ $T_{case} = 150\text{ °C}$			50 10	mA mA
I_{CEO}	Collector Cutoff Current ($I_B = 0$)	for 2N5038 $V_{CE} = 70\text{ V}$ for 2N5039 $V_{CE} = 55\text{ V}$			20 20	mA mA
I_{EBO}	Emitter Cutoff Current ($I_C = 0$)	$V_{EB} = 7\text{ V}$ $V_{EB} = 5\text{ V}$ for 2N5038 for 2N5039			50 5 15	mA mA mA
$V_{CEX(sus)}^*$	Collector-emitter Sustaining Voltage ($V_{BE} = -1.5\text{ V}$, $R_{BE} = 100\ \Omega$)	$I_C = 200\text{ mA}$ for 2N5038 for 2N5039 for 2N6496	150 120 150			V V V
$V_{CER(sus)}^*$	Collector-emitter Sustaining Voltage ($R_{BE} = 50\ \Omega$)	$I_C = 200\text{ mA}$ for 2N5038 for 2N5039 for 2N6496	110 95 130			V V V
$V_{CEO(sus)}^*$	Collector-emitter Sustaining Voltage ($I_B = 0$)	$I_C = 200\text{ mA}$ for 2N5038 for 2N5039 for 2N6496	90 75 110			V V V
$V_{CE(sat)}^*$	Collector-emitter Saturation Voltage	for 2N5038 $I_C = 12\text{ A}$ $I_B = 1.2\text{ A}$ $I_C = 20\text{ A}$ $I_B = 5\text{ A}$ for 2N5039 $I_C = 10\text{ A}$ $I_B = 1\text{ A}$ $I_C = 20\text{ A}$ $I_B = 5\text{ A}$ for 2N6496 $I_C = 8\text{ A}$ $I_B = 0.8\text{ A}$			1 2.5	V V
$V_{BE(sat)}^*$	Base-emitter Saturation Voltage	for 2N5038 and 2N5039 $I_C = 20\text{ A}$ $I_B = 5\text{ A}$ for 2N6496 $I_C = 8\text{ A}$ $I_B = 0.8\text{ A}$			3.3 2	V V
V_{BE}^*	Base-emitter Voltage	for 2N5038 $I_C = 12\text{ A}$ $V_{CE} = 5\text{ V}$ for 2N5039 $I_C = 10\text{ A}$ $V_{CE} = 5\text{ V}$ for 2N6496 $I_C = 8\text{ A}$ $V_{CE} = 2\text{ V}$			1.8 1.8 1.6	V V V

ELECTRICAL CHARACTERISTICS (continued)

Symbol	Parameter	Test Conditions	Min.	Typ.	Max.	Unit
h_{FE}^*	DC Current Gain	for 2N5038 $I_C = 2\text{ A}$ $V_{CE} = 5\text{ V}$ $I_C = 12\text{ A}$ $V_{CE} = 5\text{ V}$ for 2N5039 $I_C = 2\text{ A}$ $V_{CE} = 5\text{ V}$ $I_C = 10\text{ A}$ $V_{CE} = 5\text{ V}$ for 2N6496 $I_C = 8\text{ A}$ $V_{CE} = 2\text{ V}$	50 20		250 100	
h_{fe}	Small Signal Current Gain	$I_C = 2\text{ A}$ $V_{CE} = 10\text{ V}$ $f = 5\text{ MHz}$	12			
C_{CBO}	Collector-base Capacitance	$I_E = 0$ $V_{CB} = 10\text{ V}$ $f = 1\text{ MHz}$			300	pF
t_r	Rise Time	for 2N5038 $I_C = 12\text{ A}$ $V_{CC} = 30\text{ V}$ $I_{B1} = -I_{B2} = 1.2\text{ A}$			0.5	μs
t_s	Storage Time	for 2N5039 $I_C = 10\text{ A}$ $V_{CC} = 30\text{ V}$ $I_{B1} = -I_{B2} = 1\text{ A}$			1.5	μs
t_f	Fall Time	for 2N6496 $I_C = 8\text{ A}$ $V_{CC} = 30\text{ V}$ $I_{B1} = -I_{B2} = 0.8\text{ A}$			0.5	μs
$I_{S/b}^{**}$	Second Breakdown Collector Current	$V_{CE} = 28\text{ V}$ $V_{CE} = 45\text{ V}$	5 0.9			A A
$E_{S/b}$	Second Breakdown Energy	$V_{BE} = -4\text{ V}$ $R_{BE} = 20\ \Omega$ $L = 180\ \mu\text{H}$ for 2N5038 for 2N5039 for 2N6496	13 13 5.7			mJ mJ mJ

* Pulsed : pulse duration = 300 μs duty cycle = 1.5%.
 ** Pulsed : 1 s non repetitive pulse.

Safe Operating Areas (for 2N5038 and 2N5039).

Safe Operating Areas (for 2N6496).

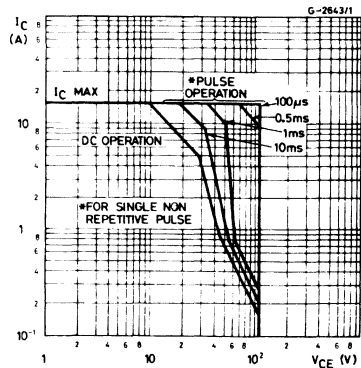
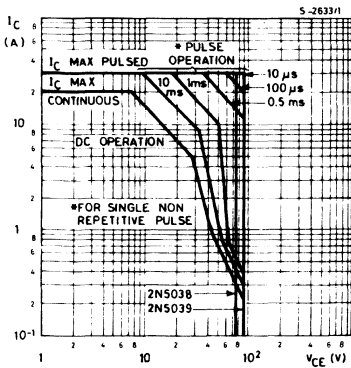

DC Current Gain.

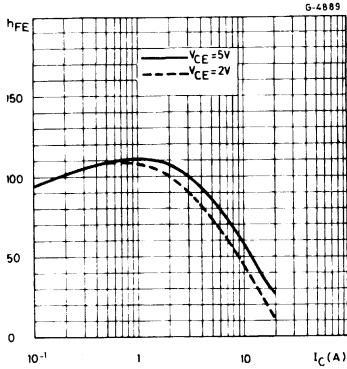

Collector-emitter Saturation Voltage.

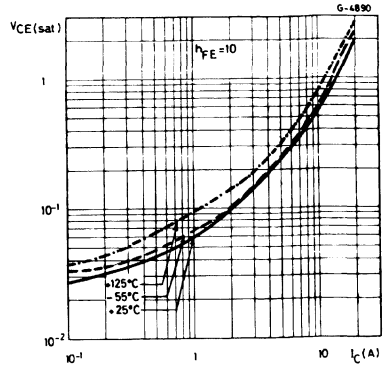

Collector-emitter Saturation Voltage.

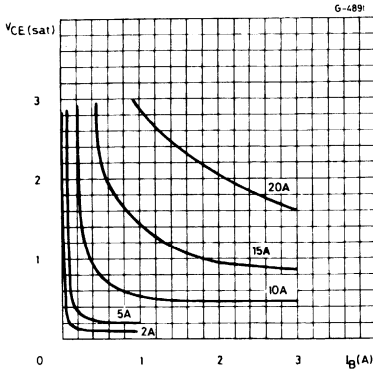

Base-emitter Saturation Voltage.

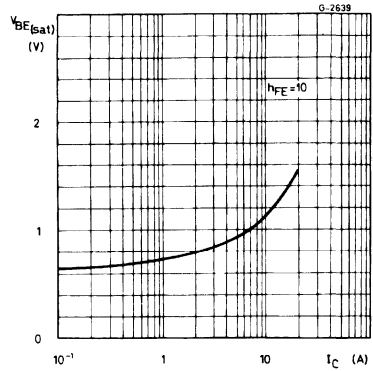

$V_{BE(on)}$ vs. Collector Current.

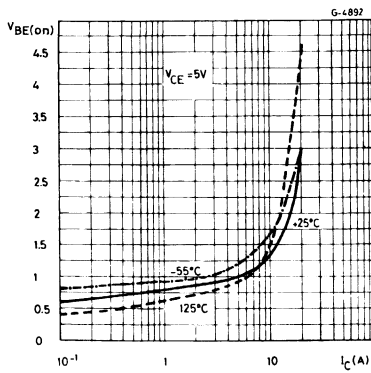

Saturated Switching Characteristics.

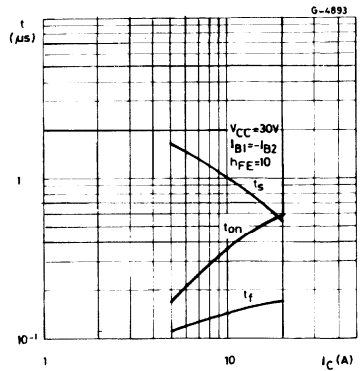

Collector-base Capacitance.

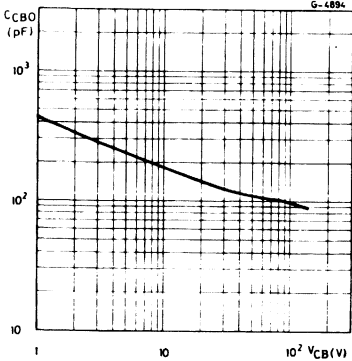

Transition Frequency.

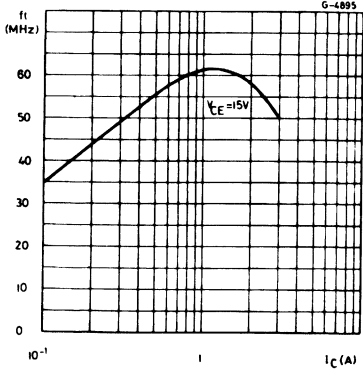

HIGH SPEED MEDIUM VOLTAGE SWITCHES

DESCRIPTION

The 2N5151 and 2N5153 are silicon epitaxial planar PNP transistors in Jedec TO-39 metal case intended for use in switching applications.

The complementary NPN types are the 2N5152 and 2N5154 respectively.

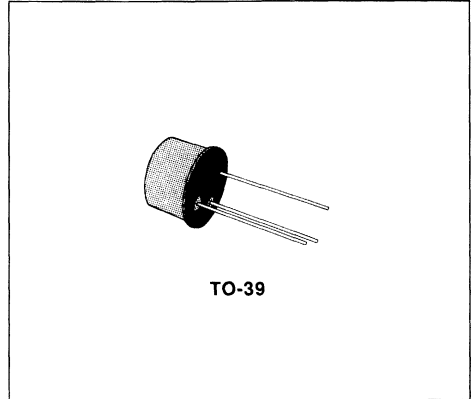

INTERNAL SCHEMATIC DIAGRAM

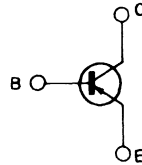

ABSOLUTE MAXIMUM RATINGS

Symbol	Parameter	Value		Unit
		2N5151	2N5153	
V_{CBO}	Collector-base Voltage ($I_E = 0$)	- 100		V
V_{CEO}	Collector-emitter Voltage ($I_B = 0$)	- 80		V
V_{EBO}	Emitter-base Voltage ($I_C = 0$)	- 5.5		V
I_C	Collector Current	- 5		A
I_{CM}	Collector Peak Current	- 10		A
I_B	Base Current	- 2.5		A
P_{tot}	Total Power Dissipation at $T_{case} \leq 50\text{ }^\circ\text{C}$ $T_{case} \leq 100\text{ }^\circ\text{C}$ $T_{amb} \leq 25\text{ }^\circ\text{C}$	10		W
		6.7		W
		1		W
T_{stg}	Storage Temperature	- 65 to 200		$^\circ\text{C}$
T_j	Junction Temperature	200		$^\circ\text{C}$

THERMAL DATA

$R_{th\ j-case}$	Thermal Resistance Junction-case	Max	15	°C/W
$R_{th\ j-amb}$	Thermal Resistance Junction-ambient	Max	175	°C/W

ELECTRICAL CHARACTERISTICS ($T_{case} = 25\text{ °C}$ unless otherwise specified)

Symbol	Parameter	Test Conditions	Min.	Typ.	Max.	Unit
I_{CES}	Collector Cutoff Current ($V_{BE} = 0$)	$V_{CE} = -60\text{ V}$ $V_{CE} = -100\text{ V}$			-1 -1	μA mA
I_{CEV}	Collector Cutoff Current ($V_{BE} = 2\text{ V}$)	$V_{CE} = -60\text{ V}$ $T_{case} = 150\text{ °C}$			-500	μA
I_{CEO}	Collector Cutoff Current ($I_B = 0$)	$V_{CE} = -40\text{ V}$			-50	μA
I_{EBO}	Emitter Cutoff Current ($I_C = 0$)	$V_{EB} = -4\text{ V}$ $V_{EB} = -5.5\text{ V}$			-1 -1	μA mA
$V_{CEO(sus)}^*$	Collector-emitter Sustaining Voltage ($I_B = 0$)	$I_C = -100\text{ mA}$	-80			V
$V_{CE(sat)}^*$	Collector-emitter Saturation Voltage	$I_C = -2.5\text{ A}$ $I_B = -250\text{ mA}$ $I_C = -5\text{ A}$ $I_B = -500\text{ mA}$			-0.75 -1.5	V V
$V_{BE(sat)}^*$	Base-emitter Saturation Voltage	$I_C = -2.5\text{ A}$ $I_B = -250\text{ mA}$ $I_C = -5\text{ A}$ $I_B = -500\text{ mA}$			-1.45 -2.2	V V
V_{BE}^*	Base-emitter Voltage	$I_C = -2.5\text{ A}$ $V_{CE} = -5\text{ V}$			-1.45	V
h_{FE}^*	DC Current Gain	for 2N5151 $I_C = -50\text{ mA}$ $V_{CE} = -5\text{ V}$ 20 $I_C = -2.5\text{ A}$ $V_{CE} = -5\text{ V}$ 30 $I_C = -5\text{ A}$ $V_{CE} = -5\text{ V}$ 20 $T_{case} = -55\text{ °C}$ $I_C = 2.5\text{ A}$ $V_{CE} = -5\text{ V}$ 15 for 2N5153 $I_C = -50\text{ mA}$ $V_{CE} = -5\text{ V}$ 50 $I_C = -2.5\text{ A}$ $V_{CE} = -5\text{ V}$ 70 $I_C = -5\text{ mA}$ $V_{CE} = -5\text{ V}$ 40 $T_{case} = -55\text{ °C}$ $I_C = 2.5\text{ A}$ $V_{CE} = -5\text{ V}$ 35			90 200	
C_{CBO}	Collector-base Capacitance	$I_E = 0$ $f = 1\text{ MHz}$ $V_{CB} = -10\text{ V}$			250	pF
h_{fe}	Small Signal Current Gain	$I_C = -0.1\text{ A}$ $V_{CE} = -5\text{ V}$ $f = 1\text{ KHz}$ for 2N5151 for 2N5153 $I_C = -0.5\text{ A}$ $V_{CE} = -5\text{ V}$ $f = 20\text{ MHz}$ for 2N5151 for 2N5153			20 50 3 3.5	
t_{on}	Turn on Time	$I_C = -5\text{ A}$ $I_{B1} = -0.5\text{ A}$ $V_{CC} = 30\text{ V}$		0.5		μs
t_{off}	Turn off Time	$I_C = -5\text{ A}$ $I_{B1} = -I_{B2} = 0.5\text{ A}$ $V_{CC} = 30\text{ V}$		1.3		μs

* Pulsed : pulse duration = 300 μs , duty cycle $\leq 2\%$.

HIGH SPEED MEDIUM VOLTAGE SWITCHES

DESCRIPTION

The 2N5152 and 2N5154 are silicon epitaxial planar NPN transistors in Jedec TO-39 metal case intended for use in switching applications.

The complementary PNP types are the 2N5151, and 2N5153 respectively.

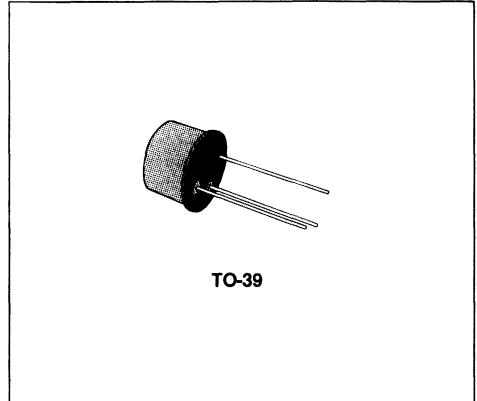

INTERNAL SCHEMATIC DIAGRAM

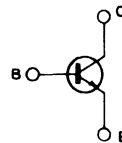

ABSOLUTE MAXIMUM RATINGS

Symbol	Parameter	Value	Unit	
V_{CBO}	Collector-base Voltage ($I_E = 0$)	100	V	
V_{CEO}	Collector-emitter Voltage ($I_B = 0$)	80	V	
V_{EBO}	Emitter-base Voltage ($I_C = 0$)	6	V	
I_C	Collector Current	2	A	
I_{CM}	Collector Peak Current	10	A	
I_B	Base Current	1	A	
P_{tot}	Total Power Dissipation at	$T_{case} \leq 50^\circ\text{C}$	10	W
		$T_{case} \leq 100^\circ\text{C}$	6.7	W
		$T_{amb} \leq 25^\circ\text{C}$	1	W
T_{stg}	Storage Temperature	- 65 to 200	$^\circ\text{C}$	
T_j	Junction Temperature	200	$^\circ\text{C}$	

THERMAL DATA

$R_{th\ j-case}$	Thermal Resistance Junction-case	Max	15	°C/W
$R_{th\ j-amb}$	Thermal Resistance Junction-ambient	Max	175	°C/W

ELECTRICAL CHARACTERISTICS ($T_{case} = 25^{\circ}C$ unless otherwise specified)

Symbol	Parameter	Test Conditions	Min.	Typ.	Max.	Unit
I_{CES}	Collector Cutoff Current ($V_{BE} = 0$)	$V_{CE} = 60V$ $V_{CE} = 100V$			1 1	μA mA
I_{CEV}	Collector Cutoff Current ($V_{BE} = -2V$)	$V_{CE} = 60V$ $T_{case} = 150^{\circ}C$			500	μA
I_{CEO}	Collector Cutoff Current ($I_B = 0$)	$V_{CE} = 40V$			50	μA
I_{EBO}	Emitter Cutoff Current ($I_C = 0$)	$V_{EB} = 5V$ $V_{EB} = 6V$			1 1	μA mA
$V_{CEO(sus)^*}$	Collector-emitter Sustaining Voltage ($I_B = 0$)	$I_C = 100mA$	80			V
$V_{CE(sat)^*}$	Collector-emitter Saturation Voltage	$I_C = 2.5A$ $I_B = 250mA$ $I_C = 5A$ $I_B = 500mA$			0.75 1.5	V V
$V_{BE(sat)^*}$	Base-emitter Saturation Voltage	$I_C = 2.5A$ $I_B = 250mA$ $I_C = 5A$ $I_B = 500mA$			1.45 2.2	V V
V_{BE}^*	Base-emitter Voltage	$I_C = 2.5A$ $V_{CE} = 5V$			1.45	V
h_{FE}^*	DC Current Gain	for 2N5152 $I_C = 50mA$ $V_{CE} = 5V$ $I_C = 2.5A$ $V_{CE} = 5V$ $I_C = 5A$ $V_{CE} = 5V$ $T_{case} = -55^{\circ}C$ $I_C = 2.5A$ $V_{CE} = 5V$ for 2N5154 $I_C = 50mA$ $V_{CE} = 5V$ $I_C = 2.5A$ $V_{CE} = 5V$ $I_C = 5A$ $V_{CE} = 5V$ $T_{case} = -55^{\circ}C$ $I_C = 2.5A$ $V_{CE} = 5V$	20 30 20 15 50 70 40 35		90 200	
C_{CBO}	Collector-base Capacitance	$I_E = 0$ $V_{CB} = 10V$ $f = 1MHz$			250	pF
h_{ie}	Small Signal Current Gain	$I_C = 0.1A$ $V_{CE} = 5V$ $f = 1KHz$ for 2N5152 for 2N5154 $I_C = 0.5A$ $V_{CE} = 5V$ $f = 20MHz$ for 2N5152 for 2N5154	20 50 3 3.5			
t_{on}	Turn on Time	$I_C = 5A$ $I_{B1} = 0.5 A$ $V_{CC} = 30V$		0.5		μs
t_{off}	Turn off Time	$I_C = 5A$ $I_{B1} = - I_{B2} = 0.5A$ $V_{CC} = 30V$		1.3		μs

* Pulsed : pulse duration = 300 μs , duty cycle \leq 2%.

MEDIUM POWER LINEAR AND SWITCHING APPLICATIONS

DESCRIPTION

The 2N5190, 2N5191, 2N5192 are silicon epitaxial-base NPN power transistors in Jedec TO-126 plastic package, intended for use in medium power linear and switching applications. The complementary PNP types are the 2N5193, 2N5194 and 2N5195 respectively.

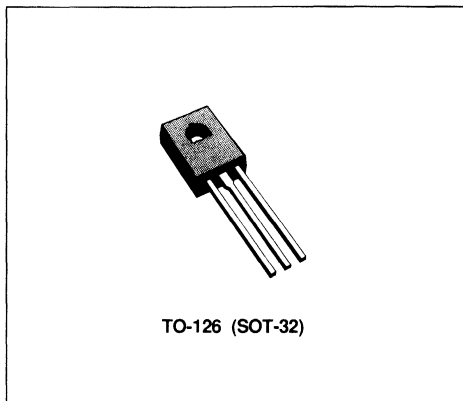

INTERNAL SCHEMATIC DIAGRAMS

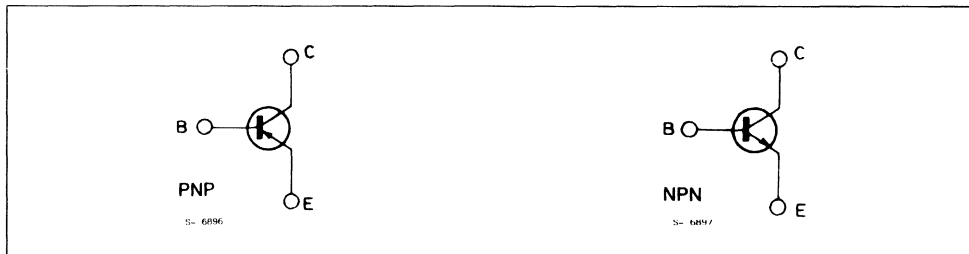

ABSOLUTE MAXIMUM RATINGS

Symbol	Parameter	NPN PNP*	2N5190 2N5193	2N5191 2N5194	2N5192 2N5195	Unit
V_{CBO}	Collector-base Voltage ($I_E = 0$)		40	60	80	V
V_{CEO}	Collector-emitter Voltage ($I_B = 0$)		40	60	80	V
V_{EBO}	Emitter-base Voltage ($I_C = 0$)		5			V
I_C	Collector Current		4			A
I_{CM}	Collector Peak Current ($t \leq 10$ ms)		7			A
I_B	Base Current		1			A
P_{tot}	Total Power Dissipation at $T_{case} \leq 25$ °C		40			W
T_{stg}	Storage Temperature		- 65 to 150			°C
T_j	Junction Temperature		150			°C

* For PNP types voltage and current values are negative.

THERMAL DATA

$R_{th\ j-case}$	Thermal Resistance Junction-case	Max	3.12	°C/W
$R_{th\ j-amb}$	Thermal Resistance Junction-ambient	Max	100	°C/W

ELECTRICAL CHARACTERISTICS ($T_{case} = 25\text{ °C}$ unless otherwise specified)

Symbol	Parameter	Test Conditions	Min.	Typ.	Max.	Unit
I_{CBO}	Collector Cutoff Current ($I_E = 0$)	for 2N5190/93 $V_{CB} = 40\text{ V}$ for 2N5191/94 $V_{CB} = 60\text{ V}$ for 2N5192/95 $V_{CB} = 80\text{ V}$			100 100 100	μA μA μA
I_{CEX}	Collector Cutoff Current ($V_{EB} = 1.5\text{ V}$)	for 2N5190/93 $V_{CE} = 40\text{ V}$ for 2N5191/94 $V_{CE} = 60\text{ V}$ for 2N5192/95 $V_{CE} = 80\text{ V}$ $T_{case} = 125\text{ °C}$ for 2N5190/93 $V_{CE} = 40\text{ V}$ for 2N5191/94 $V_{CE} = 60\text{ V}$ for 2N5192/95 $V_{CE} = 80\text{ V}$			100 100 100 2 2 2	μA μA μA mA mA mA
I_{CEO}	Collector Cutoff Current ($I_B = 0$)	for 2N5190/93 $V_{CE} = 40\text{ V}$ for 2N5191/94 $V_{CE} = 60\text{ V}$ for 2N5192/95 $V_{CE} = 80\text{ V}$			1 1 1	mA mA mA
I_{EBO}	Emitter Cutoff Current ($I_C = 0$)	$V_{EB} = 5\text{ V}$			1	mA
$V_{CEO(sus)}^*$	Collector-emitter Sustaining Voltage ($I_B = 0$)	$I_C = 100\text{ mA}$	for 2N5190/93 for 2N5191/94 for 2N5192/95	40 60 80		V V V
$V_{CE(sat)}^*$	Collector-emitter Saturation Voltage	$I_C = 1.5\text{ A}$ $I_B = 0.15\text{ A}$ $I_C = 4\text{ A}$ $I_B = 1\text{ A}$ for 2N5190/91/92 for 2N5193/94/95			0.6 1.4 1.2	V V V
V_{BE}^*	Base-emitter Voltage	$I_C = 1.5\text{ A}$ $V_{CE} = 2\text{ V}$			1.2	V
h_{FE}^*	DC Current Gain	$I_C = 1.5\text{ A}$ $V_{CE} = 2\text{ V}$ for 2N5190/93 for 2N5191/94 for 2N5192/95 $I_C = 4\text{ A}$ $V_{CE} = 2\text{ V}$ for 2N5190/93 for 2N5191/94 for 2N5192/95	25 25 20 10 10 7		100 100 80	
f_T	Transistion Frequency	$I_C = 1\text{ A}$ $V_{CE} = 10\text{ V}$	2			MHz

* Pulsed : pulse duration = 300 μs duty cycle = 1.5%.
For NPN types voltage and current values are negative.

Safe Operating Areas.

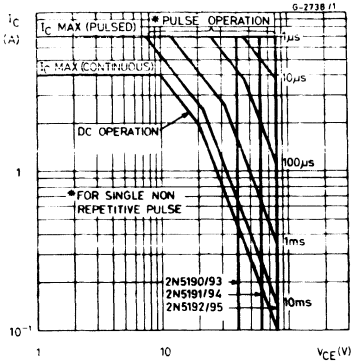

Power Rating Chart.

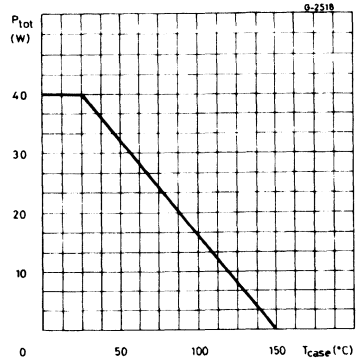

DC Current Gain (NPN types).

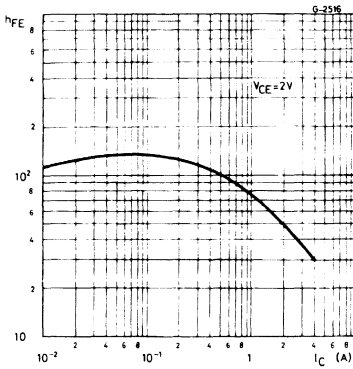

DC Current Gain (PNP types).

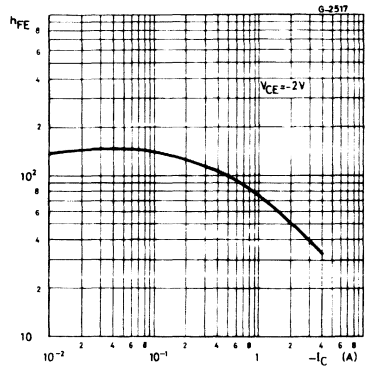

Collector-emitter Saturation Voltage (NPN types).

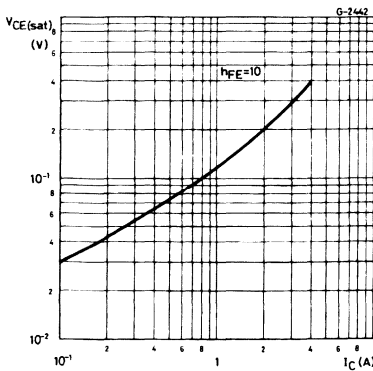

Collector-emitter Saturation Voltage (PNP types).

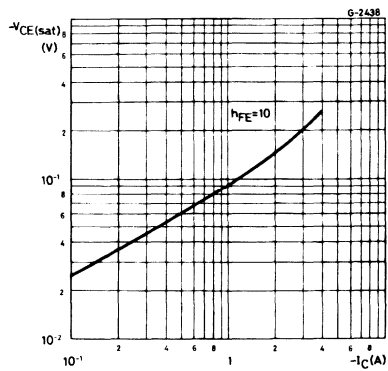

Base-emitter Saturation Voltage (NPN types).

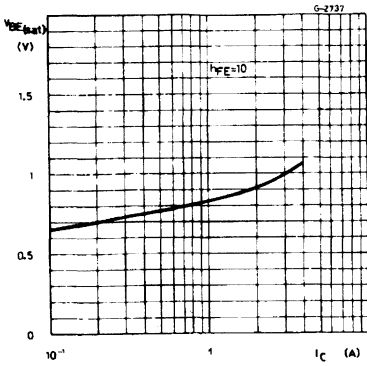

Base-emitter Saturation Voltage (PNP types).

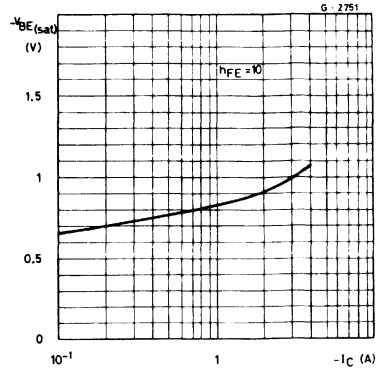

Collector-base Capacitance (NPN types).

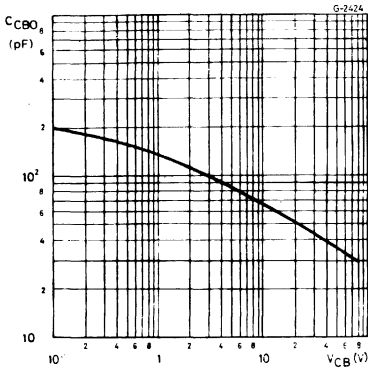

Collector-base Capacitance (PNP types).

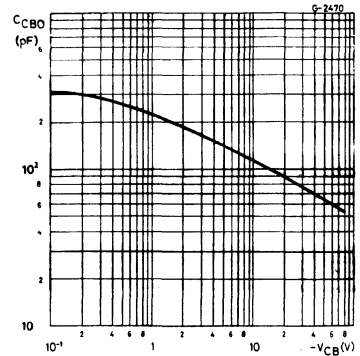

Transition Frequency (NPN types).

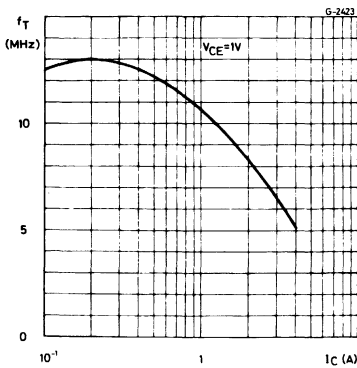

Transition Frequency (PNP types).

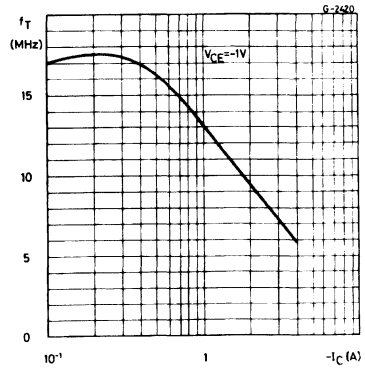

Saturated Switching Characteristics (NPN types).

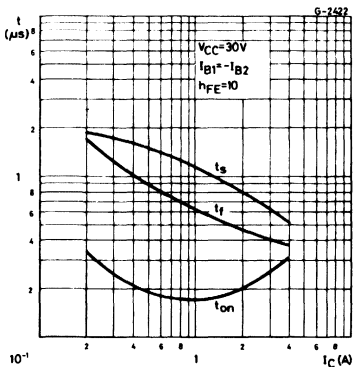

Saturated Switching Characteristics (PNP types).

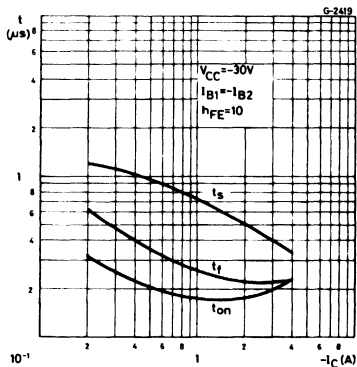

MEDIUM POWER LINEAR AND SWITCHING APPLICATIONS

DESCRIPTION

The 2N5301/2/3, are silicon epitaxial-base NPN transistors in Jedec TO-3 metal case. They are intended for power amplifier and switching circuits. The complementary PNP types are the 2N4398/99 and 2N5745 respectively.

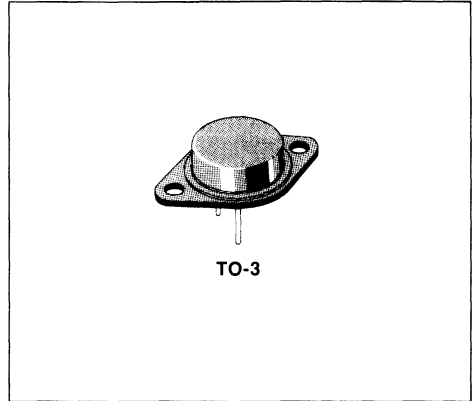

INTERNAL SCHEMATIC DIAGRAMS

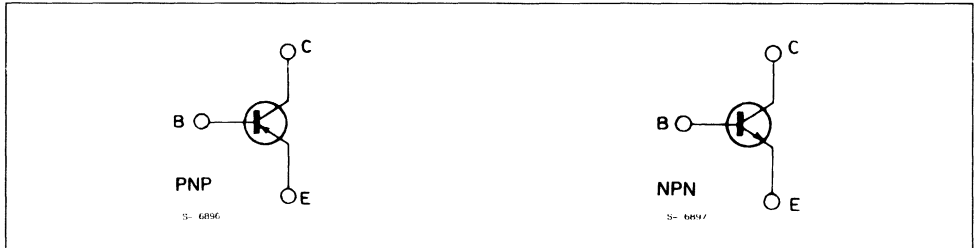

ABSOLUTE MAXIMUM RATINGS

Symbol	Parameter	PNP	2N5301	2N5302	2N5303	Unit
		NPN	2N4398	2N4399	2N5745	
V_{CE0}	Collector-emitter Voltage ($I_B = 0$)		40	60	80	V
V_{CBO}	Collector-base Voltage ($I_E = 0$)		40	60	80	V
V_{EBO}	Emitter-base Voltage ($I_C = 0$)		5	5	5	V
I_C	Collector Current		30	30	20	A
I_{CM}	Collector Peak Current		50			A
I_B	Base Current		7.5			A
P_{tot}	Total Power Dissipation at $T_{case} \leq 25^\circ C$		200			W
T_{stg}	Storage Temperature		- 65 to 200			$^\circ C$
T_J	Junction Temperature		200			$^\circ C$

For PNP types voltage and current values are negative.

THERMAL DATA

$R_{th\ j-case}$	Thermal Resistance Junction-case	Max	0.875	°C/W
------------------	----------------------------------	-----	-------	------

ELECTRICAL CHARACTERISTICS ($T_{case} = 25\text{ °C}$ unless otherwise specified)

Symbol	Parameter	Test Conditions	Min.	Typ.	Max.	Unit
I_{EBO}	Emitter Cutoff Current ($I_C = 0$)	$V_{EB} = 5\text{ V}$			5	mA
I_{CBO}	Collector Current ($I_E = 0$)	$V_{CB} = \text{rated } V_{CBO}$			1	mA
I_{CEV}	Collector Cutoff Current ($V_{BE} = -1.5\text{ V}$)	$V_{CE} = \text{rated } V_{CEO}$ for 2N4398/99, 2N5745 for 2N5301/2/3 $V_{CE} = 30\text{ V}$ $T_{case} = 150\text{ °C}$ for 2N4398/99 $V_{CE} = 80\text{ V}$ $T_{case} = 150\text{ °C}$ for 2N5745 $V_{CE} = \text{rated } V_{CEO}$ $T_{case} = 150\text{ °C}$ for 2N5301/2/3			5 1 10 10	mA mA mA mA
I_{CEO}	Collector Cutoff Current ($I_B = 0$)	$V_{CE} = \text{rated } V_{CEO}$			5	mA
$V_{CEO(sus)*}$	Collector-emitter Sustaining Voltage ($I_B = 0$)	$I_C = 200\text{ mA}$ for 2N4398, 2N5301 for 2N4399, 2N5302 for 2N5745, 2N5303	40 60 80			V V V
h_{FE*}	DC Current Gain	$I_C = 1\text{ A}$ $V_{CE} = 2\text{ V}$ for 2N5745, 2N5303 $I_C = 10\text{ A}$ $V_{CE} = 2\text{ V}$ $I_C = 20\text{ A}$ $V_{CE} = 2\text{ V}$ for 2N4398/99, 2N5301/2 $I_C = 15\text{ A}$ $V_{CE} = 2\text{ V}$ $I_C = 30\text{ A}$ $V_{CE} = 4\text{ V}$	40 15 5 15 5		60 60	
$V_{CE(sat)*}$	Collector-emitter Saturation Voltage	$I_C = 10\text{ A}$ $I_B = 1\text{ A}$ for 2N4398/99, 2N5301/2 for 2N5745, 2N5303 $I_C = 15\text{ A}$ $I_B = 1.5\text{ A}$ for 2N4398/99, 2N5301/2 for 2N5745, 2N5303 $I_C = 20\text{ A}$ $I_B = 2\text{ A}$ for 2N4398/99, 2N5301/2 $I_C = 20\text{ A}$ $I_B = 4\text{ A}$ for 2N5745, 2N5303 $I_C = 30\text{ A}$ $I_B = 6\text{ A}$ for 2N4398/99, 2N5301/2			0.75 1 1 1.5 2 2 4	V V V V V V V
$V_{BE(sat)*}$	Base-emitter Saturation Voltage	$I_C = 10\text{ A}$ $I_B = 1\text{ A}$ $I_C = 15\text{ A}$ $I_B = 1.5\text{ A}$ for 2N4398/99, 2N5301/2 for 2N5745, 2N5303 $I_C = 20\text{ A}$ $I_B = 2\text{ A}$ for 2N4398/99, 2N5301/2 $I_C = 20\text{ A}$ $I_C = 4\text{ A}$ for 2N5745, 2N5303			1.7 1.8 2 2.5 2.5	V V V V V

ELECTRICAL CHARACTERISTICS (continued)

Symbol	Parameter	Test Conditions	Min.	Typ.	Max.	Unit
V_{BE}^*	Base-emitter Voltage	$I_C = 10\text{ A}$ $V_{CE} = 2\text{ V}$ for 2N5745, 2N5303 $I_C = 15\text{ A}$ $V_{CE} = 2\text{ V}$ for 2N4398/99, 2N5301/2 $I_C = 20\text{ A}$ $V_{CE} = 4\text{ V}$ for 2N5745, 2N5303 $I_C = 30\text{ A}$ $V_{CE} = 4\text{ V}$ for 2N4398/99, 2N5301/3			1.5 1.7 2.5 3	V V V V
f_T	Transition Frequency	$I_C = 1\text{ A}$ $V_{CE} = 10\text{ V}$ $f = 1\text{ MHz}$ for 2N4398/99, 2N5301/2 for 2N5745, 2N5303	4 2			MHz MHz
h_{fe}	Small Signal Current Gain	$I_C = 1\text{ A}$ $V_{CE} = 10\text{ A}$ $f = 1\text{ KHz}$	40			
t_r	Rise Time				1	μs
t_s	Storage Time	$V_{CC} = 30\text{ V}$ $I_C = 10\text{ A}$ $I_{B1} = -I_{B2} = 1\text{ A}$			2	μs
t_f	Fall Time				1	μs

* Pulsed : pulse duration = 300 μs , duty cycle \leq 2%.
For PNP types voltage and current values are negative.

Safe Operating Areas.

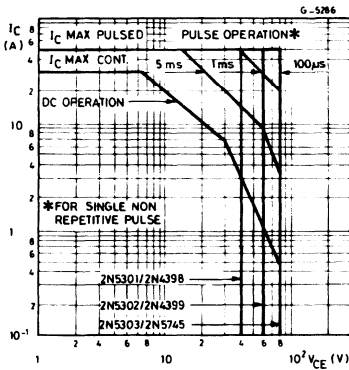

DC Current Gain (NPN types).

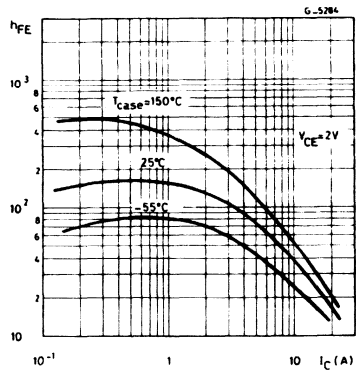

DC Current Gain (NPN types).

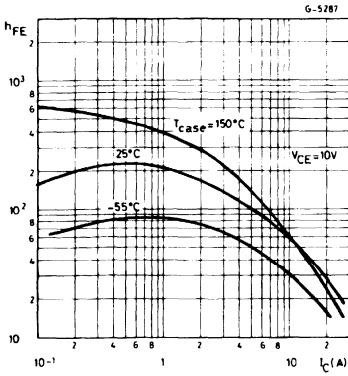

DC Current Gain (PNP types).

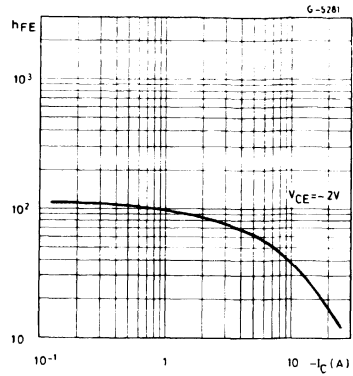

DC Current Gain (PNP types).

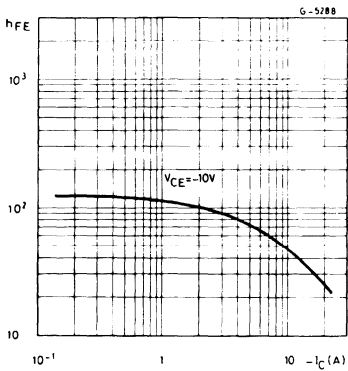

Saturation Voltage (NPN types).

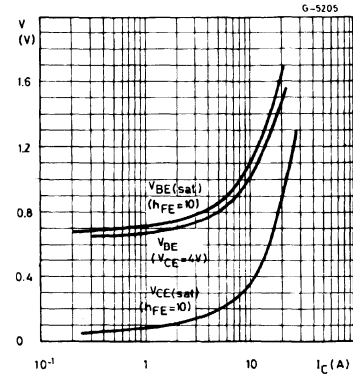

Collector-emitter Saturation Voltage (NPN types).

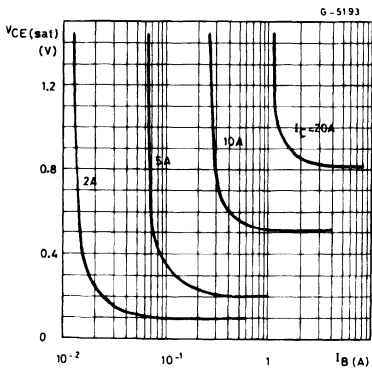

Base-emitter Voltage (PNP types).

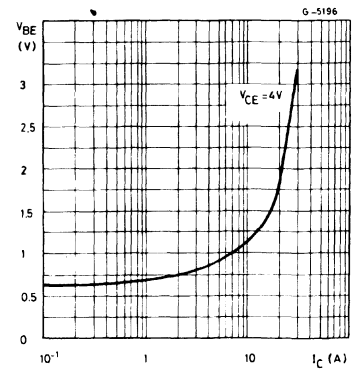

Collector-emitter Saturation Voltage (PNP types).

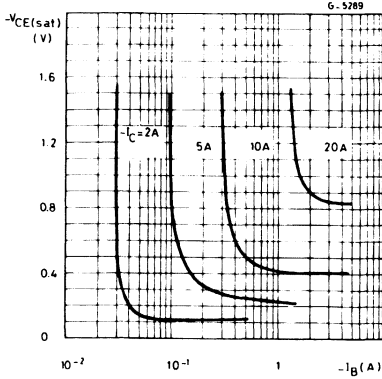

Collector-emitter Saturation Voltage (PNP types).

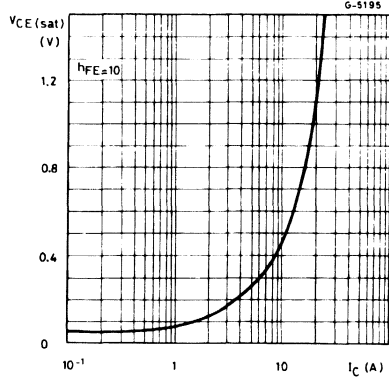

Base-emitter Saturation Voltage (PNP types).

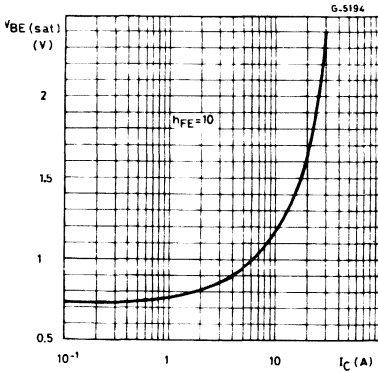

Capacitances (NPN types).

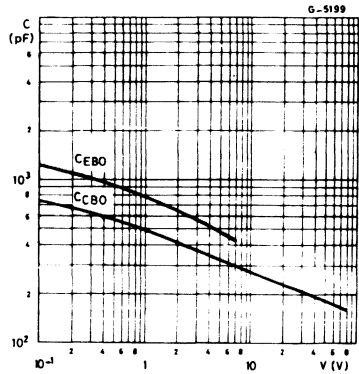

Capacitances (PNP types).

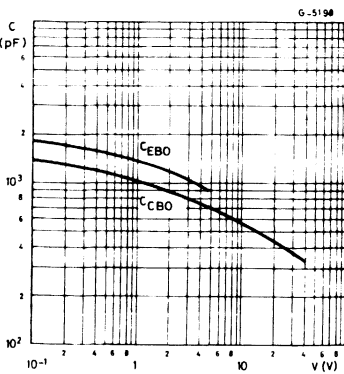

Turn-on Time (NPN types).

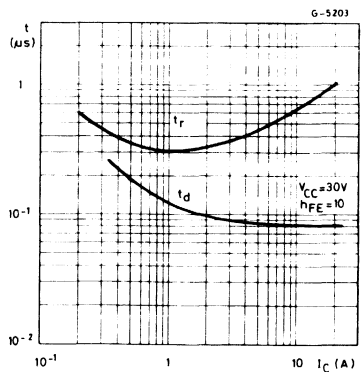

Turn-off Time (NPN types).

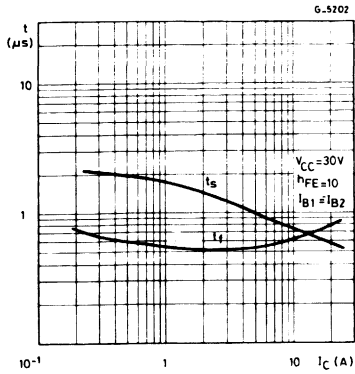

Turn-on Time (PNP types).

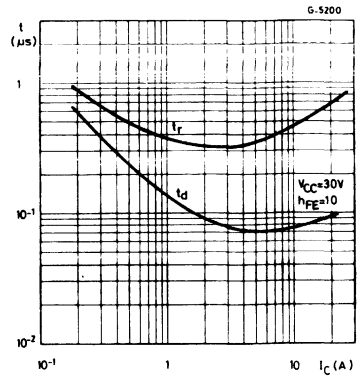

Turn-off Time (PNP types).

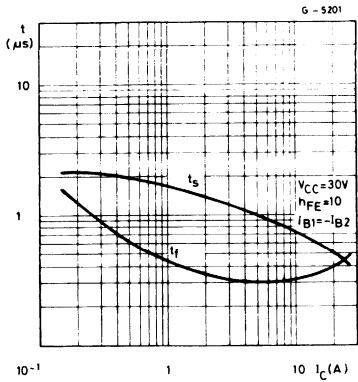

HIGH CURRENT FAST SWITCHING APPLICATION

DESCRIPTION

The 2N5336, 2N5337, 2N5338 and 2N5339 are silicon epitaxial planar NPN transistors in Jedec TO-39 metal case.

They are intended for high current switching applications up to 5A.

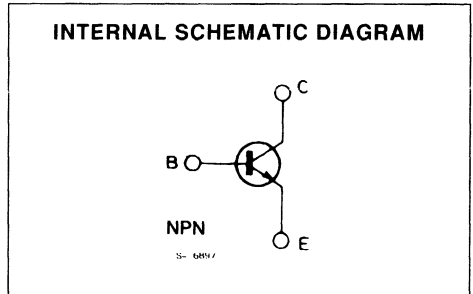
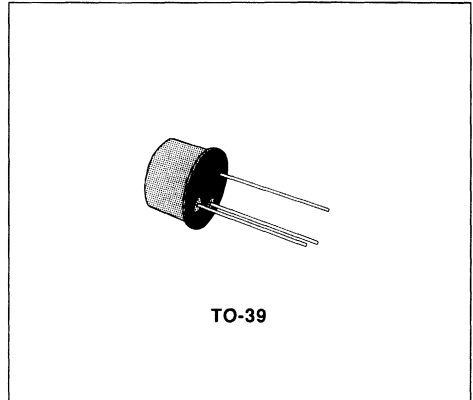

ABSOLUTE MAXIMUM RATINGS

Symbol	Parameter	2N5336 2N5337	2N5338 2N5339	Unit
V_{CBO}	Collector-base Voltage ($I_E = 0$)	80	100	V
V_{CEO}	Collector-emitter Voltage ($I_B = 0$)	80	100	V
V_{EBO}	Emitter-base Voltage ($I_C = 0$)	6		V
I_C	Collector Current	5		A
I_{CM}	Collector Peak Current	7		A
I_B	Base Current	1		A
P_{tot}	Total Power Dissipation at $T_{amb} \leq 25^\circ C$ $T_{case} \leq 25^\circ C$	1		W
		6		W
T_{stg}	Storage Temperature	- 65 to 200		$^\circ C$
T_j	Junction Temperature	200		$^\circ C$

THERMAL DATA

$R_{th\ j-case}$	Thermal Resistance Junction-case	Max	29.2	°C/W
$R_{th\ j-amb}$	Thermal Resistance Junction-ambient	Max	175	°C/W

ELECTRICAL CHARACTERISTICS ($T_{case} = 25\text{ °C}$ unless otherwise specified)

Symbol	Parameter	Test Conditions	Min.	Typ.	Max.	Unit
I_{CBO}	Collector Cutoff Current ($I_E = 0$)	for 2N5336 and 2N5337 $V_{CB} = 80\text{ V}$			10	μA
		for 2N5338 and 2N5339 $V_{CB} = 100\text{ V}$			10	μA
I_{CEO}	Collector Cutoff Current ($I_B = 0$)	for 2N5336 and 2N5337 $V_{CE} = 75\text{ V}$			100	μA
		for 2N5338 and 2N5339 $V_{CE} = 90\text{ V}$			100	μA
I_{CEX}	Collector Cutoff Current ($V_{BE} = -1.5\text{ V}$)	for 2N5336 and 2N5337 $V_{CE} = 75\text{ V}$			10	μA
		$V_{CE} = 75\text{ V}$ $T_{case} = 150\text{ °C}$			1	mA
		for 2N5338 and 2N5339 $V_{CE} = 90\text{ V}$			10	μA
		$V_{CE} = 90\text{ V}$ $T_{case} = 150\text{ °C}$			1	mA
$V_{CEO(sus)}^*$	Collector-emitter Sustaining Voltage ($I_B = 0$)	$I_C = 50\text{ mA}$ for 2N5336 and 2N5337 for 2N5338 and 2N5339	80 100			V V
$V_{CE(sat)}^*$	Collector-emitter Saturation Voltage	$I_C = 2\text{ A}$ $I_B = 0.2\text{ A}$			0.7	V
		$I_C = 5\text{ A}$ $I_B = 0.5\text{ A}$			1.2	V
$V_{BE(sat)}^*$	Base-emitter Saturation Voltage	$I_C = 2\text{ A}$ $I_B = 0.2\text{ A}$			1.2	V
		$I_C = 5\text{ A}$ $I_B = 0.5\text{ A}$			1.8	V
h_{FE}^*	DC Current Gain	$I_C = 0.5\text{ A}$ $V_{CE} = 2\text{ V}$ for 2N5336 and 2N5337	30			
		for 2N5338 and 2N5339	60			
		$I_C = 2\text{ A}$ $V_{CE} = 2\text{ V}$ for 2N5336 and 2N5337	30		120	
		for 2N5338 and 2N5339	60		240	
		$I_C = 5\text{ A}$ $V_{CE} = 2\text{ V}$ for 2N5336 and 2N5337	20			
		for 2N5338 and 2N5339	40			
f_T	Transition Frequency	$I_C = 0.5\text{ A}$ $V_{CE} = 10\text{ V}$	30			MHz
C_{CBO}	Collector-base Capacitance	$V_{CB} = 10\text{ V}$ $I_E = 0$ $f = 0.1\text{ MHz}$			250	μF
t_{on}	Turn-on Time	$I_C = 2\text{ A}$ $V_{CC} = 40\text{ V}$ $I_{B1} = 0.2\text{ A}$			200	ns
t_s	Storage Time	$I_C = 2\text{ A}$ $V_{CC} = 40\text{ V}$ $I_{B1} = -I_{B2} = 0.2\text{ A}$			2	μs
t_f	Fall Time				200	ns

* Pulsed : pulse duration = 300 μs , duty cycle = 1.5%.

Safe Operating Areas.

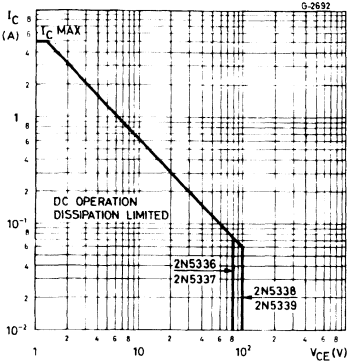

DC Current Gain.

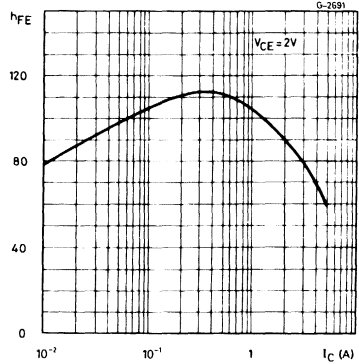

Collector-emitter Saturation Voltage.

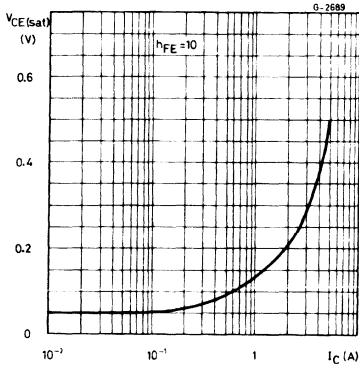

Base-emitter Saturation Voltage.

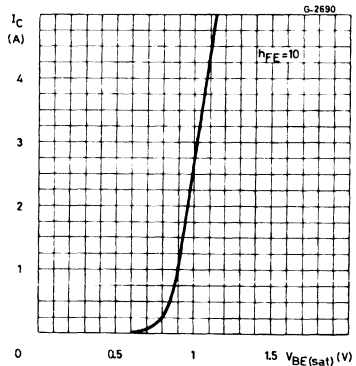

Collector-base Capacitance.

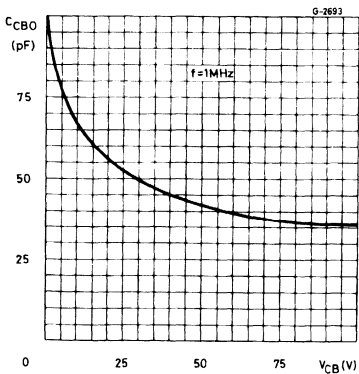

Saturated Switching Characteristics.

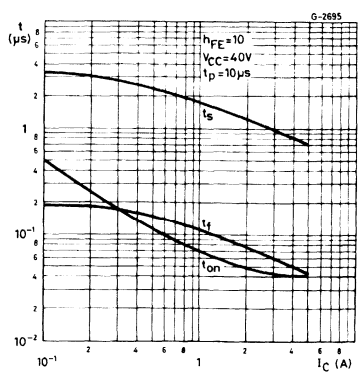

Power Rating Chart.

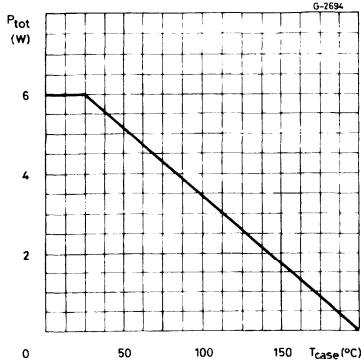

Switching Time Test Circuit.

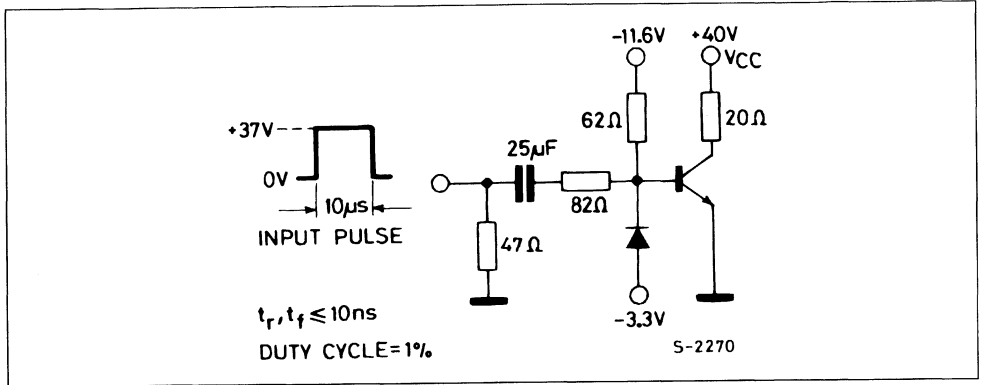

HIGH VOLTAGE TRANSISTORS

DESCRIPTION

The 2N5415, 2N5416 are high voltage silicon epitaxial planar transistors designed for use in consumer and industrial line-operated applications. These devices are particularly suited as drivers in high-voltage low current inverters, switching and series regulators.

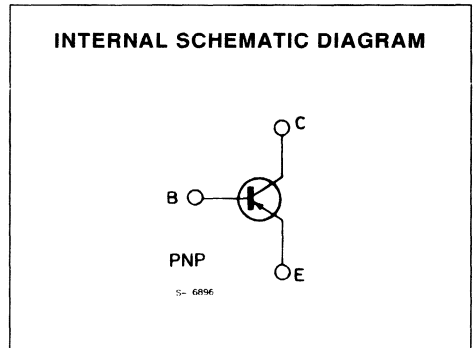
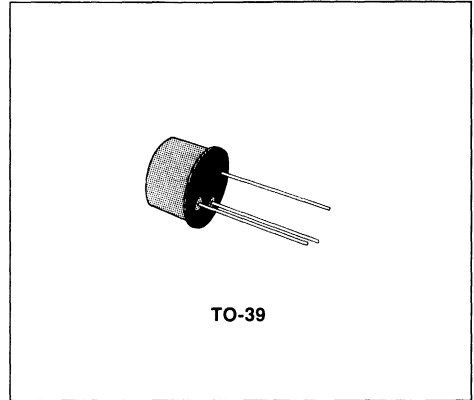

ABSOLUTE MAXIMUM RATINGS

Symbol	Parameter	2N5415	2N5416	Unit
V_{CBO}	Collector-base Voltage ($I_E = 0$)	- 200	- 350	V
V_{CEO}	Collector-emitter Voltage ($I_B = 0$)	- 200	- 300	V
V_{EBO}	Emitter-base Voltage ($I_C = 0$)	- 4	- 6	V
I_C	Collector Current	- 1		A
I_B	Base Current	- 0.5		A
P_{tot}	Total Power Dissipation at $T_{case} \leq 25^\circ C$ $T_{amb} \leq 50^\circ C$	10	1	W
T_{stg}	Storage Temperature	- 65 to 200		$^\circ C$
T_J	Junction Temperature	200		$^\circ C$

THERMAL DATA

$R_{th\ j-case}$	Thermal Resistance Junction-case	Max	17.5	°C/W
$R_{th\ j-amb}$	Thermal Resistance Junction-ambient	Max	150	°C/W

ELECTRICAL CHARACTERISTICS ($T_{case} = 25\ ^\circ C$ unless otherwise specified)

Symbol	Parameter	Test Conditions	Min.	Typ.	Max.	Unit
I_{CBO}	Collector Cutoff Current ($I_E = 0$)	for 2N5415 $V_{CB} = -175\ V$ for 2N5416 $V_{CB} = -280\ V$			-50 -50	μA μA
I_{CEO}	Collector Cutoff Current ($I_B = 0$)	$V_{CE} = -150\ V$			-50	μA
I_{EBO}	Emitter Cutoff Current ($I_C = 0$)	for 2N5415 $V_{EB} = -4\ V$ for 2N5416 $V_{EB} = -6\ V$			-20 -20	μA μA
$V_{CEO(sus)}^*$	Collector-emitter Sustaining Voltage ($I_B = 0$)	$I_C = -10\ mA$ for 2N5415 for 2N5416	-200 -300			V V
V_{CER}^*	Collector-emitter Sustaining Voltage ($R_{BE} = 50\ \Omega$)	$I_C = -50\ mA$ for 2N5416	-350			V
$V_{CE(sat)}^*$	Collector-emitter Saturation Voltage	$I_C = -50\ mA$ $I_B = -5\ mA$			-2.5	V
V_{BE}^*	Base-emitter Voltage	$I_C = -50\ mA$ $V_{CE} = -10\ V$			-1.5	V
h_{FE}^*	DC Current Gain	$I_C = -50\ mA$ $V_{CE} = -10\ V$ for 2N5415 for 2N5416	30 30		150 120	
h_{fe}	Small Signal Current Gain	$I_C = -5\ mA$ $f = 1\ KHz$ $V_{CE} = -10\ V$	25			
f_T	Transition Frequency	$I_C = -10\ mA$ $f = 5\ MHz$ $V_{CE} = -10\ V$	15			MHz
C_{CBO}	Collector-base Capacitance	$I_E = 0$ $f = 1\ MHz$ $V_{CB} = -10\ V$			25	pF

* Pulsed : pulse duration = 300 μs , duty cycle $\leq 2\%$.

Safe Operating Areas.

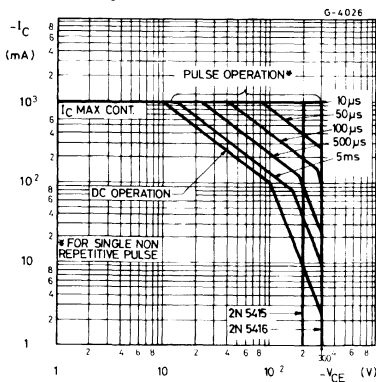

DC Current Gain.

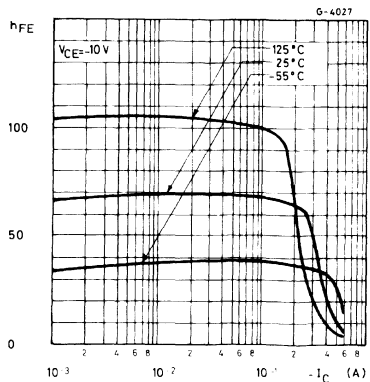

Collector-emitter Saturation Voltage.

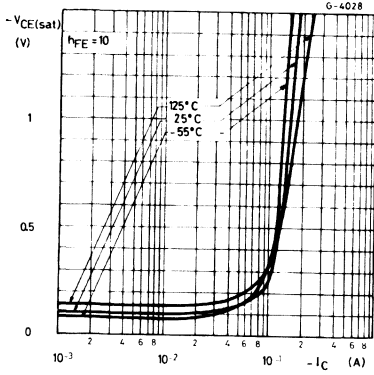

Base-emitter Voltage.

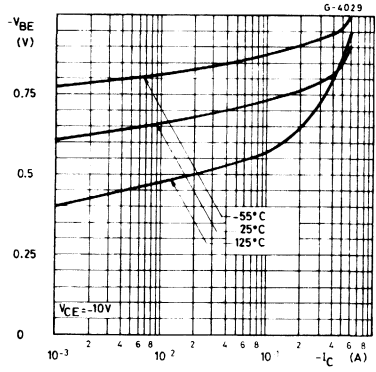

Transition Frequency.

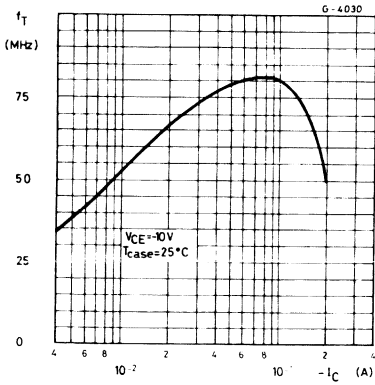

Switching Times.

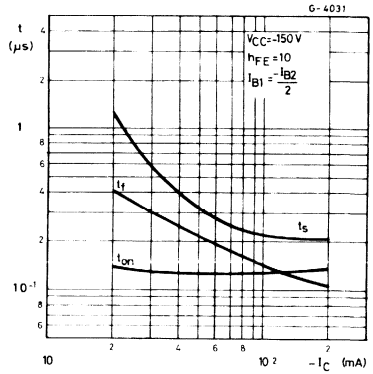

COMPLEMENTARY HIGH POWER TRANSISTORS

DESCRIPTION

The 2N5629 (NPN) and 2N6029 (PNP) are complementary silicon epitaxial-base transistors in Jedec TO-3 metal case. They are intended for high power audio amplifier applications and switching regular circuits.

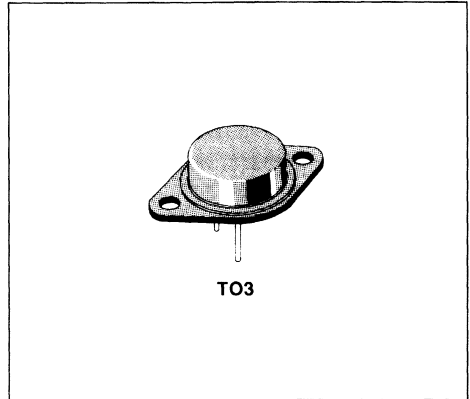

INTERNAL SCHEMATIC DIAGRAMS

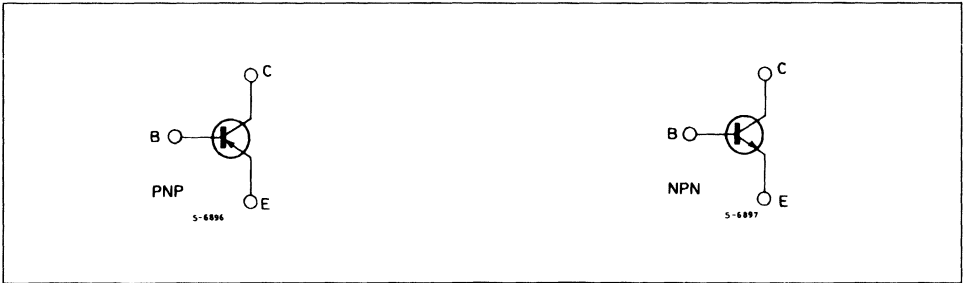

ABSOLUTE MAXIMUM RATINGS

Symbol	Parameter	Value	Unit
V_{CEO}	Collector-emitter Voltage ($I_B = 0$)	100	V
V_{CBO}	Collector-base Voltage ($I_E = 0$)	100	V
V_{EBO}	Emitter-base Voltage ($I_C = 0$)	7	V
I_C	Collector Current	16	A
I_{CM}	Collector Peak Current	20	A
I_B	Base Current	5	A
P_{tot}	Total Power Dissipation at $T_{case} \leq 25^\circ\text{C}$	200	W
T_{stg}	Storage Temperature	- 65 to 200	$^\circ\text{C}$
T_J	Junction Temperature	200	$^\circ\text{C}$

For PNP type voltage and current values are negative.

THERMAL DATA

$R_{th\ j-case}$	Thermal Resistance Junction-case	Max	0.875	°C/W
------------------	----------------------------------	-----	-------	------

ELECTRICAL CHARACTERISTICS ($T_{case} = 25^{\circ}C$ unless otherwise specified)

Symbol	Parameter	Test Conditions	Min.	Typ.	Max.	Unit
I_{CEO}	Collector Cutoff Current ($I_B = 0$)	$V_{CE} = 50V$			1	mA
I_{EBO}	Emitter Cutoff Current ($I_C = 0$)	$V_{EB} = 7V$			1	mA
I_{CBO}	Collector Cutoff Current ($I_E = 0$)	$V_{CB} = 100V$			1	mA
I_{CEV}	Collector-emitter Cutoff Current ($V_{BE} = -1.5V$)	$V_{CE} = 100V$ $V_{CE} = 100V$			1 5	mA mA
$V_{CEO(sus)}^*$	Collector-emitter Sustaining Voltage ($I_B = 0$)	$I_C = 200mA$	100			V
h_{FE}^*	DC Current Gain	$I_C = 8A$ $I_C = 16A$	$V_{CE} = 2V$ $V_{CE} = 2V$	25 4	100	
$V_{CE(sat)}^*$	Collector-emitter Saturation Voltage	$I_C = 10A$ $I_C = 16A$	$I_B = 1A$ $I_B = 4A$		1 2	V V
$V_{BE(sat)}^*$	Base-emitter Saturation Voltage	$I_C = 10A$	$I_B = 1A$		1.8	V
V_{BE}^*	Base-emitter Voltage	$I_C = 8A$	$V_{CE} = 2V$		1.5	V
f_T	Transition Frequency	$I_C = 1A$ $f = 0.5MHz$	$V_{CE} = 20V$	1		MHz
C_{CBO}	Collector-base Capacitance	$V_{CB} = 10V$ $f = 0.1MHz$ for 2N6029	$I_E = 0$		500 1000	pF pF
h_{fe}	Small Signal Current Gain	$I_C = 4A$ $f = 1KHz$	$V_{CE} = 10V$	15		

* Pulsed : pulse duration = 300 μs , duty cycle $\leq 2\%$.
For PNP type voltage and current values are negative.

Safe Operating Areas.

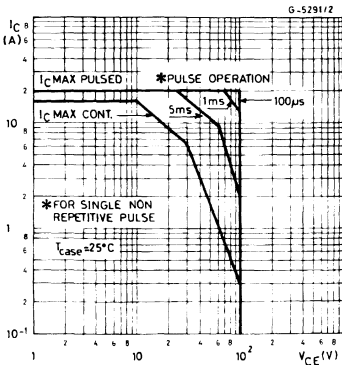

DC Current Gain (NPN type).

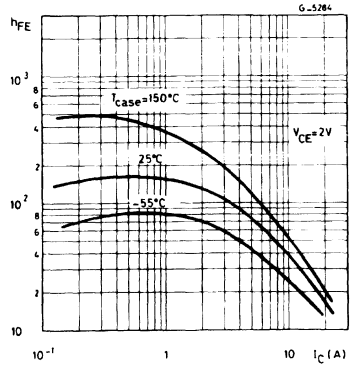

DC Current Gain (NPN type).

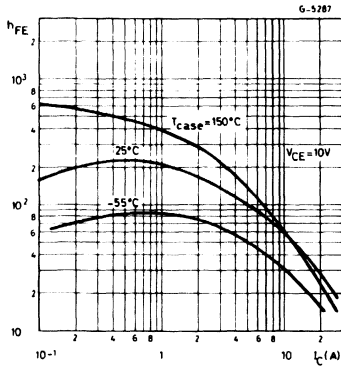

DC Current Gain (PNP type).

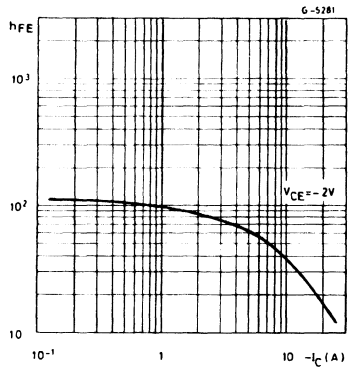

DC Current Gain (PNP type).

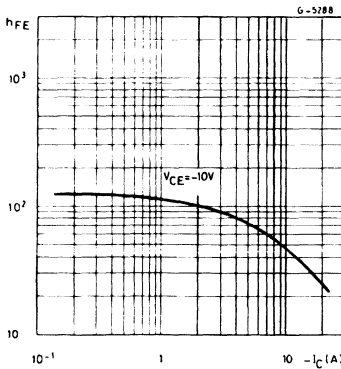

Collector-emitter Saturation Voltage (PNP type).

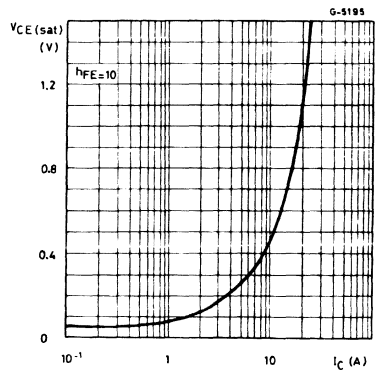

Collector-emitter Saturation Voltage (NPN type).

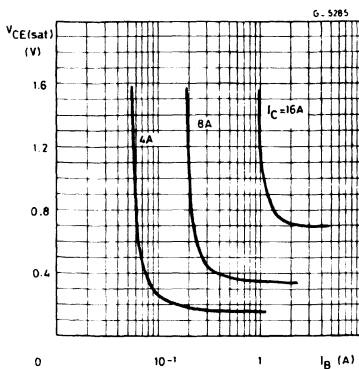

Collector-emitter Saturation Voltage (PNP type).

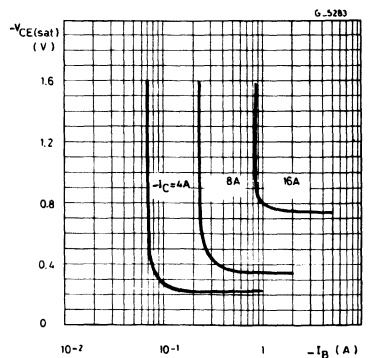

Saturation Voltage (PNP type).

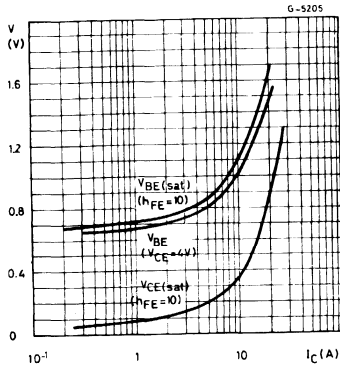

Base-emitter Voltage (PNP type).

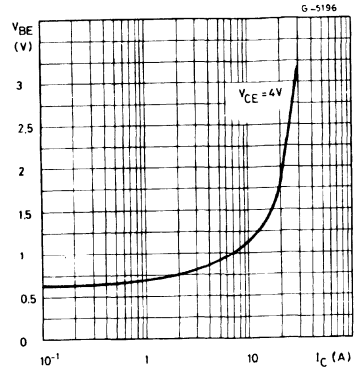

Base-emitter Saturation Voltage (PNP type).

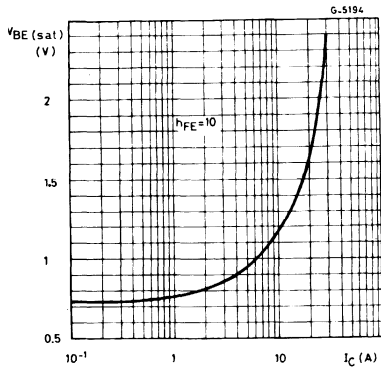

Capacitances (NPN type).

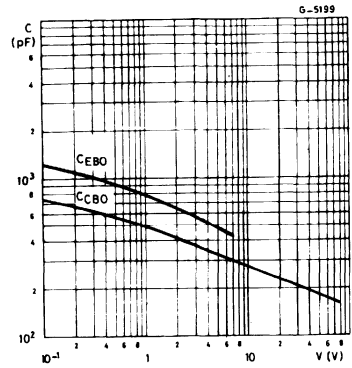

Capacitances (PNP type).

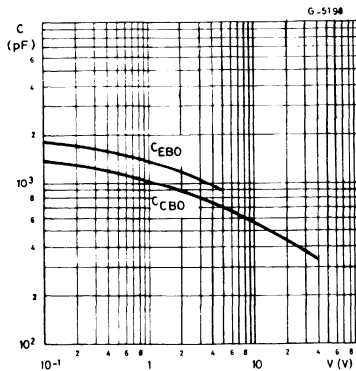

Turn-on Time (NPN type).

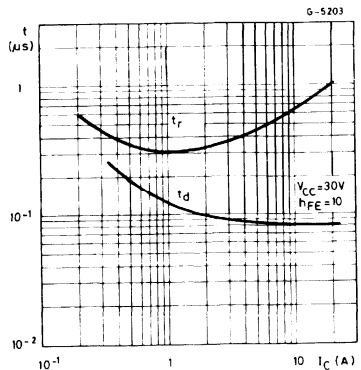

Turn-off Time (NPN type).

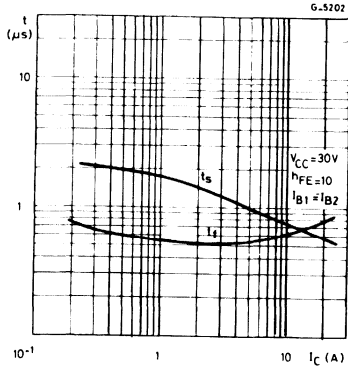

Turn-on Time (PNP type).

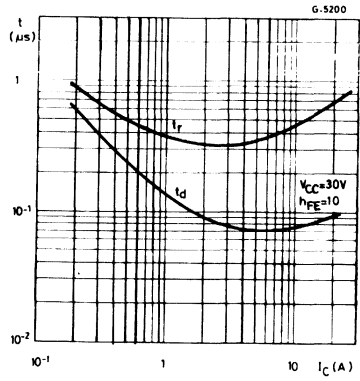

Turn-off Time (PNP type).

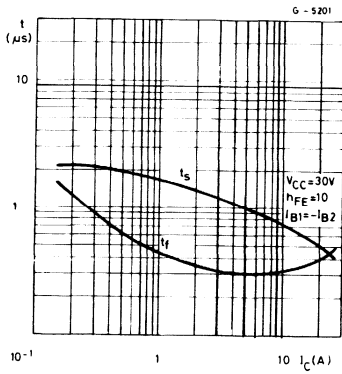

HIGH VOLTAGE POWER TRANSISTORS

DESCRIPTION

The 2N5655, 2N5656 and 2N5657 are silicon epitaxial planar NPN transistors in Jedec TO-126 plastic package. They are intended for use audio output amplifiers, low current, high voltage converters and AC line relays.

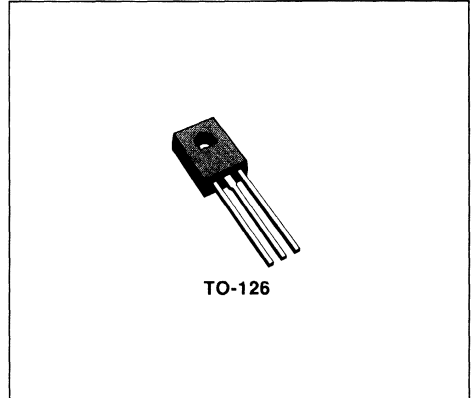

INTERNAL SCHEMATIC DIAGRAM

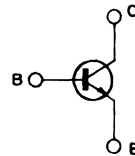

ABSOLUTE MAXIMUM RATINGS

Symbol	Parameter	2N5655	2N5656	2N5657	Unit
V_{CBO}	Collector-base Voltage ($I_E = 0$)	275	325	375	V
V_{CEO}	Collector-emitter Voltage ($I_B = 0$)	250	300	350	V
V_{EBO}	Emitter-base Voltage ($I_C = 0$)	6			V
I_C	Collector Current	0.5			A
I_{CM}	Collector Peak Current	1			A
I_B	Base Current	0.25			A
P_{tot}	Total Power Dissipation at $T_{case} \leq 25^\circ\text{C}$	20			W
T_{stg}	Storage Temperature	- 65 to 150			$^\circ\text{C}$
T_j	Junction Temperature	150			$^\circ\text{C}$

THERMAL DATA

$R_{th\ j-case}$	Thermal Resistance Junction-case	Max	6.25	°C/W
------------------	----------------------------------	-----	------	------

ELECTRICAL CHARACTERISTICS ($T_{case} = 25^{\circ}C$ unless otherwise specified)

Symbol	Parameter	Test Conditions	Min.	Typ.	Max.	Unit
I_{CBO}	Collector Cutoff Current ($I_E = 0$)	$V_{CB} = \text{rated } V_{CBO}$			10	μA
I_{CEV}	Collector Cutoff Current ($V_{BE} = -1.5V$)	$V_{CE} = \text{rated } V_{CEO}$ $T_{case} = 100^{\circ}C$ for 2N5655 $V_{CE} = 150V$ for 2N5656 $V_{CE} = 200V$ for 2N5657 $V_{CE} = 250V$			0.1 1 1 1	mA mA mA mA
I_{CEO}	Collector Cutoff Current ($I_B = 0$)	for 2N5655 $V_{CE} = 150V$ for 2N5656 $V_{CE} = 200V$ for 2N5657 $V_{CE} = 250V$			0.1 0.1 0.1	mA mA mA
I_{EBO}	Emitter-base Current ($I_C = 0$)	$V_{EB} = 6V$			10	μA
$V_{(BR)CEO}^*$	Collector-emitter Breakdown Voltage ($I_B = 0$)	$I_C = 1mA$ for 2N5655 for 2N5656 for 2N5657	250 300 350			V V V
$V_{CEO(sus)}^*$	Collector-emitter Sustaining Voltage	$I_C = 100mA$ for 2N5655 $L = 50mH$ for 2N5656 for 2N5657	250 300 350			V V V
$V_{CE(sat)}^*$	Collector-emitter Saturation Voltage	$I_C = 0.1A$ $I_B = 10mA$ $I_C = 0.25A$ $I_B = 25mA$ $I_C = 0.5A$ $I_B = 0.1A$			1 2.5 10	V V V
V_{BE}^*	Base-emitter Voltage	$I_C = 0.1V$ $V_{CE} = 10V$			1	V
h_{FE}^*	DC Current Gain	$I_C = 50mA$ $V_{CE} = 10V$ $I_C = 0.1A$ $V_{CE} = 10V$ $I_C = 0.25A$ $V_{CE} = 10V$ $I_C = 0.5A$ $V_{CE} = 10V$	25 30 15 5		250	
h_{fe}	Small Signal Current Gain	$I_C = 0.1A$ $V_{CE} = 10V$ $f = 1KHz$	20			
f_T	Transition Frequency	$I_C = 50mA$ $V_{CE} = 10V$ $f = 10MHz$	10			MHz
C_{CBO}	Collector-base Capacitance	$V_{CB} = 10V$ $f = 100KHz$			25	pF

* Pulsed : pulse duration = 300 μs , duty cycle $\leq 1.5\%$.

Safe Operating Areas.

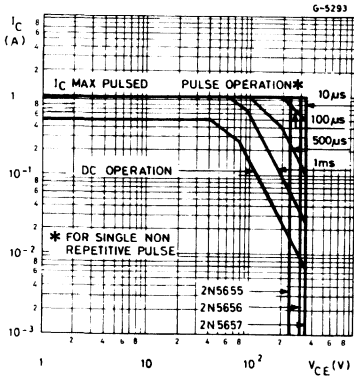

DC Current Gain.

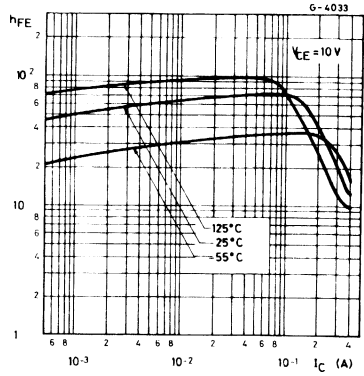

Collector-emitter Saturation Voltage.

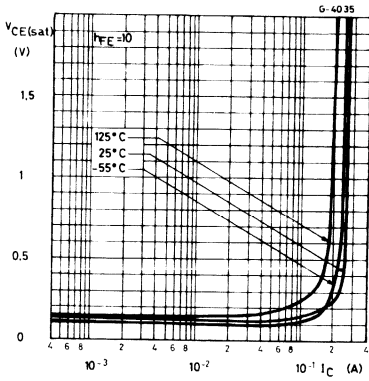

HIGH CURRENT FAST SWITCHING APPLICATIONS

DESCRIPTION

The 2N5671 and 2N5672 are silicon multi-epitaxial planar NPN transistors in Jedec TO-3 metal case.

They are especially intended for high current, fast switching industrial applications.

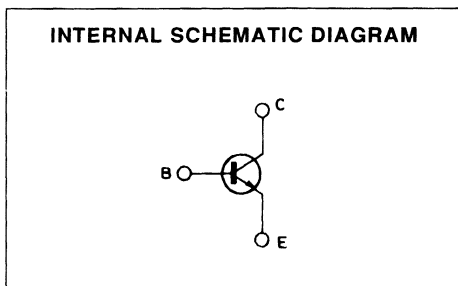
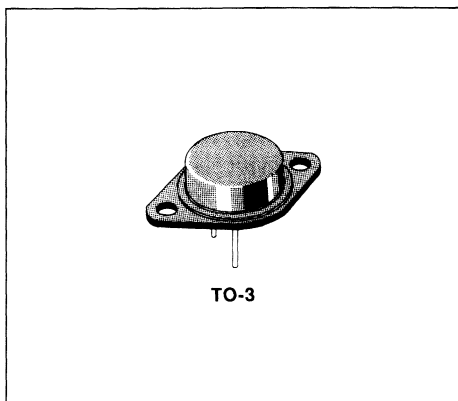

ABSOLUTE MAXIMUM RATINGS

Symbol	Parameter	2N5671	2N5672	Unit
V_{CRO}	Collector-base Voltage ($I_E = 0$)	120	150	V
V_{CEX}	Collector-emitter Voltage ($V_{BE} = -1.5V$, $R_{BE} = 50\Omega$)	120	150	V
V_{CER}	Collector-emitter Voltage ($R_{BE} \leq 50\Omega$)	110	140	V
V_{CEO}	Collector-emitter Voltage ($I_B = 0$)	90	120	V
V_{EBO}	Emitter-base Voltage ($I_C = 0$)	7		V
I_C	Collector Current	30		A
I_B	Base Current	10		A
P_{tot}	Total Power Dissipation at $T_{case} \leq 25^\circ C$	140		W
T_{stg}	Storage Temperature	- 65 to 200		$^\circ C$
T_j	Junction Temperature	200		$^\circ C$

THERMAL DATA

$R_{th\ j-case}$	Thermal Resistance Junction-case	Max	1.25	°C/W
------------------	----------------------------------	-----	------	------

ELECTRICAL CHARACTERISTICS ($T_{case} = 25^{\circ}C$ unless otherwise specified)

Symbol	Parameter	Test Conditions	Min.	Typ.	Max.	Unit
I_{CEV}	Collector Cutoff Current ($V_{BE} = -1.5V$)	for 2N5671 $V_{CE} = 110V$			12	mA
		for 2N5672 $V_{CE} = 135V$			10	mA
		$V_{CE} = 100V$ $T_{case} = 150^{\circ}C$ for 2N5671 for 2N5672			15	mA
					10	mA
I_{CEO}	Collector Cutoff Current ($I_B = 0$)	$V_{CE} = 80V$			10	mA
I_{EBO}	Emitter Cutoff Current ($I_C = 0$)	$V_{EB} = 7V$			10	mA
$V_{CEX(sus)*}$	Collector-emitter Sustaining Voltage ($V_{BE} = -1.5V$ $R_{BE} = 50\Omega$)	$I_C = 200mA$	for 2N5671	120		V
			for 2N5672	150		V
$V_{CER(sus)*}$	Collector-emitter Sustaining Voltage ($R_{BE} = 50\Omega$)	$I_C = 200mA$	for 2N5671	110		V
			for 2N5672	140		V
$V_{CEO(sus)*}$	Collector-emitter Sustaining Voltage ($I_B = 0$)	$I_C = 200mA$	for 2N5671	90		V
			for 2N5672	120		V
$V_{CE(sat)*}$	Collector-emitter Saturation Voltage	$I_C = 15A$	$I_B = 1.2A$		0.75	V
$V_{BE(sat)*}$	Base-emitter Saturation Voltage	$I_C = 15A$	$I_B = 1.2A$		1.5	V
V_{BE}^*	Base-emitter Voltage	$I_C = 15A$	$V_{CE} = 5V$		1.6	V
h_{FE}^*	DC Current Gain	$I_C = 15A$ $I_C = 20A$	$V_{CE} = 2V$	20	100	
			$V_{CE} = 5V$	20		
f_T	Transistion Frequency	$I_C = 2A$	$V_{CE} = 10V$	50		MHz
C_{CBO}	Collector-base Capacitance	$I_E = 0$ $f = 1MHz$	$V_{CB} = 10V$		900	pF
t_{on}	Turn-on Time	$I_C = 15A$ $I_{B1} = -I_{B2} = 1.2A$	$V_{CC} = 30A$		0.5	μs
t_s	Storage Time				1.5	μs
t_f	Fall Time				0.5	μs
$I_{s/b}^{**}$	Second Breakdown Collector Current	$V_{CE} = 24V$		5.8		A
		$V_{CE} = 45V$		0.9		A
$E_{s/b}$	Second Breakdown Energy	$V_{BE} = -4V$ $L = 180\mu H$	$R_{BE} = 20\Omega$	20		mJ

* Pulsed : pulse duration = 300 μs , duty cycle = 1.5 %.

** Pulsed : 1 s, non repetitive pulse.

Safe Operating Areas.

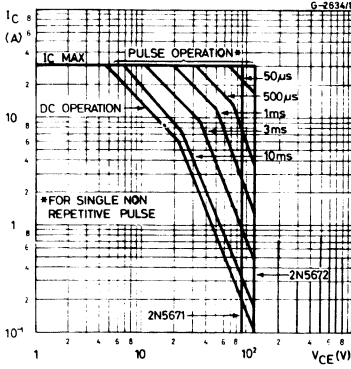

DC Transconductance.

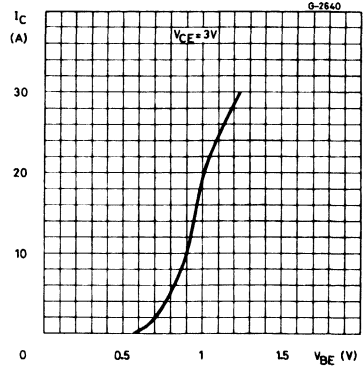

DC Current Gain.

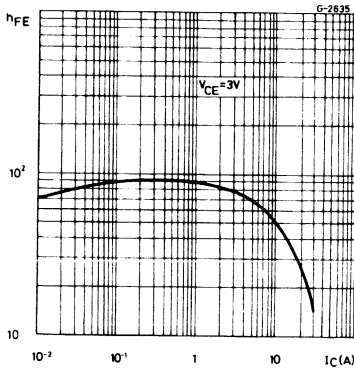

Collector-emitter Saturation Voltage.

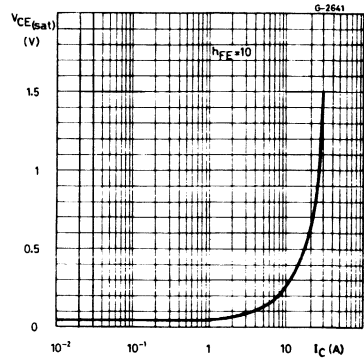

Base-emitter Saturation Voltage.

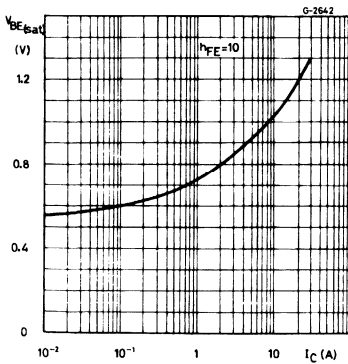

Saturated Switching Characteristics.

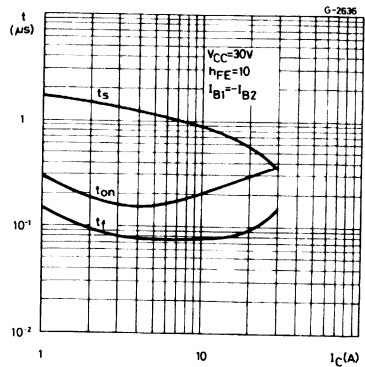

PNP SILICON TRANSISTORS

DESCRIPTION

The 2N5679 and 2N5680 are silicon epitaxial planar PNP transistors in Jedec TO-39 metal case intended for use as drivers for high power transistors in general purpose, amplifier and switching circuit.

The complementary NPN types are the 2N5681 and 2N5682 respectively.

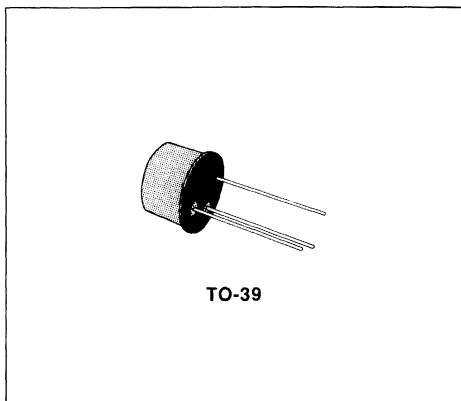

INTERNAL SCHEMATIC DIAGRAM

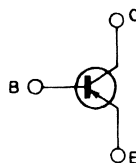

ABSOLUTE MAXIMUM RATINGS

Symbol	Parameter	2N5679	2N5680	Unit
V_{CBO}	Collector-base Voltage ($I_E = 0$)	- 100	- 120	V
V_{CEO}	Collector-emitter Voltage ($I_B = 0$)	- 100	- 120	V
V_{EBO}	Emitter-base Voltage ($I_C = 0$)	- 4		V
I_C	Collector Current	- 1		A
I_B	Base Current	- 0.5		A
P_{tot}	Total Power Dissipation at $T_{case} \leq 25^\circ\text{C}$ $T_{amb} \leq 25^\circ\text{C}$	10		W
		1		W
T_{stg}	Storage Temperature	- 65 to 200		$^\circ\text{C}$
T_j	Junction Temperature	200		$^\circ\text{C}$

THERMAL DATA

$R_{th\ j-case}$	Thermal Resistance Junction-case	Max	17.5	°C/W
$R_{th\ j-amb}$	Thermal Resistance Junction-ambient	Max	175	°C/W

ELECTRICAL CHARACTERISTICS ($T_{case} = 25^{\circ}C$ unless otherwise specified)

Symbol	Parameter	Test Conditions	Min.	Typ.	Max.	Unit
I_{CBO}	Collector Cutoff Current ($I_E = 0$)	for 2N5679 $V_{CB} = -100V$ for 2N5680 $V_{CB} = -120V$			-1 -1	μA μA
I_{CEV}	Collector Cutoff Current ($V_{BE} = 1.5$)	for 2N5679 $V_{CE} = -100V$ for 2N5680 $V_{CE} = -120V$ $T_{case} = 150^{\circ}C$ for 2N5679 $V_{CE} = -100V$ for 2N5680 $V_{CE} = -120V$			-1 -1 -1 -1	μA μA mA mA
I_{CEO}	Collector Cutoff Current ($I_B = 0$)	for 2N5679 $V_{CE} = -70V$ for 2N5680 $V_{CE} = -80V$			-10 -10	μA μA
I_{EBO}	Emitter Cutoff Current ($I_C = 0$)	$V_{EB} = -4V$			-1	μA
$V_{CEO(sus)}^*$	Collector-emitter Sustaining Voltage ($I_B = 0$)	$I_C = -10mA$ for 2N5679 for 2N5680	-100 -120			V V
$V_{CE(sat)}^*$	Collector-emitter Saturation Voltage	$I_C = -250mA$ $I_B = -25mA$ $I_C = -500mA$ $I_B = -50mA$ $I_C = -1A$ $I_B = -200mA$			-0.6 -1 -2	V V V
V_{BE}^*	Base-emitter Voltage	$I_C = -250mA$ $V_{CE} = -2V$			-1	V
h_{FE}^*	DC Current Gain	$I_C = -250mA$ $V_{CE} = -2V$ $I_C = -1A$ $V_{CE} = -2V$	40 5		150	
f_T	Transition Frequency	$I_C = -100mA$ $V_{CE} = -10V$ $f = 10MHz$	30			MHz
C_{CBO}	Collector-base Capacitance	$I_E = 0$ $V_{CB} = -20V$ $f = 1MHz$			50	pF
h_{fe}	Small Signal Current Gain	$I_C = -0.2A$ $V_{CE} = -1.5V$ $f = 1KHz$	40			

* Pulsed : pulse duration = 300 μs , duty cycle $\leq 2\%$.

GENERAL PURPOSE TRANSISTORS

DESCRIPTION

The 2N5681 and 2N5682 are silicon epitaxial planar NPN transistors in Jedec TO-39 metal case intended for use as drivers for high power transistors in general purpose amplifier and switching circuits.

The complementary PNP types are the 2N5679 and 2N5680 respectively.

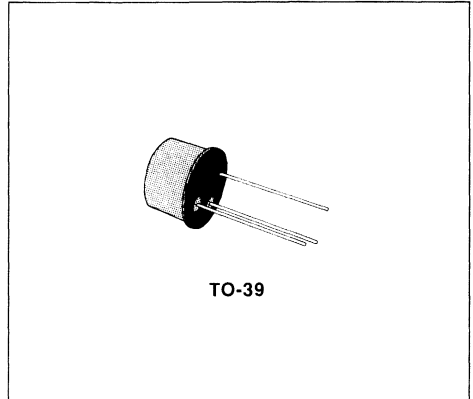

INTERNAL SCHEMATIC DIAGRAM

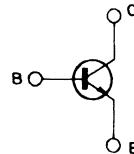

ABSOLUTE MAXIMUM RATINGS

Symbol	Parameter	2N5681	2N5682	Unit
V_{CBO}	Collector-base Voltage ($I_E = 0$)	100	120	V
V_{CEO}	Collector-emitter Voltage ($I_B = 0$)	100	120	V
V_{EBO}	Emitter-base Voltage ($I_C = 0$)	4		V
I_C	Collector Current	1		A
I_B	Base Current	0.5		A
P_{tot}	Total Power Dissipation at $T_{case} \leq 25^\circ\text{C}$ $T_{amb} \leq 25^\circ\text{C}$	10		W
		1		W
T_{stg}	Storage Temperature	- 65 to 200		$^\circ\text{C}$
T_j	Junction Temperature	200		$^\circ\text{C}$

THERMAL DATA

$R_{th\ j-case}$	Thermal Resistance Junction-case	Max	17.5	°C/W
$R_{th\ j-amb}$	Thermal Resistance Junction-ambient	Max	175	°C/W

ELECTRICAL CHARACTERISTICS($T_{case} = 25^{\circ}C$ unless otherwise specified)

Symbol	Parameter	Test Conditions	Min.	Typ.	Max.	Unit
I_{CBO}	Collector Cutoff Current ($I_E = 0$)	for 2N5681 $V_{CB} = 100V$ for 2N5682 $V_{CB} = 120V$			1	μA
I_{CEV}	Collector Cutoff Current ($V_{BE} = -1.5V$)	for 2N5681 $V_{CE} = 100V$ for 2N5682 $V_{CE} = 120V$ $T_{case} = 150^{\circ}C$ for 2N5681 $V_{CE} = 100V$ for 2N5682 $V_{CE} = 120V$			1 1 1 1	μA μA mA mA
I_{CEO}	Collector Cutoff Current ($I_B = 0$)	for 2N5681 $V_{CE} = 70V$ for 2N5682 $V_{CE} = 80V$			10 10	μA μA
I_{EBO}	Emitter Cutoff Current ($I_C = 0$)	$V_{EB} = 4V$			1	μA
$V_{CEO(sus)}^*$	Collector-emitter Sustaining Voltage ($I_B = 0$)	$I_C = 10mA$ for 2N5681 for 2N5682	100 120			V V
$V_{CE(sat)}^*$	Collector-emitter Saturation Voltage	$I_C = 250mA$ $I_B = 25mA$ $I_C = 500mA$ $I_B = 50mA$ $I_C = 1A$ $I_B = 200mA$			0.6 1 2	V V V
V_{BE}^*	Base-emitter Voltage	$I_C = 250mA$ $V_{CE} = 2V$			1	V
h_{FE}^*	DC Current Gain	$I_C = 250mA$ $V_{CE} = 2V$ $I_C = 1A$ $V_{CE} = 2V$	40 5		150	
f_T	Transistion Frequency	$I_C = 100mA$ $V_{CE} = 10V$ $f = 10MHz$	30			MHz
C_{CBO}	Collector-base Capacitance	$I_E = 0$ $V_{CB} = 20V$ $f = 1MHz$			50	pF
h_{fe}	Small Signal Curent Gain	$I_C = 0.2A$ $V_{CE} = 1.5V$ $f = 1KHz$	40			

* Pulsed : pulse duration = 300 μs , duty cycle $\leq 2\%$.

SILICON HIGH POWER TRANSISTORS

DESCRIPTION

The 2N5877 and 2N5878 are silicon epitaxial-base NPN power transistors in Jedec TO-3 metal case. They are intended for use in power linear and switching applications. The complementary PNP types are the 2N5875 and 2N5876 respectively.

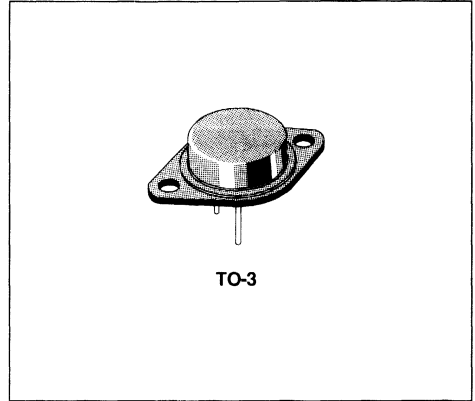

INTERNAL SCHEMATIC DIAGRAMS

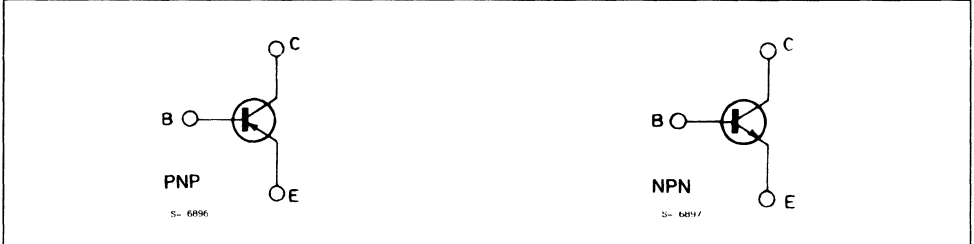

ABSOLUTE MAXIMUM RATINGS

Symbol	Parameter	NPN	2N5877	2N5878	Unit
		PNP	2N5875	2N5876	
V_{CBO}	Collector-base Voltage ($I_E = 0$)		60	80	V
V_{CEO}	Collector-emitter Voltage ($I_B = 0$)		60	80	V
V_{EBO}	Emitter-base Voltage ($I_C = 0$)		5		V
I_C	Collector Current		10		A
I_{CM}	Collector Peak Current		20		A
I_B	Base Current		4		A
P_{tot}	Total Power Dissipation at $T_{case} \leq 25^\circ C$		150		W
T_{stg}	Storage Temperature		- 65 to 200		$^\circ C$
T_j	Junction Temperature		200		$^\circ C$

* For PNP types voltage and current values are negative.

THERMAL DATA

$R_{th\ j-case}$	Thermal Resistance Junction-case	Max	1.17	°C/W
------------------	----------------------------------	-----	------	------

ELECTRICAL CHARACTERISTICS ($T_{case} = 25^{\circ}C$ unless otherwise specified)

Symbol	Parameter	Test Conditions	Min.	Typ.	Max.	Unit
I_{CBO}	Collector Cutoff Current ($I_E = 0$)	for 2N5877/75 $V_{CB} = 60V$ for 2N5878/76 $V_{CB} = 80V$			0.5 0.5	mA mA
I_{CEO}	Collector Cutoff Current ($I_B = 0$)	for 2N5877/75 $V_{CE} = 30V$ for 2N5878/76 $V_{CE} = 40V$			1 1	mA mA
I_{CEX}	Collector Cutoff Current ($V_{BE} = 1.5V$)	for 2N5877/75 $V_{CE} = 60V$ for 2N5878/76 $V_{CE} = 80V$ $T_{case} = 150^{\circ}C$ for 2N5877/75 $V_{CE} = 60V$ for 2N5878/76 $V_{CE} = 80V$			0.5 0.5 5 5	mA mA mA mA
I_{EBO}	Emitter Cutoff Current ($I_C = 0$)	$V_{EB} = 5V$			1	mA
$V_{CEO(sus)}^*$	Collector-emitter Sustaining Voltage ($I_B = 0$)	$I_C = 200mA$ for 2N5877/75 for 2N5878/76	60 80			V V
$V_{CE(sat)}^*$	Collector-emitter Saturation Voltage	$I_C = 5A$ $I_B = 0.5A$ $I_C = 10A$ $I_B = 2.5A$			1 3	V V
$V_{BE(sat)}^*$	Base-emitter Saturation Voltage	$I_C = 10A$ $I_C = 2.5A$			2.5	V
V_{BE}^*	Base-emitter Voltage	$I_C = 4A$ $V_{CE} = 4V$			1.5	V
h_{FE}^*	DC Current Gain	$I_C = 4A$ $V_{CE} = 4V$ $I_C = 10A$ $V_{CE} = 4V$	20 4		100	
f_T	Transition Frequency	$I_C = 0.5V$ $V_{CE} = 10V$	4			MHz
C_{CBO}	Collector-base Capacitance	$V_{CB} = 10V$ $f = 1MHz$ $I_E = 0$ for 2N5877/2N5878 for 2N5875/2N5876			300 500	pF pF
t_r	Rise Time	$I_C = 4A$ $V_{CC} = 30V$ $I_{B1} = 0.4A$			0.7	μs
t_s	Storage Time	$I_C = 4A$ $V_{CC} = 30V$			1	μs
t_f	Fall Time	$I_{B1} = - I_{B2} = 0.4A$			0.8	μs

* Pulsed : pulse duration = 300 μs , duty cycle = 1.5%.
For PNP types voltage and current values are negative.

Safe Operating Areas.

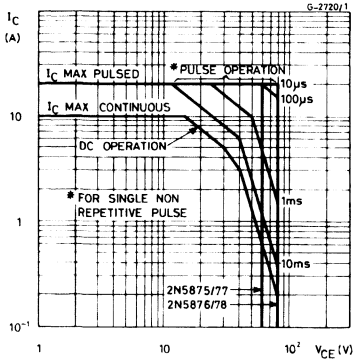

DC Current Gain (NPN types).

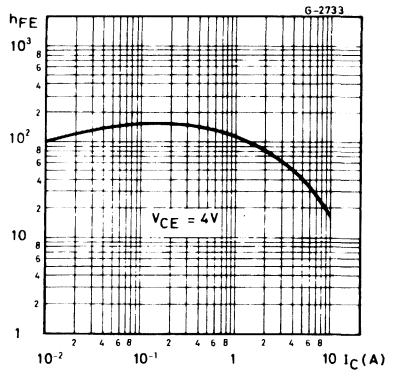

DC Current Gain (PNP types).

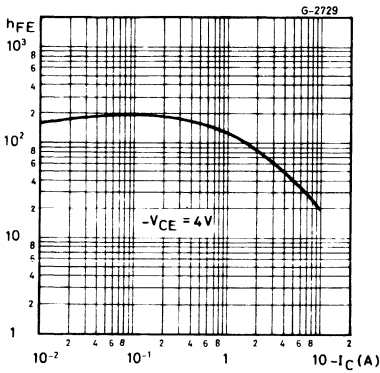

DC Transconductance (NPN types).

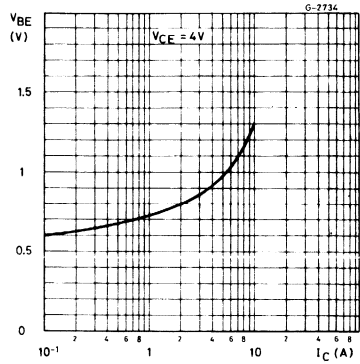

DC Transconductance (PNP types).

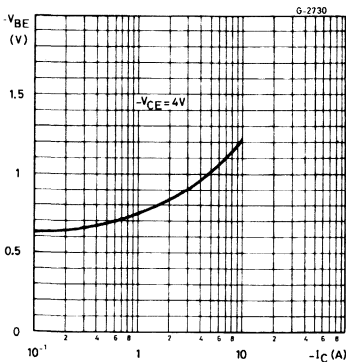

Collector-emitter Saturation Voltage (NPN types).

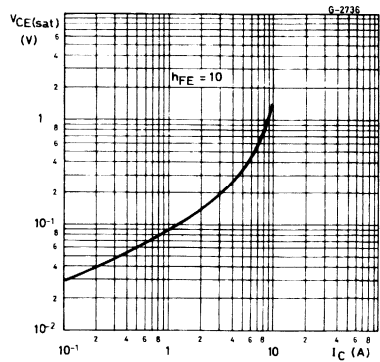

Collector-emitter Saturation Voltage (PNP types).

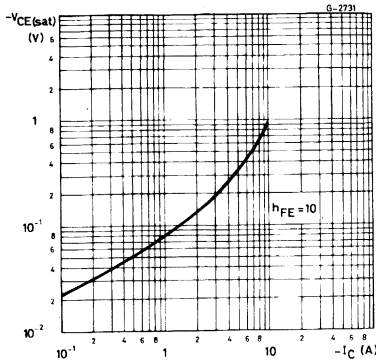

Base-emitter Saturation Voltage (NPN types).

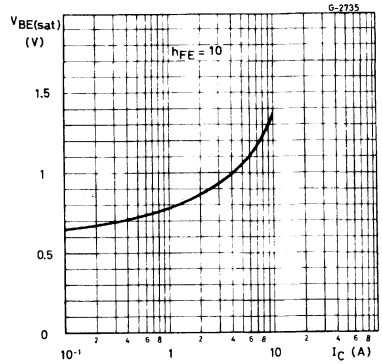

Base-emitter Saturation Voltage (PNP types).

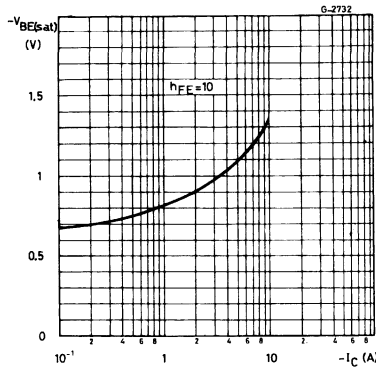

Collector-base Capacitance (NPN types).

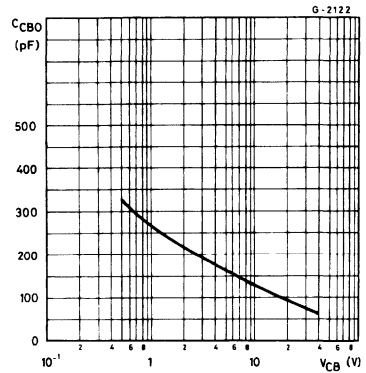

Collector-base Capacitance (NPN types).

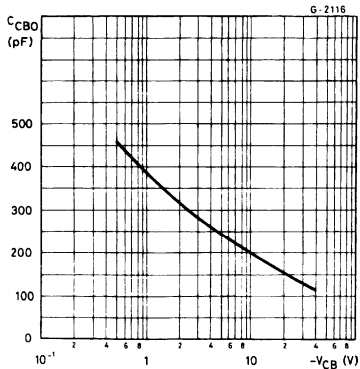

Saturated Switching Characteristics (NPN types).

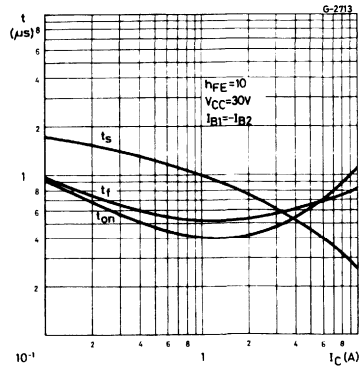

Saturated Switching Characteristics (PNP types).

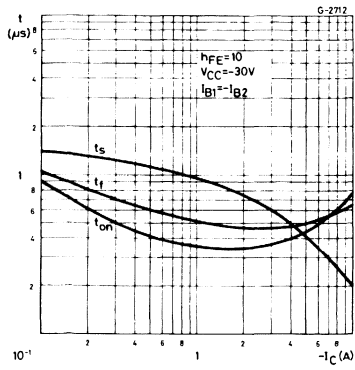

COMPLEMENTARY HIGH-POWER TRANSISTORS

DESCRIPTION

The 2N5885 and 2N5886 are silicon epitaxial-base NPN power transistors in Jedec TO-3 metal case, inted for power linear amplifiers and switching applications. The complementary PNP types are the 2N5883 and 2N5884.

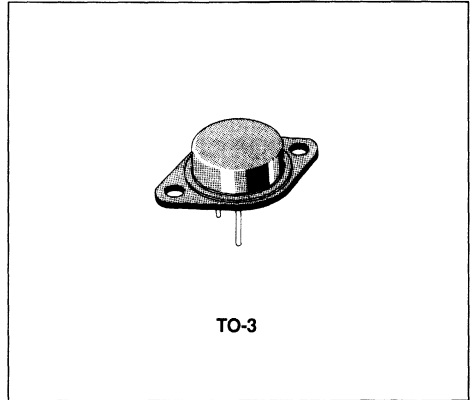

INTERNAL SCHEMATIC DIAGRAMS

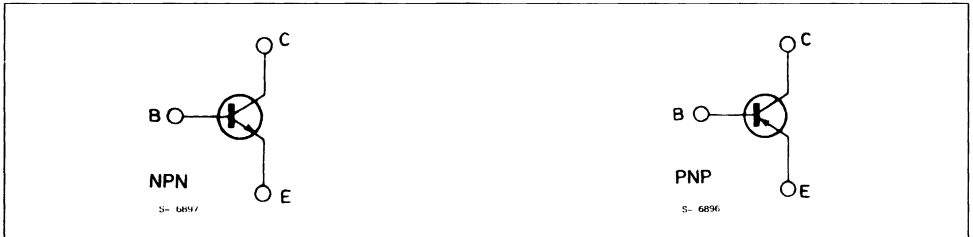

ABSOLUTE MAXIMUM RATINGS

Symbol	Parameter	PNP	2N5883	2N5884	Unit
		NPN	2N5885	2N5886	
V_{CE0}	Collector-emitter Voltage ($I_B = 0$)		60	80	V
V_{CBO}	Collector-base Voltage ($I_E = 0$)		60	80	V
V_{EBO}	Emitter-base Voltage ($I_C = 0$)		5		V
I_C	Collector Current		25		A
I_{CM}	Collector Peak Current		50		A
I_B	Base Current		7.5		A
P_{tot}	Total Power Dissipation at $T_{case} \leq 25^\circ C$		200		W
T_{stg}	Storage Temperature		- 65 to 200		$^\circ C$
T_J	Junction Temperature		200		$^\circ C$

For PNP type voltage and current values are negative.

THERMAL DATA

$R_{th(j-case)}$	Thermal Resistance Junction-case	Max	0.875	°C/W
------------------	----------------------------------	-----	-------	------

ELECTRICAL CHARACTERISTICS ($T_{case} = 25^{\circ}C$ unless otherwise specified)

Symbol	Parameter	Test Conditions	Min.	Typ.	Max.	Unit
I_{CEO}	Collector Cutoff Current ($I_B = 0$)	for 2N5883/5885 $V_{CE} = 30V$ for 2N5884/5886 $V_{CE} = 40V$			2	mA
I_{CEV}	Collector Cutoff Current ($V_{BE} = -1.5V$)	$V_{CE} = \text{rated } V_{CEO}$ $T_{case} = 150^{\circ}C$ $V_{CE} = \text{rated } V_{CEO}$			1 10	mA mA
I_{CBO}	Collector Cutoff Current ($I_E = 0$)	$V_{CB} = \text{rated } V_{CBO}$			1	mA
I_{EBO}	Emitter Cutoff Current ($I_C = 0$)	$V_{EB} = 5V$			1	mA
$V_{CEO(sus)}^*$	Collector-emitter Sustaining Voltage ($I_B = 0$)	$I_C = 200mA$ for 2N5883/5885 for 2N5884/5886	60 80			V V
h_{FE}^*	DC Current Gain	$I_C = 3A$ $V_{CE} = 4V$ $I_C = 10A$ $V_{CE} = 4V$ $I_C = 25A$ $V_{CE} = 4V$	35 20 4		100	
$V_{CE(sat)}^*$	Collector-emitter Saturation Voltage	$I_C = 15A$ $I_B = 1.5A$ $I_C = 25A$ $I_B = 6.25A$			1 4	V V
$V_{BE(sat)}^*$	Base-emitter Saturation Voltage	$I_C = 25A$ $I_B = 6.25A$			2.5	V
V_{BE}^*	Base-emitter Voltage	$I_C = 10A$ $V_{CE} = 4V$			1.5	V
f_T	Transition Frequency	$I_C = 1A$ $V_{CE} = 10V$ $f = 1MHz$	4			MHz
C_{CBO}	Collector Base Capacitance	$V_{CB} = 10V$ $I_E = 0$ $f = 1MHz$ for PNP types			500 1000	pF pF
h_{fe}	Small-signal Current	$I_C = 3A$ $V_{CE} = 4V$ $f = 1KHz$	20			
t_r	Rise Time	$V_{CC} = 30V$ $I_C = 10A$ $I_{B1} = -I_{B2} = 1A$			0.7	μs
t_s	Storage Time				1	μs
t_f	Fall Time				0.8	μs

* Pulsed : pulse duration = 300 μs , duty cycle $\leq 2\%$.
For PNP type voltage and current values are negative.

Safe Operating Areas.

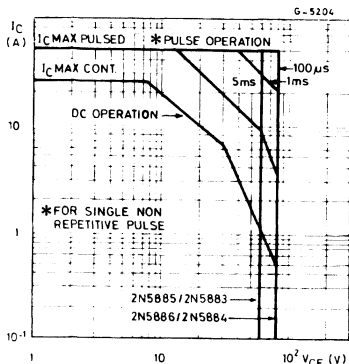

DC Current Gain (NPN types).

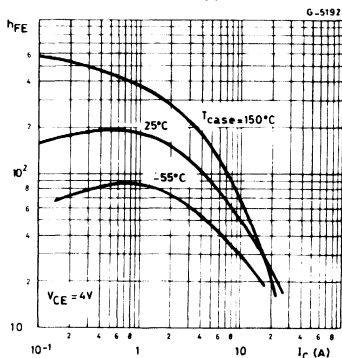

DC Current Gain (PNP type).

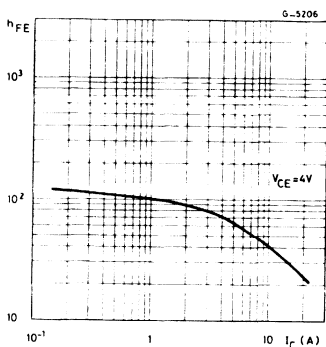

Collector-emitter Saturation Voltage (NPN type).

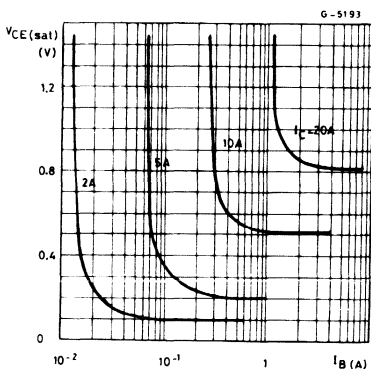

Collector-emitter Saturation Voltage (PNP type).

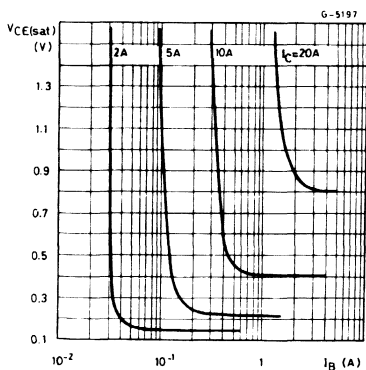

Saturation Voltage (NPN types).

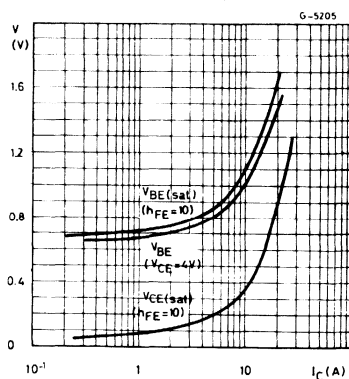

Collector-emitter Saturation Voltage (PNP types).

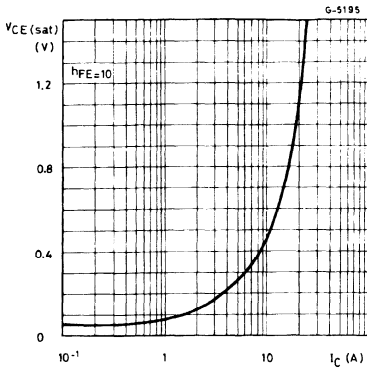

Base-emitter Voltage (PNP types).

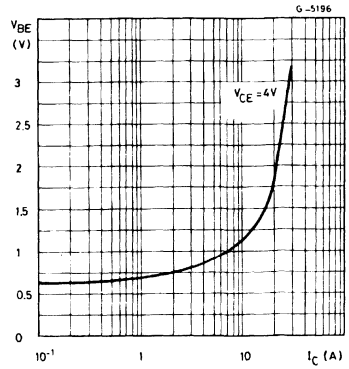

Base-emitter Saturation Voltage (PNP types).

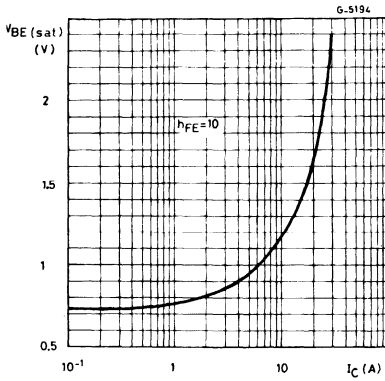

Capacitances (NPN types).

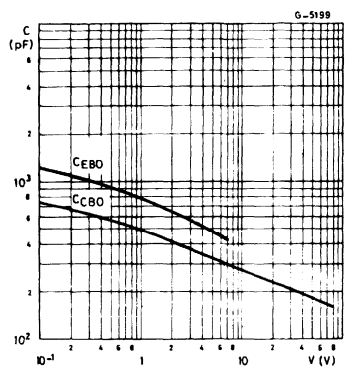

Capacitances (PNP types).

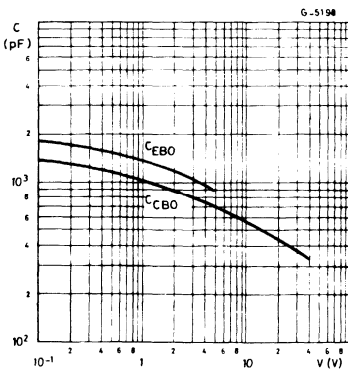

Turn-on Time (NPN types).

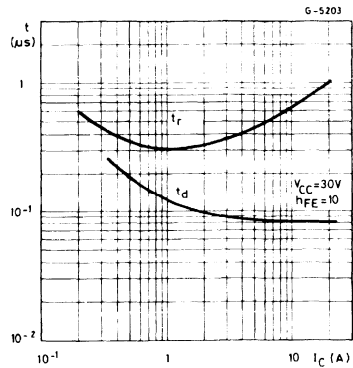

Turn-off Time (NPN types).

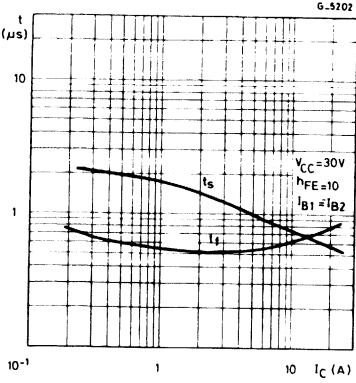

Turn-on Time (PNP types).

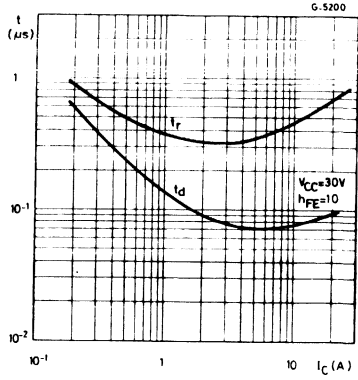

Turn-off Time (PNP types).

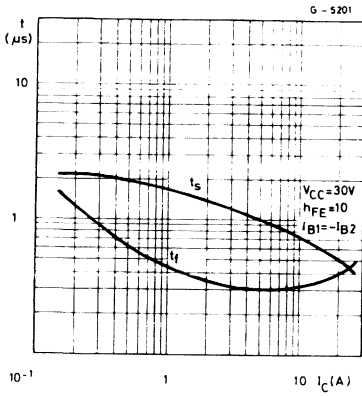

HIGH CURRENT HIGH SPEED HIGH POWER TRANSISTORS

DESCRIPTION

The 2N 6032 and 2N 6033 are silicon multiepitaxial planar NPN transistors in modified Jedec TO-3 metal case.

They have high current, high power handling capability, fast switching speed and are intended for use in switching and linear applications in military and industrial equipment.

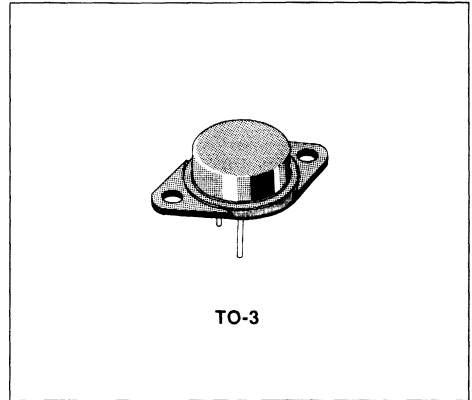

INTERNAL SCHEMATIC DIAGRAM

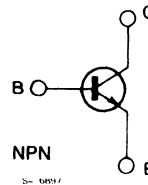

ABSOLUTE MAXIMUM RATINGS

Symbol	Parameter	2N6032	2N6033	Unit
V_{CBO}	Collector-base Voltage ($I_E = 0$)	120	150	V
V_{CEX}	Collector-emitter Voltage ($V_{BE} = -1.5V$, $R_{BE} = 50\Omega$)	120	150	V
V_{CER}	Collector-emitter Voltage ($R_{BE} = 50\Omega$)	110	140	V
V_{CEO}	Collector-emitter Voltage ($I_B = 0$)	90	120	V
V_{EBO}	Emitter-base Voltage ($I_C = 0$)	7	7	V
I_C	Collector Current	50	40	A
I_B	Base Current	10		A
P_{tot}	Total Power Dissipation at $T_{case} \leq 25^\circ C$	140		W
T_{stg}	Storage Temperature	- 65 to 200		$^\circ C$
T_j	Junction Temperature	200		$^\circ C$

THERMAL DATA

$R_{th\ j-case}$	Thermal Resistance Junction-case	Max	1.25	°C/W
------------------	----------------------------------	-----	------	------

ELECTRICAL CHARACTERISTICS ($T_{case} = 25^{\circ}C$ unless otherwise specified)

Symbol	Parameter	Test Conditions	Min.	Typ.	Max.	Unit
I_{CEV}	Collector Cutoff Current ($V_{BE} = -1.5V$)	for 2N6032 $V_{CE} = 110V$ $V_{CE} = 100V$ $T_{case} = 150^{\circ}C$ for 2N6033 $V_{CE} = 135V$ $V_{CE} = 100V$ $T_{case} = 150^{\circ}C$			12 15	mA mA
I_{CEO}	Collector Cutoff Current ($I_B = 0$)	$V_{CE} = 80V$			10	mA
I_{EBO}	Emitter Cutoff Current ($I_C = 0$)	$V_{EB} = 7V$			10	mA
$V_{CEX(sus)}^*$	Collector-emitter Sustaining Voltage ($V_{BE} = -1.5V$, $R_{BE} = 50\Omega$, $L = 2mH$)	$I_C = 200mA$ for 2N6032 for 2N6033	120 150			V V
$V_{CER(sus)}^*$	Collector-emitter Sustaining Voltage ($R_{BE} = 50\Omega$, $L = 15mH$)	$I_C = 200mA$ for 2N6032 for 2N6033	110 140			V V
$V_{CEO(sus)}^*$	Collector-emitter Sustaining Voltage ($I_B = 0$)	$I_C = 200mA$ for 2N6032 for 2N6033	90 120			V V
$V_{CE(sat)}^*$	Collector-emitter Saturation Voltage	for 2N6032 $I_C = 50A$ $I_B = 5A$ for 2N6033 $I_C = 40A$ $I_B = 4A$			1.3 1	V V
$V_{BE(sat)}^*$	Base-emitter Saturation Voltage	for 2N6032 $I_C = 50A$ $I_B = 5A$ for 2N6033 $I_C = 40A$ $I_B = 4A$			2 2	V V
V_{BE}^*	Base-emitter Voltage	for 2N6032 $I_C = 50A$ $V_{CE} = 2V$ for 2N6033 $I_C = 40A$ $V_{CE} = 2V$			2 2	V V
h_{FE}^*	DC Current Gain	for 2N6032 $I_C = 50A$ $V_{CE} = 2.6V$ for 2N6033 $I_C = 40A$ $V_{CE} = 2V$	10 10		50 50	V V
h_{fe}	Small-signal Current Gain	$I_C = 2A$ $V_{CE} = 10V$ $f = 5\text{ MHz}$	10			
C_{CBO}	Collector-base Capacitance	$I_E = 0$ $V_{CB} = 10V$ $f = 1\text{ MHz}$			800	pF

ELECTRICAL CHARACTERISTICS (continued)

Symbol	Parameter	Test Conditions	Min.	Typ.	Max.	Unit
t_r	Rise Time	for 2N6032 $I_C = 50A$ $V_{CC} = 30V$			1	μs
t_s	Storage Time	$I_{B1} = -I_{B2} = 5A$ for 2N6033			1.5	μs
t_f	Fall Time	$I_C = 40A$ $V_{CC} = 30V$ $I_{B1} = -I_{B2} = 4A$			0.5	μs
$I_{s/b}^{**}$	Second Breakdown Collector Current	$V_{CE} = 24V$ $V_{CE} = 40V$	5.8 0.9			A A
$E_{s/b}$	Second Breakdown Energy	$V_{BE} = -4V$ $L = 310\mu H$ $R_{BE} = 5\Omega$	62			mJ

* Pulsed : pulse duration = 300 μs , duty cycle = 1.5 %.
 ** Pulsed : 1 s non repetitive pulse.

Safe Operating Areas.

DC Current Gain.

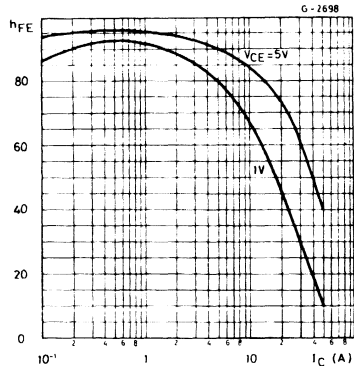
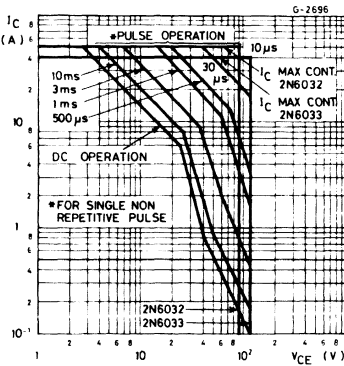

Collector-emitter Saturation Voltage.

Collector-emitter Saturation Voltage.

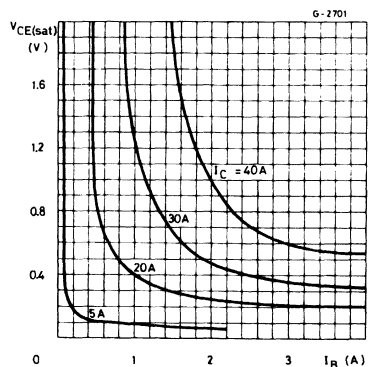
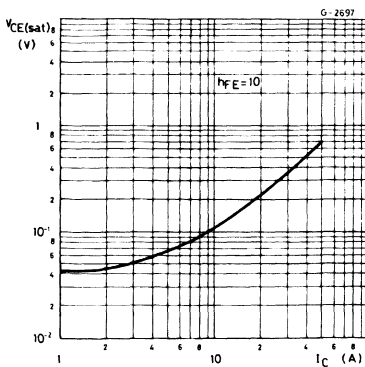

Base-emitter Saturation Voltage.

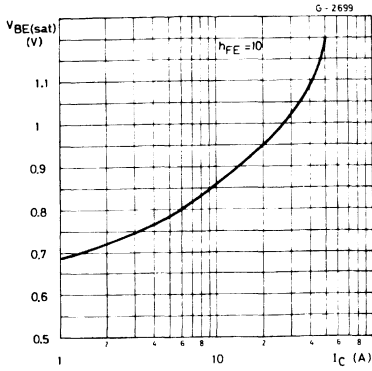

Collector-base Capacitance.

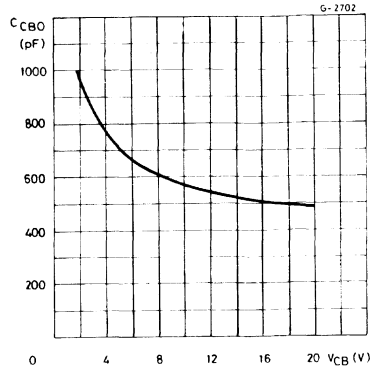

Saturated Switching Characteristics.

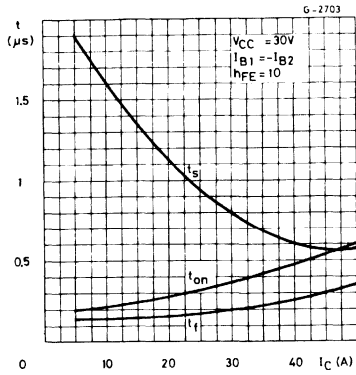

Power Rating Chart.

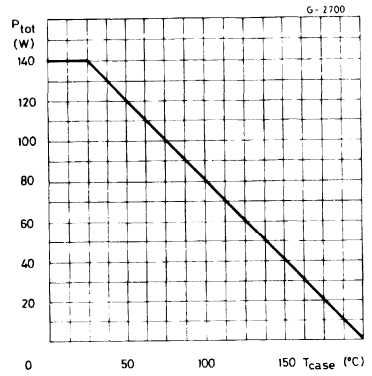

MEDIUM POWER DARLINGTONS

DESCRIPTION

The 2N6037, 2N6038 and 2N6039 are silicon epitaxial-base NPN power transistors in monolithic Darlington configuration and are mounted in Jedec TO-126 plastic package.

The complementary PNP types are the 2N6034, 2N6035 and 2N6036 respectively.

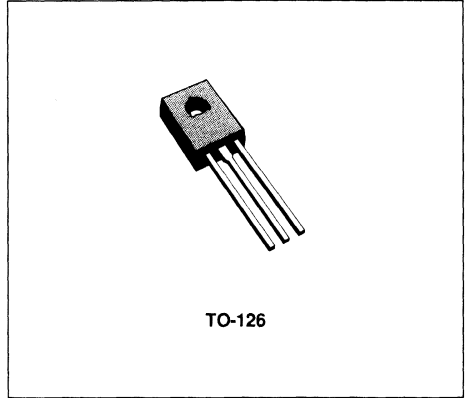

INTERNAL SCHEMATIC DIAGRAMS

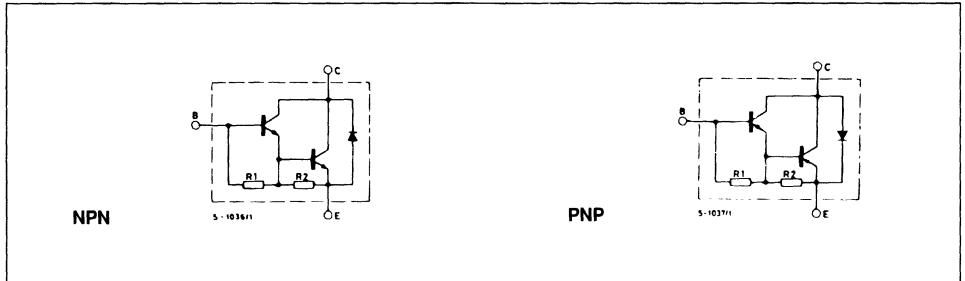

ABSOLUTE MAXIMUM RATINGS

Symbol	Parameter	PNP NPN	2N6034	2N6035	2N6036	Unit
			2N6037	2N6038	2N6039	
V_{CBO}	Collector-base Voltage ($I_E = 0$)		40	60	80	V
V_{CEO}	Collector-emitter Voltage ($I_B = 0$)		40	60	80	V
V_{EBO}	Emitter-base Voltage ($I_C = 0$)			5		V
I_C	Collector Current			4		A
I_{CM}	Collector Peak Current			8		A
I_B	Base Current			100		mA
P_{tot}	Total Power Dissipation at $T_{case} \leq 25^\circ C$			40		W
T_{stg}	Storage Temperature			- 65 to 150		$^\circ C$
T_j	Junction Temperature			150		$^\circ C$

THERMAL DATA

$R_{th\ j-case}$	Thermal Resistance Junction-case	Max	3.12	°C/W
$R_{th\ j-amb}$	Thermal Resistance Junction-ambient	Max	83.3	°C/W

ELECTRICAL CHARACTERISTICS ($T_{case} = 25^{\circ}C$ unless otherwise specified)

Symbol	Parameter	Test Conditions	Min.	Typ.	Max.	Unit
I_{CBO}	Collector Cutoff Current ($I_E = 0$)	for 2N6034/37 $V_{CE} = 40V$ for 2N6035/38 $V_{CE} = 60V$ for 2N6036/39 $V_{CE} = 80V$			100 100 100	μA μA μA
I_{CEO}	Collector Cutoff Current ($I_B = 0$)	for 2N6034/37 $V_{CE} = 40V$ for 2N6035/38 $V_{CE} = 60V$ for 2N6036/39 $V_{CE} = 80V$			100 100 100	μA μA μA
I_{CEX}	Collector Cutoff Current ($V_{EB} = 1.5V$)	for 2N6034/37 $V_{CE} = 40V$ for 2N6035/38 $V_{CE} = 60V$ for 2N6036/39 $V_{CE} = 80V$ $T_{case} = 125^{\circ}C$ for 2N6034/37 $V_{CE} = 40V$ for 2N6035/38 $V_{CE} = 60V$ for 2N6036/39 $V_{CE} = 80V$			0.1 0.1 0.1 0.5 0.5 0.5	mA mA mA mA mA mA
I_{EBO}	Emitter Cutoff Current ($I_C = 0$)	$V_{EB} = 5V$			2	mA
$V_{CEO(sus)}^*$	Collector-emitter Sustaining Voltage ($I_B = 0$)	$I_C = 100mA$ for 2N6034/37 for 2N6035/38 for 2N6036/39	40 60 80			V V V
$V_{CE(sat)}^*$	Collector-emitter Saturation Voltage	$I_C = 2A$ $I_B = 8mA$ $I_C = 4A$ $I_B = 40mA$			2 3	V V
$V_{BE(sat)}^*$	Base-emitter Saturation Voltage	$I_C = 4A$ $I_B = 40mA$			4	V
V_{BE}^*	Base-emitter Voltage	$I_C = 2A$ $V_{CE} = 3V$			2.8	V
h_{FE}^*	DC Current Gain	$I_C = 0.5A$ $V_{CE} = 3V$ $I_C = 2A$ $V_{CE} = 3V$ $I_C = 4A$ $V_{CE} = 3V$	500 750 100		15000	
h_{fe}	Small Signal Current Gain	$I_C = 0.75A$ $V_{CE} = 10V$ $f = 1MHz$	25			
C_{CBO}	Collector-base Capacitance	$V_{CB} = 10V$ $I_E = 0$ $f = 1MHz$			(*)100	

* Pulsed : pulse duration = 300 μs , duty cycle $\leq 1.5\%$.

(*) for PNP types 200pF.

Safe Operating Areas.

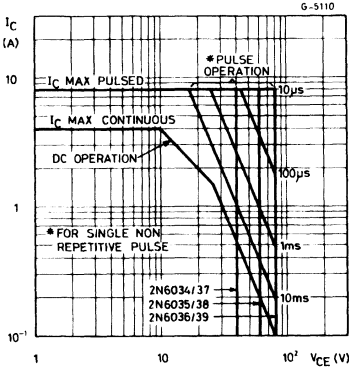

DC Current Gain.

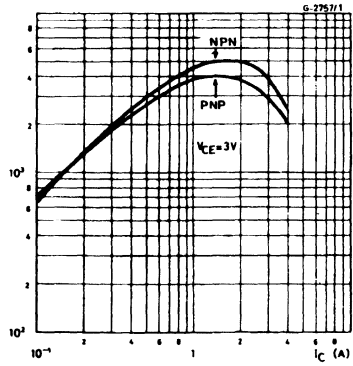

DC Transconductance

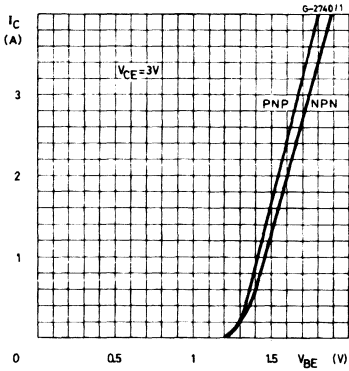

Collector-emitter Saturation Vol-

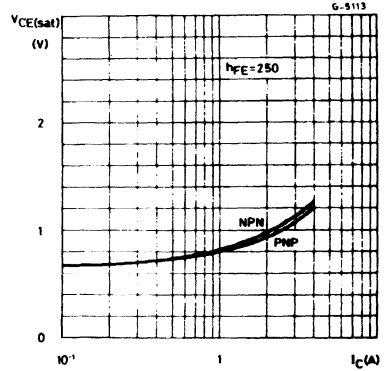

Small Signal Current Gain.

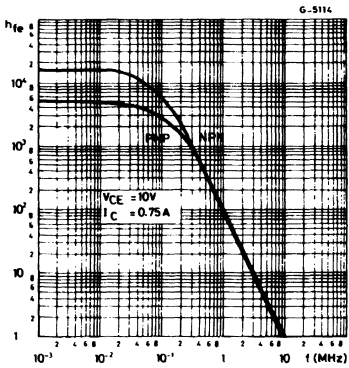

Collector-emitter Saturation Voltage (NPN).

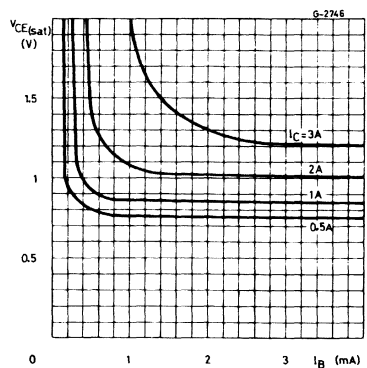

Saturated Switching Characteristics (NPN).

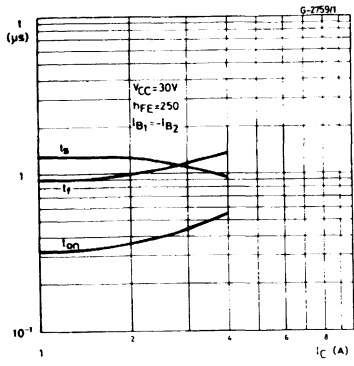

Collector-emitter Saturation Voltage (PNP).

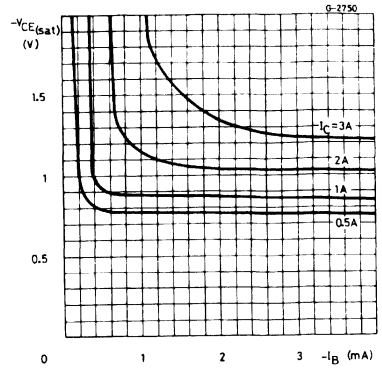

Saturated Switching Characteristics (PNP).

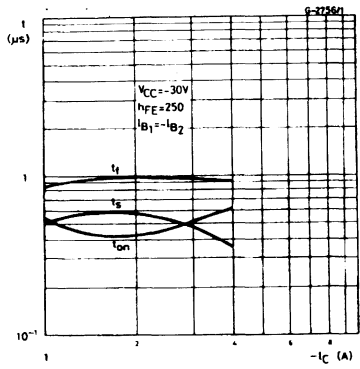

GENERAL PURPOSE
DESCRIPTION

The 2N6045 is a silicon epitaxial-base NPN transistor in monolithic Darlington configuration and is mounted in Jedec TO-220 plastic package. It is intended for use in power linear and switching applications. The complementary PNP type is the 2N6042.

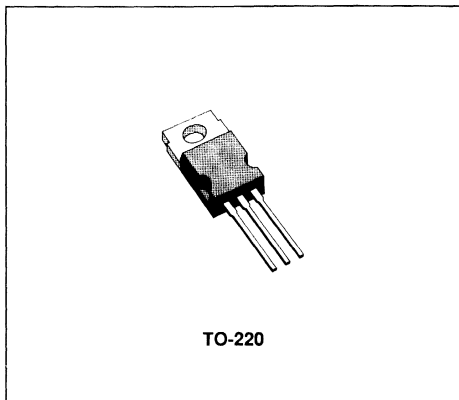
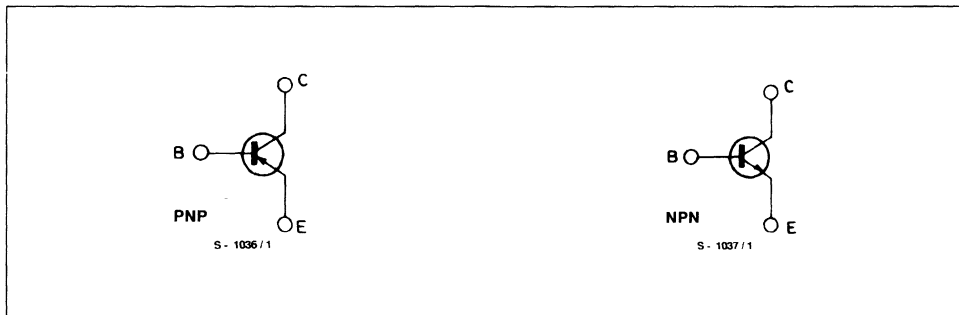
INTERNAL SCHEMATIC DIAGRAMS

ABSOLUTE MAXIMUM RATINGS

Symbol	Parameter	Value	Unit
V_{CBO}	Collector-base Voltage	100	V
V_{CEO}	Collector-emitter Voltage	100	V
I_C	Collector Current	12	A
I_{CM}	Collector Peak Current	15	A
I_B	Base Current	0.2	A
P_{Tot}	Total Power Dissipation at $T_{case} \leq 25^\circ C$	80	W
T_{stg}	Storage Temperature	- 65 to 150	$^\circ C$
T_j	Junction Temperature	150	$^\circ C$

For PNP type voltage and current values are negative.

THERMAL DATA

$R_{th\ j-case}$	Thermal Resistance Junction-case	Max	1.56	°C/W
------------------	----------------------------------	-----	------	------

ELECTRICAL CHARACTERISTICS ($T_{case} = 25\text{ °C}$ unless otherwise specified)

Symbol	Parameter	Test Conditions	Min.	Typ.	Max.	Unit
I_{EBO}	Emitter Cutoff Current ($I_C = 0$)	$V_{EB} = 6\text{ V}$			2	mA
I_{CEO}	Collector Cutoff Current ($I_B = 0$)	$V_{CE} = 100\text{ V}$			20	μA
$V_{CEO(sus)}^*$	Collector-emitter Sustaining Voltage	$I_C = 100\text{ mA}$	100			V
$V_{CE(sat)}^*$	Collector-emitter Saturation Voltage	$I_C = 3\text{ A}$ $I_B = 12\text{ mA}$ $I_C = 8\text{ A}$ $I_B = 80\text{ mA}$			2 4	V V
$V_{BE(sat)}^*$	Base-emitter Saturation Voltage	$I_C = 8\text{ A}$ $I_B = 80\text{ mA}$			4.5	V
$V_{BE(on)}^*$	Base-emitter Voltage	$I_C = 4\text{ A}$ $V_{CE} = 4\text{ V}$			2.8	V
h_{FE}	DC Current Gain	$I_C = 3\text{ A}$ $V_{CE} = 4\text{ V}$ $I_C = 8\text{ A}$ $V_{CE} = 4\text{ V}$	1000 100		20000	
h_{fe}	Small Signal Current Gain	$I_C = 3\text{ A}$ $V_{CE} = 4\text{ V}$ $f = 1\text{ MHz}$	4			
C_{CBO}	Collector-base Capacitance ($I_E = 0$)	$V_{CB} = 10\text{ V}$ $f = 0.1\text{ MHz}$			300	pF

* Pulsed : pulse duration = $300\mu\text{s}$, duty cycle = 1.5 %.
For PNP type voltage and current values are negative.



COMPLEMENTARY DARLINGTON

- HIGH GAIN
- HIGH CURRENT
- HIGH DISSIPATION

DESCRIPTION

The 2N6050, 2N6051 and 2N6052 are silicon epitaxial base PNP transistors in monolithic Darlington configuration mounted in Jeduc TO-3 metal case.

They are intended for use in power linear and low frequency switching applications.

The complementary NPN types are the 2N6057, 2N6058 and 2N6059 respectively.

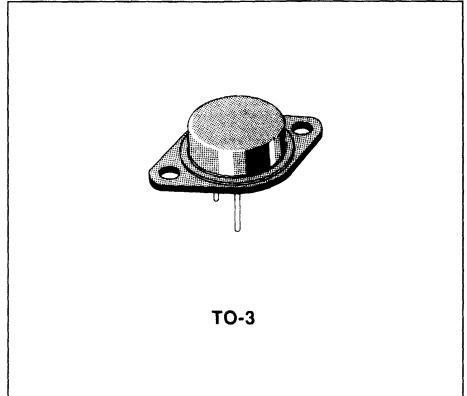

INTERNAL SCHEMATIC DIAGRAM

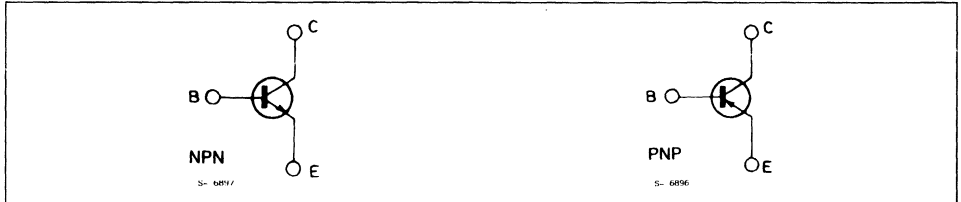

ABSOLUTE MAXIMUM RATINGS

Symbol	Parameter	PNP NPN	Value			Unit
			2N6050 2N6057	2N6051 2N6058	2N6052 2N6059	
V _{CBO}	Collector-base Voltage (I _E = 0)		60	80	100	V
V _{CEX}	Collector-emitter Voltage (V _{BE} = - 1.5V)		60	80	100	V
V _{CEO}	Collector-emitter Voltage (I _B = 0)		60	80	100	V
V _{EBO}	Emitter-base Voltage (I _C = 0)		5			V
I _C	Collector Current		12			A
I _{CM}	Collector Peak Current		20			A
I _B	Base Current		0.2			mA
P _{tot}	Total Dissipation at T _c < 25°C		150			W
T _{stg}	Storage Temperature		- 65 to 200			°C
T _j	Max. Operating Junction Temperature		200			°C

For PNP types voltage and current value are negative.

THERMAL DATA

$R_{thj-case}$	Thermal Resistance Junction-case	max	1.17	°C/W
----------------	----------------------------------	-----	------	------

ELECTRICAL CHARACTERISTICS ($T_{case} = 25^{\circ}C$ unless otherwise specified)

Symbol	Parameter	Test Conditions	Min.	Typ.	Max.	Unit
I_{CEX}	Collector Cutoff Current	$V_{CE} = V_{CEX}, V_{BE} = -1.5V$ $V_{CE} = V_{CEX}, V_{BE} = -1.5V, T_c = 150^{\circ}C$			500 5	μA mA
I_{CEO}	Collector Cutoff Current ($I_B = 0$)	$V_{CE} = 30V$ for 2N6050/57 $V_{CE} = 40V$ for 2N6051/58 $V_{CE} = 50V$ for 2N6052/59			1 1 1	mA mA mA
I_{EBO}	Emitter Cutoff Current ($I_C = 0$)	$V_{EB} = 5V$			2	mA
$V_{CEO(sus)}^*$	Collector-emitter Sustaining Voltage	$I_C = 0.1A$ for 2N6050/57 for 2N6051/58 for 2N6052/59	60 80 100			V V V
$V_{CE(sat)}^*$	Collector-emitter Saturation Voltage	$I_C = 6A, I_B = 24mA$ $I_C = 12A, I_B = 120mA$			2 3	V V
$V_{BE(sat)}^*$	Base-emitter Saturation Voltage	$I_C = 12A, I_B = 120mA$			4	V
$V_{BE(on)}^*$	Base-emitter Voltage	$I_C = 6A, V_{CE} = 3V$			2.8	V
h_{FE}^*	DC Current Gain	$I_C = 6A, V_{CE} = 3V$ $I_C = 12A, V_{CE} = 3V$	750 100			
f_T	Transition Frequency	$I_C = 5A, V_{CE} = 3V, f = 1MHz$	4			MHz

* Pulsed : pulse duration = 300 μs , duty cycle = 1.5%.
For PNP types voltage and current values are negative.

COMPLEMENTARY POWER DARLINGTON

DESCRIPTION

The 2N6053 is a silicon epitaxial base PNP transistor in monolithic Darlington configuration and are mounted in Jedec TO-3 metal case. They are intended for use in power linear and switching applications.

The complementary NPN type is the 2N6055.

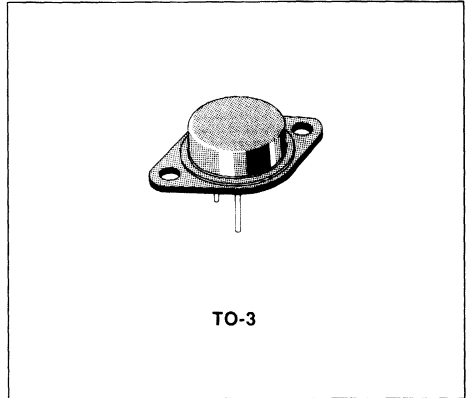

INTERNAL SCHEMATIC DIAGRAM

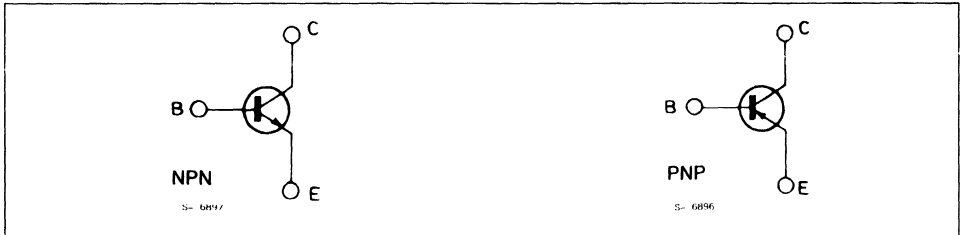

ABSOLUTE MAXIMUM RATINGS

Symbol	Parameter	PNP NPN	Value	Unit
			2N6053 2N6055	
V_{CBO}	Collector-base Voltage ($I_E = 0$)		60	V
V_{CEO}	Collector-emitter Voltage ($I_B = 0$)		60	V
V_{EBO}	Emitter-base Voltage ($I_C = 0$)		5	V
I_C	Collector Current		8	A
I_{CM}	Collector Peak Current		16	A
I_B	Base Current		120	mA
P_{tot}	Total Dissipation at $T_c < 25^\circ\text{C}$		100	W
T_{stg}	Storage Temperature		- 65 to 200	$^\circ\text{C}$
T_j	Max. Operating Junction Temperature		200	$^\circ\text{C}$

For PNP type voltage and current values are negative.

THERMAL DATA

R _{thj-case}	Thermal Resistance Junction-case	max	1.75	°C/W
-----------------------	----------------------------------	-----	------	------

ELECTRICAL CHARACTERISTICS (T_{case} = 25°C unless otherwise specified)

Symbol	Parameter	Test Conditions	Min.	Typ.	Max.	Unit
I _{CEX}	Collector Cutoff Current	V _{CE} = 60V V _{BE} = -1.5V V _{CE} = 60V V _{BE} = -1.5V T _c = 150°C			500 5	μA mA
I _{CEO}	Collector Cutoff Current (I _B = 0)	V _{CE} = 30V			0.5	mA
I _{EBO}	Emitter Cutoff Current (I _C = 0)	V _{EB} = 5V			2	mA
V _{CE0(sus)*}	Collector-emitter Sustaining Voltage	I _C = 100mA	60			V
V _{CE(sat)*}	Collector-emitter saturation Voltage	I _C = 4A I _B = 16mA I _C = 8A I _B = 80mA			2 3	V V
V _{BE(sat)*}	Base-emitter Saturation Voltage	I _C = 8A I _B = 80mA			4	V
V _{BE(on)*}	Base-emitter Voltage	I _C = 4A V _{CE} = 3V			2.8	V
h _{FE} *	DC Current Gain	I _C = 4A V _{CE} = 3V I _C = 8A V _{CE} = 3V	750 100		18K	
f _T	Transition Frequency	I _C = 3A V _{CE} = 3V f = 1MHz	4			MHz
C _{cbo}	Collector-base Capacitance	V _{CB} = 10V I _E = 0 f = 1MHz for NPN Type for PNP Type			200 300	pF pF

* Pulsed : pulse duration = 300μs, duty cycle = 1.5%.
For PNP type voltage and current values are negative.

GENERAL PURPOSE COMPLEMENTARY PAIRS

DESCRIPTION

The 2N6107, 2N6109, 2N6111, 2N6288, 2N6290 and 2N6292 are epitaxial-base silicon transistors in Jedec TO-220 plastic package. They are intended for a wide variety of medium power switching and linear applications.

The PNP types are the 2N6107, 2N6109, 2N6111 and their complementary NPN types are the 2N6292, 2N6290 and 2N6288 respectively.

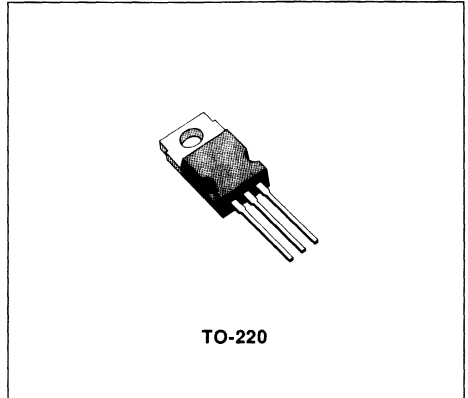

INTERNAL SCHEMATIC DIAGRAMS

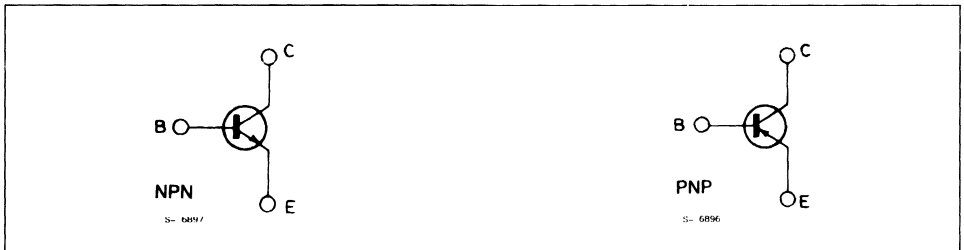

ABSOLUTE MAXIMUM RATINGS

Symbol	Parameter	PNP	2N6107	2N6109	2N6111	Unit
		NPN	2N6292	2N6290	2N6288	
V_{CBO}	Collector-base Voltage ($I_E = 0$)		80	60	40	V
V_{CEX}	Collector-emitter Voltage ($R_{BE} = 100 \Omega$)		80	60	40	V
V_{CEO}	Collector-emitter Voltage ($I_B = 0$)		70	50	30	V
V_{EBO}	Emitter-base Voltage ($I_C = 0$)		5			V
I_C	Collector Current		7			A
I_B	Base Current		3			A
P_{tot}	Total Power Dissipation at $T_{case} \leq 25^\circ C$		40			W
T_{stg}	Storage Temperature		- 65 to 150			$^\circ C$
T_j	Junction Temperature		150			$^\circ C$

For PNP devices voltage and current values are negative.

THERMAL DATA

$R_{th\ j-case}$	Thermal Resistance Junction-case	Max	3.12	°C/W
$R_{th\ j-amb}$	Thermal Resistance Junction-ambient	Max	70	°C/W

ELECTRICAL CHARACTERISTICS ($T_{case} = 25\ ^\circ C$ unless otherwise specified)

Symbol	Parameter	Test Conditions	Min.	Typ.	Max.	Unit	
I_{CEX}	Collector Cutoff Current ($V_{BE} = -1.5\ V$)	$V_{CE} = 40\ V$ for 2N6111/2N6288			0.1	mA	
		$V_{CE} = 60\ V$ for 2N6109/2N6290			0.1	mA	
		$V_{CE} = 80\ V$ for 2N6107/2N6292			0.1	mA	
		$T_C = 150\ ^\circ C$					
		$V_{CE} = 30\ V$ for 2N6111/2N6288				2	mA
I_{CEO}	Collector Cutoff Current ($I_B = 0$)	$V_{CE} = 20\ V$ for 2N6111/2N6288			1	mA	
		$V_{CE} = 40\ V$ for 2N6109/2N6290			1	mA	
		$V_{CE} = 60\ V$ for 2N6107/2N6292			1	mA	
I_{EBO}	Emitter Cutoff Current ($I_C = 0$)	$V_{EB} = 5\ V$			1	mA	
$V_{CEO(sus)}^*$	Collector Emitter Sustaining Voltage	$I_C = 0.1\ A$ for 2N6111/2N6288 for 2N6109/2N6290 for 2N6107/2N6292	30 50 70			V V V	
$V_{CEr(sus)}^*$	Collector Emitter Sustaining Voltage	$I_C = 0.1\ A$ $R_{BE} = 100\ ohm$ for 2N6111/2N6288 for 2N6109/2N6290 for 2N6107/2N6292	40 60 80			V V V	
$V_{CE(sat)}^*$	Collector-emitter Saturation Voltage	$I_C = 2\ A$ $I_B = 0.2\ A$ for 2N6111/2N6288			1	V	
		$I_C = 2.5\ A$ $I_B = 0.25\ A$ for 2N6109/2N6290			1	V	
		$I_C = 3\ A$ $I_B = 0.3\ A$ for 2N6107/2N6292			1	V	
		$I_C = 7\ A$ $I_B = 3\ A$			3.5	V	
$V_{BE(on)}^*$	Base-emitter Voltage	$I_C = 2\ A$ $V_{CE} = 4\ A$ for 2N6111/2N6288			1.5	V	
		$I_C = 2.5\ A$ $V_{CE} = 4\ A$ for 2N6109/2N6290			1.5	V	
		$I_C = 3\ A$ $V_{CE} = 4\ A$ for 2N6107/2N6292			1.5	V	
		$I_C = 7\ A$ $V_{CE} = 4\ A$			3	V	
h_{FE}^*	DC Current Gain	$I_C = 2\ A$ $V_{CE} = 4\ A$ for 2N6111/2N6288	30		150		
		$I_C = 2.5\ A$ $V_{CE} = 4\ A$ for 2N6109/2N6290	30		150		
		$I_C = 3\ A$ $V_{CE} = 4\ A$ for 2N6107/2N6292	30		150		
		$I_C = 7\ A$ $V_{CE} = 4\ A$	2.3				
h_{fe}	Small Signal Current Gain	$I_C = 0.5\ A$ $V_{CE} = 4\ V$ $f = 50\ KHz$	20				
f_T	Transition Frequency	$I_C = 0.5\ A$ $V_{CE} = 4\ V$ for NPN Types	10			MHz	
		$I_C = 0.5\ A$ $V_{CE} = 4\ V$ for PNP Types	4			MHz	
C_{cbo}	Collector-base Capacitance	$V_{CB} = 10\ V$ $f = 1\ MHz$			250	pF	

* Pulsed : pulse duration = 300µs, duty cycle = 1.5 %.
 For PNP types voltage and current values are negative.
 For characteristic curves see the BD533 (NPN) and BD534 (PNP) series.

MEDIUM POWER LINEAR AND SWITCHING APPLICATIONS

DESCRIPTION

The 2N6121, 2N6122 and 2N6123 are silicon epitaxial-base NPN power transistors in Jedec TO-220 plastic package, intended for use in medium power linear and switching applications.

The complementary PNP types are the 2N6124, 2N6125 and 6126 respectively.

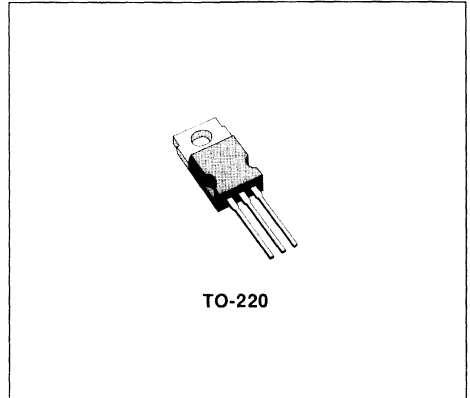

INTERNAL SCHEMATIC DIAGRAMS

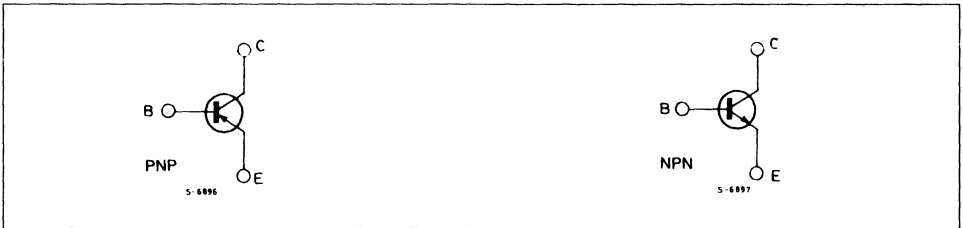

ABSOLUTE MAXIMUM RATINGS

Symbol	Parameter	NPN PNP*			Unit
		2N6121 2N6124	2N6122 2N6125	2N6123 2N6126	
V_{CBO}	Collector-base Voltage ($I_E = 0$)	45	60	80	V
V_{CES}	Collector-emitter Voltage ($V_{BE} = 0$)	45	60	80	V
V_{CEO}	Collector-emitter Voltage ($I_B = 0$)	45	60	80	V
V_{EBO}	Emitter-base Voltage ($I_C = 0$)	5			V
I_C	Collector Current	4			A
I_{CM}	Collector Peak Current	7			A
I_B	Base Current	1			A
P_{tot}	Total Power Dissipation at $T_{case} \leq 25^\circ C$	40			W
T_{stg}	Storage Temperature	- 65 to 150			$^\circ C$
T_j	Junction Temperature	150			$^\circ C$

For PNP type voltage and current values are negative.

THERMAL DATA

$R_{th\ j-case}$	Thermal Resistance Junction-case	Max	3.12	°C/W
$R_{th\ j-amb}$	Thermal Resistance Junction-ambient	Max	70	°C/W

ELECTRICAL CHARACTERISTICS ($T_{case} = 25\text{ °C}$ unless otherwise specified)

Symbol	Parameter	Test Conditions	Min.	Typ.	Max.	Unit
I_{CBO}	Collector cutoff Current ($I_E = 0$)	for 2N6121/24 $V_{CB} = 45\text{ V}$ for 2N6122/25 $V_{CB} = 60\text{ V}$ for 2N6123/26 $V_{CB} = 80\text{ V}$			100 100 100	μA μA μA
I_{CEX}	Collector cutoff Current ($V_{BE} = -1.5\text{ V}$)	for 2N6121/24 $V_{CE} = 45\text{ V}$ for 2N6122/25 $V_{CE} = 60\text{ V}$ for 2N6123/26 $V_{CE} = 80\text{ V}$ $T_{case} = 125\text{ °C}$ for 2N6121/24 $V_{CE} = 45\text{ V}$ for 2N6122/25 $V_{CE} = 60\text{ V}$ for 2N6123/26 $V_{CE} = 80\text{ V}$			100 100 100 2 2 2	μA μA μA μA μA μA
I_{CEO}	Collector cutoff Current ($I_B = 0$)	for 2N6121/24 $V_{CE} = 45\text{ V}$ for 2N6122/25 $V_{CE} = 60\text{ V}$ for 2N6123/26 $V_{CE} = 80\text{ V}$			1 1 1	mA mA mA
I_{EBO}	Emitter cutoff Current ($I_C = 0$)	$V_{EB} = 5\text{ V}$			1	mA
$V_{CEO(sus)}^*$	Collector-emitter Sustaining Voltage ($I_B = 0$)	$I_C = 100\text{ mA}$	for 2N6121/24 for 2N6122/25 for 2N6123/26	45 60 80		V V V
$V_{CE(sat)}^*$	Collector-emitter Saturation Voltage	$I_C = 1.5\text{ A}$ $I_C = 4\text{ A}$	$I_B = 0.15\text{ A}$ $I_B = 1\text{ A}$		0.6 1.4	V V
V_{BE}^*	Base-emitter Voltage	$I_C = 1.5\text{ A}$	$V_{CE} = 2\text{ V}$		1.2	V
h_{FE}^*	DC Current Gain	$I_C = 1.5\text{ A}$ $I_C = 4\text{ A}$	$V_{CE} = 2\text{ V}$ for 2N6121/24 for 2N6122/25 for 2N6123/26 $V_{CE} = 2\text{ V}$ for 2N6121/24 for 2N6122/25 for 2N6123/26	25 25 20 10 10 7	100 100 80	
h_{fe}	Small Signal Current Gain	$I_C = 1\text{ A}$ $f = 1\text{ MHz}$	$V_{CE} = 4\text{ V}$	2.5		

* Pulsed : pulse duration = 300 μs , duty cycle = 1.5 %..
For PNP types voltage and current values are negative.

Safe Operating Areas.

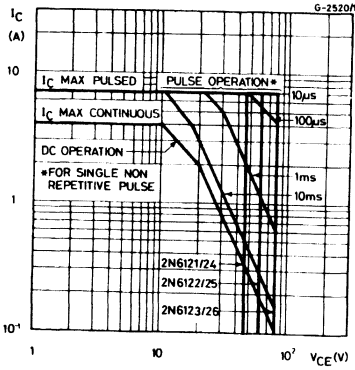

Power Rating Chart.

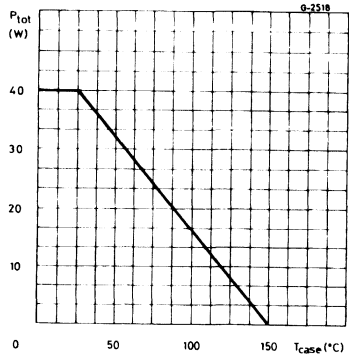

DC Current Gain (NPN types).

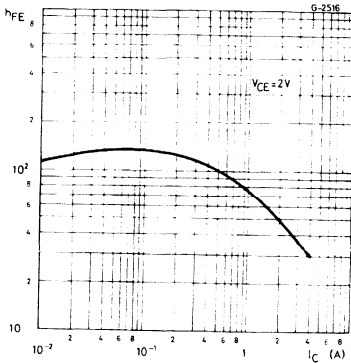

DC Current Gain (PNP types).

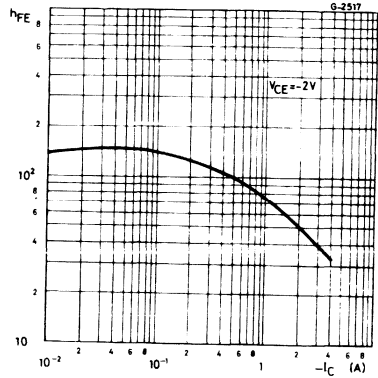

Collector-emitter Saturation Voltage (NPN types).

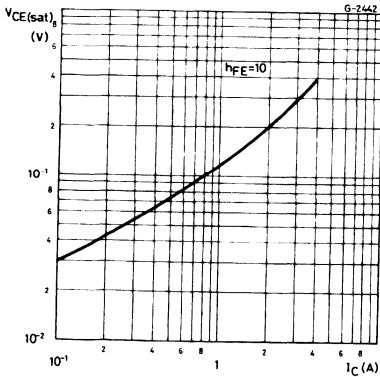

Collector-emitter Saturation Voltage (PNP types).

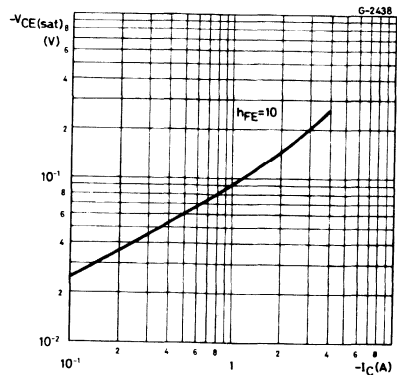

Base-emitter Saturation Voltage (NPN types).

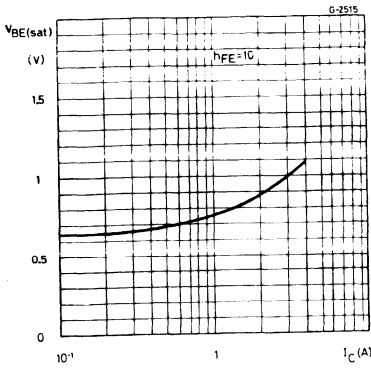

Base-emitter Saturation Voltage (PNP types).

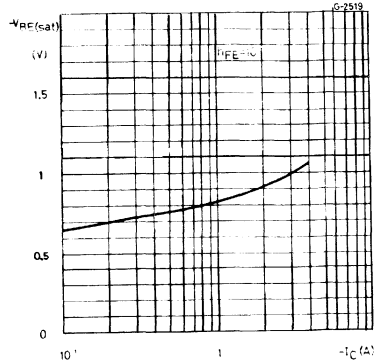

Collector-base Capacitance (NPN types).

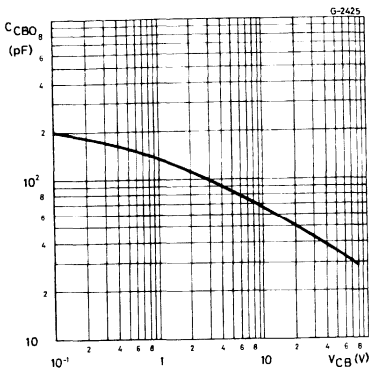

Collector-base Capacitance (PNP types).

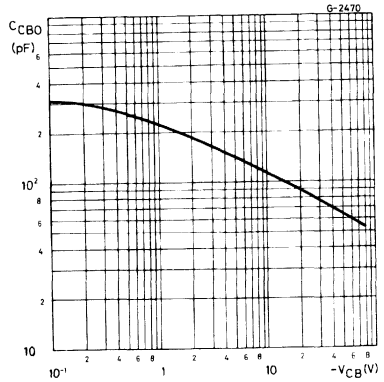

Transition Frequency (NPN types).

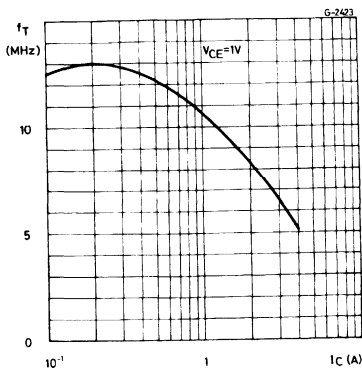

Transition Frequency (PNP types).

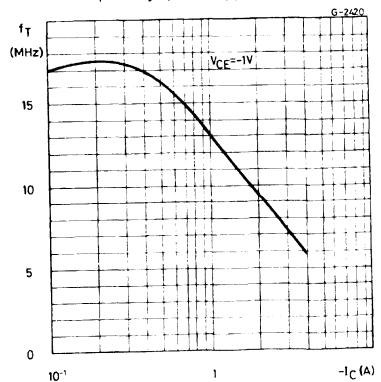

Saturated Switching Characteristics (NPN types).

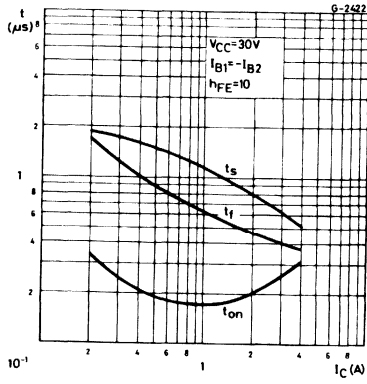

Saturated Switching Characteristics (PNP types).

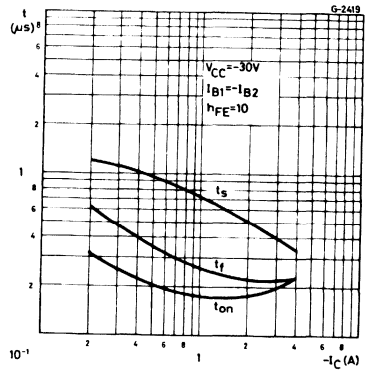

COMPLEMENTARY POWER DARLINGTONS

DESCRIPTION

The 2N6282, 2N6283 and 2N6284 and the complementary PNP types 2N6285, 2N6286, 2N6287 are epitaxial-base silicon transistors in monolithic Darlington configuration in Jedec TO-3 metal Case. They are intended for general-purpose amplifier and low-frequency switching applications.

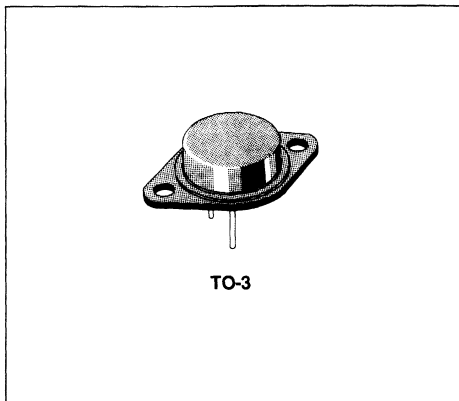

INTERNAL SCHEMATIC DIAGRAMS

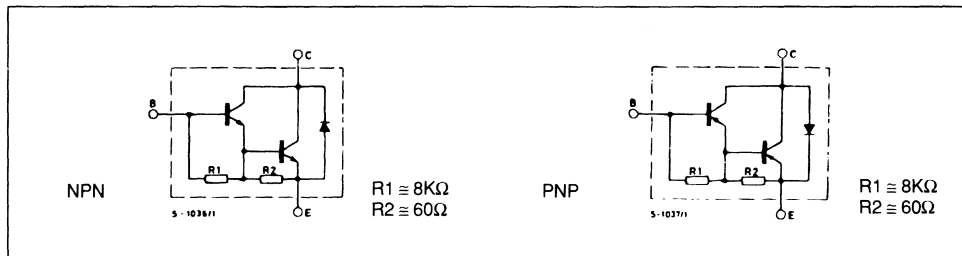

ABSOLUTE MAXIMUM RATINGS

Symbol	Parameter	PNP	2N6282	2N6283	2N6284	Unit
		NPN	2N6285	2N6286	2N6287	
V_{CE0}	Collector-emitter Voltage ($I_B = 0$)		60	80	100	V
V_{CBO}	Collector-base Voltage ($I_E = 0$)		60	80	100	V
V_{EBO}	Emitter-base Voltage ($I_C = 0$)			5		V
I_C	Collector Current			20		A
I_{CM}	Collector Peak Current			40		A
I_B	Base Current			0.5		A
P_{tot}	Total Power Dissipation at $T_{case} \leq 25^\circ C$			160		W
T_{stg}	Storage Temperature			- 65 to 200		$^\circ C$
T_j	Junction Temperature			200		$^\circ C$

For PNP types voltage and current values are negative.

THERMAL DATA

$R_{th\ j-case}$	Thermal Resistance Junction-case	Max	1.09	$^{\circ}C/W$
------------------	----------------------------------	-----	------	---------------

ELECTRICAL CHARACTERISTICS ($T_{case} = 25^{\circ}C$ unless otherwise specified)

Symbol	Parameter	Test Conditions	Min.	Typ.	Max.	Unit
I_{CEO}	Collector Cutoff Current ($I_B = 0$)	for 2N6282, 2N6285 $V_{CE} = 30V$ for 2N6283, 2N6286 $V_{CE} = 40V$ for 2N6284, 2N6287 $V_{CE} = 50V$			1	mA
I_{EBO}	Emitter Cutoff Current ($I_C = 0$)	$V_{EB} = 5V$			2	mA
I_{CEV}	Collector Cutoff Current ($V_{BE} = -1.5V$)	$V_{CE} = \text{rated } V_{CBO}$ $V_{CE} = \text{rated } V_{CBO}$ $T_{case} = 150^{\circ}C$			0.5 5	mA mA
$V_{CEO(sus)}^*$	Collector-emitter Sustaining Voltage ($I_B = 0$)	$I_C = 0.1A$ for 2N6282, 2N6285 for 2N6283, 2N6286 for 2N6284, 2N6287	60 80 100			V V V
$V_{CE(sat)}^*$	Base-emitter Saturation Voltage	$I_C = 10A$ $I_B = 40mA$ $I_C = 20A$ $I_B = 200mA$			2 3	V V
$V_{BE(sat)}^*$	Collector-emitter Saturation Voltage	$I_C = 20A$ $I_B = 200mA$			4	V
V_{BE}^*	Base-emitter Voltage	$I_C = 10A$ $V_{CE} = 3V$			2.8	V
h_{FE}^*	DC Current Gain	$I_C = 10A$ $V_{CE} = 3V$ $I_C = 20A$ $V_{CE} = 3V$	750 100		18000	
C_{CBO}	Collector-base Capacitance	$V_{CB} = 10V$ $I_E = 0$ $f = 0.1MHz$ for 2N6282, 2N6283, 2N6284 for 2N6285, 2N6286, 2N6287			400 600	pF pF
h_{fe}	Small Signal Current Gain	$I_C = 10A$ $V_{CE} = 3V$ $f = 1KHz$	300			

* Pulsed : pulse duration = 300 μ s, duty cycle \leq 2%.
For PNP types voltage and current values are negative.

Safe Operating Areas.

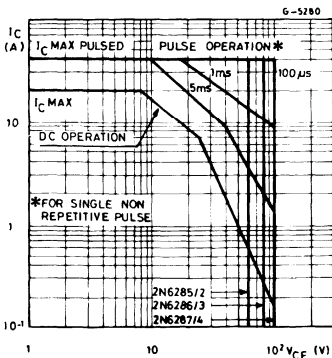

DC Current Gain (NPN types).

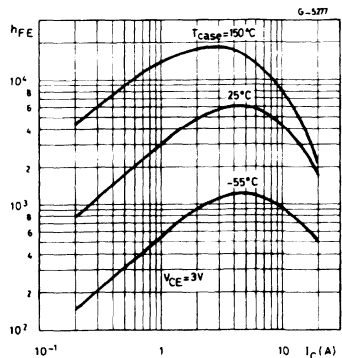

DC Current Gain (PNP types).

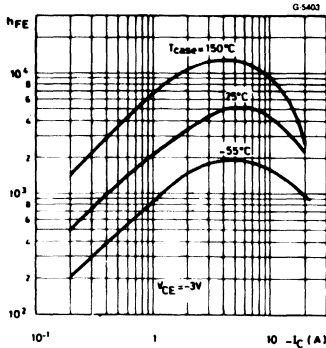

Collector-emitter Saturation Voltage (NPN types).

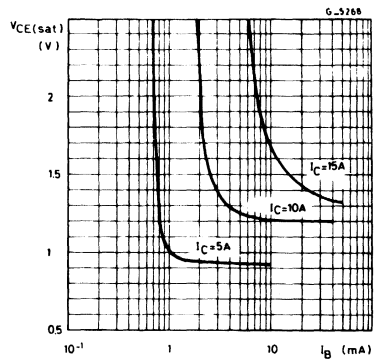

Collector-emitter saturation Voltage (PNP types).

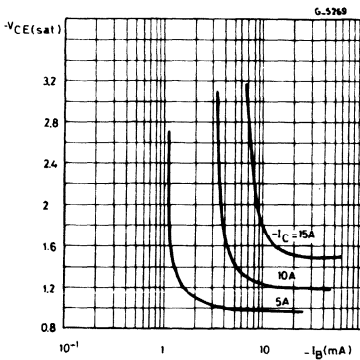

Saturation Voltages (NPN types).

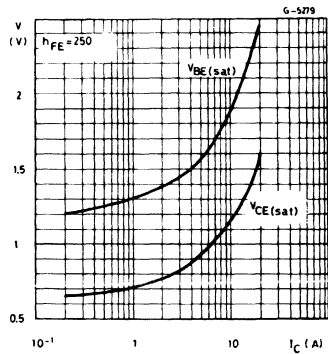

Saturation Voltages (PNP).

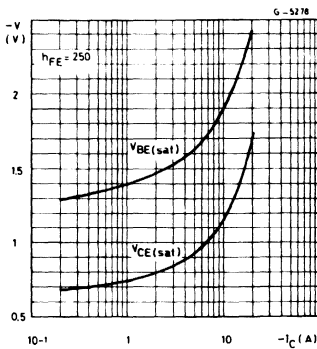

Small Signal Current Gain (NPN types).

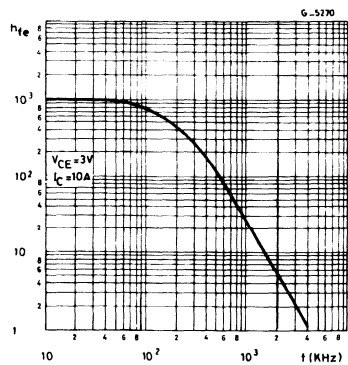

Small Signal Current Gain (PNP types).

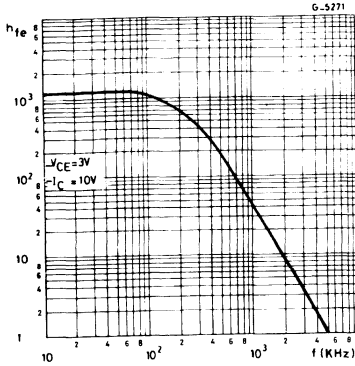

Capacitances (NPN types).

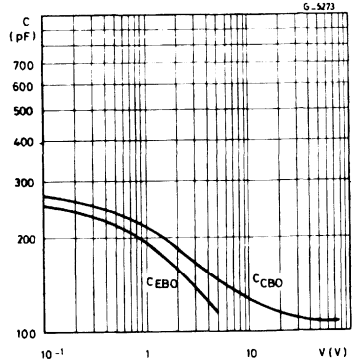

Capacitances (PNP types).

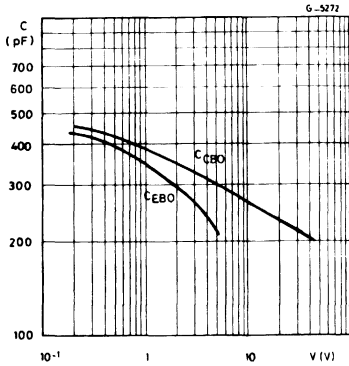

Saturated Switching Times (NPN types).

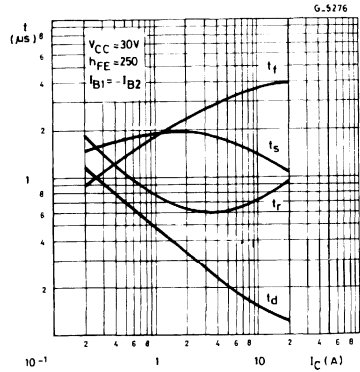

Saturated Switching Times (PNP types).

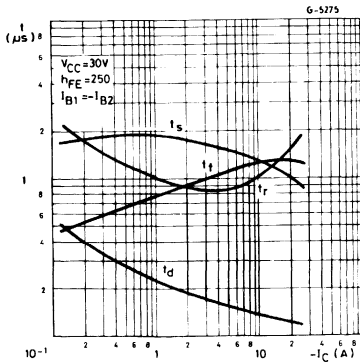

POWER DARLINGTON TRANSISTORS

DESCRIPTION

The 2N6386, 2N6387 and 2N6388 are silicon epitaxial-base NPN transistors in monolithic Darlington configuration and are mounted in Jedec TO-220 plastic package.

They are intended for use in low and medium frequency power applications.

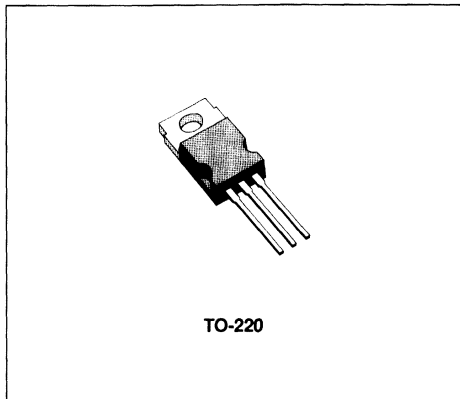

INTERNAL SCHEMATIC DIAGRAM

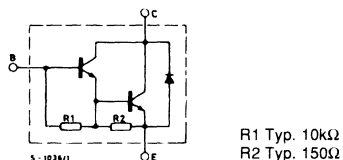

ABSOLUTE MAXIMUM RATINGS

Symbol	Parameter	2N6386	2N6387	2N6388	Unit
V_{CBO}	Collector-base Voltage ($I_B = 0$)	40	60	80	V
V_{CEV}	Collector-emitter Voltage ($V_{BE} = -1.5V$)	40	60	80	V
V_{CER}	Collector-emitter Voltage ($R_{BE} \leq 100\Omega$)	40	60	80	V
V_{CEO}	Collector-emitter Voltage ($I_B = 0$)	40	60	80	V
V_{EBO}	Emitter-base Voltage ($I_C = 0$)	5	5	5	V
I_C	Collector Current	8	10	10	A
I_{CM}	Collector Peak Current	15			A
I_B	Base Current	250			mA
P_{tot}	Total Power Dissipation at $T_{case} \leq 25^\circ C$	65			W
T_{stg}	Storage Temperature	- 65 to 150			$^\circ C$
T_j	Junction Temperature	150			$^\circ C$

THERMAL DATA

$R_{th\ j-case}$	Thermal Resistance Junction-case	Max	1.92	°C/W
------------------	----------------------------------	-----	------	------

ELECTRICAL CHARACTERISTICS ($T_{case} = 25^{\circ}C$ unless otherwise specified)

Symbol	Parameter	Test Conditions	Min.	Typ.	Max.	Unit
I_{CEV}	Collector Cutoff Current ($V_{BE} = -1.5V$)	$V_{CE} = 40V$ for 2N6386 $V_{CE} = 60V$ for 2N6387 $V_{CE} = 80V$ for 2N6388 $T_{case} = 125^{\circ}C$ $V_{CE} = 40V$ for 2N6386 $V_{CE} = 60V$ for 2N6387 $V_{CE} = 80V$ for 2N6388			0.3 0.3 0.3 3 3 3	mA mA mA mA mA mA
I_{CEO}	Collector Cutoff Current ($I_B = 0$)	$V_{CE} = 40V$ for 2N6386 $V_{CE} = 60V$ for 2N6387 $V_{CE} = 80V$ for 2N6388			1 1 1	mA mA mA
I_{EBO}	Emitter-base Current ($I_C = 0$)	$V_{EB} = 5V$			5	mA
$V_{CEQ(sus)}^*$	Collector-emitter Sustaining Voltage ($I_B = 0$)	$I_C = 200mA$ for 2N6386 for 2N6387 for 2N6388	40 60 80			V V V
$V_{CER(sus)}^*$	Collector-emitter Sustaining Voltage ($R_{BE} = 100\Omega$)	$I_C = 200mA$ for 2N6386 for 2N6387 for 2N6388	40 60 80			V V V
$V_{CEV(sus)}^*$	Collector-emitter Sustaining Voltage ($V_{BE} = -1.5V$)	$I_C = 200mA$ for 2N6386 for 2N6387 for 2N6388	40 60 80			V V V
$V_{CE(sat)}^*$	Collector-emitter Saturation Voltage	for 2N6386 $I_C = 3A$ $I_B = 6mA$ for 2N6387 and 2N6388 $I_C = 5A$ $I_B = 10mA$ for 2N6386 $I_C = 8A$ $I_B = 80mA$ for 2N6387 and 2N6388 $I_C = 10A$ $I_B = 100mA$			2 2 3 3	V V V V
V_{BE}^*	Base-emitter Voltage	for 2N6386 $I_C = 3A$ $V_{CE} = 3V$ for 2N6387 and 2N6388 $I_C = 5A$ $V_{CE} = 3V$ for 2N6386 $I_C = 8A$ $V_{CE} = 3V$ for 2N6387 and 2N6388 $I_C = 10A$ $V_{CE} = 3V$			2.8 2.8 4.5 4.5	V V V V
h_{FE}^*	DC Current Gain	for 2N6386 $I_C = 3A$ $V_{CE} = 3V$ for 2N6387 and 2N6388 $I_C = 5A$ $V_{CE} = 3V$ for 2N6386 $I_C = 8A$ $V_{CE} = 3V$ for 2N6387 and 2N6388 $I_C = 10A$ $V_{CE} = 3V$	1000 1000 100 100		20000 20000	

* Pulsed : pulse duration = 300µs, duty cycle = 1.5%.

ELECTRICAL CHARACTERISTICS (continued)

Symbol	Parameter	Test Conditions	Min.	Typ.	Max.	Unit
h_{fe}	Small Signal Current Gain	$I_C = 1A$ $V_{CE} = 10V$ $f = 1MHz$ $V_{CE} = 10V$ $f = 1KHz$	20 1000			
V_F^*	Paralleled-diode Forward Voltage	for 2N6386 $I_F = 8A$ for 2N6387 and 2N6388 $I_F = 10A$			4 4	V V
C_{CBO}	Collector-base Capacitance	$I_E = 0$ $V_{CB} = 10V$ $f = 1MHz$			200	pF
$I_{s/b}^{**}$	Second Breakdown Collector Current	$V_{CE} = 25V$	2.6			A
$E_{s/b}$	Second Breakdown Energy	$L = 12mH$ $R_{BE} = 100\Omega$ $V_{BE} = -1.5V$ $I_C = 4.5A$	120			mJ

* Pulsed : pulse duration = 300 μ s, duty cycle = 1.5%.

** Pulsed : 1s non repetitive pulse.

For characteristic curves see BDX33/BDX34 series.

POWER LINEAR AND SWITCHING APPLICATIONS

DESCRIPTION

The 2N6486, 2N6487 and 2N6488 are silicon epitaxial-base NPN transistors mounted in Jedec TO-220 plastic package.

They are intended for use in power linear and switching applications.

The complementary PNP types are the 2N6489, 2N6490 and 2N6491 respectively.

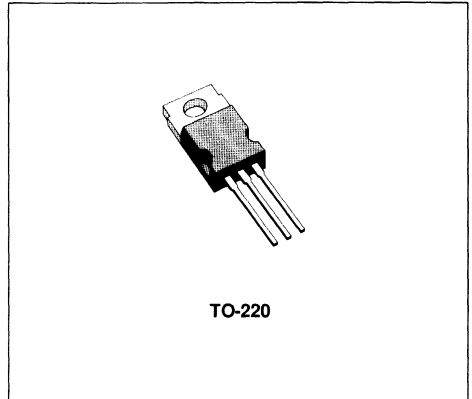

INTERNAL SCHEMATIC DIAGRAMS

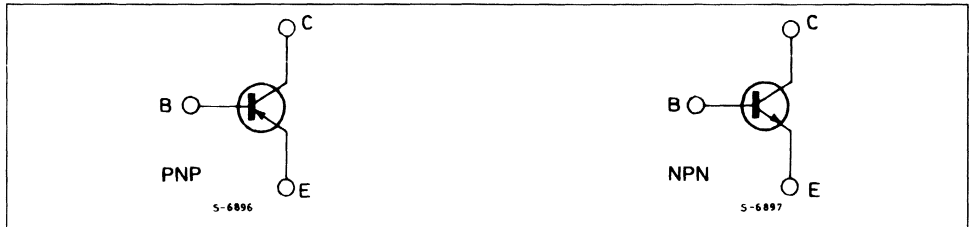

ABSOLUTE MAXIMUM RATINGS

Symbol	Parameter	NPN	2N6486	2N6487	2N6488	Unit
		PNP*	2N6489	2N6490	2N6491	
V_{CBO}	Collector-base Voltage ($I_E = 0$)		50	70	90	V
V_{CEX}	Collector-base Voltage ($V_{BE} = 1.5V$; $R_{BE} = 100\Omega$)		50	70	90	V
V_{CEO}	Collector-base Voltage ($I_B = 0$)		40	60	80	V
V_{EBO}	Emitter-base Voltage ($I_C = 0$)		5			V
I_C	Collector Current		15			A
I_B	Base-current		5			A
P_{tot}	Total Power Dissipation at $T_{case} \leq 25^\circ C$ $T_{case} \leq 25^\circ C$		75			W
			1.8			W
T_{stg}	Storage Temperature		- 65 to 150			$^\circ C$
T_J	Junction Temperature		150			$^\circ C$

* For NPN types voltage and current values are negative.

THERMAL DATA

R _{th j-case}	Thermal Resistance Junction-case	Max	1.67	°C/W
R _{th j-amb}	Thermal Resistance Junction-ambient	Max	70	°C/W

ELECTRICAL CHARACTERISTICS (T_{case} = 25°C unless otherwise specified)

Symbol	Parameter	Test Conditions	Min.	Typ.	Max.	Unit
I _{CEO}	Collector-cutoff Current (I _B = 0)	for 2N6486/89 V _{CE} = 20V for 2N6487/90 V _{CE} = 30V for 2N6488/91 V _{CE} = 40V			1 1 1	mA mA mA
I _{CEX}	Collector-cutoff Current (V _{BE} = -1.5V, R _{BE} = 100 Ω)	for 2N6486/89 V _{CE} = 45V for 2N6487/90 V _{CE} = 65V for 2N6488/91 V _{CE} = 85V T _{case} = 150°C for 2N6486/89 V _{CE} = 40V for 2N6487/90 V _{CE} = 60V for 2N6488/91 V _{CE} = 80V			0.5 0.5 0.5 5 5 5	mA mA mA mA mA mA
I _{CER}	Collector-cutoff Current (R _{BE} = 100Ω)	for 2N6486/89 V _{CE} = 35V for 2N6487/90 V _{CE} = 55V for 2N6488/91 V _{CE} = 75V			0.5 0.5 0.5	mA mA mA
I _{EBO}	Emitter-cutoff Current (I _C = 0)	V _{EB} = 5V			1	mA
V _{CEO(sus)*}	Collector-emitter Sustaining Voltage (I _B = 0)	I _C = 200mA for 2N6486/89 for 2N6487/90 for 2N6488/91	40 60 80			V V V
V _{CER(sus)*}	Collector-emitter Sustaining Voltage (R _{BE} = 100Ω)	I _C = 200mA for 2N6486/89 for 2N6487/90 for 2N6488/91	45 65 85			V V V
V _{CEx(sus)*}	Collector-emitter Sustaining Voltage (V _{BE} = -1.5V, R _{BE} = 100Ω)	I _C = 200mA for 2N6486/89 for 2N6487/90 for 2N6488/91	50 70 90			V V V
V _{CE(sat)*}	Collector-emitter Saturation Voltage	I _C = 5A I _B = 0.5A I _C = 15A I _B = 5A			1.3 3.5	V V
V _{BE*}	Base-emitter Voltage	I _C = 5A V _{CE} = 4V I _C = 15A V _{CE} = 4V			1.3 3.5	V V
h _{FE*}	DC Current Gain	I _C = 5A V _{CE} = 4V I _C = 15A V _{CE} = 4V	20 5		150	
h _{re}	Small Signal Current Gain	I _C = 1A V _{CE} = 4V f = 1MHz I _C = 1A V _{CE} = 4V f = 1KHz	5 25			

* Pulsed : pulse duration = 300µs, duty cycle ≤ 2%.
For PNP types voltage and current values are negative.

HIGH VOLTAGE POWER SWITCH

DESCRIPTION

The 2N6497/98/99 are silicon multiepitaxial mesa NPN transistors in Jedec TO-220 plastic package particularly intended for switch-mode applications.

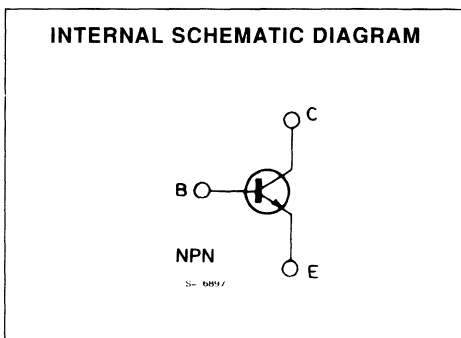
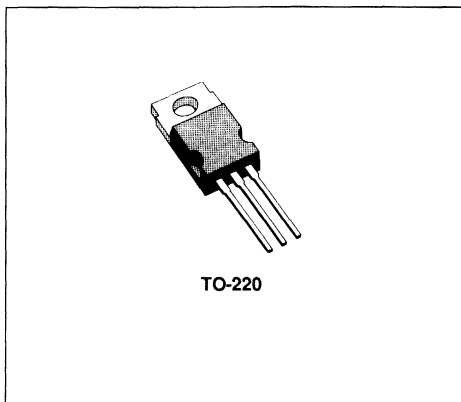

ABSOLUTE MAXIMUM RATINGS

Symbol	Parameter	2N6497	2N6498	2N6499	Unit
V_{CBO}	Collector-base Voltage ($I_E = 0$)	350	400	450	V
V_{CEO}	Collector-emitter Voltage ($I_B = 0$)	250	300	350	V
V_{EBO}	Emitter-base Voltage ($I_C = 0$)	6			V
I_C	Collector Current	5			A
I_{CM}	Collector Peak Current	10			A
I_B	Base Current	2			A
P_{tot}	Total Power Dissipation at $T_{case} \leq 25^\circ\text{C}$	80			W
T_{stg}	Storage Temperature	- 65 to 150			$^\circ\text{C}$
T_j	Junction Temperature	150			$^\circ\text{C}$

THERMAL DATA

$R_{th(j-case)}$	Thermal Resistance Junction-case	Max	1.56	°C/W
------------------	----------------------------------	-----	------	------

ELECTRICAL CHARACTERISTICS ($T_{case} = 25^{\circ}C$ unless otherwise specified)

Symbol	Parameter	Test Conditions	Min.	Typ.	Max.	Unit
I_{CEV}	Collector-cutoff Current ($V_{BE} = -1.5V$)	for 2N6497 $V_{CE} = 350V$ $V_{CE} = 175V$ for 2N6498 $V_{CE} = 400V$ $V_{CE} = 200V$ for 2N6499 $V_{CE} = 450V$ $V_{CE} = 225V$	$T_{case} = 100^{\circ}C$		1	mA
				10	mA	
				1	mA	
				10	mA	
				1	mA	
			10	mA		
I_{EBO}	Emitter Cutoff Current ($I_C = 0$)	$V_{EB} = 6V$			1	mA
$V_{CEO(sus)}$	Collector-emitter Sustaining Voltage ($I_B = 0$)	$I_C = 25mA$	for 2N6497 for 2N6498 for 2N6499	250 300 350		V V V
h_{FE}^*	DC Current Gain	$I_C = 2.5A$ $I_C = 5A$	$V_{CE} = 10V$ $V_{CE} = 10V$	10 3	75	
$V_{CE(sat)}^*$	Collector-emitter Saturation Voltage	$I_C = 2.5A$	$I_B = 0.5A$ for 2N6497 for 2N6498 for 2N6499		1 1.25 1.5	V V V
		$I_C = 5A$	$I_B = 2A$ all types		5	V
t_{on}	Turn-on Time	$I_C = 2.5A$ $I_{B2} = -1A$	$I_{B1} = 0.5A$ $V_{CC} = 125V$		0.8	μs
t_s	Storage Time	$I_C = 2.5A$ $I_{B2} = -1A$	$I_{B1} = 0.5A$ $V_{CC} = 125V$		1.8	μs
t_f	Fall Time	$I_C = 2.5A$ $I_{B2} = -1A$	$I_{B1} = 0.5A$ $V_{CC} = 125V$		0.8	μs

* Pulsed : pulse duration = 300 μs , duty cycle = 1.5%.

Safe Operating Areas.

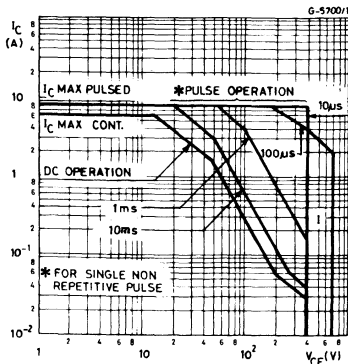

!-Area of permissible operation during turn-on provided $R_{BE} \le 100\Omega$ and $t_p \le 0.25\mu s$.

DC Current Gain.

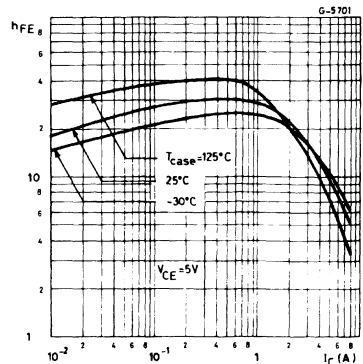

Collector-emitter Saturation Voltage

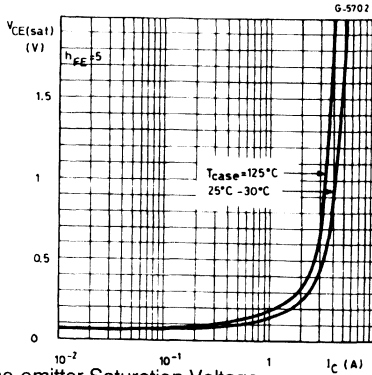

Collector-emitter Saturation Voltage.

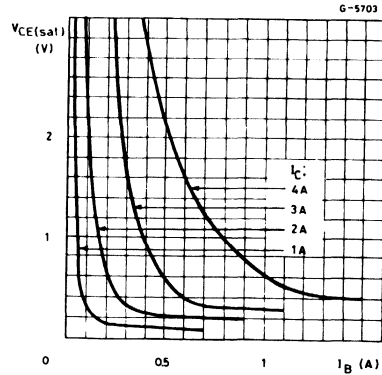

Base-emitter Saturation Voltage.

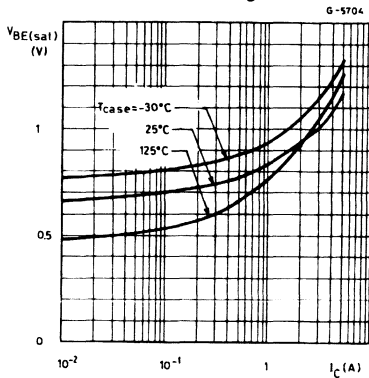

Saturated Switching Characteristics.

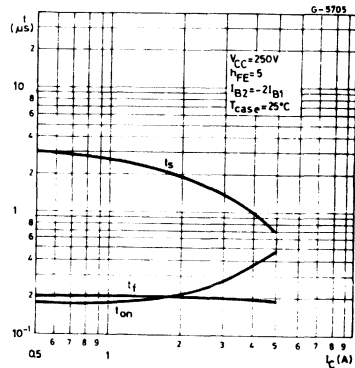

Saturated Switching Characteristics.

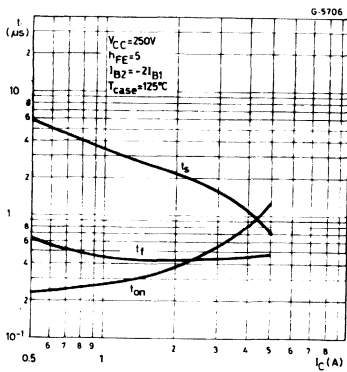

Saturated Swit-

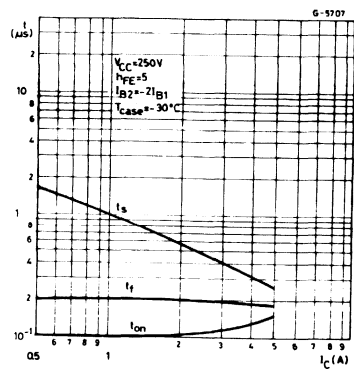

Clamped Reverse bias Safe Operating Areas.

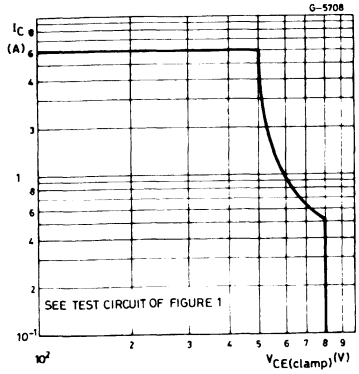
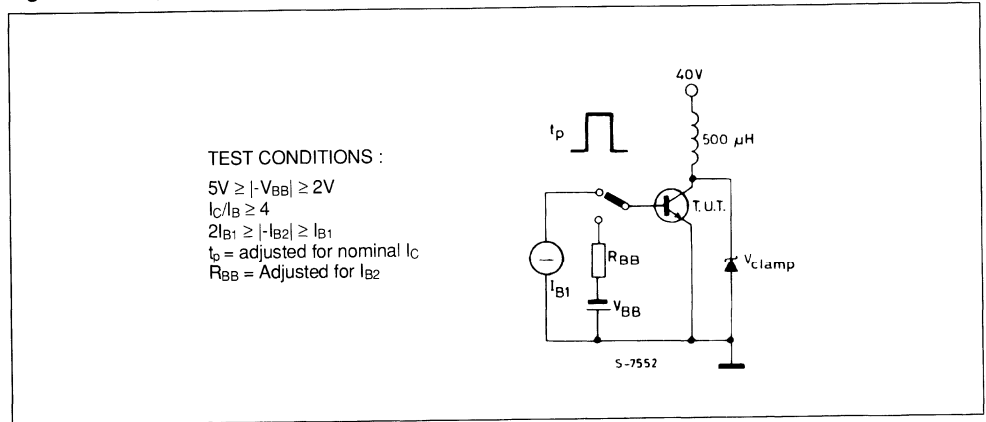

Figure 1 : Clamped Es/b Test Circuit.



HIGH VOLTAGE POWER SWITCH

DESCRIPTION

The 2N6544 and 2N6545 are multi-epitaxial mesa NPN transistors in Jedec TO-3 metal case. They are intended for high voltage, fast switching applications.

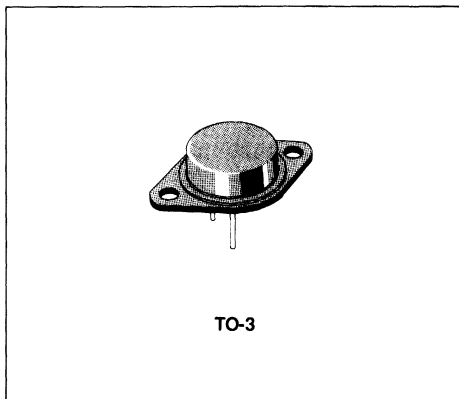

INTERNAL SCHEMATIC DIAGRAM

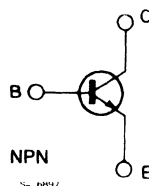

ABSOLUTE MAXIMUM RATINGS

Symbol	Parameter	2N6544	2N6545	Unit
V_{CES}	Collector-emitter Voltage ($V_{BE} = 0$)	650	850	V
V_{GEX}	(clamped) Collector-emitter Voltage ($V_{BE} = -5V$)	350	450	V
V_{CEO}	Collector-emitter Voltage ($I_B = 0$)	300	400	V
V_{EBO}	Emitter-base Voltage ($I_C = 0$)	9		V
I_C	Collector Current	8		A
I_{CM}	Collector Peak Current ($t_p = 10ms$)	16		A
I_B	Base Current	8		A
P_{tot}	Total Power Dissipation at $T_{case} \leq 25^\circ C$	125		W
T_{stg}	Storage Temperature	- 65 to 200		$^\circ C$
T_j	Junction Temperature	200		$^\circ C$

THERMAL DATA

$R_{th\ j-case}$	Thermal Resistance Junction-case	Max	1.4	$^{\circ}C/W$
------------------	----------------------------------	-----	-----	---------------

ELECTRICAL CHARACTERISTICS ($T_{case} = 25^{\circ}C$ unless otherwise specified)

Symbol	Parameter	Test Conditions	Min.	Typ.	Max.	Unit
I_{CES}	Collector Cutoff Current ($V_{BE} = 0$)	for 2N6544 $V_{CE} = 650V$ for 2N6545 $V_{CE} = 850V$ $T_{case} = 100^{\circ}C$ for 2N6544 $V_{CE} = 650V$ for 2N6545 $V_{CE} = 850V$			0.5 0.5 2.5 2.5	 mA mA mA mA
I_{CER}	Collector Cutoff Current ($R_{BE} = 50\Omega$)	$T_{case} = 100^{\circ}C$ for 2N6544 $V_{CE} = 650V$ for 2N6545 $V_{CE} = 850V$			3 3	 mA mA
I_{EBO}	Emitter Cutoff Current ($I_C = 0$)	$V_{EB} = 9V$			1	 mA
$V_{CEO(sus)}^*$	Collector-emitter Sustaining Voltage ($I_B = 0$)	$I_C = 100mA$ for 2N6544 for 2N6545	300 400			 V V
$V_{CEX(sus)}$	Collector-emitter Sustaining Voltage (clamped $E_{s/b}$)	$I_C/I_B = 5$ $L = 180\mu H$ $V_{BE} = -5V$ $T_{case} = 100^{\circ}C$ $V_{clamp} = \text{rated } V_{CEX(sus)}$ $I_C = 4.5A$ for 2N6544 for 2N6545 $V_{clamp} = \text{rated } V_{CEO(sus)} - 100V$ $I_C = 8A$ for 2N6544 for 2N6545	350 450 200 300			 V V V V
$I_{s/b}$	Second Breakdown Collector Current	$t = 1s$ (non repetitive) $V_{CE} = 100V$	0.2			 A
$E_{s/b}$	Second Breakdown Energy	$L = 40\mu H$ $V_{BE} = -4V$ $R_{BE} = 50\Omega$	500			 μJ
h_{FE}^*	DC Current Gain	$I_C = 2.5A$ $V_{CE} = 3V$ $I_C = 5A$ $V_{CE} = 3V$	12 7		60 35	
$V_{CE(sat)}^*$	Collector-emitter Saturation Voltage	$I_C = 5A$ $I_B = 1A$ $I_C = 8A$ $I_B = 2A$ $T_{case} = 100^{\circ}C$ $I_C = 5A$ $I_B = 1A$			1.5 5 2.5	 V V V
$V_{BE(sat)}^*$	Base-emitter Saturation Voltage	$I_C = 5A$ $I_B = 1A$ $T_{case} = 100^{\circ}C$ $I_C = 5A$ $I_B = 1A$			1.6 1.6	 V V
f_T	Transistion Frequency	$I_C = 0.3A$ $V_{CE} = 10V$ $f = 1MHz$	6		24	 MHz
C_{CBO}	Collector-base Capacitance	$V_{CB} = 10V$ $I_E = 0$ $f = 1MHz$			200	 pF

ELECTRICAL CHARACTERISTICS (continued)

Symbol	Parameter	Test Conditions	Min.	Typ.	Max.	Unit
t_{on}	Turn-on Time	RESISTIVE LOAD $I_C = 5A$ $V_{CC} = 250V$ $I_{B1} = - I_{B2} = 1A$			1	μS
t_s	Storage Time				4	μS
t_f	Fall Time				1	μS
t_s	Storage Time	INDUCTIVE LOAD $I_C = 5A(pk)$ $I_{B1} = 1A$ $V_{BE} = -5V$ $L = 180\mu H$ $T_{case} = 100^\circ C$ for 2N6544 $V_{clamp} = 350V$ for 2N6545 $V_{clamp} = 450V$			4	μS
t_f	Fall Time				0.9	μS

* Pulsed : pulse duration = 300 μs , duty cycle = 1.5%.
For characteristic curves see the BUX47 type.

NPN HIGH VOLTAGE POWER TRANSISTORS

- SWITCHING REGULATORS
- INVERTERS
- SOLENOID AND RELAY DRIVERS
- MOTOR CONTROLS
- DEFLECTION CIRCUITS

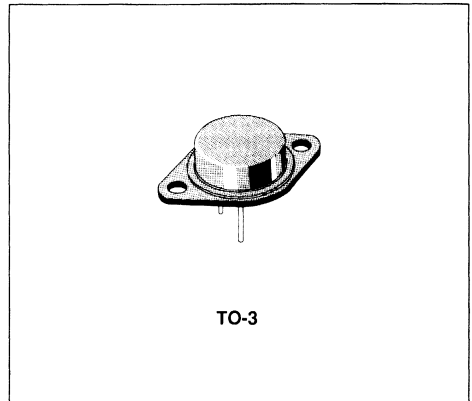

INTERNAL SCHEMATIC DIAGRAM

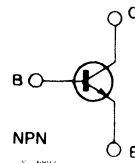

DESCRIPTION

High voltage, high speed switching power transistors suited for use on the 220 and 380V mains.

ABSOLUTE MAXIMUM RATINGS

Symbol	Parameter	2N6671	2N6672	2N6673	Unit
V_{CEV}	Collector-emitter Voltage ($V_{BE} = -1.5V$)	450	550	650	V
V_{CEX}	Collector-emitter Voltage	350	400	450	V
V_{CEO}	Collector-emitter Voltage ($I_B = 0$)	300	350	400	V
V_{EBO}	Emitter-base Voltage ($I_C = 0$)	8			V
I_C	Collector Current	8			A
I_{CM}	Collector Peak Current	10			A
I_B	Base Current	4			A
P_{Tot}	Total Dissipation at $T_C < 25^\circ C$	150			W
T_{stg}	Storage Temperature	- 65 to 200			$^\circ C$
T_j	Max. Operating Junction Temperature	200			$^\circ C$

THERMAL DATA

$R_{thj-case}$	Thermal Resistance Junction-case	Max	1.17	°C/W
----------------	----------------------------------	-----	------	------

ELECTRICAL CHARACTERISTICS ($T_{case} = 25^{\circ}C$ unless otherwise specified)

Symbol	Parameter	Test Conditions		Min.	Typ.	Max.	Unit
I_{CEV}	Collector Cutoff Current	$V_{CE} = V_{CEV}$ $V_{BE} = -1.5V$				0.1 1	mA mA
I_{EBO}	Emitter Cutoff Current ($I_C = 0$)	$V_{EB} = 8V$				2	mA
$V_{CE(sus)}^*$	Collector Emitter Sustaining Voltage	$I_C = 0.2A$	$L_C = 25mH$ for 2N6671 for 2N6672 for 2N6673	300 350 400			V V V
$V_{CE(clamp)}$	Collector Emitter Clamped Voltage	$V_{BB} = -5V$ $R_{BB} = 5\Omega$ $I_C = 5A$	$L_C = 170\mu H$ $I_{B1} = -I_{B2} = 1A$ for 2N6671 for 2N6672 for 2N6673	350 400 450			V V V
		$I_C = 8A$	$I_{B1} = -I_{B2} = 3A$ for 2N6671 for 2N6672 for 2N6673	200 250 300			V V V
$V_{CE(sat)}^*$	Collector-emitter Saturation Voltage	$I_C = 5A$ $I_C = 5A$ $I_C = 8A$	$I_B = 1A$ $I_B = 1A$ $I_B = 4A$ $T_c = 100^{\circ}C$			1 2 2	V V V
$V_{BE(sat)}^*$	Base-emitter Saturation Voltage	$I_C = 5A$	$I_B = 1A$			1.6	V
h_{FE}^*	DC Current Gain	$I_C = 5A$	$V_{CE} = 3V$	10		40	
h_{fe}	Small Signal Current Gain	$I_C = 0.2A$	$V_{CE} = 10V$ $f = 1MHz$	3		12	

RESISTIVE LOAD

Symbol	Parameter	Test Conditions		Min.	Typ.	Max.	Unit
t_d	Delay Time	$V_{CC} = 125V$	$I_C = 5A$ $t_p = 20\mu s$			0.1	μs
t_r	Rise Time	$V_{BB} = -6V$	$I_{B1} = 1A$			0.5	μs
t_r	Rise Time	$V_{CC} = 125V$ $V_{BB} = -6V$	$I_C = 5A$ $I_{B1} = 1A$ $T_c = 125^{\circ}C$			0.8	μs
t_s	Storage Time	$V_{CC} = 125V$	$I_C = 5A$ $t_p = 20\mu s$			2.5	μs
t_f	Fall Time	$V_{BB} = -6V$	$I_{B1} = -I_{B2} = 1A$			0.4	μs
t_s	Storage Time	$V_{CC} = 125V$	$I_C = 5A$ $t_p = 20\mu s$			4	μs
t_f	Fall Time	$V_{BB} = -6V$ $T_c = 100^{\circ}C$	$I_{B1} = -I_{B2} = 1A$			0.8	μs

Figure 1 : Test Circuit RBSOA.

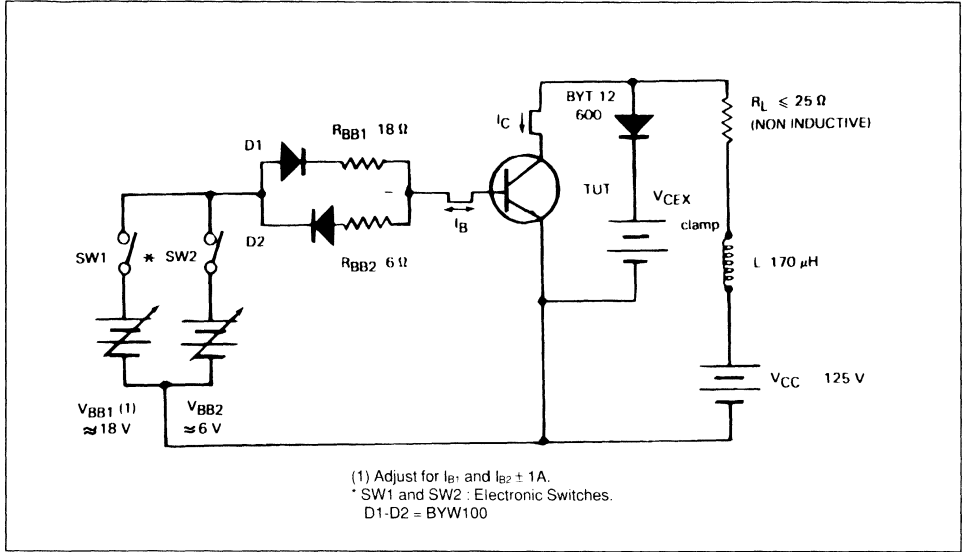
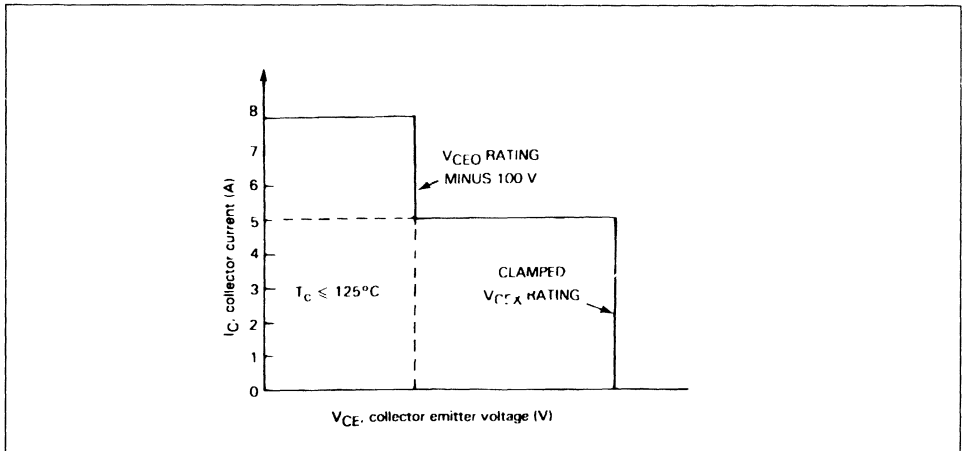
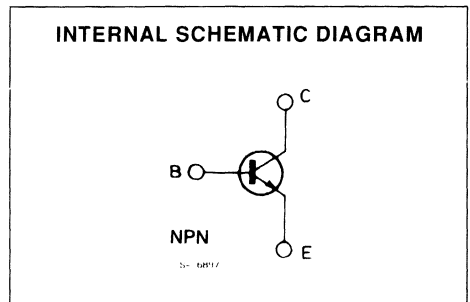
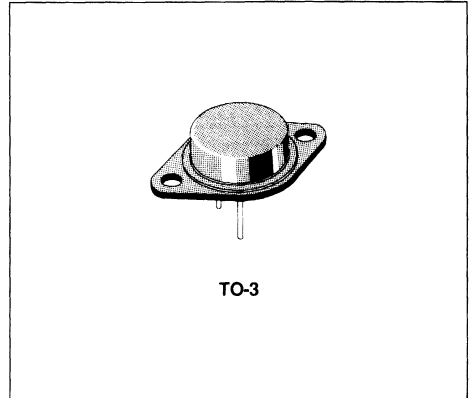

Figure 2 : Maximum Operating Conditions for Switching between Saturation and Cut-off.



NPN HIGH VOLTAGE POWER TRANSISTORS

- SWITCHING REGULATORS
- INVERTERS
- SOLENOID AND RELAY DRIVERS
- MOTOR CONTROLS
- DEFLECTION CIRCUITS



DESCRIPTION

High voltage, high speed switching power transistors suited for use on the 220 and 380V mains.

ABSOLUTE MAXIMUM RATINGS

Symbol	Parameter	2N6674	2N6675	Unit
V_{CEV}	Collector-emitter Voltage ($V_{BE} = -1.5V$)	450	650	V
V_{CEX}	Collector-emitter Voltage	350	400	V
V_{CEO}	Collector-emitter Voltage ($I_B = 0$)	300	450	V
V_{EBO}	Emitter-base Voltage ($I_C = 0$)	7		V
I_C	Collector Current	15		A
I_{CM}	Collector Peak Current	20		A
I_B	Base Current	5		A
P_{tot}	Total Dissipation at $T_c < 25^\circ C$	175		W
T_{stg}	Storage Temperature	- 65 to 200		$^\circ C$
T_j	Max. Operating Junction Temperature	200		$^\circ C$

THERMAL DATA

$R_{thj-case}$	Thermal Resistance Junction-case	Max	1	°C/W
----------------	----------------------------------	-----	---	------

ELECTRICAL CHARACTERISTICS ($T_{case} = 25^{\circ}C$ unless otherwise specified)

Symbol	Parameter	Test Conditions	Min.	Typ.	Max.	Unit
I_{CEV}	Collector Cutoff Current	$V_{CE} = V_{CEV}$ $V_{BE} = -1.5V$ $V_{CE} = V_{CEV}$ $V_{BE} = -1.5V$ $T_c = 100^{\circ}C$			0.1 1	mA mA
I_{EBO}	Emitter Cutoff Current ($I_C = 0$)	$V_{EB} = 7V$			2	mA
$V_{CEO(sus)}^*$	Collector Emitter Sustaining Voltage	$I_C = 0.2A$ $L_C = 25mH$ for 2N6674 for 2N6675	300 400			V V
$V_{CEX(sus)}^*$	Collector-emitter Sustaining Voltage	$I_C = 10A$ $L_C = 50\mu H$ $I_B = 2A$ $R_{BB} = 2\Omega$ $V_{BB} = -4V$ for 2N6674 for 2N6675	350 450			V V
$V_{CE(sat)}^*$	Collector-emitter Saturation Voltage	$I_C = 10A$ $I_B = 2A$ $I_C = 10A$ $I_B = 2A$ $T_c = 100^{\circ}C$ $I_C = 15A$ $I_B = 5A$			1 2 5	V V V
$V_{BE(sat)}^*$	Base-emitter Saturation Voltage	$I_C = 10A$ $I_B = 2A$			1.5	V
h_{FE}^*	DC Current Gain	$I_C = 10A$ $V_{CE} = 2V$	8			
h_{fe}	Small Signal Current Gain	$I_C = 1A$ $V_{CE} = 10V$ $f = 5MHz$	3		10	

RESISTIVE LOAD

Symbol	Parameter	Test Conditions	Min.	Typ.	Max.	Unit
t_d	Delay Time	$V_{CC} = 135V$ $I_C = 10A$ $t_p = 20\mu s$			0.1	μs
t_r	Rise Time	$V_{BB} = -6V$ $I_{r\#} p = 20\mu s$			0.6	μs
t_r	Rise Time	$V_{CC} = 135V$ $I_C = 10A$ $t_p = 20\mu s$ $V_{BB} = -6V$ $I_{B1} = 2A$ $T_c = 100^{\circ}C$			1	μs
t_s	Storage Time	$V_{CC} = 135V$ $I_C = 10A$ $t_p = 20\mu s$			2.5	μs
t_f	Fall Time	$V_{BB} = -6V$ $I_{B1} = -I_{B2} = 2A$			0.5	μs
t_s	Storage Time	$V_{CC} = 135V$ $I_C = 10A$ $t_p = 20\mu s$			4	μs
t_f	Fall Time	$V_{BB} = -6V$ $I_{B1} = -I_{B2} = 2A$ $T_c = 100^{\circ}C$			1	μs

INDUCTIVE LOAD

Symbol	Parameter	Test Conditions	Min.	Typ.	Max.	Unit
t_c	Crossover Time	$V_{CC} = 135V$ $I_C = 10A$ $L_C = 50\mu H$ $R_C = 13.5\Omega$ $I_{B1} = -I_{B2} = 2A$ $V_{clamp} = V_{CEX}$ $T_c = 25^{\circ}C$ $T_c = 100^{\circ}C$			0.5 0.8	μs μs

* Pulsed : Pulse duration = 300 μs , duty cycle = 2 %.

Figure 1 : Test Circuit RBSOA.

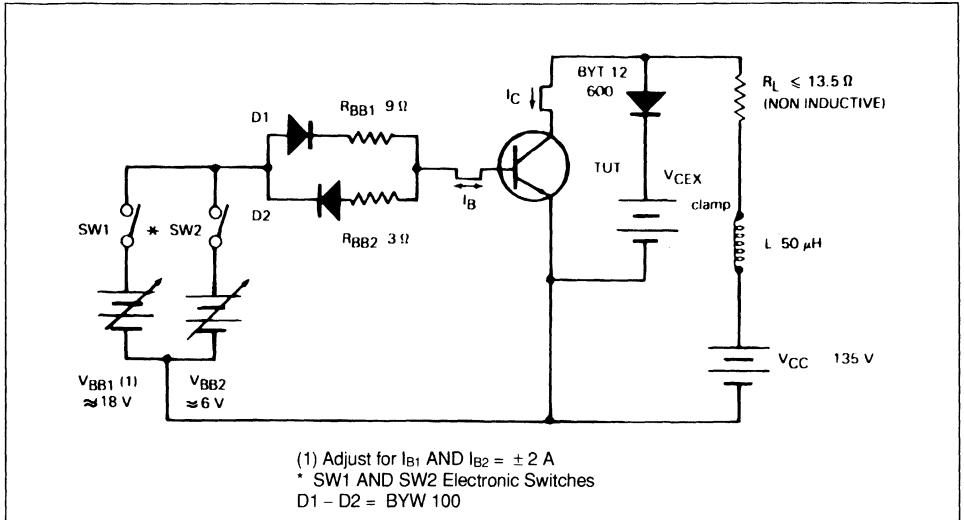
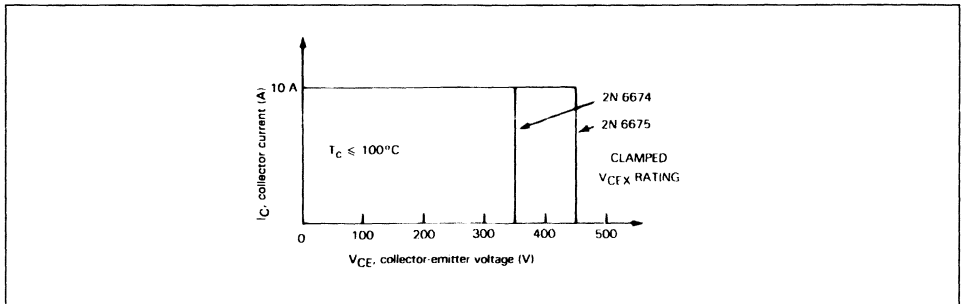
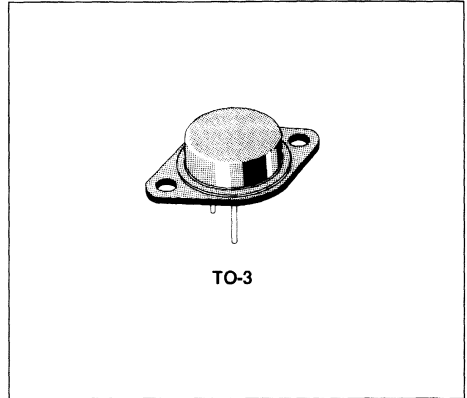

Figure 2 : Maximum Operating Conditions for Switching between Saturation and Cut-off.



NPN HIGH VOLTAGE POWER TRANSISTORS

- SWITCHING REGULATORS
- INVERTERS
- SOLENOID AND RELAY DRIVERS
- MOTOR CONTROLS
- DEFLECTION CIRCUITS



INTERNAL SCHEMATIC DIAGRAM

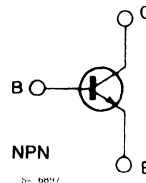

DESCRIPTION

High voltage, high speed switching power transistors suited for use on the 220 and 380 V mains.

ABSOLUTE MAXIMUM RATINGS

Symbol	Parameter	2N6676	2N6677	2N6678	Unit
V_{CEV}	Collector-emitter Voltage ($V_{BE} = -1.5V$)	450	550	650	V
V_{CEX}	Collector-emitter Voltage	350	400	450	V
V_{CEO}	Collector-emitter Voltage ($I_B = 0$)	300	350	400	V
V_{EBO}	Emitter-base Voltage ($I_C = 0$)	8			V
I_C	Collector Current	15			A
I_{CM}	Collector Peak Current	20			A
I_B	Base Current	5			A
P_{tot}	Total Dissipation at $T_C < 25^\circ C$	175			W
T_{stg}	Storage Temperature	- 65 to 200			$^\circ C$
T_J	Max. Operating Junction Temperature	200			$^\circ C$

THERMAL DATA

$R_{thj-case}$	Thermal Resistance Junction-case	Max	1	°C/W
----------------	----------------------------------	-----	---	------

ELECTRICAL CHARACTERISTICS ($T_{case} = 25^{\circ}C$ unless otherwise specified)

Symbol	Parameter	Test Conditions	Min.	Typ.	Max.	Unit
I_{CEV}	Collector Cutoff Current	$V_{CE} = V_{CEV}$ $V_{BE} = -1.5V$ $V_{CE} = V_{CEV}$ $V_{BE} = -1.5V$ $T_c = 100^{\circ}C$			0.1 1	mA
I_{EBO}	Emitter Cutoff Current ($I_C = 0$)	$V_{EB} = 8V$			2	mA
$V_{CEO(sus)*}$	Collector Emitter Sustaining Voltage	$I_C = 0.2A$ $L_C = 25mH$ for 2N6676 for 2N6677 for 2N6678	300 350 400			V V V
$V_{CEX(sus)*}$	Collector Emitter Sustaining Voltage	$I_C = 15A$ $L_C = 50\mu H$ $I_B = 3A$ $R_{BB} = 2\Omega$ $V_{BB} = -6V$ for 2N6676 for 2N6677 for 2N6678	350 400 450			V V V
$V_{CE(sat)*}$	Collector-emitter Saturation Voltage	$I_C = 15A$ $I_B = 3A$ $I_C = 15A$ $I_B = 3A$ $T_c = 100^{\circ}C$			1 2	V
$V_{BE(sat)*}$	Base-emitter Saturation Voltage	$I_C = 15A$ $I_B = 3A$			1.5	V
h_{FE*}	DC Current Gain	$I_C = 15A$ $V_{CE} = 3V$	8			
h_{re}	Small Signal Current Gain	$I_C = 1A$ $V_{CE} = 10V$ $f = 5MHz$	3		10	

RESISTIVE LOAD

Symbol	Parameter	Test Conditions	Min.	Typ.	Max.	Unit
t_d	Delay Time	$V_{CC} = 200V$ $I_C = 15A$ $t_p = 20\mu s$			0.1	μs
t_r	Rise Time	$V_{BB} = -6V$ $I_{B1} = 3A$			0.6	μs
t_r	Rise Time	$V_{CC} = 200V$ $I_C = 15A$ $t_p = 20\mu s$ $V_{BB} = -6V$ $I_{B1} = 3A$ $T_c = 100^{\circ}C$			1	μs
t_s	Storage Time	$V_{CC} = 200V$ $I_C = 15A$ $t_p = 20\mu s$			2.5	μs
t_f	Fall Time	$V_{BB} = -6V$ $I_{B1} = -I_{B2} = 3A$			0.5	μs
t_s	Storage Time	$V_{CC} = 200V$ $I_C = 15A$ $t_p = 20\mu s$			4	μs
t_f	Fall Time	$V_{BB} = -6V$ $I_{B1} = -I_{B2} = 3A$ $T_c = 100^{\circ}C$			1	μs

INDUCTIVE LOAD

Symbol	Parameter	Test Conditions	Min.	Typ.	Max.	Unit
t_c	Crossover Time	$V_{CC} = 200V$ $I_C = 15A$ $L_C = 50\mu H$ $R_C = 13.5\Omega$ $I_{B1} = -I_{B2} = 3A$ $V_{clamp} = V_{CEX}$ $T_c = 25^{\circ}C$ $T_c = 100^{\circ}C$			0.5 0.8	μs μs

* Pulsed : pulse duration = 300 μs , duty cycle = 2%.

Figure 1 : Test Circuit RBSOA.

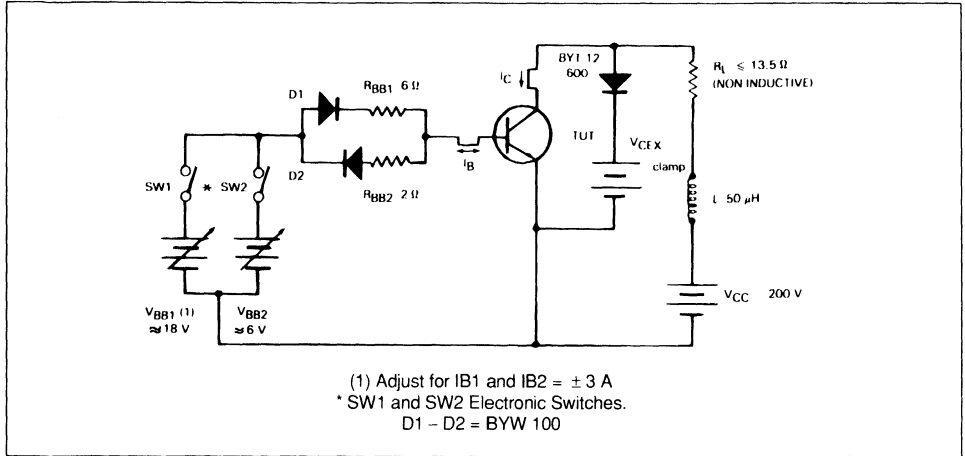
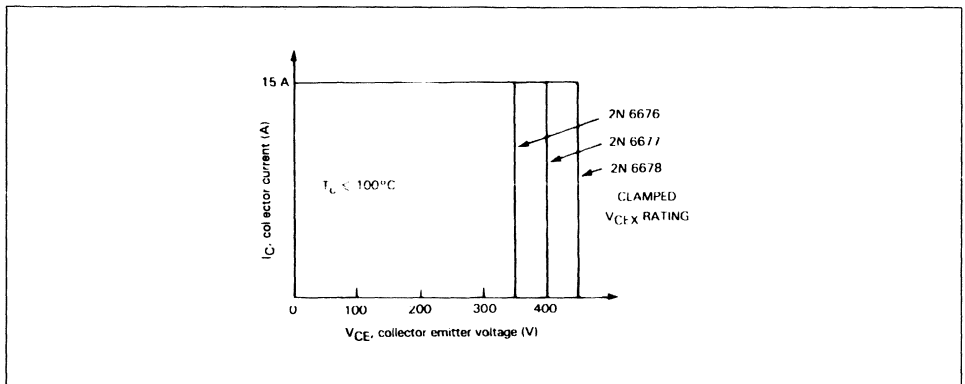

Figure 2 : Maximum Operating Conditions for Switching between Saturation and Cut-off.



SWITCHING AND GENERAL PURPOSE
DESCRIPTION

The 2N6702 is a silicon multi-epitaxial planar NPN transistor and is mounted in Jedec TO-220 plastic package.

It is intended for various switching and general purpose applications.

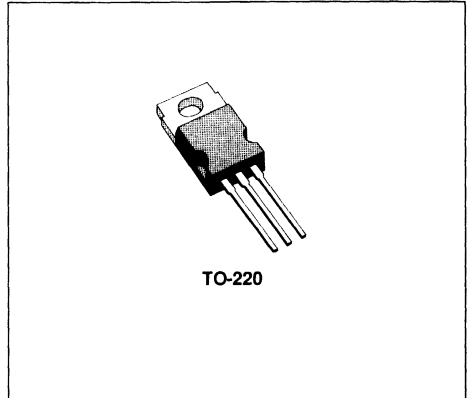
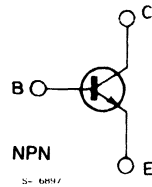
INTERNAL SCHEMATIC DIAGRAM

ABSOLUTE MAXIMUM RATINGS

Symbol	Parameter	Value	Unit
V_{CEV}	Collector-emitter Voltage ($V_{BE} = -1.5V$)	140	V
V_{CEO}	Collector-emitter Voltage ($I_B = 0$)	90	V
V_{EBO}	Emitter-base Voltage ($I_C = 0$)	7	V
I_C	Collector Current	7	A
I_{CM}	Collector Peak Current	10	A
I_B	Base Current	5	A
P_{tot}	Total Power Dissipation ($T_{case} \leq 25^\circ C$)	50	W
T_{stg}	Storage Temperature	- 65 to 150	$^\circ C$
T_j	Junction Temperature	150	$^\circ C$

THERMAL DATA

$R_{th(j-case)}$	Thermal Resistance Junction-case	Max	2.5	$^{\circ}\text{C/W}$
------------------	----------------------------------	-----	-----	----------------------

ELECTRICAL CHARACTERISTICS ($T_{case} = 25^{\circ}\text{C}$ unless otherwise specified)

Symbol	Parameter	Test Conditions	Min.	Typ.	Max.	Unit
I_{CEV}	Collector Cutoff Current ($V_{BE} = -1.5\text{V}$)	$V_{CE} = 140\text{V}$ $V_{CE} = 140\text{V}$ at $T_{case} = 125^{\circ}\text{C}$			100 1	μA mA
I_{EBO}	Emitter Cutoff Current ($I_C = 0$)	$V_{EB} = 7\text{V}$			100	μA
$V_{CEO(sus)}^*$	Collector-emitter Sustaining Voltage ($I_B = 0$)	$I_C = 100\text{mA}$	90			V
$V_{CE(sat)}^*$	Collector-emitter Saturation Voltage	$I_C = 5\text{A}$ $I_B = 0.5\text{A}$ $I_C = 7\text{A}$ $I_B = 0.7\text{A}$			0.8 1.5	V V
$V_{BE(sat)}^*$	Base-emitter Saturation Voltage	$I_C = 5\text{A}$ $I_B = 0.5\text{A}$			1.5	V
h_{FE}^*	DC Current Gain	$I_C = 0.2\text{A}$ $V_{CE} = 2\text{V}$ $I_C = 5\text{A}$ $V_{CE} = 2\text{V}$	30 20			
h_{fe}	Small Singal Current gain	$I_C = 0.5\text{A}$ $V_{CE} = 10\text{V}$ $f = 5\text{MHz}$	4		40	
f_T	Transistion Frequency	$I_C = 0.5\text{A}$ $V_C = 10\text{V}$ $f = 5\text{MHz}$	20		200	MHz
C_{CBO}	Collector Base Capacitance	$I_E = 0$ $V_{CB} = 10\text{V}$ $f = 100\text{KHz}$	50		150	pF
$I_{s/b}$	Second Breakdown	$V_{CE} = 20\text{V}$ $t = 100\text{ms}$	2.5			A
t_d	Delay Time	$I_C = 5\text{A}$ $I_{B1} = 0.5\text{A}$ $V_{CC} = 70\text{V}$			0.1	μs
t_r	Rise Time				0.25	μs
t_s	Storage Time	$I_C = 5\text{A}$ $I_{B1} = -I_{B2} = 0.5\text{A}$ $V_{CC} = 70\text{V}$			1	μs
t_f	Fall Time				0.5	μs

* Pulsed ; pulse duration = 300 μsec . ; duty cycle \leq 2%.

NPN HIGH VOLTAGE POWER TRANSISTORS

- OFF-LINE POWER SUPPLIES
- HIGH-VOLTAGE INVERTERS
- SWITCHING REGULATORS

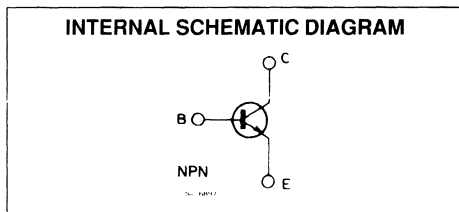
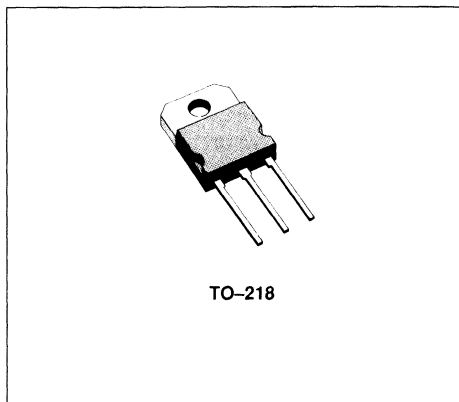

DESCRIPTION

High-voltage, high-speed, switching power transistors suited for use on medium voltage supply.

ABSOLUTE MAXIMUM RATINGS

Symbol	Parameter		2N6931	2N6932	Unit
V_{CEV}	Collector-emitter Voltage	$V_{BE} = -1.5V$	450	650	V
V_{CEX}	Collector-emitter Voltage		350	450	V
V_{CEO}	Collector-emitter Voltage	$I_B = 0$	300	400	V
V_{EBO}	Emitter-base Voltage	$I_C = 0$	8		V
I_C	Collector Current		10		A
I_{CM}	Collector Peak Current		15		A
I_B	Base Current		5		A
I_{BM}	Base Peak Current		7		A
I_E	Emitter Current		15		A
I_{EM}	Emitter Peak Current		22		A
P_{tot}	Total Dissipation at $T_c < 25^\circ C$		150		W
T_{stg}	Storage Temperature		- 65 to 150		$^\circ C$
T_j	Max. Operating Junction Temperature		150		$^\circ C$

THERMAL DATA

$R_{th\ j-case}$	Thermal Resistance Junction-case	Max	0.83	°C/W
T_L	Maximum Lead Temperature for Soldering Purpose		235	°C

ELECTRICAL CHARACTERISTICS ($T_{case} = 25^\circ\text{C}$ unless otherwise specified)

Symbol	Parameter	Test Conditions	Min.	Typ.	Max.	Unit
I_{CEV}	Collector Cutoff Current	$V_{CE} = V_{CEV}$ $V_{BE} = -1.5V$ $V_{CE} = V_{CEV}$ $V_{BE} = -1.5V$ $T_c = 100^\circ\text{C}$			0.1 1	mA mA
I_{EBO}	Emitter Cutoff Current ($I_C = 0$)	$V_{EB} = 8V$			2	mA
$V_{CEO(sus)}^*$	Collector Emitter Sustaining Voltage	$I_C = 0.2A$ $L = 25mH$ for 2N6931 for 2N6932	300 400			V V
V_{EBO}	Emitter-base Voltage ($I_C = 0$)	$I_E = 50mA$	8			V
$V_{CE(sat)}^*$	Collector-emitter Saturation Voltage	$I_C = 10A$ $I_B = 2A$ $I_C = 10A$ $I_B = 2A$ $T_c = 100^\circ\text{C}$			1 2	V V
$V_{BE(sat)}^*$	Base-emitter saturation Voltage	$I_C = 10A$ $I_B = 2A$ $I_C = 10A$ $I_B = 2A$ $T_c = 100^\circ\text{C}$			1.5 1.5	V V
h_{FE}^*	DC Current Gain	$I_C = 10A$ $V_{CE} = 3V$	8		35	
h_{rfe}	Small Signal Current Gain	$I_C = 1A$ $V_{CE} = 10V$ $f = 5\text{ MHz}$	2		6	
C_{cbo}	Collector-base Capacitance	$V_{CB} = 10V$ $f = 1MHz$	80		300	pF
t_d	RESISTIVE LOAD Delay Time	$V_{CC} = 300V$ $I_C = 10A$			0.1	μs
t_r	Rise Time	$R_C = 30\Omega$ $I_{B1} = -I_{B2} = 2A$			0.7	μs
t_s	Storage Time	$V_{BB} = -5V$ $t_p = 30\mu\text{s}$			2.5	μs
t_f	Fall Time	See fig. 1			0.5	μs
t_s	INDUCTIVE LOAD Storage Time	$V_{CC} = 50V$ $I_C = 10A$			3.5	μs
t_f	Fall Time	$L_C = 150\mu\text{H}$ $I_{B1} = -I_{B2} = 2A$			0.4	μs
t_c	Crossover Time	$R_{BB} = 2.2\Omega$ $V_{clamp} = V_{CEX}$ See fig. 1			0.8	μs
di_c/dt	Turn-on Current Slope	$V_{CC} = 300V$ $I_B = 3A$ $R_C = 0$ $t_p = 3\mu\text{s}$ See fig. 2	50			A/ μs
V_{CEX}	Collector-emitter Sustaining Voltage	$V_{CC} = 50V$ $I_C = 10A$ $L_C = 150\mu\text{H}$ $I_{B1} = -I_{B2} = 2A$ $R_{BB} = 2.2\Omega$ $V_{clamp} = V_{CEX}$ $T_c = 100^\circ\text{C}$ See fig. 3 for 2N6931 for 2N6932	350 450			V V

* Pulsed : Pulse duration = 300 μs , duty cycle = 2%

Figure 1 : Switching Time Measurements.

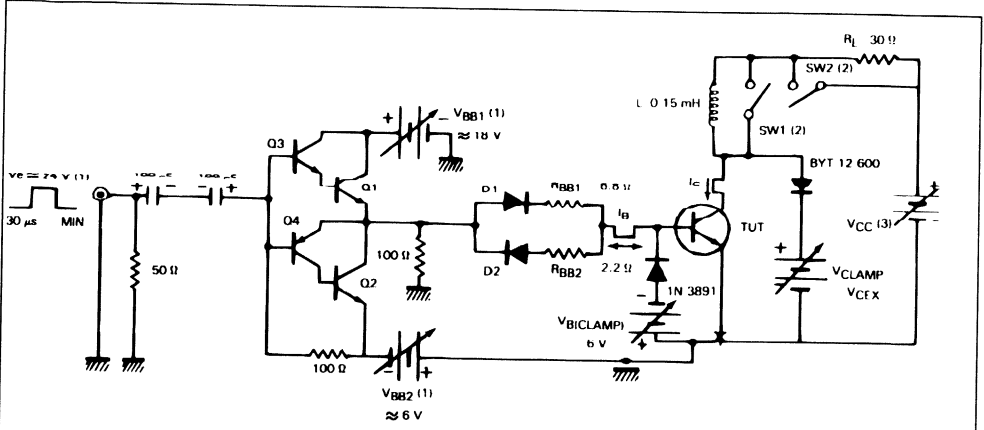

- (1) Adjust for I_{B1} and $I_{B2} \pm 2A$.
- (2) SW1 Closed for t_d , t_r , t_s , t_f , SW1 Open for t_c
SW2 Closed for t_c , Open for t_d , t_s , t_f .
- (3) $V_{CC} : 300V$ for t_d , t_r , t_s , t_f
 $V_{CC} : 50V$ for t_c .

- Q1, Q2 BUT60
- Q3 BD243
- Q4 BD244
- D1, D2 BYW100

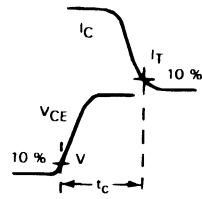
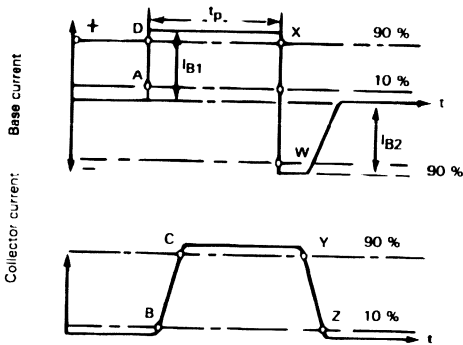

- t_d A-B transition A-D : $\leq 0.3\mu s$
- t_r B-C transition X-W : $\leq 0.3\mu s$
- t_s X-Y
- t_f Y-Z
- t_c V-I

Figure 2 : Turn-on Switching Waveforms.

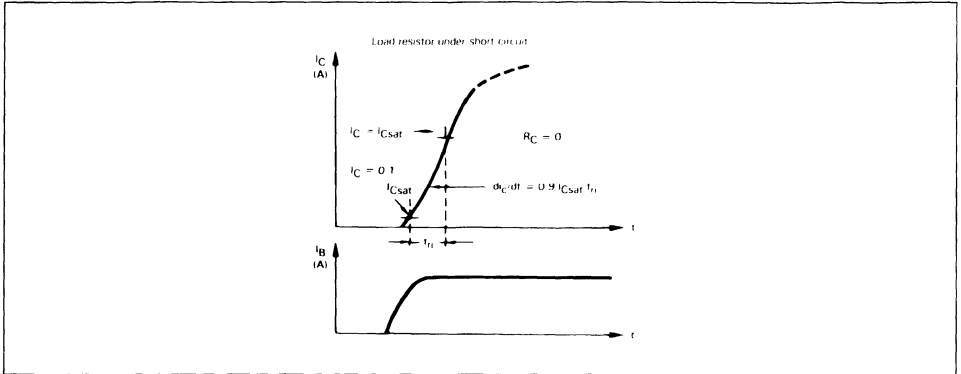
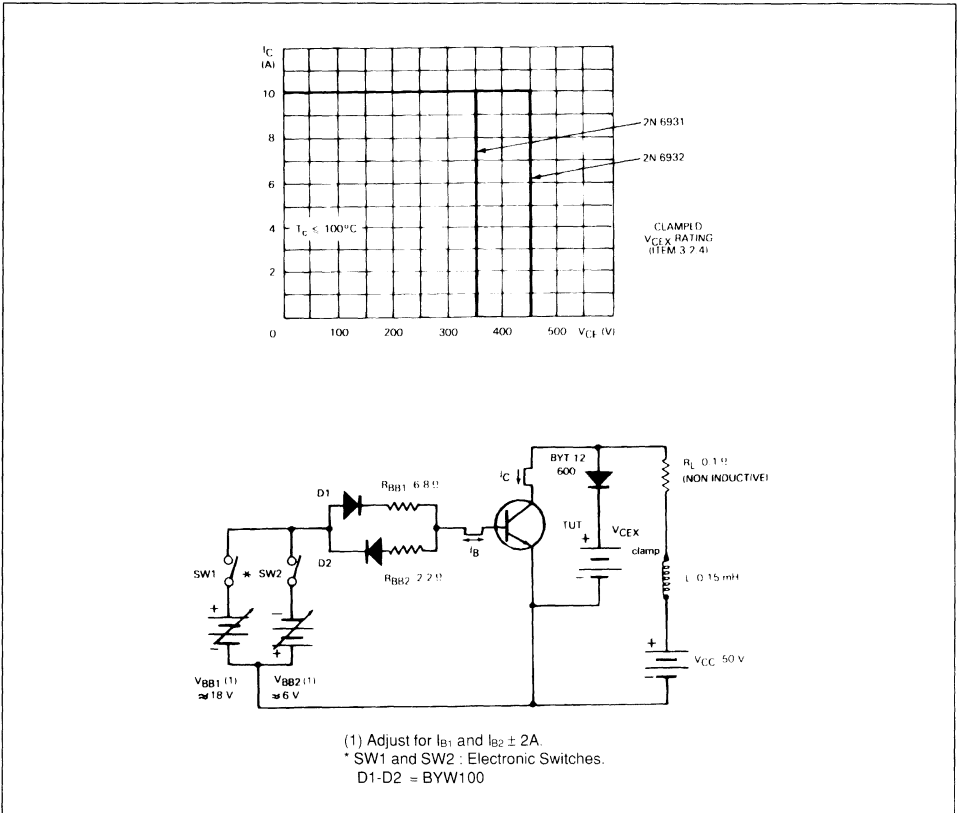
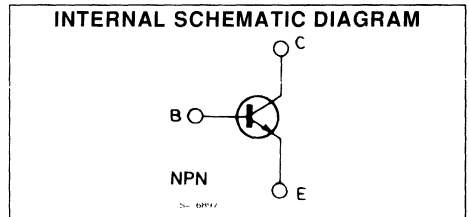
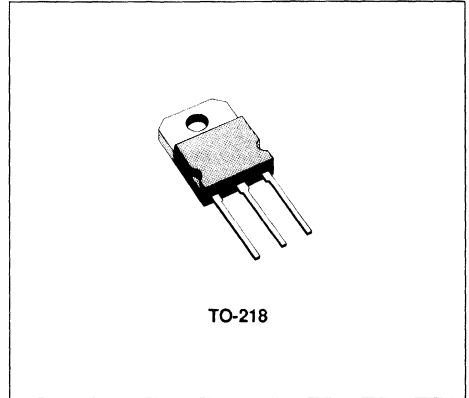

Figure 3 : Maximum Operating Conditions for Switching between Saturation and Cut off.



NPN HIGH VOLTAGE POWER TRANSISTORS

- OFF-LINE POWER SUPPLIES
- HIGH VOLTAGE INVERTERS
- SWITCHING REGULATORS



DESCRIPTION

High voltage, high speed, switching power transistors suited for use on medium voltage supply.

ABSOLUTE MAXIMUM RATINGS

Symbol	Parameter		2N6933	2N6934	2N6935	Unit
V_{CEV}	Collector-emitter Voltage	($V_{BE} = -1.5\text{ V}$)	450	550	650	V
V_{CEX}	Collector-emitter Voltage		350	400	450	V
V_{CEO}	Collector-emitter Voltage	($I_B = 0$)	300	350	400	V
V_{EBO}	Emitter-base Voltage	($I_C = 0$)	8			V
I_C	Collector Current		15			A
I_{CM}	Collector Peak Current		23			A
I_B	Base Current		5			A
I_{BM}	Base Peak Current		7			A
I_E	Emitter Current		20			A
I_{EM}	Emitter Peak Current		30			A
P_{tot}	Total Dissipation at $T_C < 25\text{ }^\circ\text{C}$		175			W
T_{stg}	Storage Temperature		- 65 to 150			$^\circ\text{C}$
T_j	Max. Operating Junction Temperature		150			$^\circ\text{C}$

THERMAL DATA

$R_{th\ j-case}$	Thermal Resistance Junction-case	Max.	0.71	°C/W
T_L	Maximum Lead Temperature for Soldering Purpose		235	°C

ELECTRICAL CHARACTERISTICS ($T_{case} = 25\ ^\circ C$ unless otherwise specified)

Symbol	Parameter	Test Conditions	Min.	Typ.	Max.	Unit
I_{CEV}	Collector Cutoff Current	$V_{CE} = V_{CEV}$ $V_{BE} = -1.5\ V$ $V_{CE} = V_{CEV}$ $V_{BE} = -1.5\ V$ $T_c = 100\ ^\circ C$			0.1 1	mA mA
I_{EBO}	Emitter Cutoff Current ($I_C = 0$)	$V_{EB} = 8\ V$			2	mA
$V_{CE0(sus)}$	Collector Emitter sustaining Voltage	$I_C = 0.2\ A$ $L = 25\ mH$ for 2N6933 for 2N6934 for 2N6935	300 350 400			V V V
V_{EBO}	Emitter-base Voltage ($I_C = 0$)	$I_E = 50\ mA$	8			V
$V_{CE(sat)}$	Collector-emitter Saturation Voltage	$I_C = 15\ A$ $I_B = 3\ A$ $I_C = 15\ A$ $I_B = 3\ A$ $T_c = 100\ ^\circ C$			1 2	V V
$V_{BE(sat)}$	Base-emitter Saturation Voltage	$I_C = 15\ A$ $I_B = 3\ A$ $I_C = 15\ A$ $I_B = 3\ A$ $T_c = 100\ ^\circ C$			1.5 1.5	V V
h_{FE}	DC Current Gain	$I_C = 15\ A$ $V_{CE} = 3\ V$	8		35	
h_{fe}	Small Signal Current Gain	$I_C = 1\ A$ $V_{CE} = 10\ V$ $f = 5\ MHz$	2		6	
C_{cbo}	Collector-base Capacitance	$V_{CB} = 10\ V$ $f = 1\ MHz$	150		400	pF
t_d t_r t_s t_f	Delay Time Rise Time Storage Time Fall time	RESISTIVE LOAD $V_{CC} = 300\ V$ $I_C = 15\ A$ $R_C = 20\ \Omega$ $I_{B1} = -I_{B2} = 3\ A$ $V_{BB} = -5\ V$ $t_p = 30\ \mu s$ see fig. 1			0.1 0.7 2.5 0.5	μs μs μs μs
t_s t_f t_c	Storage Time Fall Time Crossover Time	INDUCTIVE LOAD $V_{CC} = 50\ V$ $I_C = 15\ A$ $L_C = 100\ \mu H$ $I_{B1} = -I_{B2} = 3\ A$ $R_{BB} = 1.5\ \Omega$ $V_{clamp} = V_{CEX}$ $T_c = 100\ ^\circ C$ see fig. 1			3.5 0.4 0.8	μs μs μs
di_c/dt	Turn-on Current Slope	$V_{CC} = 300\ V$ $I_B = 4.5\ A$ $R_C = 0$ $t_p = 3\ \mu s$ see fig. 2	75			A/ μs
V_{CEX}	Collector-emitter Sustaining Voltage	$V_{CC} = 50\ V$ $I_C = 15\ A$ $L_C = 100\ \mu H$ $I_{B1} = -I_{B2} = 3\ A$ $R_{BB} = 1.5\ \Omega$ $V_{clamp} = V_{CEX}$ $T_c = 100\ ^\circ C$ see fig. 3 for 2N6933 for 2N6934 for 2N6935	350 400 450			V V V

* Pulse duration = 300 μs , duty cycle 2 %.

Figure 1 : Switching Time Measurements.

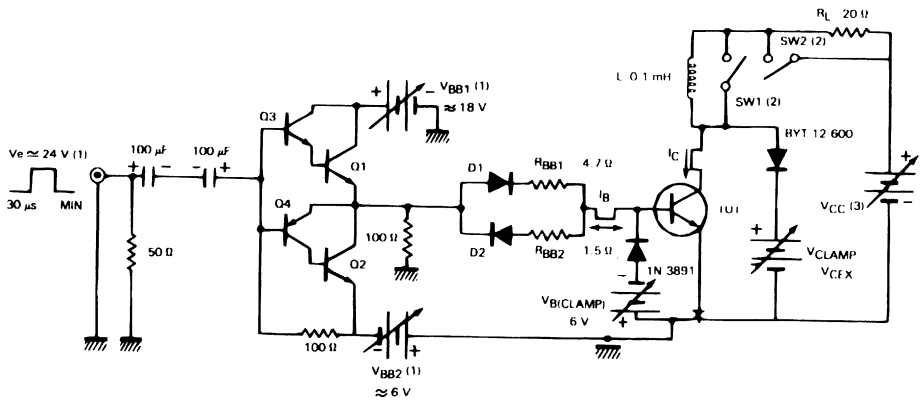

- (1) Adjust for I_{B1} and $I_{B2} \pm 3A$.
- (2) SW1 Closed for t_d , t_r , t_s , t_f ; SW1 Open for t_c .
SW2 Closed for t_c ; Open for t_d , t_r , t_s , t_f .
- (3) $V_{CC} : 300V$ for t_d , t_r , t_s , t_f .
 $V_{CC} : 50V$ for t_c .

- Q1, Q2 BUT60
- Q3 BD243
- Q4 BD244
- D1, D2 BYW100

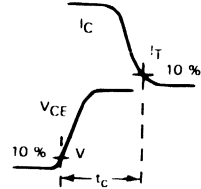
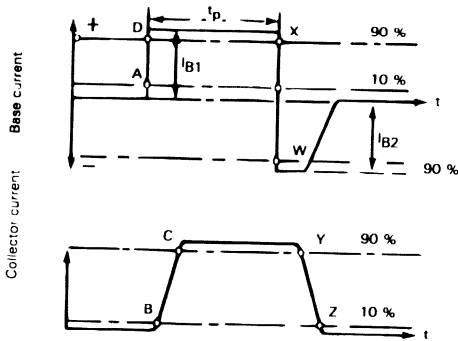

t_d A-B transition A-D : $\sigma \leq 0.3\mu s$
 t_r B-C transition X-W : $\leq 0.3\mu s$
 t_s X-Y
 t_f Y-Z
 t_c V-I

Figure 2 : Turn-on Switching Waveforms.

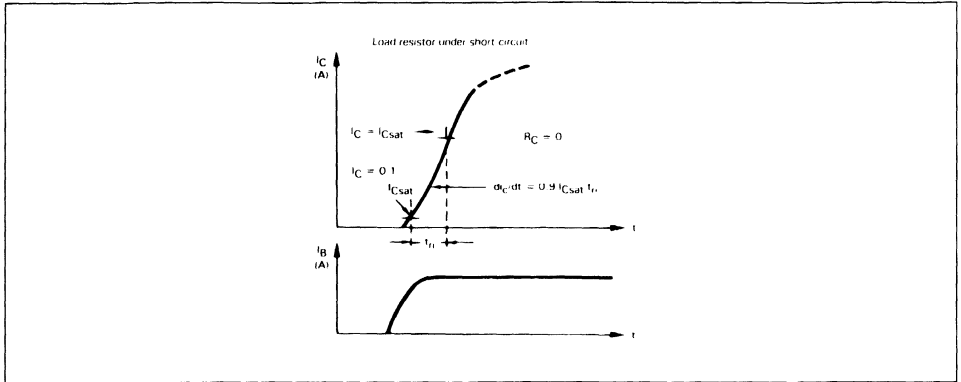
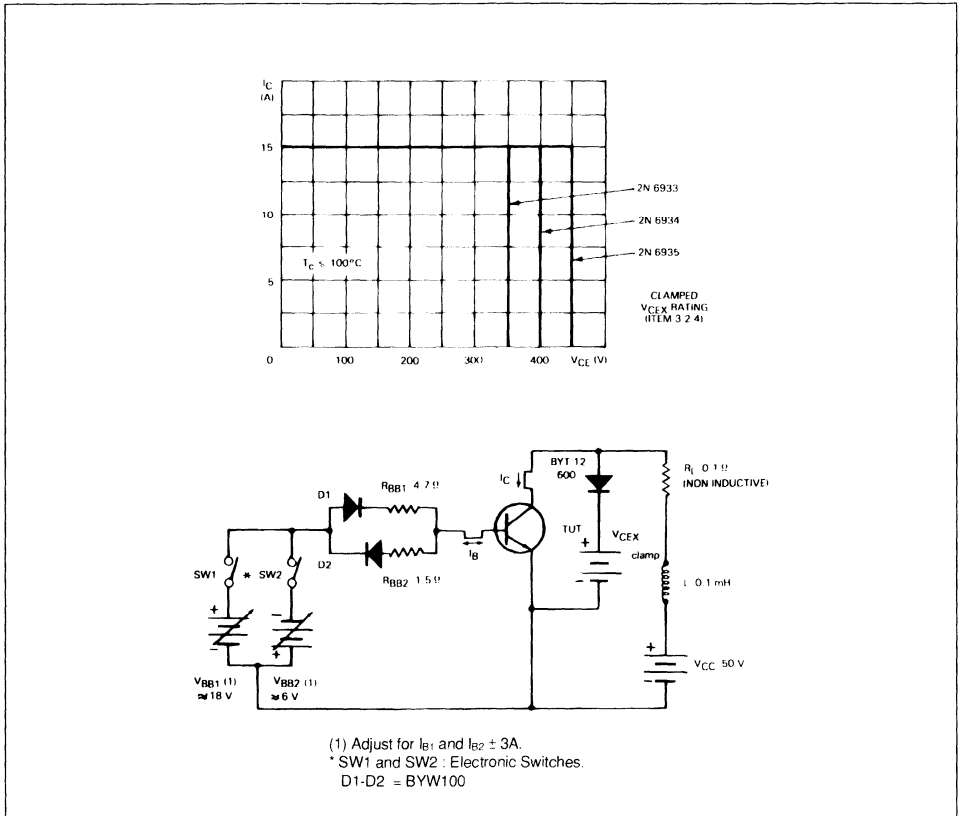
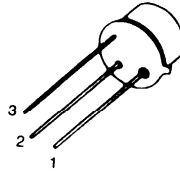

Figure 3 : Maximum Operating Conditions for Switching between Saturation and Cut off.



PACKAGES

TO-39



MECHANICAL DATA

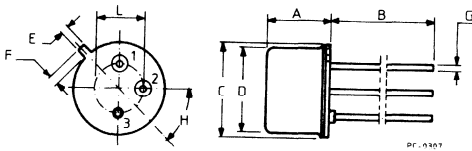

	DIMENSIONS			
	mm		inches	
	min	max	min	max
A	—	6.6	—	0.260
B	12.7	—	0.500	—
C	—	9.4	—	0.370
D	—	8.5	—	0.334
E	—	0.9	—	0.035
F	—	1.2	—	0.047
G	—	0.49	—	0.019
H	45° typ		45° typ	
L	5.08 typ		0.200 typ	

pin 1: Emitter - pin 2: Base - pin 3: Collector

SOT-32

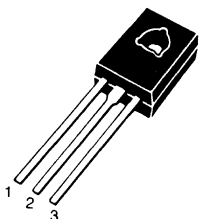

MINIATURE PACKAGE
WITH REVERSED
TO-220 PINOUT

MECHANICAL DATA

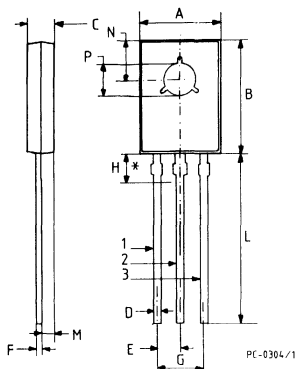

	DIMENSIONS			
	mm		inches	
	min	max	min	max
A	7.4	7.8	0.295	0.307
B	10.5	10.8	0.413	0.425
C	2.4	2.7	0.094	0.106
D	0.7	0.9	0.027	0.035
E	2.2 typ.		0.087 typ.	
F	0.49	0.75	0.019	0.029
G	4.4 typ.		0.173 typ.	
H	2.54 typ.		0.100 typ.	
L	15.7 typ.		0.618 typ.	
M	1.2 typ.		0.047 typ.	
N	3.8 typ.		0.149 typ.	
P	3.0	3.2	0.118	0.126

pin 1: Emitter - pin 2: Collector - pin 3: Base

*: WITHIN THIS REGION THE
CROSS-SECTION OF THE LEADS IS
UNCONTROLLED

SOT-82

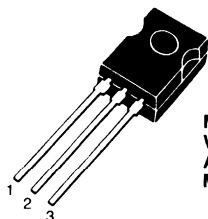

MINIATURE PACKAGE
WITH SAME PINOUT
AS TO-220 IDEAL FOR
MOUNTING WITH CLIPS

MECHANICAL DATA

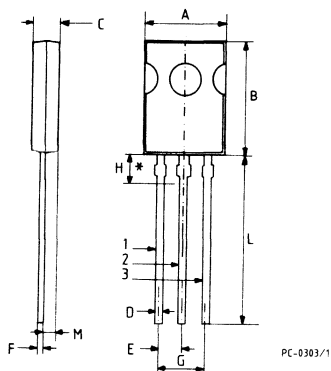

	DIMENSIONS			
	mm		inches	
	min	max	min	max
A	7.4	7.8	0.295	0.307
B	10.5	10.8	0.413	0.425
C	2.4	2.7	0.094	0.106
D	0.7	0.9	0.027	0.035
E	2.2 typ.		0.087 typ.	
F	0.49	0.75	0.019	0.029
G	4.4 typ.		0.173 typ.	
H	2.54 typ.		0.100 typ.	
L	15.7 typ.		0.618 typ.	
M	1.2 typ.		0.047 typ.	

pin 1: Base - pin 2: Collector - pin 3: Emitter

*: WITHIN THIS REGION THE
CROSS-SECTION OF THE LEADS IS
UNCONTROLLED

SOT-194

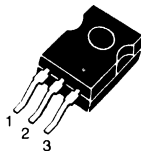

LEAD FORMED
SOT-82 FOR SURFACE
MOUNTING ASSEMBLY

MECHANICAL DATA

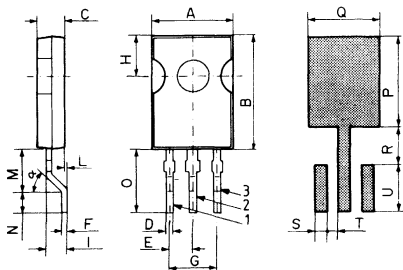

PC-0276/1

	DIMENSIONS			
	mm		inches	
	min	max	min	max
A	7.4	7.8	0.295	0.307
B	10.5	10.8	0.413	0.425
C	2.4	2.7	0.094	0.106
D	0.7	0.9	0.027	0.035
E	2.2 typ.		0.087 typ.	
F	0.45	0.65	0.017	0.026
G	4.4 typ.		0.173 typ.	
H	3.8 typ.		0.149 typ.	
I	1.8 typ.		0.070 typ.	
L	0.1 typ.		0.004 typ.	
M	3.8	4.2	0.149	0.165
N	2 typ.		0.078 typ.	
O	6 typ.		0.236 typ.	
α	45°		45°	
P	8.5 typ.		0.334 typ.	
Q	6.7 typ.		0.263 typ.	
R	3.5 typ.		0.137 typ.	
S	1.2 typ.		0.047 typ.	
T	1 typ.		0.039 typ.	
U	4.5 typ.		0.177 typ.	

pin 1: Base - pin 2: Collector - pin 3: Emitter

TO-220

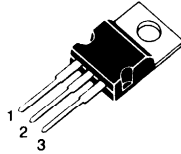

MECHANICAL DATA

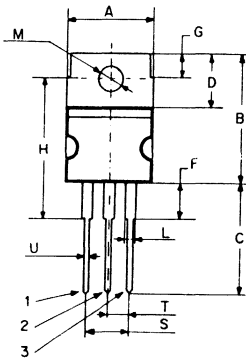

PC-0277



	DIMENSIONS			
	mm		inches	
	min	max	min	max
A	10	10.4	0.393	0.409
B	15.2	15.9	0.598	0.626
C	12.7	13.7	0.500	0.539
D	6.2	6.6	0.244	0.260
E	4.4	4.6	0.173	0.181
F	3.5	5.5	0.137	0.216
G	2.65	2.95	0.104	0.116
H	17.6 typ.		0.692 typ.	
L	1.14	1.7	0.044	0.067
M	3.75	3.85	0.147	0.151
N	1.23	1.32	0.048	0.051
P	0.41	0.64	0.016	0.025
R	2.4	2.72	0.094	0.107
S	4.95	5.15	0.194	0.203
T	2.4	2.7	0.094	0.106
U	0.61	0.94	0.024	0.037

pin 1: Base - pin 2: Collector - pin 3: Emitter

ISOWATT220

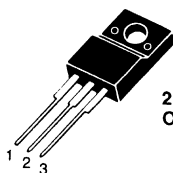

2000V DC FULLY ISOLATED VERSION OF THE TO-220 PACKAGE

MECHANICAL DATA

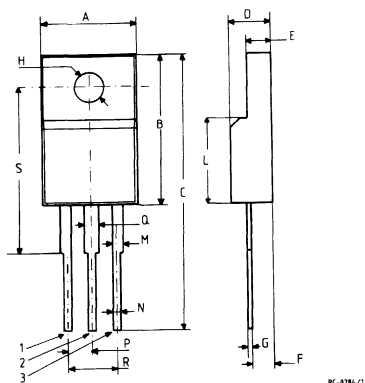

	DIMENSIONS			
	mm		inches	
	min	max	min	max
A	10	10.4	0.393	0.409
B	15.9	16.4	0.626	0.645
C	28.6	30.6	1.126	1.204
D	4.4	4.6	0.173	0.181
E	2.5	2.7	0.098	0.106
F	2.4	2.75	0.094	0.108
G	0.4	0.7	0.015	0.027
H	3	3.2	0.118	0.126
L	9	9.3	0.354	0.366
M	1.15	1.7	0.045	0.067
N	0.75	1	0.030	0.039
P	2.4	2.7	0.094	0.106
Q	1.15	1.7	0.045	0.067
R	4.95	5.2	0.195	0.204
S	16 typ		0.630 typ	

pin 1: Base - pin 2: Collector - pin 3: Emitter

TO-218 (SOT-93)

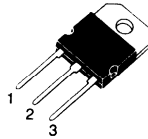

MECHANICAL DATA

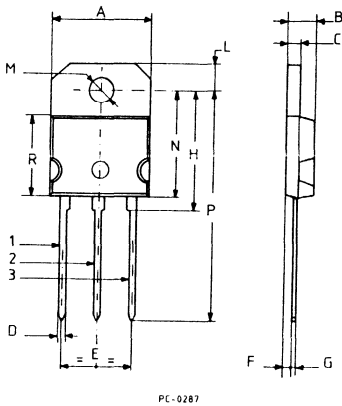

	DIMENSIONS			
	mm		inches	
	min	max	min	max
A	14.7	15.2	0.578	0.598
B	4.7	4.9	0.185	0.193
C	1.9	2.1	0.075	0.082
D	1.1	1.3	0.043	0.051
E	10.8	11.1	0.425	0.437
F	2.5 typ		0.098 typ	
G	0.5	0.78	0.019	0.030
H	18 typ		0.708 typ	
L	3.95	4.15	0.155	0.163
M	4	4.1	0.157	0.161
N	—	16.2	—	0.637
P	31 typ		1.220 typ	
R	—	12.2	—	0.480

pin 1: Base - pin 2: Collector - pin 3: Emitter

ISOWATT218

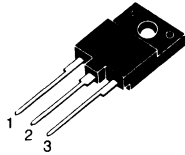

4000V DC FULLY ISOLATED
VERSION OF THE TO-218
PACKAGE CONFORMS TO UL AND
VDE SAFETY STANDARDS

MECHANICAL DATA

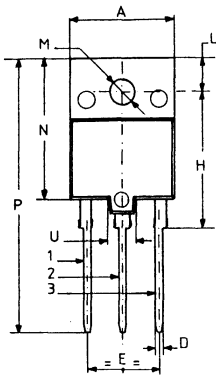

PC-0288

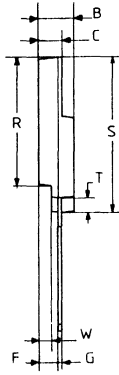

	DIMENSIONS			
	mm		inches	
	min	max	min	max
A	15.8	16.2	0.622	0.637
B	5.35	5.65	0.210	0.222
C	3.3	3.8	0.130	0.149
D	1.05	1.25	0.041	0.049
E	10.8	11.2	0.425	0.441
F	2.9	3.1	0.114	0.122
G	0.45	1	0.017	0.039
H	20.25	20.75	0.797	0.817
L	4.85	5.25	0.190	0.206
M	3.5	3.7	0.137	0.145
N	20.8	21.2	0.818	0.834
P	40.5	42.5	1.594	1.673
R	19.1	19.9	0.752	0.783
S	22.8	23.6	0.897	0.929
T	2.1	2.3	0.082	0.090
U	4.6 typ.		0.181 typ.	
W	1.88	2.08	0.074	0.081

pin 1: Base - pin 2: Collector - pin 3: Emitter

TOP-3I

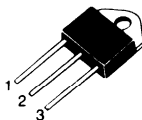

MECHANICAL DATA

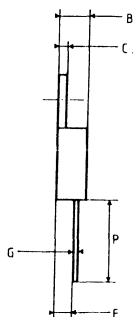
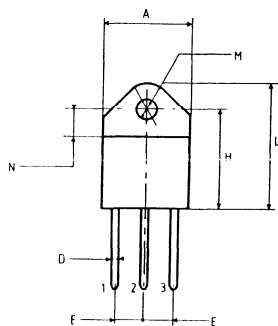

PC-0302

	DIMENSIONS			
	mm		inches	
	min	max	min	max
A	15.2	15.4	0.598	0.606
B	4.4	4.5	0.173	0.177
C	1.45	1.55	0.057	0.061
D	1.2	1.4	0.047	0.055
E	5.5 typ.		0.216 typ.	
G	0.5	—	0.019	—
H	16.1	16.5	0.633	0.649
L	20.7	21.1	0.815	0.830
M	4.1	4.2	0.161	0.165
N	3.4	—	0.133	—
P	15	15.6	0.590	0.614

pin 1: Base - pin 2: Collector - pin 3: Emitter

TO-3

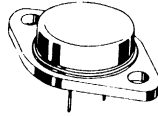

MECHANICAL DATA

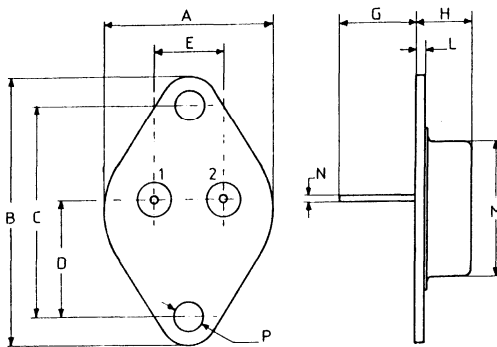

PC-0285A

	DIMENSIONS			
	mm		inches	
	min	max	min	max
A	25	26	0.984	1.023
B	38.5	39.3	1.515	1.547
C	30	30.3	1.181	1.193
D	16.5	17.2	0.649	0.677
E	10.7	11.1	0.421	0.437
G	11	13.1	0.433	0.515
H	8.32	8.92	0.327	0.351
L	1.5	1.65	0.059	0.065
M	19	20	0.748	0.787
N	0.97	1.15	0.038	0.045
P	4	4.09	0.157	0.161

pin 1: Base - pin 2: Emitter - pin 3: Collector

NOTES

NOTES

SALES OFFICES

AUSTRALIA

NSW 2027 EDGECLIFF
Suite 211, Edgecliff centre
203-233, New South Head Road
Tel. (61-2) 327.39.22
Telex: 071 126911 TCAUS
Telefax: (61-2) 327.61.76

BRAZIL

05413 SÃO PAULO
R. Henrique Schaumann 286-CJ33
Tel. (55-11) 883-5455
Telex: (39-11) 37988 "UMBR BR"

CANADA

BRAMPTON, ONTARIO
341 Main St. North
Tel. (416) 455-0505
Telefax: 416-455-2606

CHINA

BEIJING
Beijing No. 5 Semiconductor
Device Factory
14 Wu Lu Tong Road
Da Shang Mau War
Tel. (86-1) 2024378
Telex 222722 STM CH

DENMARK

2730 HERLEV
Herlev Torv, 4
Tel. (45-2) 94.85.33
Telex: 35411
Telefax: (45-2) 948694

FRANCE

94253 GENTILLY Cedex
7 - avenue Gallieni - BP. 93
Tel.: (33-1) 47.40.75.75
Telex: 632570 STMHQ
Telefax: (33-1) 47.40.79.10

67000 STRASBOURG

20, Place des Halles
Tel. (33) 88.25.49.90
Telex: 870001F
Telefax: (33) 88.22.29.32

HONG KONG

WANCHAI
22nd Floor - Hopewell centre
183 Queen's Road East
Tel. (852-5) 8615788
Telex: 60955 ESGIES HX
Telefax: (852-5) 8656589

INDIA

NEW DELHI 110048
Liason Office
S114, Greater Kailash Part 2
Tel. (91) 6414537
Telex: 31-62000 SGSS IN

ITALY

20090 ASSAGO (MI)
V.le Milanofiori - Strada 4 - Palazzo A/4/A
Tel. (39-2) 89213.1 (10 linee)
Telex: 330131 - 330141 SGSAGR
Telefax: (39-2) 8250449

40033 CASALECCHIO DI RENO (BO)

Via R. Fucini, 12
Tel. (39-51) 591914
Telex: 512442
Telefax: (39-51) 591305

00161 ROMA

Via A. Torlonia, 15
Tel. (39-6) 8443341/2/3/4/5
Telex: 620653 SGSATE I
Telefax: (39-6) 8444474

JAPAN

TOKYO 141
Shinagawa-Ku, Nishi Gotanda
8-11-7, Collins Bldg 8
Tel. (81-3) 491 8611
Telefax: (81-3) 491-8735

KOREA

SEOUL 121
8th floor Shinwon Building
823-14, Yuksam-Dong
Kang-Nam-Gu
Tel. (82-2) 553-0399
Telex: SGSKOR K29998
Telefax: (82-2) 552-1051

NETHERLANDS

5612 AM EINDHOVEN
Dillenburgstraat 25
Tel.: (31-40) 550015
Telex: S1186
Telefax: (31-40) 528835

SINGAPORE

SINGAPORE 2056
28 Ang Mo Kio - Industrial Park 2
Tel. (65) 4821411
Telex: RS 55201 ESGIES
Telefax: (65) 4820240

SPAIN

08021 BARCELONA
Calle Platon, 6 4th Floor, 5th Door
Tel. (34-3) 2022017-2020316
Telefax: (34-3) 2021461

28027 MADRID

Calle Albacete, 5
Tel. (34-1) 4051615
Telex: 27060 TCCEE
Telefax: (34-1) 4031134

SWEDEN

S-16421 KISTA
Borgarfjordsgatan, 13 - Box 1094
Tel.: (46-8) 7939220
Telex: 12078 THSW S
Telefax: (46-8) 7504950

SWITZERLAND

1218 GRAND-SACONNEX (GENÈVE)
Chemin François-Lehmann, 18/A
Tel. (41-22) 7986462
Telex: 415493 STM CH
Telefax: (41-22) 7984869

TAIWAN

KAOHSIUNG
7FL-2 No
5 Chung Chen 3rd Road
Tel. (886-7) 2011702
Telefax: (886-7) 2011703

TAIPEI

12th Floor
571, Tun Hua South Road
Tel. (886-2) 755-4111
Telex: 10310 ESGIE TW
Telefax: (886-2) 755-4008

UNITED KINGDOM

MARLOW, BUCKS
Planar House, Parkway
Globe Park
Tel.: (44-628) 890800
Telex: 847458
Telefax: (44-628) 890391

U.S.A.

NORTH & SOUTH AMERICAN
MARKETING HEADQUARTERS
1000 East Bell Road
Phoenix, AZ 85022
(1)(602) 867-6100

SALES COVERAGE BY STATE

AL

Huntsville - (205) 533-5995

AZ

Phoenix - (602) 867-6340

CA

Irvine - (714) 250-0455
San José - (408) 452-8585

CO

Boulder (303) 449-9000

IL

Schaumburg - (312) 517-1890

IN

Kokomo - (317) 459-4700

MA

Waltham - (617) 890-6688

MI

Southfield - (313) 358-4250

NC

Raleigh - (919) 832-7775

NJ

Voorhees - (609) 772-6222

NY

Poughkeepsie - (914) 454-8813

OR

Tigard - (503) 620-5517

TX

Austin - (512) 339-4191
Carrollton - (214) 466-8844

WA

Seattle - (206) 524-6421

FOR RF AND MICROWAVE
POWER TRANSISTORS CONTACT
THE FOLLOWING REGIONAL
OFFICES IN THE U.S.A.

CA

Hawthorne - (213) 675-0742

NJ

Totowa - (201) 890-0884

PA

Montgomeryville - (215) 362-8500

TX

Carrollton - (214) 466-8844

WEST GERMANY

6000 FRANKFURT M1

Gulleutstraße 322
Tel. (49-69) 237492
Telex: 176997 689
Telefax: (49-69) 231957
Teletex: 6997689 = STVBP

8011 GRASBRUNN

Bretonischer Ring 4
Neukelerloh Technopark
Tel. (49-89) 460060
Telex: 528211
Telefax: (49-89) 4605454
Teletex: 897107 = STDISTR

3000 HANNOVER 1

Eckenerstraße 5
Tel. (49-511) 634191
Telex 175118418
Teletex: 5118418 csfbeh
Telefax: (49-511) 633552

8500 NÜRNBERG 20

Erlenstegenstraße. 72
Tel. (49-911) 597032
Telex: 626243
Telefax: (49-911) 5980701

5200 SIEGBURG

Frankfurter Str. 22a
Tel. (49-2241) 660 84-86
Telex: 889510
Telefax: (49-2241) 67584

7000 STUTTGART 1

Oberer Kirchhaldenweg 135
Tel. (49-711) 692041
Telex: 721718
Telefax: (49-711) 691408

Information furnished is believed to be accurate and reliable. However, SGS-THOMSON Microelectronics assumes no responsibility for the consequences of use of such information nor for any infringement of patents or other rights of third parties which may result from its use. No license is granted by implication or otherwise under any patent or patent rights of SGS-THOMSON Microelectronics. Specifications mentioned in this publication are subject to change without notice. This publication supersedes and replaces all information previously supplied. SGS-THOMSON Microelectronics products are not authorized for use as critical components in life support devices or systems without express written approval of SGS-THOMSON Microelectronics.

Cover design by Keith & Koppel, Segrate, Italy
Typesetting and layout on Desk Top Publishing
by AZIMUT, Hénin Bt., France
Printed by Garzanti, Cernusco S./N., Italy

© 1989 SGS-THOMSON Microelectronics — All Rights Reserved

SGS-THOMSON Microelectronics GROUP OF COMPANIES
Australia · Brazil · China · France · Hong Kong · Italy · Japan · Korea · Malaysia · Malta · Morocco · The Netherlands ·
Singapore · Spain · Sweden · Switzerland · Taiwan · United Kingdom · U.S.A. · West Germany